



ELEMENTY ZŁĄCZNE ZE STALI NIERDZEWNEJ

1 Allgemeine Informationen
General Information



2 Schlaucharmaturen ohne Ausreissssicherung
Hose Couplings without Wire Trap Area

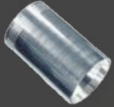

3 Schlaucharmaturen mit Ausreissssicherung –
Interlock Serie
Hose Couplings with Wire Trap Area – Interlock Series



4 Schlaucharmaturen – Schraubausführung
Screw-Hose Couplings



5 Adapter – BSP – Metrisch – NPT – Kegelig
Adaptors – BSP – Metric – NPT – Taper



6 Bördelanschlüsse und Adapter 37°
Flare Couplings and Adaptors 37°



7 Bördelanschlusssteile für Verschraubungsstutzen
mit 24°-Innenkonus
Flare Coupling Parts for Coupling Bodies with 24°-Cone



8 Schneidringverschraubungen
Cone Sealing Couplings



9 Dichtkegel-Verschraubungen mit 24°-Kegel
und O-Ring – Viton
Cone Sealing Couplings with 24°-Cone and O-ring – Viton



10 Schweißkegel-Verschraubungen mit O-Ring
Weld Nipple Couplings with O-ring



11 Winkel-Drehverschraubungen
Elbow Rotary Couplings



12 Vormontagegestutzen und Schmierstoffe
Pre-Installation Dies and Lubricants



13 Kugelhähne und Absperrventile
Ball Valves and Spindle Valves



14 Messanschlüsse
Pressure Gauge Connectors



15 Steckkupplungen und Schraubkupplungen
Push and Pull Couplings and Screw Couplings



16 Rohrbogen
Tube Bends



17 Hydraulik- und PTFE-Schläuche /
Montagevorschriften
Hydraulic- and PTFE-Hoses / Instruction for Installation



Allgemeine Informationen General Information



1.0 Allgemeines

Funktionsbeschreibung der Rohrverschraubungen

Ausgangsbasis sind die Verschraubungen nach DIN 2353 / DIN EN ISO 8434-1 mit Bohrungsform W DIN 3861 (24°-Konus) und deren Stutzen als Standardbauelemente. Funktionelle und dichte Verbindungen zwischen Stutzen stellen grundsätzlich nachfolgende Verschraubungsarten dar, wobei die Auswahl den technischen Bedürfnissen angepasst werden sollte. Bei gleichen Stutzen ist eine Austauschbarkeit unserer verschiedenen Systeme rohranschlussseitig möglich.

2.0 Zweikantenschneidring-Verschraubungen

Bei Anzug der Überwurfmutter greift zunächst die vordere Schneidkante in das Rohr ein und bei weiterem Anzug die zweite Schneidkante. Nach Beendigung der funktionellen Einschnitte der Schneidkanten ist, bedingt durch die konstruktive Formgebung des Schneidringes, eine weitere Eindringtiefe begrenzt. Gleichzeitig hat sich das Verkeilen des Ringes zwischen Rohr und Stutzen vollzogen. Sowohl in radialer als auch in axialer Richtung ist hierdurch Formschlüssigkeit erreicht worden.

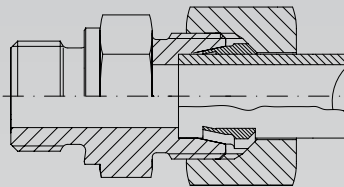

Vor dem Anzug der Überwurfmutter
Before the union nut is tightened

Durch die Profilgebung und hohe Formschlüssigkeit werden auftretende Kräfte auf der gesamten Konuslänge günstig verteilt. Hierdurch wird eine optimale Schwingungssicherheit, hohe Sicherheit gegen Biegewechselspannungen sowie Druck- und Temperaturschwankungen erreicht.

Aufgrund der hohen Oberflächengüte sind relativ günstige Anziehdrehmomente erreichbar. Die Gefahr einer „Übermontage“ ist durch den spürbar starken Anstieg des Momentes (nach funktionsgerechtem Eingriff der Schneidkanten) deutlich erkennbar. Eine leichte „Übermontage“ beeinträchtigt die Gesamtfunktion nicht.

3.0 Bördelverschraubungen mit Zwischenadapter

Durch die Bördelverschraubung wird eine sichere Verbindung zwischen Stutzen mit Bohrungsform W DIN 3861 und 37° gebördelten Rohrenden erreicht. Die Montage ist einfach und beliebig wiederholbar. Der Zwischenring (mit eingelegten O-Ringen) wird bis zum spürbaren Anschlag in den Stutzen eingeführt. Durch seine Form sitzt er leicht klemmend im Stutzen fest. Bei Anzug der Überwurfmutter drückt der Druckring an die vorgeformte Bördelung des Rohres, die sich andererseits an dem 37°-Konus des Kegelringes anpresst.

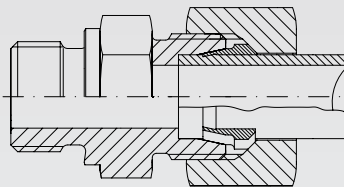

Nach dem Anzug der Überwurfmutter
After the union nut is tightened

1.0 General Information

Description of Function of Screwed Pipe Connections

This screwed pipe connections are based on screwed connections according to DIN 2353 / DIN EN ISO 8434-1 with bore hole shape W DIN 3861 (24°-cone) and the corresponding connection pieces, these elements are used as standard components. The screwed connection types described in the following all represent functional, tight connections between connection piece and pipe. The selection described must be adapted to the specific technical requirements. When the same connection pieces are used, the various PH systems can be exchanged on the pipe connection side.

2.0 Double-Edge Cutting Ring Screw Connections

The use of a double-edge cutting ring offers advantages for most requirements. When the union nut is tightened, first the front cutting edge and then the second edge cuts into the pipe when the union nut is tightened further. After the functional cuts of the cutting edges have been completed, cutting depth is limited by the cutting ring design. At the same time, the ring has become wedge between the pipe and the connection piece. Positive locking of the components is attained in this case in both radial and axial directions.

Due to the profile shape and highly positive locking, forces applied to the connection are distributed over the entire length of the cone. This provides optimum protection against vibrations, alternating bending stress and fluctuations in pressure and temperature.

Due to the high surface quality, a relatively advantageous tightening moment can be attained. The risk of „over-tightening“ is reduced due to the noticeably heightened increase of the tightened moment (after the cutting edges have properly cut into the pipe). Slightly „over-tightening“ does not impair overall function.

3.0 Flare-Coupling with O-ring Adaptors

This flare-coupling connection provides a secure connection between connection pieces with bore hole shape W DIN 3861 and 37° flared pipe ends. Assembly is easy and can be repeated as often as required. The tapered ring (with inserted o-rings) is inserted into the connection piece until the stop is felt. Due to the shape of the tapered ring, it is lightly wedged into the connection piece. When the union nut is tightened, the thrust collar presses against the pre-formed 37° of the pipe, which in turn presses against the 37° taper of the tapered ring.

Durch die metallisch / elastomere Abdichtung ist eine denkbar sichere Funktion gewährleistet. Die komplette Verschraubung hält hohen Belastungen stand und sichert Biege- wechsellmomente und Schwingungen ab. Auch höhere Temperaturschwankungen beeinträchtigen die Funktion nicht.

Es sind jedoch die zulässigen Höchst-temperaturen der verwendeten Dichtungswerkstoffe zu beachten. Dies gilt bei allen Verschraubungen mit elastomerer Abdichtung!

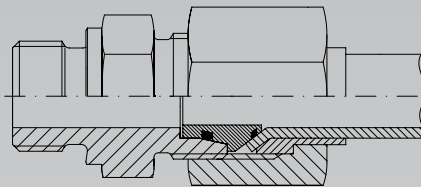

Extremely reliable function is ensured by the metallic / elastomer seal. The entire screwed connection can withstand high loads and absorbs alternating bending moments and vibrations. Greater fluctuations in temperature do not influence function.

The maximum permissible temperatures of the materials used must be taken into consideration. This applies to all screwed connections with elastomer seals.

4.0 Schweißkegelverschraubungen

Die Rohrverschraubung mittels Schweißkegel stellt die sinnvolle Ergänzung zu den Schneidringverschraubungen dar. Es sind die gleichen Stutzen gemäß Bohrungsform W DIN 3861 und entsprechende Überwurfmuttern einsetzbar, so dass sich eine gleiche Bauhöhe ergibt.

Eine sichere und dichte Verbindung zwischen Schweißkegel und Stutzen ist durch die metallische Abdichtung und zusätzlich eingesetzten O-Ring gegeben. Sie hält auch extremen Belastungen, insbesondere Druckstößen, Schwingungen und Temperaturschwankungen stand.

Achtung!

Der O-Ring darf erst nach Verschweißung des Schweißkegels eingelegt werden!

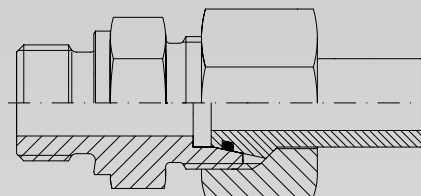

4.0 Welding Cone-Couplings

Screwed pipe connections employing welding cones is a logical supplement to the cutting ring screw connections. The same connection pieces with bore hole shape W DIN 3861 and the corresponding union nuts are used, resulting in the same overall height.

A reliable, tight connection between welding cone and connection piece is provided by the metallic seals and additional o-rings. Such connections withstand extreme loads, including pressure impacts, vibrations and fluctuations in temperature.

Attention!

Due to the high temperatures used, the welding cone must be welded to the pipe before the o-ring is inserted.

5.0 Dichtkegelverschraubungen

Aufgrund des verwendeten Anschlusskegels (24°) ist eine normgerechte Verschraubung mit Stutzen (Bohrungsform W nach DIN 3861) durchführbar. Durch den zusätzlich im Kegel eingelegten O-Ring kommt eine metallisch/elastomere Abdichtung zustande, die eine hohe Leckagesicherheit gewährleistet.

Auch bei hohen Beanspruchungen besteht eine Unempfindlichkeit bei Druckstößen und Schwingungen. Die Baumaße entsprechen den Verschraubungen nach DIN EN ISO 8434-1. Rohranschlussseitig können wahlweise Schneidring-, Bördel- oder Schweißkegelanschlüsse montiert werden.

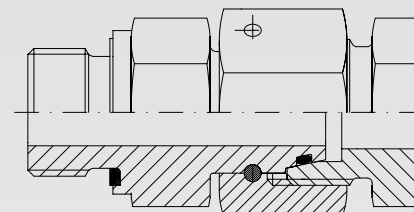

5.0 Cone Sealing Couplings 24° Cone and O-ring

Due to the connecting cone (24°) used, a standardized screwed connection using connection pieces (bore hole shape W according to DIN 3861) is possible. The o-ring additionally inserted in the cone results in a metallic / elastomer seal which provides excellent protection against leakage.

This connection is resistant to pressure impacts and vibrations even under high loads. The dimensions are identical to screwed connections according to DIN EN ISO 8434-1. Either cutting ring, edged or welding cone screw connections are possible for pipe connection.

6.0 Anwendungskriterien

Um die richtige Auswahl einer geeigneten Rohrverschraubung zu treffen, sollte der Anwender grundlegende Kriterien berücksichtigen. Vom gegebenen Sachverhalt ausgehend sind zielgerichtet Anforderung und Erwartung an das Verschraubungssystem zu knüpfen, wobei die max. zu erwartende Sicherheit Vorzug genießen sollte.

Insbesondere sind zu beachten die:

- Max. Druckbelastbarkeit (unter Berücksichtigung temperaturbezogener Druckabschläge)
- Temperaturempfindlichkeit der Dichtungswerkstoffe (die Resistenz liegt z.B. bei FPM zwischen -20°C bis +200°C)
- Baumaße
- Lebensdauer, auch bei Wiederholmontagen
- Austauschmöglichkeiten zwischen verschiedenen Rohrverschraubungsarten

7.0 Normung

Das Standardprogramm der PH-Verschraubungen entspricht der DIN 2353 / DIN EN ISO 8434-1.

Schneidringverschraubungen:

- Werden im Normalfall mit Zweikanten-Schneidring geliefert.

Bördelverschraubungen:

- SAE J 514 / ISO 8434-2 auf Anfrage mit zusätzlichem O-Ring am 37°-Konus des Kegelringes.

Schweiß- und Dichtkegelverschraubungen:

- DIN 3865, DIN EN ISO 8434-1

Überwurfmutter für Schweißkegelverschraubungen:

- DIN EN ISO 8434-1

Rohranschlussseiten:

- DIN 3861 und ISO 8434-1

Metrische- und Rohr-Gewinde:

- DIN 3852, Teil 1 und 2

NPT-Gewinde:

- ANSI / ASME B1.20.1-1983

UNF-/UN-Gewinde:

- SAE J 514

Werkstoff der Bauteile gemäß DIN 3859-1:

- X6CrNiMoTi gem. DIN 17440 Werkstoff-Nr. 1.4571 + X2CrNiMo - 1.4404

Dichtungsringe:

- FPM (z.B. Viton®), PTFE (z.B. Teflon®), NBR (Perbunan®) - andere auf Anfrage

6.0 Criteria for Use

In order to choose the best suited screwed pipe connection, a few basic criteria must be taken into consideration. Depending on the given circumstances, specific requirements and expectations must be defined which the screwed connection must fulfil. In the selection of screwed connection types, maximum possible safety should be given priority.

The following criteria must be given special attention:

- Max. resistance to pressure loads (in reference to temperature-dependent pressure reductions)
- Temperature sensitivity of material (the tolerance of, for example, FPM lies between -20°C and +200°C)
- Dimensions
- Service life, also in case of repeated assembly
- Option of exchanging screwed pipe connection types

7.0 Standardization

The standard PH pipe connection program is in compliance with DIN 2353 / DIN EN ISO 8434-1.

Cutting Ring Connections:

- Normally delivered with double-edge ring.

Flare Couplings:

- SAE J 514 / ISO 8434-2 on request with additional o-ring on the 37° taper of the tapered ring.

Welding Cone and Cone Sealing Couplings:

- DIN 3865, DIN EN ISO 8434-1

Union Nuts for Welding Cone Couplings:

- DIN EN ISO 8434-1

Pipe Connection Sides:

- DIN 3861 and ISO 8434-1

Metric and Pipe Screw Threads:

- DIN 3852, Sections 1 and 2

NPT-Threads:

- ANSI / ASME B1.20.1-1983

UNF-/UN-Threads:

- SAE J 514

Material to Components acc. to DIN 3859-1:

- X6CrNiMoTi acc. to DIN 17440 material no. 1.4571 (AISI 316 Ti) + X2CrNiMo - 1.4404 (AISI 316 L)

Sealing Rings:

- FPM (e.g. Viton®), PTFE (e.g. Teflon®), NBR (Perbunan®) - other on request

8.0 Druck- und Temperatur-Belastbarkeit

Druckbelastbarkeit

Definition der im Katalog angegebenen Drücke:

- a) Nenndruck PN
Der Nenndruck ist eine gebräuchliche, gerundete, auf den Druck bezogene Kennzahl.
- b) Betriebsdruck PB
Der zulässige Betriebsüberdruck für ein Bauteil ist der höchste Innenüberdruck, der für dieses Bauteil aufgrund des Werkstoffes und der Berechnungsgrundlagen bei der zulässigen Betriebstemperatur TB bei störungsfreiem Betrieb zulässig ist.

Zulässige Betriebstemperaturen TB

Nichtrostender Stahl: -60°C bis +400°C
1.4571 (DIN 17 440, AD W 10)

Die Angaben im Absatz „Druckabschläge“ sind hierbei zu beachten.

Bei Dichtungswerkstoffen

NBR (z.B. Perbunan®) -35°C bis +100°C
FPM (z.B. Viton®) -20°C bis +200°C
PTFE (z.B. Teflon®) -60°C bis +200°C
POM (z.B. Delrin®) -40°C bis + 80°C
(Nur bei Kugelhähnen)

Perbunan = eingetragenes Warenzeichen der Fa. Bayer.
Viton®, Teflon® und Delrin® = eingetragene Warenzeichen der Fa. Du Pont.

Die angegebenen Temperaturgrenzen für Dichtungswerkstoffe sind Richtwerte, da die Temperaturgrenzen vom Medium stark beeinflusst werden können.

Druckabschläge

Werkstoffbedingt erforderliche Druckabschläge gegenüber den Katalogangaben bei erhöhten oder tiefen Temperaturen.

Weichen die verwendeten Rohrwerkstoffe von denen der Verschraubungen ab, sind die Rohre hinsichtlich des zulässigen Temperaturbereiches und der evtl. erforderlichen Druckabschläge getrennt zu überprüfen.

Bei Verschraubungskomponenten mit Einschraubzapfen können zusätzliche Druckabschläge erforderlich sein, da der Gegenwerkstoff des Aggregates, in das die Teile eingeschraubt werden und das Dichtsystem berücksichtigt werden müssen. Bei voller Ausnutzung des Nenn- bzw. Betriebsdruckes werden Einschraubverschraubungen mit Abdichtung durch Weichdichtung empfohlen. Bei Verwendung von Einschraubverschraubungen mit Dichtkante können zusätzliche Dichtmittel erforderlich sein.

Verschraubungswerkstoffe Fitting Material	Temperaturbereich Temperature Range	Druckabschlag Pressure Reductions
1.4571	-60°C to +20°C	-
1.4571	+50°C	5%
1.4571	+100°C	11%
1.4571	+200°C	20%
1.4571	+300°C	29%
1.4571	+400°C	33%

Zwischenwerte sind zu interpolieren / Intermediate values are to be interpolated

If the tube material used deviates from the fitting material, the tube is to be checked separately with regard to the permissible temperature range and the possible pressure reductions required. Male stud fittings may require additional pressure, due to the mating part material and the sealing system must also be taken into account. For male stud fittings with cutting lace, additional sealants may be required.

8.0 Pressure and Temperature Load Capability

Pressure Load Capability

Definition of pressures specified in the catalog:

- a) Nominal Pressure PN
The nominal pressure as referred.
- b) Working Pressure PB
The permissible working pressure for a component is based on the material and the operation temperature (TB) during trouble free operation.

Permissible Operating Temperature (TB)

Stainless Steel: -60°C to +400°C
1.4571 (DIN 17 440, AD W 10)

The specifications in the „Pressure Reductions“ section are to be observed here.

For Sealing Materials:

NBR (e.g. Perbunan®) -35°C to +100°C
FPM (e.g. Viton®) -20°C to +200°C
PTFE (e.g. Teflon®) -60°C to +200°C
POM (e.g. Delrin®) -40°C to + 80°C
(Only with ball valves KH)

Perbunan = registered trademark of Bayer.
Viton®, Teflon® and Delrin® = registered trademarks of DuPont.

The temperature limits specified for sealing materials are approximate values, since the temperature limits can be greatly influenced by the medium.

Pressure Reductions

Required pressure (determined by the medium) compared with the catalog specifications for higher temperatures.

Die katalogmäßigen Nenndrücke (PN) und Betriebsdrücke (PB) stellen die max. zulässigen Betriebsdrücke einschließlich Druckspitzen dar, wobei die in den vorstehenden Tabellen aufgeführten Temperaturgrenzen und Druckabschläge berücksichtigt werden müssen.

Funktionssicherheiten bei ruhender Belastung:

Typen mit PN Angabe: 4-fach

Typen mit PB Angabe: komplette Verschraubung min. 2,5-fach
Rohranschluss 4-fach

(Wenn nicht anders angegeben).

Die Druck- und Sicherheitsangaben setzen voraus, dass die Montagen gemäß den Montagevorschriften durchgeführt wurden.

Es wird ferner vorausgesetzt, dass die Rohrleitungssysteme so verlegt und gehalten werden, dass keine zusätzlichen Beanspruchungen, Belastungen und Spannungen auf die Verschraubungen einwirken. Rohrhalterungen sind den Betriebsverhältnissen entsprechend genügend stabil auszulegen und mit Festpunkten zu verbinden.

9.0 Montageanleitung gemäß DIN 3859-2

Um einwandfreie Rohrverbindungen zu erhalten, sind bei der Montage aller Verschraubungssysteme grundlegende Voraussetzungen zu erfüllen. Unsachgemäße Montage kann zu Funktionsstörungen führen und beeinträchtigt die Sicherheit. Eine Auswahl geeigneter Rohrqualitäten finden Sie in Kapitel 16.

9.1 Rohrvorbereitung

1. Rohre rechtwinklig absägen. Winkelabweichung bis 1/2° zur Rohrachse ist zulässig. Keine Rohrabschneider verwenden!
2. Rohr an den Schnittkanten innen und außen leicht entgraten. Fase bis 0,2 x 45° ist zulässig. Späne und Schmutz entfernen.

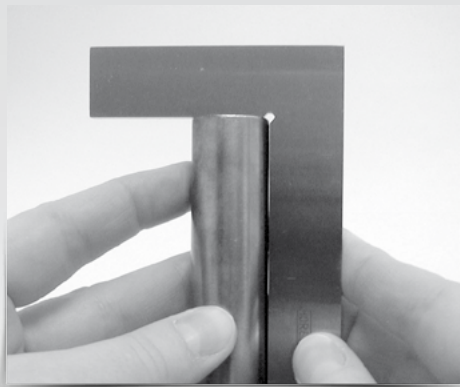

The catalog nominal pressures PN and operating pressures (PB) represent the max. permissible operating pressure peaks, in which the temperature limits and pressure reductions listed in the above tables must be taken into account.

Operational Safety at Static Load:

Types with PN Specification: 4x

*Types with PB Specification: complete fitting min. 2,5 x
tube connection 4 x*

(If not otherwise specified).

These pressure and safety specifications are based on all assemblies being in accordance to PH instructions.

It is further assumed that the tube routing will be laid and clamped in such a fashion that no additional stress, load or tension may act on the fittings. Tube fixtures are to be laid with sufficient stability according to the operating conditions and connected with supports.

9.0 Assembly Instructions according to DIN 3859-2

In order to ensure proper screwed pipe connections, several basic prerequisites must be met in the assembly of all screw connection systems. Improper assembly may lead to malfunctions and impair safety. A selection of appropriate pipe grades can be found in chapter 16.

9.1 Preparation of Pipes

1. Saw off pipe at a right angle. Deviation of angle pipe axis of up to 1/2° is permissible. Do not use a pipe cutter!
2. Lightly deburr pipe in the inside and outside of the cut edges. Bevel angles of up to 0,2 x 45° is permissible. Remove chips and particles.

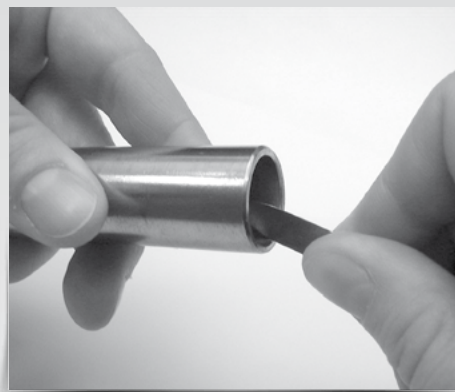

3. For pipe bends, the minimum height from the straight pipe end to the bending radius must be noted. This must be at least twice the height of the union nut.

3. Bei Rohrbögen ist die Mindesthöhe des geraden Rohrendes bis Biegeradius zu beachten. Sie muss mind. der 2-fachen Höhe der Überwurfmutter entsprechen.

9.2 Montage Schneidringverschraubung

Rohre aus nichtrostenden Stählen sind in gehärteten Vormontagegestützen oder entsprechenden Vorrichtungen vorzumontieren. Dies ist auch für Serienmontagen mit Bauteilen aus anderen Werkstoffen empfehlenswert.

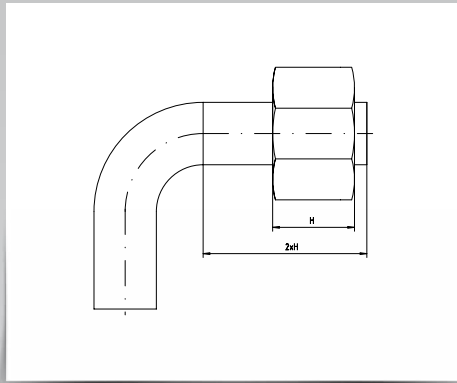

9.2 Assembly of Cutting Ring Screw Connection

Pipes of rustproof steel must be pre-assembled in hardened pre-assembly connection pieces or the corresponding devices. This can also be recommended for serial assembly using components of other materials.

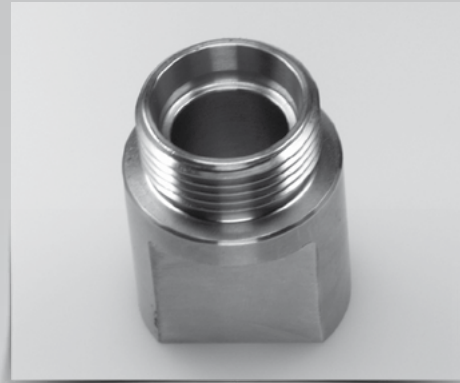

9.3 Montage mit gehärteten Vormontagegestützen

1. Gewinde der Überwurfmutter, Gewinde und Konus des Vormontagegestützen und Schneidring leicht einfetten, z.B. mit Gleitmittel „Gleitmo 810“ oder Weicon High-Tech-Paste „ASW 040P“.
2. Überwurfmutter und Schneidring auf das Rohr schieben. Stellen Sie sicher, daß der Schneidring richtig in Position gebracht ist (siehe unten)

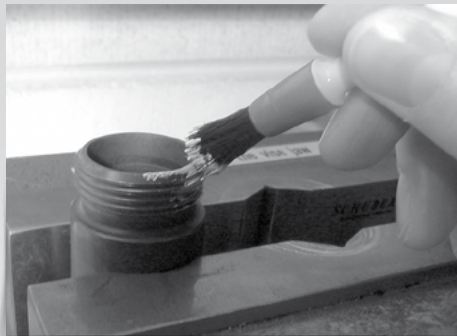

9.3 Assembly with Hardened Pre-Assembly Connection Pieces

1. Lightly grease the threads of the union nut, thread and cone of the pre-assembly connection piece and cutting ring, using, for example anti seize agent „Gleitmo 810“ or Weicon High-Tech-Paste „ASW 040P“.
2. Slide union nut and cutting ring onto the pipe. Ensure that the cutting ring is positioned correctly (see drawing below).

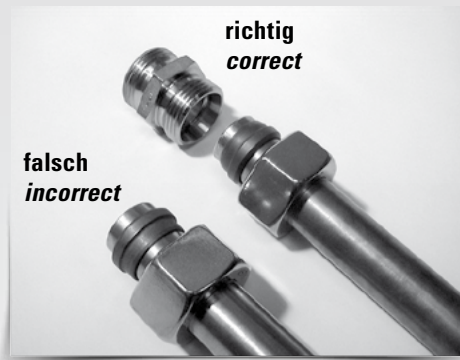

3. Überwurfmutter so weit als möglich von Hand auf den Vormontagegestützen schrauben. Gleichzeitig das Rohr gegen den Anschlag drücken. Sobald der Schneidring das Rohr erfasst hat, wird ein

3. Screw the union nut onto the pre-assembly connection piece as far as possible by hand. At the same time, press the pipe against the stop. As soon as the cutting ring has cut into the pipe, the

deutlicher Drehmomentanstieg spürbar. Ein Markierungszeichen an der Überwurfmutter erleichtert die Beobachtung der erforderlichen Umdrehungen. Überwurfmutter mit Schlüssel ca. 1 1/4 Umdrehung anziehen. Achtung: Das Rohr darf nicht mitdrehen!

4. Überprüfen, ob sich am Rohr vor der (ersten) Schneidkante ein sichtbarer Bund aufgeworfen hat.

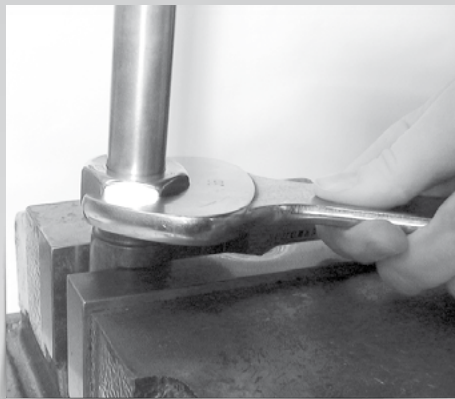

9.4 Fertigmontage im Verschraubungsstutzen

Vormontiertes Rohr in den Verschraubungsstutzen einsetzen. Mutter um ca. 1/2 Umdrehung über den spürbaren Punkt des Kraftanstiegs nachziehen und dabei den Verschraubungsstutzen mit Schlüssel gehalten.



tightening moment will increase noticeably. A flag at the union nut facilitates the observation of the necessary revolutions. Tighten union nut using a wrench by approx. 1 1/4 revolution. Important: Do not turn the pipe with the nut!

4. Check whether a visible collar has formed on the pipe in front of the (first) cutting edge.

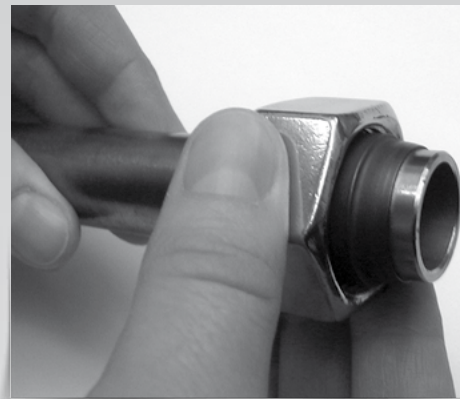

9.4 Final Assembly in Screwed Connection Piece

Insert the pre-assembled pipe into the screwed connection piece. Tighten union nut approx. 1/2 revolution beyond the point at which the tightening moment increases noticeably, holding the screwed connection piece with a wrench.

**10.0 Montageanleitung - Bördelanschlüsse /
Adapter 37° - DIN EN ISO 8434-2 / SAE J 514**

**10.0 Assembly Instructions - Flare Couplings /
Adaptors 37° - DIN EN ISO 8424-2 / SAE J 514**

10.1 Rohrauswahl

10.1 Tube Selection

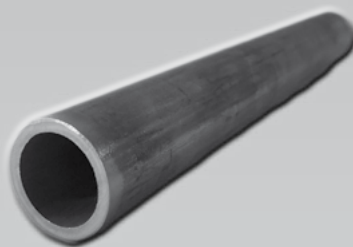

Edelstahl-Rohr	Stainless Steel tube
nahtlos kaltgezogen	cold drawn seamless
NF A 49241	NF A 49341
DIN 17458 DA/T3	DIN 17458 DA/T3
ASTM A 269	ASTM A 269

10.2 Tabelle Rohrvorbereitung

10.2 Tube Preparation Chart

Metrisches Rohr (mm) Metric tube (mm)		Zoll Rohr (inch) Inch tube (inch)		Extralänge Extra length ~ L (mm)	Gerade Mindestlänge bis zur Biegung L1 (mm) Minimum straight length to start to bend L1 (mm)	Bördel Ø Flare Ø Ø D (mm)
Rohr Ø Tube Ø	Wandstärke Wall thickness	Rohr Ø Tube Ø	Wandstärke Wall thickness			
6	1,0 - 1,5	1/4"	0,020 - 0,065	2	40	8,6 - 9,7
8	1,0 - 1,5	5/16"	0,020 - 0,065	2	40	10,2 - 11,3
10	1,0 - 1,5	3/8"	0,020 - 0,065	2	42	11,7 - 12,7
12	1,0 - 2,5	1/2"	0,028 - 0,083	2,5	43	16,0 - 17,3
14	1,5 - 2,0			2,5	52	19,3 - 20,2
15	1,0 - 2,5			2,5	52	19,3 - 20,2
16	1,5 - 2,5	5/8"	0,035 - 0,095	2,5	52	19,3 - 20,2
18	1,5 - 3,0			3	56	23,4 - 24,7
20	2,0 - 3,0	3/4"	0,035 - 0,109	3	57	23,4 - 24,7
22	1,5 - 3,0			3	58	26,5 - 27,8
25	2,0 - 3,0	1"	0,035 - 0,120	3	58	29,7 - 31,0
28	1,5 - 3,0			4	65	37,6 - 38,9
30	2,0 - 3,0			4	65	37,6 - 38,9
32	2,0 - 3,0	1 1/4"	0,049 - 0,120	4	65	37,6 - 38,9
35	2,0 - 3,0			4	70	43,2 - 45,3
38	2,0 - 4,0	1 1/2"	0,049 - 0,120	4	70	43,2 - 45,3
42	2,0 - 3,0			5	80	52,0 - 54,8
50	2,0 - 3,5	2"	0,058 - 0,134	5		59,2 - 61,2

10.3

1. • Bördeldorn ist in Bördereinheit integriert
- Bördeldorn darf keinen Verschleiß, Beschädigungen und Verschmutzungen aufweisen
- Bördeldorn sauber halten

10.3

1. • Flaring pin is integrated in flaring block
- Pin must be clean and free of wear and damage
- Keep flaring pin clean



2. • Spannbacken entsprechend Rohr AD einsetzen
- Spannflächen dürfen weder Verschleiß noch Abrieb aufweisen
- Gleitflächen sauber halten und schmieren

2. • Select flaring dies according to tube O.D.
- Grip surface must be clean and free of wear
- Keep sliding surfaces clean and lubricated

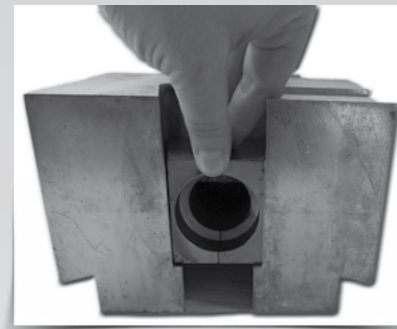
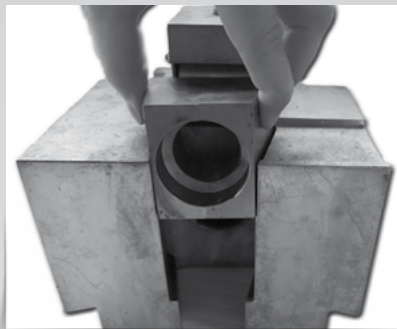

3. • Mutter und Stützhülse über das Rohrende schieben

3. • Slide nut and sleeve as shown onto the tube-end

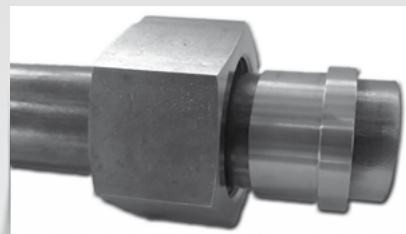

4. • Rohrende innen schmieren

4. • *Lubricate tube-end inside*



5. • Rohrende bis zum Anschlag einführen

5. • *Press tube firmly into the die against the tube stop*

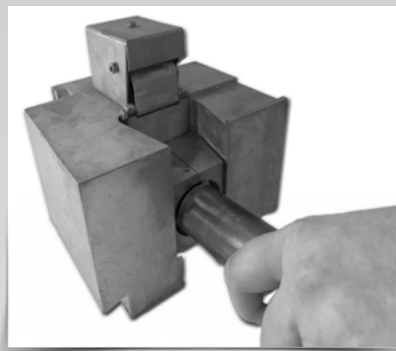

6. • Druck nach der Tabelle auf der Maschine einstellen

6. • *Adjustment according to pressure on machine*



7. • Rohr festhalten
- START-Taste betätigen und gedrückt halten
 - Nicht in den Arbeitsbereich greifen
 - Max. Druck von 400 bar nicht überschreiten

7. • *Hold tube firmly*
- *Press and hold START button*
 - *Keep hands clear off the working area*
 - *Do not exceed max. pressure 400 bar*



- 8. • Rohrende mit Spannbacken aus der Maschine entnehmen
- Backen im Separator durch Seitwärtsbewegung des Rohres lösen

- 8. • Remove tube from machine
- Use die separator for free tube

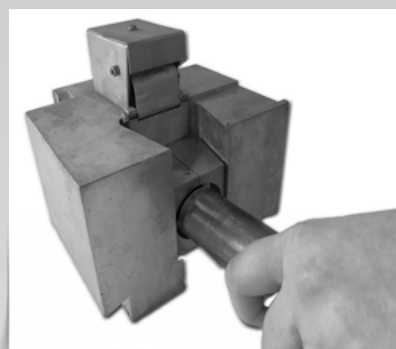

10.4 Kontrolle Bördelflansch

10.4 Checking the Flare

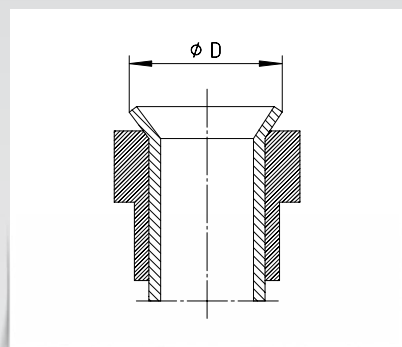

Rohr A.D. Tube O.D.		ϕD	
mm	inch	Min.	Max.
6	1/4"	8,6	9,7
8	5/16"	10,2	10,3
10	3/8"	11,7	12,7
12	1/2"	16,0	17,3
14		19,3	20,2
15		19,3	20,2
16	5/8"	19,3	20,2
18		23,4	24,7
20	3/4"	23,4	24,7
22	7/8"	26,5	27,8
25	1"	29,7	31,0
28		37,6	38,9
30		37,6	38,9
32	1 1/4"	37,6	38,9
35		43,2	45,3
38	1 1/2"	43,2	45,3
42		52,0	54,8

10.5 Installation

- Gewindeschmierung erforderlich
• Hochleistungsschmierstoff verwenden



10.5 Installation

- *Lubrication required*
• *Use high-performance lubricant*

- Mutter auf den Körper schrauben
• Mutter von Hand bis zur fühlbaren Anlage aufschrauben
• Position der Mutter markieren
• Mutter entsprechend der Tabelle festziehen

- *Thread nut onto body*
• *Tighten to full metal contact (finger tight)*
• *Mark body and nut as quality check*
• *Tighten with spanner the number of flats indicated*



- Ab RAD 28 Schlüsselverlängerung verwenden

- *Use spanner extension for larger fittings (28 mm)*



4. • Eine Schlüssel­fläche entspricht 60° Anzugswinkel

4. • 1 flat = 60°

Metrisches Rohr Metric tube	Zoll Rohr Inch Tube	SAE Gewinde SAE Thread	α Schlüssel­flächen von Fingerfest* α Flats from finger tight method*		Drehmoment Assembly torque
			Rohr Tube	Dichtkegel Swivel nut	
mm	inch				Nm - 0% + 10 %
6	1/4"	7/16"-20	2"	2"	30
8	5/16"	1/2"-20	2"	2"	40
10	3/8"	9/16"-18	1 1/2"	1 1/4"	60
12	1/2"	3/4"-16	1 1/2"	1"	115
14		7/8"-14	1 1/2"	1"	145
15		7/8"-14	1 1/2"	1"	145
16	5/8"	7/8"-14	1 1/2"	1"	145
18		1 1/16"-12	1 1/4"	1"	180
20	3/4"	1 1/16"-12	1 1/4"	1"	180
22	7/8"	1 3/16"-12	1"	1"	225
25	1"	1 5/16"-12	1"	1"	255
28		1 5/8"-12	1"		295
30		1 5/8"-12	1"	1"	295
32	1 1/4"	1 5/8"-12	1"	1"	295
35		1 7/8"-12	1"		345
38	1 1/2"	1 7/8"-12	1"	1"	345
42		2 1/4"-12	1"	1"	400

* Schlüssel­flächen von Fingerfest-Methode
* Flats from finger tight method

11.0 Montageanleitung - Verstärkungshülsen (VSHü)

11.0 Assembly instruction - Reinforcing Rings (VSHü)

1. Rohr rechtwinklig absägen. Eine Winkel­toleranz von ± 1° ist zulässig. Keine Rohrabschneider und keine Trennschleifer verwenden.

1. Saw tube off at right angles. An angle tolerance of ± 1° is permissible. Do not use a rotary grinder or tube cutter.

2. Rohrenden innen und außen leicht entgraten. Rohrleitung reinigen.

2. Slightly deburr tube ends inside and outside. Clean the tube.



Achtung!

Schief abgesägte oder falsch entgratete Rohre reduzieren die Lebensdauer und die Dichtheit der Verbindung.

Attention!

If tubes are not cut off squarely or are not properly deburred, this may reduce the service life and leaktightness of the couplings.

3. Montage von PH Verstärkungshülsen

3. Assembly of PH reinforcing rings

3.1 Hülse außen am Umfang leicht mit Montagepaste (wie z.B. Gleitmo 810 oder High Tech Paste ASW 040 P; siehe Kapitel 12) versehen. Anschließend die Hülse bis zum Rändel­hals in das Rohr einstecken.

3.1 Lubricate the outside surface the sleeve lightly using assembly paste (e.g. Gleitmo 810 or High Tech Paste ASW 040 P; see category 12). Then insert the sleeve into the tube up to the knurled section.

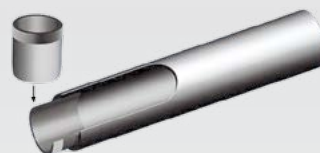

3.2 Mit einem Hammer (Kunststoff oder Hartgummi) die Hülse ganz einschlagen. Hierbei wird der Rändel­hals in die Innenwand des Rohres gepresst und sichert die Hülse gegen Verschieben oder Herausfallen.

3.2 Use a hammer (plastic or hard rubber) to drive the sleeve in totally. In doing so, the knurled section is pressed against the inner wall of the tube and prevents the sleeve from being displaced or falling out.



Hülse eingeschlagen
Sleeve driven in firmly

3.3 Bei mit • gekennzeichneten Wandstärken ist eine Verstärkungshülse erforderlich.

3.3 At wall thickness with remarks • a use of reinforcing ring is necessary.

Serie Series	Rohr A.D. Tube O.D. mm	Wandstärke Wall thickness mm						
		0,5	0,75	1	1,5	2	2,5	3
L	6	•	•					
L	8	•	•					
L	10	•	•					
L	12	•	•	•				
L	15	•	•	•				
L	18	•	•	•	•			
L	22	•	•	•	•	•		
L	28	•	•	•	•	•		
L	35	•	•	•	•	•	•	
L	42	•	•	•	•	•	•	•
S	6	•	•					
S	8	•	•					
S	10	•	•					
S	12	•	•	•				
S	14	•	•	•				
S	16	•	•	•	•			
S	20	•	•	•	•	•		
S	25	•	•	•	•	•		
S	30	•	•	•	•	•	•	
S	38	•	•	•	•	•	•	•

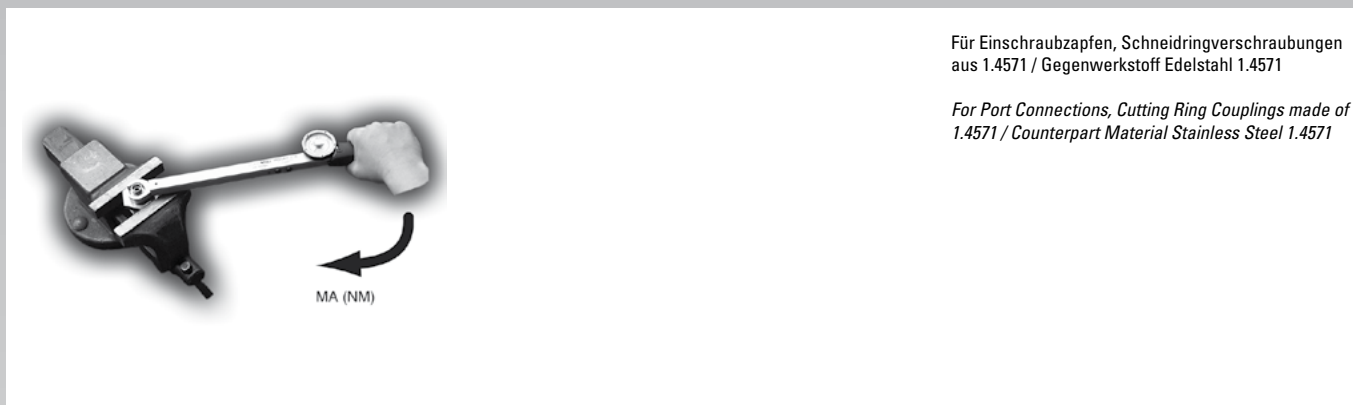

Für Einschraubzapfen, Schneidringverschraubungen aus 1.4571 / Gegenwerkstoff Edelstahl 1.4571

For Port Connections, Cutting Ring Couplings made of 1.4571 / Counterpart Material Stainless Steel 1.4571

Reihe Series	Rohr A.D. Tube O.D.	Einschraubgewinde Rohrgewinde Male Stud Thread BSPP Thread	MA (Nm)	Einschraubgewinde Metrisches ISO-Gewinde Male Stud Thread Metric ISO-Thread	MA (Nm)
L	6	G 1/8" A	30	M 10 x 1	30
L	8	G 1/4" A	60	M 12 x 1,5	35
L	10	G 1/4" A	60	M 14 x 1,5	60
L	12	G 3/8" A	95	M 16 x 1,5	95
L	15	G 1/2" A	190	M 18 x 1,5	110
L	18	G 1/2" A	130	M 22 x 1,5	190
L	22	G 3/4" A	265	M 26 x 1,5	340
L	28	G 1" A	445	M 33 x 2	510
L	35	G 1 1/4" A	720	M 42 x 2	720
L	42	G 1 1/2" A	960	M 48 x 2	960

Reihe Series	Rohr A.D. Tube O.D.	Einschraubgewinde Rohrgewinde Male Stud Thread BSPP Thread	MA (Nm)	Einschraubgewinde Metrisches ISO-Gewinde Male Stud Thread Metric ISO-Thread	MA (Nm)
S	6	G 1/4" A	75	M 12 x 1,5	45
S	8	G 1/4" A	75	M 14 x 1,5	75
S	10	G 3/8" A	135	M 16 x 1,5	115
S	12	G 3/8" A	135	M 18 x 1,5	145
S	14	G 1/2" A	205	M 20 x 1,5	205
S	16	G 1/2" A	170	M 22 x 1,5	230
S	20	G 3/4" A	385	M 27 x 2	385
S	25	G 1" A	460	M 33 x 2	600
S	30	G 1 1/4" A	720	M 42 x 2	720
S	38	G 1 1/2" A	960	M 48 x 2	960

Toleranz der in o.g. Tabelle aufgeführten Anziehdrehmomente = + 10 %.

Wichtiger Hinweis: Einschraubzapfen vor dem Einschrauben mit geeigneten Mitteln einschmieren.

Die angegebenen Werte gelten für zylindrische Einschraubverschraubungen aus Edelstahl 1.4571, der Gegenkörper mit dem Einschraubloch ebenfalls aus Edelstahl 1.4571.

Die Werte gelten nicht für Schwenkverschraubungen WHV / THV. Die Werte gelten ebenfalls nicht für kegelige sowie NPT Einschraubgewinde. Für Adapter Katalog Teil 5 und Gewinde-Reduzierungen Teil 8 (Typ GRI) sind die Anziehdrehmomente der Reihe S zu verwenden.

Tolerance in above mentioned table of specified torque data = + 10 %.

Important: Male stud thread has to be greased with recommended lubrication before screwing in.

The mentioned data are only valid for parallel male stud couplings made of material 1.4571 (AISI 316 Ti), the counterpart with port made of material 1.4571 (AISI 316 Ti), too.

The data are not valid for banjo couplings WHV / THV, also not for taper and NPT male threads. For adaptors (catalog part 5) and reducing stud adaptors (catalog part 8, type GRI) the specified torque data of the S-Series have to be used.

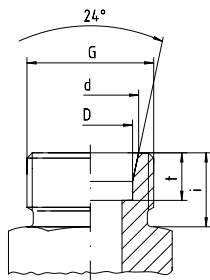

Schneidringanschluss
Bohrungsform W DIN 3861 + DIN EN ISO 8434-1

Cutting Ring Connection
Type of Port End W DIN 3861 + DIN EN ISO 8434-1

Reihe Series	Rohr A.D. Tube O.D. D	Gewinde Thread G	d	i	t
LL	4	M 8 x 1	5,0	8	4,0
LL	6	M 10 x 1	7,5	8	5,5
LL	8	M 12 x 1	9,5	9	5,5

Reihe Series	Rohr A.D. Tube O.D. D	Gewinde Thread G	d	i	t
L	6	M 12 x 1,5	8,1	10	7,0
L	8	M 14 x 1,5	10,1	10	7,0
L	10	M 16 x 1,5	12,3	11	7,0
L	12	M 18 x 1,5	14,3	11	7,0
L	15	M 22 x 1,5	17,3	12	7,0
L	18	M 26 x 1,5	20,3	12	7,5
L	22	M 30 x 2	24,3	14	7,5
L	28	M 36 x 2	30,3	14	7,5
L	35	M 45 x 2	38,0	16	10,5
L	42	M 52 x 2	45,0	16	11,0

Reihe Series	Rohr A.D. Tube O.D. D	Gewinde Thread G	d	i	t
S	6	M 14 x 1,5	8,1	12	7,0
S	8	M 16 x 1,5	10,1	12	7,0
S	10	M 18 x 1,5	12,3	12	7,5
S	12	M 20 x 1,5	14,3	12	7,5
S	14	M 22 x 1,5	16,3	14	8,0
S	16	M 24 x 1,5	18,3	14	8,5
S	20	M 30 x 2	22,9	16	10,5
S	25	M 36 x 2	27,9	18	12,0
S	30	M 42 x 2	33,0	20	13,5
S	38	M 52 x 2	41,0	22	16,0

1.

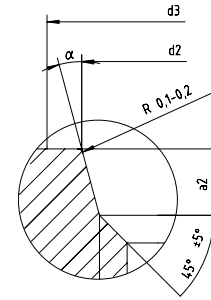
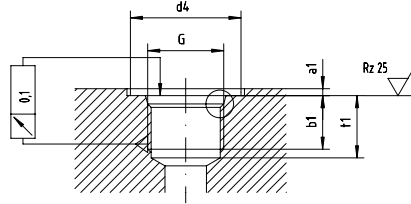
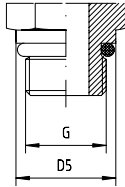

Einschraubzapfen Form F mit O-Ring-Dichtung
(DIN ISO 6149 - 2+3)

Einschraubzapfen UST mit O-Ring-Dichtung (SAE J 514)

Screwed Plug Form F with O-ring-Sealing (DIN ISO 6149 - 2+3)
Screwed Plug UST with O-ring-Sealing (SAE J 514)

Einschraubloch für O-Ring-Dichtung (SAE J 514)

Screw Hole with O-ring-Sealing (SAE J 514)

Einschraubloch Form W (DIN 3852, Teil 3 / ISO 6149)

Screw Hole Form W (DIN 3852, Part 3 / ISO 6149)

1. Für Rohrverschraubungen

Metrisches ISO-Gewinde - DIN 3852 bzw. ISO 6149
UNF / UN-Gewinde - SAE J 514

For Screwed Pipe Connections
Metric ISO-Thread - DIN 3852 resp. ISO 6149
UNF / UN-Thread - SAE J 514

G	D5	d4 min.	d3	d2 ± 0,1	a1 max.	a2	t1 min.	b1 min.	α ± 1°
M 8 x 1	10,9	17	11	9,10	1,0	1,6	11,5	10,0	12°
M 10 x 1	12,9	20	13	11,10	1,0	1,6	11,5	10,0	12°
M 12 x 1,5	16,9	22	16	13,80	1,5	2,4	14,0	11,5	15°
M 14 x 1,5	18,9	25	18	15,80	1,5	2,4	14,0	11,5	15°
M 16 x 1,5	20,9	27	20	17,80	1,5	2,4	15,5	13,0	15°
M 18 x 1,5	22,9	29	22	19,80	2,0	2,4	16,5	14,5	15°
M 20 x 1,5	24,9	32	24	21,80	2,0	2,4	16,5	14,0	15°
M 22 x 1,5	26,9	34	26	23,80	2,0	2,4	18,0	15,5	15°
M 26 x 1,5	30,9	37	31	29,05	2,0	3,1	18,5	16,0	15°
M 27 x 2	31,9	40	32	29,40	2,0	3,1	22,0	19,0	15°
M 33 x 2	37,9	46	38	35,40	2,5	3,1	22,0	19,0	15°
M 42 x 2	47,9	56	47	44,40	2,5	3,1	22,5	19,5	15°
M 48 x 2	54,9	64	53	50,40	2,5	3,1	25,0	22,0	15°
7/16"-20 UNF	14,4	21	15	12,40	1,6	2,4	14,0	11,5	12°
9/16"-18 UNF	17,6	25	18	15,60	1,6	2,5	15,5	12,7	12°
3/4"-16 UNF	22,3	30	23	20,60	2,4	2,5	17,5	14,3	15°
7/8"-14 UNF	25,5	34	26	23,90	2,4	2,5	20,0	16,7	15°
11/16"-12 UN	31,9	41	32	29,20	2,4	3,3	23,0	19,0	15°
15/16"-12 UN	38,2	49	39	35,50	3,2	3,3	23,0	19,0	15°
15/8"-12 UN	47,7	58	48	43,50	3,2	3,3	23,0	19,0	15°

2.

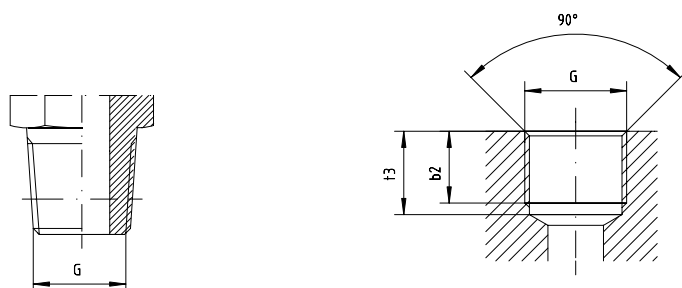

Einschraubzapfen NPT
ANSI / ASME B1.20.1-1983

Screwed Plug NPT
ANSI / ASME B1.20.1-1983

Einschraubloch NPT
ANSI / ASME B1.20.1-1983

Screw Hole NPT
ANSI / ASME B1.20.1-1983

2. NPT-Gewinde - ANSI / ASME B1.20.1-1983

NPT-Thread - ANSI / ASME B1.20.1-1983

G	t3 min.	b2 min.
1/8"-27,0 NPT	11,6	6,9
1/4"-18,0 NPT	16,4	10,0
3/8"-18,0 NPT	17,4	10,3
1/2"-14,0 NPT	22,6	13,6
3/4"-14,0 NPT	23,1	14,1
1"-11,5 NPT	27,8	16,8
1 1/4"-11,5 NPT	28,3	17,3
1 1/2"-11,5 NPT	28,3	17,3

1.

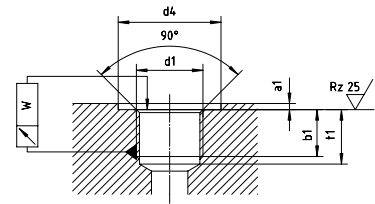
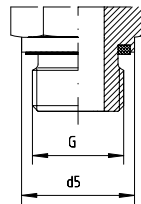
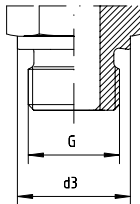

Einschraubzapfen Form B - DIN 3852, Teil 1 / Teil 2
Abdichtung durch Dichtkante

Einschraubzapfen Form E (Entwurf) - DIN 3852, Teil 1 / Teil 2
Abdichtung durch gekammerte Weichdichtung (wd)

Einschraubloch Form X nach DIN 3852, Teil 1 / Teil 2
(Für zylindrische und kegelige Einschraubgewinde)

*Screwed Plug Form B - DIN 3852, Part 1 / Part 2
Sealed by Sealing-Edge*

*Screwed Plug Form E (Design) - DIN 3852, Part 1 / Part 2
Sealed by Captive Soft-Sealing (wd)*

*Screw Hole Form X acc. to DIN 3852, Part 1 / Part 2
(For Taper and Parallel Stud Thread)*

1. Für Rohrverschraubungen
Metrisches ISO-Gewinde (Zylindrisch) DIN 13
Whitworth-Rohrgewinde (Zylindrisch) DIN / ISO 228

*For Screwed Pipe Connections
Metric ISO-Thread (Parallel) DIN 13
Whitworth-Pipe-Thread (Parallel) DIN / ISO 228*

G	d3	d4 +0,4	d5	a1 max.	b1 min.	t1 min.	W
M 8 x 1	12	13	12,0	1,0	8	13,5	0,1
M 10 x 1	14	15	14,0	1,0	8	13,5	0,1
M 12 x 1,5	17	18	17,0	1,5	12	18,5	0,1
M 14 x 1,5	19	20	19,0	1,5	12	18,5	0,1
M 16 x 1,5	21	22	21,9	1,5	12	18,5	0,1
M 18 x 1,5	23	24	23,9	2,0	12	18,5	0,1
M 20 x 1,5	25	26	25,9	2,0	14	20,5	0,1
M 22 x 1,5	27	28	27,0	2,5	14	20,5	0,1
M 26 x 1,5	31	32	31,9	2,5	16	22,5	0,2
M 27 x 2	32	33	32,0	2,5	16	24,0	0,2
M 33 x 2	39	40	39,9	2,5	18	26,0	0,2
M 42 x 2	49	50	49,9	2,5	20	28,0	0,2
M 48 x 2	55	56	55,0	2,5	22	30,0	0,2
G 1/8" A ¹	14	15	14,0	1,0	8	13,0	0,1
G 1/4" A ¹	18	19	18,9	1,5	12	18,5	0,1
G 3/8" A ¹	22	23	22,0	2,0	12	18,5	0,1
G 1/2" A ¹	26	27	26,9	2,5	14	22,0	0,1
G 3/4" A ¹	32	33	32,0	2,5	16	24,0	0,2
G 1" A ¹	39	40	39,9	2,5	18	27,0	0,2
G 1 1/4" A ¹	49	50	49,9	2,5	20	29,0	0,2
G 1 1/2" A ¹	55	56	55,0	2,5	22	31,0	0,2

¹Bei Innengewinden entfällt A!

²Dichtheit kann nur mit flüssigen oder plastischen Dichtmitteln erreicht werden!

¹With Female Thread "A" applicable!

²Sealing can only be achieved with liquid or plastic jointing-medium!

2.

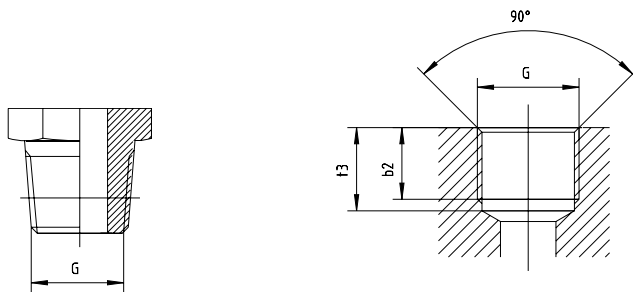

Einschraubzapfen Form C nach DIN 3852, Teil 1 / Teil 2
Abdichtung durch Kegelfgewinde

*Screwed Plug Form C acc. to DIN 3852, Part 1 / Part 2
Sealing by Taper Thread*

xxx Einschraubloch Form Z nach DIN 3852, Teil 1 / Teil 2
(Nur für kegelige Einschraubgewinde)²

*xxx Screw Hole Form Z acc. to DIN 3852, Part 1 / Part 2
(Only for Taper Stud Thread)²*

2. Metrisches kegeliges Außengewinde DIN 158
Whitworth-Rohrgewinde (Kegelig) DIN 3858

*Metric Taper Outside Thread DIN 158
Whitworth-Pipe-Thread (Taper) DIN 3858*

G	b2 min.	t3 min.
M 8 x 1 keg	5,5	10,0
M 10 x 1 keg	5,5	10,0
M 12 x 1,5 keg	8,5	13,5
M 14 x 1,5 keg	8,5	13,5
M 16 x 1,5 keg	8,5	13,5
M 18 x 1,5 keg	8,5	13,5
M 20 x 1,5 keg	10,5	15,5
M 22 x 1,5 keg	10,5	15,5
-	-	-
-	-	-
-	-	-
-	-	-
-	-	-
R 1/8" keg	5,5	9,5
R 1/4" keg	8,5	13,5
R 3/8" keg	8,5	13,5
R 1/2" keg	10,5	16,5
-	-	-
-	-	-
-	-	-
-	-	-

xxx Achtung: Zusätzliches Dichtmittel erforderlich!
xxx Attention: Additional sealing material required!



Zur jeweiligen Schlauch- und Gewindegröße

To each Hose and Thread Size

Schlüsselkennzahl Key-Code Size / Dash	Schlauchgröße Hose Size		Rohrgewinde / Zyl. + Keg. BSP-Thread / Parallel + Taper	NPT-Gewinde NPT-Thread	UNF(UN)-Gewinde UNF(UN)-Thread JIC - 37°	UNF, UN, UNS Gewinde / Thread ORFS	SAE (ISO)-Flansch SAE (ISO)-Flange 3000 / 6000 P.S.I.
	DN	in.					
02			1/8"-28	1/8"-27,0			
04	06	1/4"	1/4"-19	1/4"-18,0	7/16"-20	9/16"-18	
05	08	5/16"			1/2"-20		
06	10	3/8"	3/8"-19	3/8"-18,0	9/16"-18	11/16"-16	1/2"
08	12	1/2"	1/2"-14	1/2"-14,0	3/4"-16	13/16"-16	
10	16	5/8"	5/8"-14		7/8"-14	1"-14	
12	19	3/4"	3/4"-14	3/4"-14,0	1 1/16"-12	1. 3/16"-12	3/4"
16	25	1"	1"-11	1"-11,5	1 5/16"-12	1. 7/16"-12	1"
20	31	1 1/4"	1 1/4"-11	1 1/4"-11,5	1 5/8"-12	1. 11/16"-12	1 1/4"
24	38	1 1/2"	1 1/2"-11	1 1/2"-11,5	1 7/8"-12	2"-12	1 1/2"
32	51	2"	2"-11	2"-11,5	2 1/2"-12		2"
38	60	2 3/8"					
40							2 1/2"
48	76	3"					3"

















Adapter – BSP – Metrisch – NPT – Kegelig
Adaptors – BSP – Metric – NPT – Taper





ADAPTER - BSP - METRISCH - NPT - KEGELIG



ADAPTORS - BSP - METRIC - NPT - TAPER

Produktgruppen	Product Groups	Seite Page
 <p>Gerade Adapter - BSP - Metrisch - 60°-Konus</p>	<p>Straight Adaptors - BSP - Metric - 60°-Cone</p>	5.4
 <p>Gerade Anschweißstutzen - Metrisch - 60°-Konus</p>	<p>Straight Welding Adaptors - Metric - 60°-Cone</p>	5.5
 <p>Gerade Adapter - BSP - Zylindrisch - BSP - Kegelig - BSP - Zylindrisch - 60°-Konus - BSP - Zylindrisch - 60°-Konus mit Weichdichtung - BSP - Zylindrisch - Flachdichtend - BSP - Zylindrisch - Reduziert - 60°-Konus - BSP - Zylindrisch - Reduziert - 60°-Konus mit Weichdichtung - BSP - Zylindrisch - NPT - NPT - NPT - NPT - NPT - Reduziert - BSP - Kegelig - BSP - Kegelig - BSP - Kegelig - BSP - Kegelig - Reduziert</p>	<p>Straight Adaptors - BSP - Parallel - BSP - Taper - BSP - Parallel - 60°-Cone - BSP - Parallel - 60°-Cone with Soft Sealing - BSP - Parallel - Flat Face - BSP - Parallel - Reduced - 60°-Cone - BSP - Parallel - Reduced - 60°-Cone with Soft Sealing - BSP - Parallel - NPT - NPT - NPT - NPT - NPT - Reduced - BSP - Taper - BSP - Taper - BSP - Taper - BSP - Taper - Reduced</p>	<p>5.6 5.7 5.8 5.9 5.10 5.11 5.12 5.13 5.14 5.15 5.16</p>
 <p>Verschlussstopfen - BSP - Kegelig - NPT - Männlich</p>	<p>Plug - BSP - Taper - NPT - Male</p>	<p>5.17 5.18</p>
 <p>Gerade Adapter - BSP - Weiblich - BSP - Kegelig - BSP - Weiblich - NPT - Männlich - BSP - Weiblich - BSP - Zylindrisch</p>	<p>Straight Adaptors - BSP - Female - BSP - Taper - BSP - Female - NPT - Male - BSP - Female - BSP - Parallel</p>	<p>5.19 5.20 5.21</p>
 <p>Adapter - DKR - Gerade Adapter - BSP - Weiblich - Winkel-Adapter - BSP - Weiblich - T-Adapter - BSP - Weiblich - K-Adapter - BSP - Weiblich</p>	<p>Adaptors - DKR - Straight Adaptors - BSP - Female - Elbow-Adaptors - BSP - Female - T-Adaptors - BSP - Female - K-Adaptors - BSP - Female</p>	<p>5.22 5.23 5.24 5.25</p>
 <p>Adapter - Winkel-Adapter - BSP - Zylindrisch - Männlich - Winkel-Adapter - NPT - NPT - Männlich - 90° - T-Adapter - BSP - Zylindrisch - Männlich - K-Adapter - BSP - Zylindrisch - Männlich</p>	<p>Adaptors - Elbow-Adaptors - BSP - Male - Elbow-Adaptors - NPT - NPT - Male - 90° - T-Adaptors - BSP - Male - K-Adaptors - BSP - Male</p>	<p>5.26 5.27 5.28 5.29</p>
 <p>WE-Kompakt-Winkeladapter - 90° - BSP - Weiblich - BSP - Zylindrisch - Männlich - 45° - BSP - Weiblich - BSP - Zylindrisch - Männlich</p>	<p>WE-Block-Elbow-Adaptors - 90° - BSP - Female - BSP - Male - 45° - BSP - Female - BSP - Male</p>	<p>5.30 5.31</p>
 <p>Adapter - LE-Adapter - BSP - Weiblich - BSP - Zylindrisch - Männlich - TE-Adapter - BSP - Weiblich - BSP - Zylindrisch - Männlich</p>	<p>Adaptors - LE-Adaptors - BSP - Female - BSP - Male - TE-Adaptors - BSP - Female - BSP - Male</p>	<p>5.32 5.33</p>
 <p>Adapter - Winkel-Adapter - BSP - Zylindrisch - T-Adapter - BSP - Zylindrisch - Winkel-Adapter - NPT - T-Adapter - NPT</p>	<p>Adaptors - Elbow-Adaptors - BSP - Parallel - T-Adaptors - BSP - Parallel - Elbow-Adaptors - NPT - T-Adaptors - NPT</p>	<p>5.34 5.35 5.36 5.37</p>



Produktgruppen	Product Groups	Seite Page
 Winkel-Adapter - 90° - NPT - Männlich - NPT - Weiblich	Elbow-Adaptors - 90° - NPT - Male - NPT - Female	5.38
 Gerade Schott-Adapter - BSP - Zylindrisch - Männlich	Straight Bulkhead Adaptors - BSP - Male	5.39
 Winkel-Adapter - BSP - Zylindrisch - Männlich - BSP - Kegelig - Männlich	Elbow-Adaptors - BSP - Male - BSP - Taper - Male	5.40
 Sechskant-Muffen - BSP - Zylindrisch - BSP - Zylindrisch - Reduziert - NPT - NPT - Reduziert	Hexagon Sockets - BSP - Female - BSP - Female - Reduced - NPT - Female - NPT - Reduced	5.41 5.42 5.43 5.44
 Verschlusskappen - DKR - BSP - Weiblich	Swivel Caps - DKR - BSP - Female	5.45
 Verschlussstopfen - BSP - Zylindrisch mit Außen-Sechskant	BSP-60°-Coned Plug - Parallel with Outside Hexagon	5.46
 Sechskant-Adapter - BSP - Außen / Innen - Form A - BSP - Außen / Innen - Form B	Hexagon Adaptors - BSP - Male / Female - Form A - BSP - Male / Female - Form B	5.47 5.48
 Gewinde-Reduzierungen - BSP - Außen - NPT - Innen - Form A - BSP - Außen - NPT - Innen - Form B - NPT - Außen - BSP - Innen - Form A - NPT - Außen - BSP - Innen - Form B - NPT - Außen - NPT - Innen - Form A - NPT - Außen - NPT - Innen - Form B	Male/Female Stud Adaptors - BSP - Male - NPT - Female - Form A - BSP - Male - NPT - Female - Form B - NPT - Male - BSP - Female - Form A - NPT - Male - BSP - Female - Form B - NPT - Male - NPT - Female - Form A - NPT - Male - NPT - Female - Form B	5.49 5.50 5.51 5.52 5.53 5.54
 Sechskant-Kappen - BSP - Zylindrisch - Innen - NPT - Innen	Hexagon Caps - BSP - Parallel - Female - NPT - Female	5.55 5.56
 EVW-Verschraubungen - 90° - BSP - Männlich	Male Stud Elbows - 90° - BSP - Male	5.57



Produktgruppen	Product Groups	Seite Page
 Gegenmutter für Schottverschraubungen - Zylindrisch	<i>Locknuts for Bulkhead Couplings</i> - BSP - Parallel	5.58
 Gerade Schott-Adapter - BSP - Metrisch	<i>Straight Bulkhead Adaptors</i> - BSP - Metric	5.59

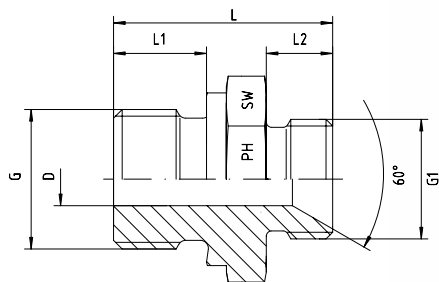

BSP mit angedrehter Dichtkante Form B
Metrisch mit 60°-Innenkonus

BSP with Sealing Shoulder Form B
Metric with 60°-Cone

Druck Pressure PN	Gewinde Thread		Ca. Maße Approx. Dimensions					Bestellzeichen Order-Code	Brutto-Preis Gross-Price Euro (€)
	G = BSP	G1	L	L1	L2	D	SW		
250	1/2"	M 18 x 1,5	34	14	11	10	27	0226820-08-06	13,50
250	1/2"	M 22 x 1,5	35	14	12	11	27	0226820-08	13,50
250	1/2"	M 26 x 1,5	38	14	12	14	27	0226820-08-10	13,50
160	1/2"	M 30 x 1,5	36	14	12	12	32	0226820-08-12	17,95
160	3/4"	M 26 x 1,5	38	16	12	15	32	0226820-12-10	17,20
160	3/4"	M 30 x 1,5	39	16	14	20	32	0226820-12	15,30
160	1"	M 30 x 1,5	41	18	14	20	41	0226821-16-12	28,30
160	1"	M 38 x 1,5	41	18	14	24	41	0226825-16	25,30
100	1 1/4"	M 38 x 1,5	44	20	14	25	50	0226826-20-16	40,50
100	1 1/4"	M 45 x 1,5	46	20	16	32	50	0226832-20	35,50
100	1 1/2"	M 45 x 1,5	49	22	16	32	55	0226833-24-20	55,50
100	1 1/2"	M 52 x 1,5	49	22	16	39	55	0226840-24	45,50
50	2"	M 65 x 2	54	24	17	45	70	0226850-32	69,70
50	2 1/2"	M 78 x 2	57	26	17	56	85	0226860-40	204,55
50	3"	M 100 x 2	68	28	22	76	105	0226880-48	450,00



Metrisch - Fein mit 60°-Innenkonus

Metric - Pitch 1,5 mm and 2 mm with 60°-Cone

Druck Pressure PN	Gewinde Thread G	Ca. Maße Approx. Dimensions					Bestellzeichen Order-Code	Brutto-Preis Gross-Price Euro (€)
		L	L1	D	D1	SW		
250	M 12 x 1,5	24	10	3,5	6	12	0806504-02	11,60
250	M 14 x 1,5	25	10	4,5	8	14	0806507-04	11,80
250	M 16 x 1,5	25	10	6,0	10	17	0806509-05	12,00
250	M 18 x 1,5	25	10	8,0	14	19	0806511-06	12,00
250	M 22 x 1,5	27	12	10,5	17	22	0806514-08	13,00
250	M 26 x 1,5	28	12	13,0	21	27	0806517-10	14,00
160	M 30 x 1,5	28	12	15,5	25	30	0806521-12	15,00
160	M 38 x 1,5	30	14	21,0	30	41	0806526-16	24,00
100	M 45 x 1,5	31	14	28,0	38	46	0806533-20	30,00
100	M 52 x 1,5	32	14	35,0	44	55	0806541-24	36,50
50	M 65 x 2	36	17	45,0	57	65	0806551-32	56,00
50	M 78 x 2	36	17	55,0	64	80	0806561-40	118,50
50	M 90 x 2	47	22	67,0	76	90	0806571-48	140,50
50	M 100 x 2	47	22	77,0	89	100	0806581-56	179,20

GERADE ADAPTER STRAIGHT ADAPTORS

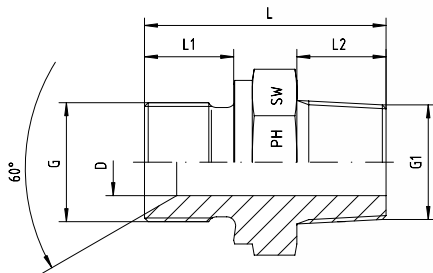

BSP - Zylindrisch - Männlich mit 60°-Konus
BSP - Kegelig - Männlich
Andere Größen auf Anfrage!

*BSP - Male with 60°-Cone
BSP - Taper - Male
Other sizes on request!*

Druck Pressure PN	Gewinde Thread		Ca. Maße Approx. Dimensions					Bestellzeichen Order-Code	Brutto-Preis Gross-Price Euro (€)
	G = BSP	G1 = BSPT	L	L1	L2	D	SW		
400	1/8"-28	1/8"-28	23,0	8	8	4,0	14	1050710-02-02	6,00
400	1/4"-19	1/4"-19	30,0	10	12	6,0	19	1050710-04-04	5,37
400	3/8"-19	3/8"-19	32,5	12	12	9,0	22	1050710-06-06	6,75
400	1/2"-14	1/2"-14	37,0	14	14	12,5	27	1050710-08-08	9,18
400	3/4"-14	3/4"-14	47,0	16	19	17,5	32	1050710-12-12	12,45
400	1"-11	1"-11	49,0	18	18	22,0	41	1050710-16-16	19,40
200	1 1/4"-11	1 1/4"-11	54,5	20	20	29,0	50	1050710-20-20	36,00
200	1 1/2"-11	1 1/2"-11	58,5	22	22	37,0	55	1050710-24-24	51,85
100	2"-11	2"-11	66,0	25	26	45,0	70	1050710-32-32	99,00

Druck Pressure PN	Gewinde Thread		Ca. Maße Approx. Dimensions					Bestellzeichen Order-Code	Brutto-Preis Gross-Price Euro (€)
	G = BSP	G1 = BSPT	L	L1	L2	D	SW		
400	1/4"-19	1/8"-28	26,0	10	8	4,0	19	1050710-04-02	6,95
400	1/4"-19	3/8"-19	32,0	10	12	7,0	19	1050710-04-06	8,45
400	1/4"-19	1/2"-14	34,0	10	14	6,0	22	1050710-04-08	10,35
400	3/8"-19	1/4"-19	33,0	12	12	7,0	22	1050710-06-04	8,45
400	3/8"-19	1/2"-14	42,0	12	19	9,0	22	1050710-06-08	10,30
400	1/2"-14	3/8"-19	37,0	14	12	9,0	27	1050710-08-06	10,30
400	1/2"-14	3/4"-14	45,0	14	19	12,5	27	1050710-08-12	15,65
400	3/4"-14	1/2"-14	40,0	16	14	12,5	32	1050710-12-08	15,95
400	3/4"-14	1"-11	45,0	16	18	17,5	36	1050710-12-16	19,50

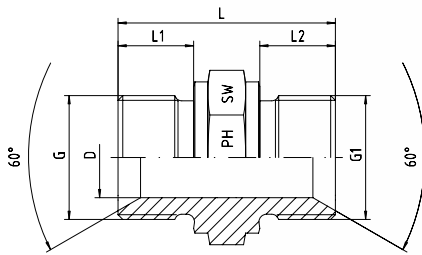

BSP - BSP
Mit 60°-Innenkonus und angedrehter Dichtkante Form B
Männlich - Männlich

BSP - BSP
With 60°-Cone and Sealing Shoulder Form B
Male - Male - Parallel

Druck Pressure PN	Gewinde Thread		Ca. Maße Approx. Dimensions					Bestellzeichen Order-Code	Brutto-Preis Gross-Price Euro (€)
	G = BSP	G1 = BSP	L	L1	L2	D	SW		
400	1/8"-28	1/8"-28	23,0	8	8	4,5	14	1050510-02-02	5,00
400	1/4"-19	1/4"-19	29,0	10	10	6,0	19	1050510-04-04	5,10
400	3/8"-19	3/8"-19	35,0	12	12	9,0	22	1050510-06-06	5,65
400	1/2"-14	1/2"-14	41,0	14	14	13,0	27	1050510-08-08	7,80
400	5/8"-14	5/8"-14	43,5	16	16	14,5	30	1050510-10-10	12,50
400	3/4"-14	3/4"-14	46,0	16	16	18,0	32	1050510-12-12	12,30
400	1"-11	1"-11	52,0	18	18	23,5	41	1050510-16-16	19,30
200	1 1/4"-11	1 1/4"-11	58,0	20	20	30,0	50	1050510-20-20	27,50
200	1 1/2"-11	1 1/2"-11	61,0	22	22	37,0	55	1050510-24-24	35,80
100	2"-11	2"-11	67,0	25	25	45,0	70	1050510-32-32	74,80
70	2 1/2"-11	2 1/2"-11	70,0	26	26	51,0	90	1050510-40-40	172,50

GERADE ADAPTER MIT WEICHDICHTUNG

STRAIGHT ADAPTORS WITH SOFT SEALING



EDELSTAHL / STAINLESS STEEL
VERBINDUNGSTECHNIK
FLUID CONNECTORS

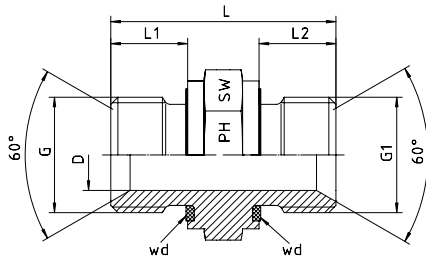

BSP - BSP

Mit 60°-Innenkonus
wd = Abdichtung durch Profildichtung - Viton
Männlich - Männlich

BSP - BSP

With 60°-Cone
wd = Sealing by an Elastomer Profiled Ring - Viton
Male - Male - Parallel

Druck Pressure PN	Gewinde Thread		Ca. Maße Approx. Dimensions					Bestellzeichen Order-Code	Brutto-Preis Gross-Price Euro (€)
	G = BSP	G1 = BSP	L	L1	L2	D	SW		
400	1/8"-28	1/8"-28	23,0	8	8	4,5	14	1050508-02-02	7,50
400	1/4"-19	1/4"-19	29,0	10	10	6,0	19	1050508-04-04	7,65
400	3/8"-19	3/8"-19	35,0	12	12	9,0	22	1050508-06-06	8,50
400	1/2"-14	1/2"-14	41,0	14	14	13,0	27	1050508-08-08	11,70
400	3/4"-14	3/4"-14	46,0	16	16	18,0	32	1050508-12-12	18,45
400	1"-11	1"-11	52,0	18	18	23,5	41	1050508-16-16	28,95
200	1 1/4"-11	1 1/4"-11	58,0	20	20	30,0	50	1050508-20-20	41,25
200	1 1/2"-11	1 1/2"-11	61,0	22	22	37,0	55	1050508-24-24	53,70
100	2"-11	2"-11	67,0	25	25	45,0	70	1050508-32-32	112,20

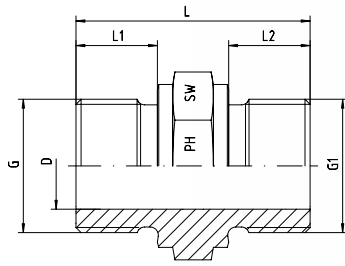

BSP - BSP - Flachdichtend
Mit angedrehter Dichtkante Form B
Männlich - Männlich

BSP - BSP - Flat face
With Sealing Shoulder Form B
Male - Male - Parallel

Druck Pressure PN	Gewinde Thread		Ca. Maße Approx. Dimensions					Bestellzeichen Order-Code	Brutto-Preis Gross-Price Euro (€)
	G = BSP	G1 = BSP	L	L1	L2	D	SW		
400	1/8"-28	1/8"-28	23,0	8	8	4,5	14	1050521-02-02	5,95
400	1/4"-19	1/4"-19	29,0	10	10	6,0	19	1050521-04-04	6,10
400	3/8"-19	3/8"-19	35,0	12	12	9,0	22	1050521-06-06	6,75
400	1/2"-14	1/2"-14	41,0	14	14	13,0	27	1050521-08-08	9,35
400	5/8"-14	5/8"-14	43,5	16	16	14,5	30	1050521-10-10	18,75
400	3/4"-14	3/4"-14	46,0	16	16	18,0	32	1050521-12-12	14,75
400	1"-11	1"-11	52,0	18	18	23,5	41	1050521-16-16	23,15
200	1 1/4"-11	1 1/4"-11	58,0	20	20	30,0	50	1050521-20-20	32,90
200	1 1/2"-11	1 1/2"-11	61,0	22	22	37,0	55	1050521-24-24	42,95
100	2"-11	2"-11	67,0	25	25	45,0	70	1050521-32-32	89,70
70	2 1/2"-11	2 1/2"-11	70,0	26	26	51,0	90	1050521-40-40	172,50

GERADE ADAPTER STRAIGHT ADAPTORS

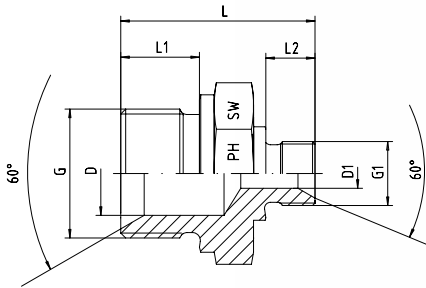

BSP - BSP
Mit 60°-Innenkonus und angedrehter Dichtkante Form B
Männlich - Männlich

BSP - BSP
With 60°-Cone and Sealing Shoulder Form B
BSP - Male - Male

Druck Pressure PN	Gewinde Thread		Ca. Maße Approx. Dimensions						Bestellzeichen Order-Code	Brutto-Preis Gross-Price Euro (€)
	G = BSP	G1 = BSP	L	L1	L2	D	D1	SW		
400	1/4"-19	1/8"-28	28,0	12,0	8	6,0	4,5	19	1050510-04-02	5,30
400	3/8"-19	1/8"-28	30,5	12,0	8	9,0	4,5	22	1050510-06-02	7,30
400	3/8"-19	1/4"-19	33,0	12,0	10	9,0	6,0	22	1050510-06-04	6,60
400	1/2"-14	1/8"-28	34,0	14,0	8	13	4,5	27	1050510-08-02	9,35
400	1/2"-14	1/4"-19	38,0	14,0	11	12,5	7,0	27	1050510-08-04	9,00
400	1/2"-14	3/8"-19	40,0	14,0	12	13,0	9,0	27	1050510-08-06	8,90
400	5/8"-14	3/8"-19	40,0	14,0	12	14,0	8,0	30	1050510-10-06	16,80
400	5/8"-14	1/2"-14	42,0	16,0	14	14,5	11,5	30	1050510-10-08	14,15
400	3/4"-14	1/4"-19	39,5	16,0	10	18,0	6,0	32	1050510-12-04	17,95
400	3/4"-14	3/8"-19	41,0	16,0	12	18,0	9,0	32	1050510-12-06	15,15
400	3/4"-14	1/2"-14	45,0	16,0	14	18,0	13,0	32	1050510-12-08	14,10
400	3/4"-14	5/8"-14	45,0	16,0	16	17,0	14,5	32	1050510-12-10	16,05
400	1"-11	3/8"-19	47,0	18,0	12	23,0	9,0	41	1050510-16-06	24,50
400	1"-11	1/2"-14	48,0	18,0	14	23,5	13,0	41	1050510-16-08	23,50
400	1"-11	3/4"-14	53,0	18,0	16	23,5	17,0	41	1050510-16-12	22,00
200	1 1/4"-11	1/2"-14	51,0	20,0	14	30,0	13,0	50	1050510-20-08	37,95
200	1 1/4"-11	3/4"-14	53,5	20,0	16	30,5	18,0	50	1050510-20-12	33,50
200	1 1/4"-11	1"-11	58,0	20,0	18	30,5	23,0	50	1050510-20-16	31,50
200	1 1/2"-11	3/4"-14	55,0	22,0	16	37,0	17,0	55	1050510-24-12	56,80
200	1 1/2"-11	1"-11	57,0	22,0	18	37,0	23,5	55	1050510-24-16	50,75
200	1 1/2"-11	1 1/4"-11	61,0	22,0	20	37,0	30,0	55	1050510-24-20	48,50
100	2"-11	1"-11	62,0	25,0	18	43,0	23,5	70	1050510-32-16	99,90
100	2"-11	1 1/4"-11	62,0	25,0	20	45,0	30,0	70	1050510-32-20	92,50
100	2"-11	1 1/2"-11	64,0	25,0	22	45,0	37,0	70	1050510-32-24	82,00

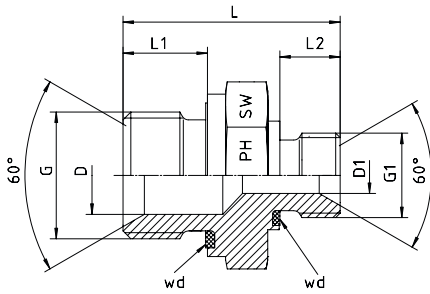

BSP - BSP

Mit 60°-Innenkonus
wd = Abdichtung durch Profildichtung - Viton
Männlich - Männlich

BSP - BSP

With 60°-Cone
wd = Sealing by an Elastomer Profiled Ring - Viton
Male - Male - Parallel

Druck Pressure PN	Gewinde Thread		Ca. Maße Approx. Dimensions						Bestellzeichen Order-Code	Brutto-Preis Gross-Price Euro (€)
	G = BSP	G1 = BSP	L	L1	L2	D	D1	SW		
400	1/4"-19	1/8"-28	28,0	12,0	8	6,0	4,5	19	1050508-04-02	8,75
400	3/8"-19	1/8"-28	30,5	12,0	8	9,0	4,5	22	1050508-06-02	12,10
400	3/8"-19	1/4"-19	33,0	12,0	10	9,0	6,0	22	1050508-06-04	10,90
400	1/2"-14	1/4"-19	38,0	14,0	11	12,5	7,0	27	1050508-08-04	14,85
400	1/2"-14	3/8"-19	40,0	14,0	12	13,0	9,0	27	1050508-08-06	14,85
400	3/4"-14	1/4"-19	39,5	16,0	10	18,0	6,0	32	1050508-12-04	29,70
400	3/4"-14	3/8"-19	41,0	16,0	12	18,0	9,0	32	1050508-12-06	25,30
400	3/4"-14	1/2"-14	45,0	16,0	14	18,0	13,0	32	1050508-12-08	23,30
400	1"-11	3/8"-19	47,0	18,0	12	23,0	9,0	41	1050508-16-06	41,80
400	1"-11	1/2"-14	48,0	18,0	14	23,5	13,0	41	1050508-16-08	40,70
400	1"-11	3/4"-14	53,0	18,0	16	23,5	17,0	41	1050508-16-12	39,60
200	1 1/4"-11	1/2"-14	51,0	20,0	14	30,0	13,0	50	1050508-20-08	62,70
200	1 1/4"-11	3/4"-14	53,5	20,0	16	30,5	18,0	50	1050508-20-12	61,60
200	1 1/4"-11	1"-11	58,0	20,0	18	30,5	23,0	50	1050508-20-16	60,50
200	1 1/2"-11	3/4"-14	55,0	22,0	16	37,0	17,0	55	1050508-24-12	97,90
200	1 1/2"-11	1"-11	57,0	22,0	18	37,0	23,5	55	1050508-24-16	95,70
200	1 1/2"-11	1 1/4"-11	61,0	22,0	20	37,0	30,0	55	1050508-24-20	94,60
100	2"-11	1"-11	62,0	25,0	18	43,0	23,5	70	1050508-32-16	176,00
100	2"-11	1 1/4"-11	62,0	25,0	20	45,0	30,0	70	1050508-32-20	176,00
100	2"-11	1 1/2"-11	64,0	25,0	22	45,0	37,0	70	1050508-32-24	176,00

GERADE ADAPTER STRAIGHT ADAPTORS

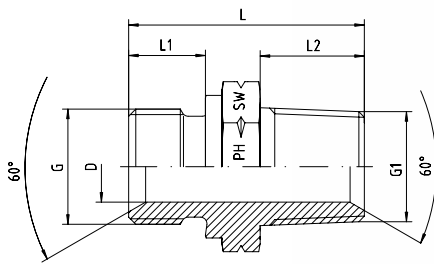

BSP - Zylindrisch - Männlich
mit 60°-Konus und angedrehter Dichtkante Form B
NPT - Männlich mit 60°-Konus
Andere Größen auf Anfrage!

BSP - Male
with 60°-Cone and Sealing Shoulder Form B
NPT - Male with 60°-Cone
Other sizes on request!

Druck Pressure PN	Gewinde Thread		Ca. Maße Approx. Dimensions					Bestellzeichen Order-Code BSP x NPT	Brutto-Preis Gross-Price Euro (€)
	G = BSP	G1 = NPT	L	L1	L2	D	SW		
400	1/8"-28	1/8"-27	24,5	8	10,0	4,0	14	1052810-02-02	6,10
400	1/4"-19	1/4"-18	32,5	10	15,0	6,0	19	1052810-04-04	5,37
400	3/8"-19	3/8"-18	38,0	12	15,3	9,0	22	1052810-06-06	6,75
400	1/2"-14	1/2"-14	43,0	14	20,0	12,5	27	1052810-08-08	9,20
400	3/4"-14	3/4"-14	47,0	16	20,0	17,5	32	1052810-12-12	12,50
400	1"-11	1"-11,5	54,5	18	25,0	22,5	41	1052810-16-16	20,00
200	1 1/4"-11	1 1/4"-11,5	66,0	20	25,5	30,0	50	1052810-20-20	32,90
200	1 1/2"-11	1 1/2"-11,5	64,0	22	26,0	37,0	55	1052810-24-24	55,50
100	2"-11	2"-11,5	66,0	25	26,0	45,0	70	1052810-32-32	99,00

Druck Pressure PN	Gewinde Thread		Ca. Maße Approx. Dimensions					Bestellzeichen Order-Code BSP x NPT	Brutto-Preis Gross-Price Euro (€)
	G = BSP	G1 = NPT	L	L1	L2	D	SW		
400	1/8"-28	1/4"-18	30,0	8	15,0	4,0	14	1052810-02-04	10,40
400	1/4"-19	1/8"-27	27,5	10	10,0	4,0	19	1052810-04-02	10,40
400	1/4"-19	3/8"-18	33,0	10	15,3	6,0	19	1052810-04-06	8,70
400	1/4"-19	1/2"-14	40,0	10	20,0	6,0	22	1052810-04-08	11,90
400	3/8"-19	1/4"-18	35,5	12	15,0	7,0	22	1052810-06-04	8,70
400	3/8"-19	1/2"-14	42,0	12	20,0	9,0	22	1052810-06-08	10,50
400	3/8"-19	3/4"-14	42,0	12	20,0	9,0	27	1052810-06-12	18,75
400	1/2"-14	1/4"-18	40,0	14	15,0	7,0	27	1052810-08-04	13,95
400	1/2"-14	3/8"-18	40,0	14	15,3	9,0	27	1052810-08-06	11,40
400	1/2"-14	3/4"-14	45,0	14	20,0	12,0	27	1052810-08-12	18,50
400	3/4"-14	1/2"-14	45,0	16	20,0	12,5	32	1052810-12-08	19,40
400	3/4"-14	1"-11,5	52,0	16	25,0	17,5	36	1052810-12-16	23,95
400	1"-11	3/8"-18	45,0	18	15,3	9,0	41	1052810-16-06	28,75
400	1"-11	1/2"-14	50,0	18	20,0	12,5	41	1052810-16-08	23,95
400	1"-11	3/4"-14	50,0	18	20,0	15,0	41	1052810-16-12	23,95

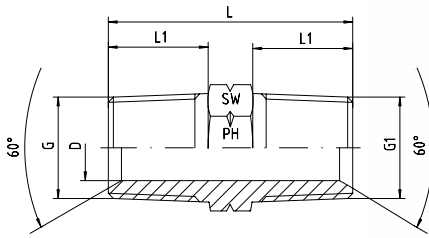

NPT - Männlich mit 60°-Konus

NPT - Male with 60°-Cone

Druck Pressure PN	Gewinde Thread		Ca. Maße Approx. Dimensions				Bestellzeichen Order-Code	Brutto-Preis Gross-Price Euro (€)
	G = NPT	G1 = NPT	L	L1	D	SW		
630	1/8"-27	1/8"-27	27,0	10,0	5,0	12	1282810-02-02	7,50
630	1/4"-18	1/4"-18	36,5	15,0	7,0	14	1282810-04-04	6,40
630	3/8"-18	3/8"-18	36,5	15,3	9,0	19	1282810-06-06	7,10
630	1/2"-14	1/2"-14	48,4	20,0	13,5	22	1282810-08-08	8,65
630	3/4"-14	3/4"-14	50,0	20,0	18,0	27	1282810-12-12	13,25
400	1"-11,5	1"-11,5	59,0	25,0	21,0	36	1282810-16-16	18,10
400	1 1/4"-11,5	1 1/4"-11,5	63,0	25,5	31,5	46	1282810-20-20	39,90
400	1 1/2"-11,5	1 1/2"-11,5	65,0	26,0	36,0	50	1282810-24-24	55,00
315	2"-11,5	2"-11,5	68,0	26,0	46,0	65	1282810-32-32	85,00

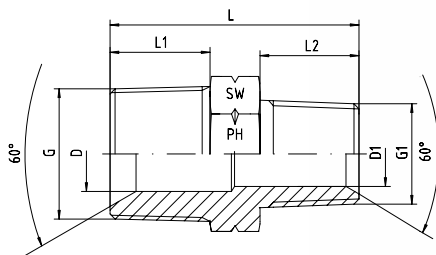

NPT - Männlich mit 60-Konus

NPT - Male with 60°-Cone

Druck Pressure PN	Gewinde Thread		Ca. Maße Approx. Dimensions						Bestellzeichen Order-Code	Brutto-Preis Gross-Price Euro (€)
	G = NPT	G1 = NPT	L	L1	L2	D	D1	SW		
630	1/4"-18	1/8"-27	32,0	15,0	10,0	7,0	5,0	14	1282810-04-02	12,00
630	3/8"-18	1/4"-18	36,5	15,3	15,0	7,0	7,0	19	1282810-06-04	12,00
630	1/2"-14	1/4"-18	43,0	20,0	15,0	7,0	7,0	22	1282810-08-04	13,95
630	1/2"-14	3/8"-18	43,7	20,0	15,3	13,5	8,0	22	1282810-08-06	13,00
630	3/4"-14	1/2"-14	50,0	20,0	20,0	18,0	13,5	27	1282810-12-08	18,90
400	1"-11,5	1/2"-14	54,0	25,0	20,0	21,0	13,5	36	1282810-16-08	31,95
400	1"-11,5	3/4"-14	54,2	25,0	20,0	21,0	18,0	36	1282810-16-12	29,00

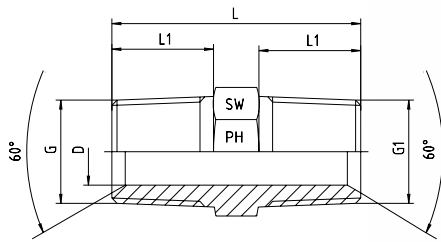

BSP - Kegelig
BSP - Kegelig

BSP - Taper
BSP - Taper

Druck Pressure PN	Gewinde Thread		Ca. Maße Approx. Dimensions				Bestellzeichen Order-Code	Brutto-Preis Gross-Price Euro (€)
	G = BSPT	G1 = BSPT	L	L1	D	SW		
400	1/8"-28	1/8"-28	22,0	8	4,0	12	1070710-02-02	7,50
400	1/4"-19	1/4"-19	30,0	12	5,0	14	1070710-04-04	6,30
400	3/8"-19	3/8"-19	31,0	12	8,0	19	1070710-06-06	6,85
400	1/2"-14	1/2"-14	38,0	14	13,5	22	1070710-08-08	8,80
400	3/4"-14	3/4"-14	43,0	16	18,0	27	1070710-12-12	13,65
400	1"-11	1"-11	47,0	18	22,5	36	1070710-16-16	18,75
200	1 1/4"-11	1 1/4"-11	52,0	20	29,0	46	1070710-20-20	39,90
200	1 1/2"-11	1 1/2"-11	58,0	22	33,5	50	1070710-24-24	55,00
100	2"-11	2"-11	68,0	26	46,0	65	1070710-32-32	85,00

GERADE ADAPTER STRAIGHT ADAPTORS



EDELSTAHL / STAINLESS STEEL
VERBINDUNGSTECHNIK
FLUID CONNECTORS

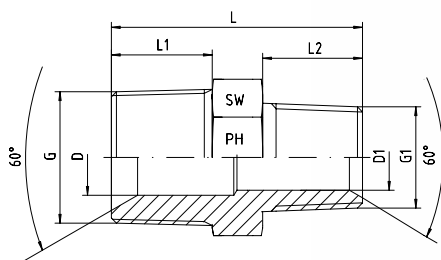

BSP - Kegelig
BSP - Kegelig

BSP - Taper
BSP - Taper

Druck Pressure PN	Gewinde Thread		Ca. Maße Approx. Dimensions						Bestellzeichen Order-Code	Brutto-Preis Gross-Price Euro (€)
	G = BSPT	G1 = BSPT	L	L1	L2	D	D1	SW		
400	1/4"-19	1/8"-28	26,0	12	8	5,0	5,0	14	1070710-04-02	12,00
400	3/8"-19	1/4"-19	31,0	12	12	8,0	8,0	19	1070710-06-04	10,90
400	1/2"-14	3/8"-19	34,0	14	12	11,5	8,0	22	1070710-08-06	11,50
400	3/4"-14	1/2"-14	39,0	16	14	18,0	13,5	27	1070710-12-08	18,90
400	1"-11	3/4"-14	45,0	18	19	22,5	17,0	36	1070710-16-12	29,00
200	1 1/4"-11	1"-11	50,0	20	18	29,0	22,5	46	1070710-20-16	45,00
200	1 1/2"-11	1 1/4"-11	56,0	22	20	33,5	29,0	50	1070710-24-20	63,90

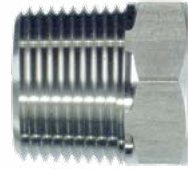
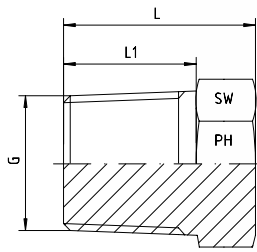

BSP - Kegelig

BSP - Taper

Druck Pressure PN	Gewinde Thread G = BSPT	Ca. Maße Approx. Dimensions			Bestellzeichen Order-Code	Brutto-Preis Gross-Price Euro (€)
		L	L1	SW		
400	1/8"-28	14	8	12	5070010-02	4,50
400	1/4"-19	18	12	14	5070010-04	4,60
400	3/8"-19	19	12	17	5070010-06	5,30
400	1/2"-14	27	19	22	5070010-08	6,50
400	3/4"-14	29	19	27	5070010-12	8,75
400	1"-11	29	18	36	5070010-16	13,75
200	1 1/4"-11	32	20	46	5070010-20	21,25
200	1 1/2"-11	36	22	50	5070010-24	27,50
100	2"-11	40	26	65	5070010-32	56,50

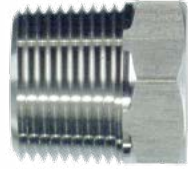
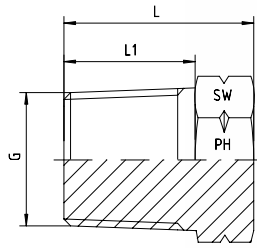

NPT - Männlich

NPT - Male

Druck Pressure PN	Gewinde Thread G = NPT	Ca. Maße Approx. Dimensions			Bestellzeichen Order-Code	Brutto-Preis Gross-Price Euro (€)
		L	L1	SW		
630	1/8"-27	15	10,0	12	5280010-02	4,50
630	1/4"-18	20	15,0	14	5280010-04	4,60
630	3/8"-18	22	15,3	17	5280010-06	5,30
630	1/2"-14	27	20,0	22	5280010-08	6,50
630	3/4"-14	29	20,0	27	5280010-12	8,75
400	1"-11,5	33	25,0	36	5280010-16	13,75
400	1 1/4"-11,5	33	25,5	46	5280010-20	21,25
400	1 1/2"-11,5	41	26,0	50	5280010-24	27,50
315	2"-11,5	44	26,0	65	5280010-32	56,50



BSP - Weiblich
mit drehbarer Mutter für 60°-Gegenanschluss
BSP - Kegelig - Männlich

BSP - Female
with Swivel Nut for 60°-Connection
BSP - Taper - Male

Druck Pressure PN	Gewinde Thread		Ca. Maße Approx. Dimensions					Bestellzeichen Order-Code	Brutto-Preis Gross-Price Euro (€)
	G1 = BSP	G = BSPT	L	L1	D	SW	SW1		
400	1/8"-28	1/8"-28	23,0	8	4,0	12	14	2070511-02-02	15,80
400	1/4"-19	1/4"-19	28,0	12	5,0	14	19	2070511-04-04	15,80
400	3/8"-19	3/8"-19	30,6	12	8,0	19	22	2070511-06-06	18,30
400	1/2"-14	1/2"-14	37,0	14	9,5	24	27	2070511-08-08	22,55
400	3/4"-14	3/4"-14	39,0	16	16,5	27	32	2070511-12-12	26,90
400	1"-11	1"-11	44,3	18	22,5	36	41	2070511-16-16	35,30
200	1 1/4"-11	1 1/4"-11	51,9	20	29,0	46	50	2070511-20-20	70,55
200	1 1/2"-11	1 1/2"-11	54,6	22	33,5	50	55	2070511-24-24	95,95
100	2"-11	2"-11	69,0	26	42,0	65	70	2070511-32-32	130,55

GERADE ADAPTER STRAIGHT ADAPTORS

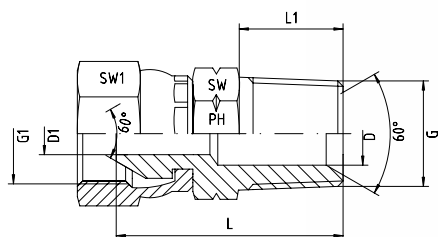

BSP - Weiblich
mit drehbarer Mutter für 60°-Gegenanschluss
NPT - Männlich

BSP - Female
with Swivel Nut for 60°-Connection
NPT - Male

Druck Pressure PN	Gewinde Thread		Ca. Maße Approx. Dimensions						Bestellzeichen Order-Code BSP x NPT	Brutto-Preis Gross-Price Euro (€)
	G1 = BSP	G = NPT	L	L1	D	D1	SW	SW1		
400	1/8"-28	1/8"-27	25,0	10,0	4,0	4,0	12	14	2280511-02-02	14,80
400	1/4"-19	1/4"-18	32,0	15,0	7,0	5,0	14	19	2280511-04-04	14,80
400	1/4"-19	3/8"-18	32,0	15,3	10,3	5,0	19	19	2280511-04-06	18,00
400	3/8"-19	1/4"-18	33,6	15,0	7,0	7,0	17	22	2280511-06-04	18,00
400	3/8"-19	3/8"-18	33,0	15,3	10,0	8,0	19	22	2280511-06-06	17,00
400	3/8"-19	1/2"-14	40,8	20,0	13,5	8,0	22	22	2280511-06-08	21,80
400	1/2"-14	3/8"-18	34,8	15,3	10,3	9,5	19	27	2280511-08-06	21,80
400	1/2"-14	1/2"-14	42,0	20,0	13,5	9,5	22	27	2280511-08-08	19,95
400	1/2"-14	3/4"-14	41,0	20,0	16,5	9,5	27	27	2280511-08-12	26,50
400	3/4"-14	1/2"-14	43,0	20,0	13,5	16,5	27	32	2280511-12-08	26,50
400	3/4"-14	3/4"-14	43,0	20,0	16,5	16,5	27	32	2280511-12-12	25,00
400	3/4"-14	1"-11,5	48,5	25,0	24,0	16,5	36	32	2280511-12-16	38,50
400	1"-11	1"-11	49,5	25,0	24,0	21,0	36	41	2280511-16-16	33,90
200	1 1/4"-11	1 1/4"-11,5	53,0	25,5	28,0	28,0	46	50	2280511-20-20	68,50
200	1 1/2"-11	1 1/2"-11,5	57,0	26,0	32,5	32,5	50	55	2280511-24-24	90,45
100	2"-11	2"-11,5	69,0	26,0	42,0	42,0	65	70	2280511-32-32	145,00

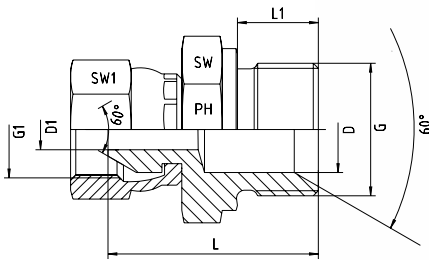

BSP - Weiblich mit drehbarer Mutter
BSP - Männlich
mit 60°-Konus und angedrehter Dichtkante Form B

BSP - Female with Swivel Nut
BSP - Male
with 60°-Cone and Sealing Shoulder Form B

Druck Pressure PN	Gewinde Thread		Ca. Maße Approx. Dimensions						Bestellzeichen Order-Code G1 x G	Brutto-Preis Gross-Price Euro (€)
	G1	G	L	L1	D	D1	SW	SW1		
400	1/8"-28	1/8"-28	23,5	8	4,0	4,0	14	14	2050511-02-02	10,95
400	1/8"-28	1/4"-19	27,5	12	4,0	4,0	19	14	2050511-02-04	12,95
400	1/4"-19	1/8"-28	27,0	8	4,0	4,0	14	19	2050511-04-02	9,75
400	1/4"-19	1/4"-19	30,0	12	5,0	5,0	19	19	2050511-04-04	9,75
400	1/4"-19	3/8"-19	31,5	12	9,0	5,0	22	19	2050511-04-06	13,95
400	1/4"-19	1/2"-14	35,5	14	11,5	5,0	27	19	2050511-04-08	23,95
400	3/8"-19	1/8"-28	26,0	8	4,5	4,5	17	19	2050511-06-02	12,95
400	3/8"-19	1/4"-19	31,5	12	5,0	8,0	19	22	2050511-06-04	12,70
400	3/8"-19	3/8"-19	32,5	12	8,0	8,0	22	22	2050511-06-06	11,90
400	3/8"-19	1/2"-14	37,0	14	11,5	8,0	27	22	2050511-06-08	18,75
400	1/2"-14	1/4"-19	31,5	12	5,0	11,0	19	27	2050511-08-04	23,95
400	1/2"-14	3/8"-19	32,5	12	9,0	9,0	22	27	2050511-08-06	15,30
400	1/2"-14	1/2"-14	36,0	14	11,0	11,0	27	27	2050511-08-08	15,40
400	1/2"-14	3/4"-14	39,5	16	11,0	11,0	32	27	2050511-08-12	27,50
400	3/4"-14	1/2"-14	42,0	14	11,5	16,0	27	32	2050511-12-08	22,70
400	3/4"-14	3/4"-14	41,0	16	16,5	16,5	32	32	2050511-12-12	19,50
400	3/4"-14	1"-11	45,0	18	22,5	16,5	41	32	2050511-12-16	41,60
400	1"-11	3/4"-14	44,0	18	17,0	22,0	32	41	2050511-16-12	38,00
400	1"-11	1"-11	45,5	18	22,0	22,0	41	41	2050511-16-16	35,75
200	1"-11	1 1/4"-11	49,5	20	29,0	22,5	50	41	2050511-16-20	78,00
200	1 1/4"-11	1"-11	53,0	18	22,0	22,0	41	50	2050511-20-16	59,90
200	1 1/4"-11	1 1/4"-11	48,5	20	28,0	28,0	50	50	2050511-20-20	59,25
200	1 1/2"-11	1 1/2"-11	53,0	22	33,0	33,0	55	55	2050511-24-24	73,50
100	2"-11	2"-11	72,0	23	42,0	42,0	70	70	2050511-32-32	145,00

GERADE ADAPTER - DKR

STRAIGHT ADAPTORS - DKR

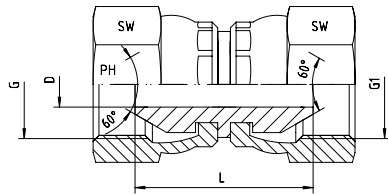

Weiblich - BSP - BSP
mit drehbarer Mutter an beiden Seiten

Female - BSP - BSP
with Swivel Nut at both sides

Druck Pressure PN	Gewinde Thread		Ca. Maße Approx. Dimensions			Bestellzeichen Order-Code	Brutto-Preis Gross-Price Euro (€)
	G	G1	L	D	SW		
400	1/8"-28	1/8"-28	21	4,0	14	3050511-02-02	15,45
400	1/4"-19	1/4"-19	26	5,0	19	3050511-04-04	13,95
400	3/8"-19	3/8"-19	30	8,0	22	3050511-06-06	16,15
400	1/2"-14	1/2"-14	29	11,0	27	3050511-08-08	17,15
400	3/4"-14	3/4"-14	34	16,5	32	3050511-12-12	24,85
400	1"-11	1"-11	36	22,0	41	3050511-16-16	40,85
200	1 1/4"-11	1 1/4"-11	38	28,0	50	3050511-20-20	78,75
200	1 1/2"-11	1 1/2"-11	51	34,0	55	3050511-24-24	113,60
100	2"-11	2"-11	66	42,0	70	3050511-32-32	189,50

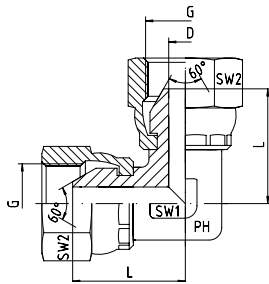

Weiblich - BSP - BSP
 mit drehbarer Mutter an beiden Seiten

Female - BSP - BSP
 with Swivel Nut at both sides

Druck Pressure PN	Gewinde Thread G	Ca. Maße Approx. Dimensions				Bestellzeichen Order-Code	Brutto-Preis Gross-Price Euro (€)
		L	D	SW1	SW2		
400	1/8"-28	18,0	4,0	12	14	4050511-02	32,90
400	1/4"-19	23,5	6,0	14	19	4050511-04	30,10
400	3/8"-19	25,5	8,0	17	22	4050511-06	28,90
400	1/2"-14	29,5	11,0	19	27	4050511-08	39,50
400	3/4"-14	37,0	16,0	27	32	4050511-12	53,30
400	1"-11	43,0	22,0	36	41	4050511-16	80,20
200	1 1/4"-11	51,0	28,0	41	50	4050511-20	155,00
200	1 1/2"-11	50,0	33,5	50	55	4050511-24	225,00
100	2"-11	80,0	42,0	65	70	4050511-32	414,00

T-ADAPTER - DKR

T-ADAPTORS - DKR



EDELSTAHL / STAINLESS STEEL
VERBINDUNGSTECHNIK
FLUID CONNECTORS

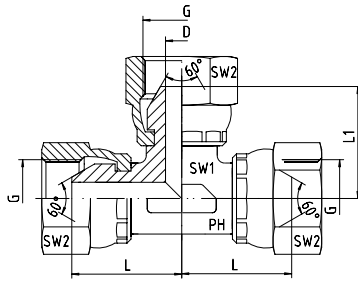

Weiblich - BSP - BSP - BSP
mit drehbarer Mutter an allen Seiten

Female - BSP - BSP - BSP
with Swivel Nut at both sides

Druck Pressure PN	Gewinde Thread G	Ca. Maße Approx. Dimensions					Bestellzeichen Order-Code	Brutto-Preis Gross-Price Euro (€)
		L	L1	D	SW1	SW2		
400	1/8"-28	18,0	18,0	4,0	12	14	4150511-02	49,50
400	1/4"-19	23,5	23,5	6,0	14	19	4150511-04	38,75
400	3/8"-19	25,5	25,5	8,0	17	22	4150511-06	41,47
400	1/2"-14	29,5	29,5	11,0	19	27	4150511-08	52,90
400	3/4"-14	37,0	37,0	16,0	27	32	4150511-12	78,75
400	1"-11	43,0	43,0	22,0	36	41	4150511-16	101,25
200	1 1/4"-11	51,0	51,0	28,0	41	50	4150511-20	170,20
200	1 1/2"-11	50,0	50,0	33,5	50	55	4150511-24	218,10
100	2"-11	80,0	80,0	42,0	65	70	4150511-32	815,00



Druck Pressure PN	Gewinde Thread G	Ca. Maße Approx. Dimensions					Bestellzeichen Order-Code	Brutto-Preis Gross-Price Euro (€)
		L	L1	D	SW1	SW2		
400	1/8"-28	18,0	18,0	4,0	12		4250511-02	99,00
400	1/4"-19	23,5	23,5	6,0	14	19	4250511-04	77,50
400	3/8"-19	25,5	25,5	8,0	17	22	4250511-06	82,95
400	1/2"-14	29,5	29,5	11,0	19	27	4250511-08	105,80
400	3/4"-14	37,0	37,0	16,0	27	32	4250511-12	157,50
400	1"-11	43,0	43,0	22,0	36	41	4250511-16	202,50
200	1 1/4"-11					50	4250511-20	*
200	1 1/2"-11					55	4250511-24	*
	2"-11					70	4250511-32	*

WINKEL-ADAPTER ELBOW-ADAPTORS

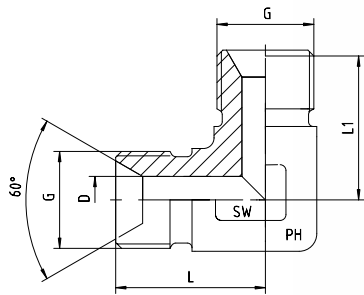

Männlich - BSP - BSP
mit 60°-Konus

Male - BSP - BSP
with 60°-Cone

Druck Pressure PN	Gewinde Thread G	Ca. Maße Approx. Dimensions				Bestellzeichen Order-Code	Brutto-Preis Gross-Price Euro (€)
		L	L1	D	SW		
400	1/8"-28	20,0	20,0	4,0	12	1350510-02	10,00
400	1/4"-19	24,5	24,5	6,0	14	1350510-04	11,00
400	3/8"-19	25,5	25,5	8,0	17	1350510-06	15,50
400	1/2"-14	29,5	29,5	11,0	19	1350510-08	19,50
400	3/4"-14	37,0	37,0	16,0	27	1350510-12	37,50
400	1"-11	43,0	43,0	22,0	36	1350510-16	44,90
200	1 1/4"-11	51,0	51,0	28,5	41	1350510-20	78,90
200	1 1/2"-11	59,0	59,0	33,5	50	1350510-24	150,00
100	2"-11	77,5	77,5	45,0	65	1350510-32	290,00

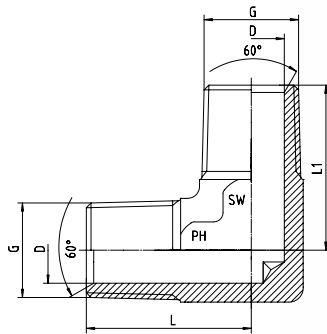

Männlich - NPT - NPT
mit 60°-Konus

Male - NPT - NPT
with 60°-Cone

Druck Pressure PN	Gewinde Thread G = NPT	Ca. Maße Approx. Dimensions				Bestellzeichen Order-Code	Brutto-Preis Gross-Price Euro (€)
		L	L1	D	SW		
420	1/8"-27	20,0	20,0	5,0	12	1350511-02	10,00
420	1/4"-18	28,0	28,0	7,0	14	1350511-04	12,25
420	3/8"-18	31,0	31,0	10,0	19	1350511-06	16,25
420	1/2"-14	35,0	35,0	14,0	24	1350511-08	23,75
420	3/4"-14	40,0	40,0	18,0	36	1350511-12	45,00
420	1"-11,5	50,0	50,0	24,0	41	1350511-16	80,00
315	1 1/4"-11,5	56,0	56,0	30,0	50	1350511-20	165,00
315	1 1/2"-11,5	59,0	59,0	37,0	50	1350511-24	189,00
315	2"-11,5	76,0	76,0	45,0	65	1350511-32	395,00

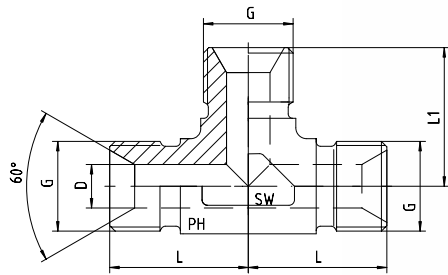

Männlich - BSP - BSP - BSP
mit 60°-Konus

Male - BSP - BSP - BSP
with 60°-Cone

Druck Pressure PN	Gewinde Thread G	Ca. Maße Approx. Dimensions				Bestellzeichen Order-Code	Brutto-Preis Gross-Price Euro (€)
		L	L1	D	SW		
400	1/8"-28	20,0	20,0	4,0	12	1450510-02	18,30
400	1/4"-19	24,5	24,5	6,0	14	1450510-04	18,50
400	3/8"-19	25,5	25,5	8,0	17	1450510-06	21,50
400	1/2"-14	29,5	29,5	11,0	19	1450510-08	22,00
400	3/4"-14	37,0	37,0	16,0	27	1450510-12	38,60
400	1"-11	43,0	43,0	22,0	36	1450510-16	53,60
200	1 1/4"-11	51,0	51,0	28,5	41	1450510-20	92,40
200	1 1/2"-11	59,0	59,0	33,5	50	1450510-24	159,20
100	2"-11	77,5	77,5	45,0	65	1450510-32	357,50

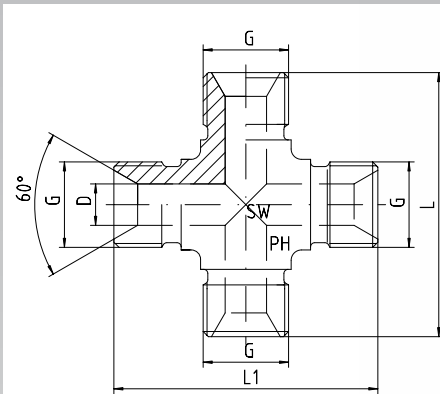

Männlich - BSP
 alle Seiten mit 60°-Konus

Male - BSP
 all sides with 60°-Cone

Druck Pressure PN	Gewinde Thread G	Ca. Maße Approx. Dimensions				Bestellzeichen Order-Code	Brutto-Preis Gross-Price Euro (€)
		L	L1	D	SW		
400	1/8"-28					1550510-02	114,30
400	1/4"-19					1550510-04	114,30
400	3/8"-19					1550510-06	117,32
400	1/2"-14					1550510-08	125,70
400	3/4"-14					1550510-12	172,90
400	1"-11					1550510-16	262,05
200	1 1/4"-11					1550510-20	367,50
200	1 1/2"-11					1550510-24	400,10
	2"-11					1550510-32	995,00

WE-KOMPAKT-WINKEL-ADAPTER - 90°

WE-BLOCK-ELBOW-ADAPTORS - 90°



EDELSTAHL / STAINLESS STEEL
VERBINDUNGSTECHNIK
FLUID CONNECTORS

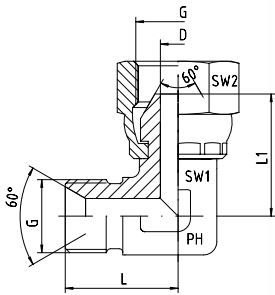

Männlich - Starr mit 60°-Konus
Weiblich - Mit drehbarer Mutter

Male - Fixed with 60°-Cone
Female - With Swivel Nut

Druck Pressure PN	Gewinde Thread G	Ca. Maße Approx. Dimensions					Bestellzeichen Order-Code	Brutto-Preis Gross-Price Euro (€)
		L	L1	D	SW1	SW2		
400	1/8"-28	20,0	18,0	4,0	12	14	1560510-02	19,35
400	1/4"-19	24,5	23,5	6,0	14	19	1560510-04	20,60
400	3/8"-19	25,5	25,5	8,0	17	22	1560510-06	23,30
400	1/2"-14	29,5	29,5	11,0	19	27	1560510-08	27,60
400	3/4"-14	37,0	37,0	16,0	27	32	1560510-12	48,55
400	1"-11	43,0	43,0	22,0	36	41	1560510-16	59,20
200	1 1/4"-11	51,0	51,0	28,0	41	50	1560510-20	74,55
200	1 1/2"-11	59,0	50,0	33,5	50	55	1560510-24	155,00
100	2"-11	77,5	80,0	42,0	65	70	1560510-32	345,00

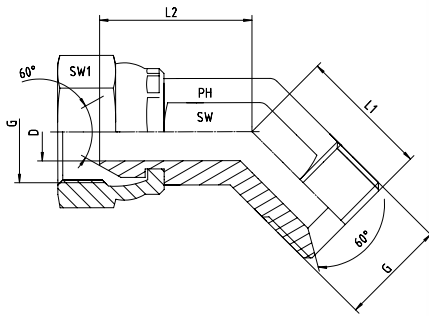

Männlich - Starr mit 60°-Konus
Weiblich - Mit drehbarer Mutter

Male - Fixed with 60°-Cone
Female - With Swivel Nut

Druck Pressure PN	Gewinde Thread G	Ca. Maße Approx. Dimensions					Bestellzeichen Order-Code	Brutto-Preis Gross-Price Euro (€)
		L1	L2	D	SW	SW1		
400	1/8"-28	14,0	15,0	3,5	12	14	1545510-02	25,15
400	1/4"-19	21,0	19,0	5,0	14	19	1545510-04	26,80
400	3/8"-19	21,5	20,5	8,0	16	22	1545510-06	30,30
400	1/2"-14	23,5	22,5	11,0	22	27	1545510-08	35,90
400	3/4"-14	31,0	25,0	17,0	27	32	1545510-12	63,10
400	1"-11	36,5	27,0	22,0	33	41	1545510-16	76,95
200	1 1/4"-11						1545510-20	320,00
200	1 1/2"-11						1545510-24	436,00
100	2"-11	56,4	59,0	42,0	65	70	1545510-32	614,00

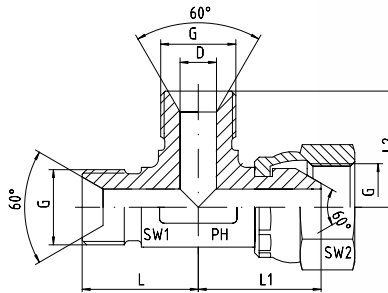

Männlich - Starr - BSP mit 60°-Konus
Weiblich - Drehbar - BSP

Male - Fixed - BSP with 60°-Cone
Female - Swivel - BSP

Druck Pressure PN	Gewinde Thread G	Ca. Maße Approx. Dimensions						Bestellzeichen Order-Code	Brutto-Preis Gross-Price Euro (€)
		L	L1	L2	D	SW1	SW2		
400	1/8"-28	20,0	18,0	20,0	4,0	12	14	1570510-02	37,50
400	1/4"-19	24,5	24,5	24,5	6,0	14	19	1570510-04	29,95
400	3/8"-19	25,5	25,5	25,5	8,0	17	22	1570510-06	32,30
400	1/2"-14	29,5	29,5	29,5	11,0	19	27	1570510-08	39,00
400	3/4"-14	37,0	37,0	37,0	16,0	27	32	1570510-12	59,80
400	1"-11	43,0	43,0	43,0	22,0	36	41	1570510-16	85,00
200	1 1/4"-11	51,0	51,0	51,0	28,0	41	50	1570510-20	110,90
200	1 1/2"-11	59,0	50,0	59,0	33,5	50	55	1570510-24	155,00
100	2"-11	77,5	80,0	77,5	42,0	65	70	1570510-32	750,00

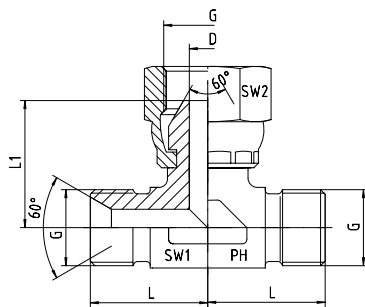

Männlich - Starr - BSP mit 60°-Konus
Weiblich - Drehbar - BSP

Male - Fixed - BSP with 60°-Cone
Female - Swivel - BSP

Druck Pressure PN	Gewinde Thread G	Ca. Maße Approx. Dimensions					Bestellzeichen Order-Code	Brutto-Preis Gross-Price Euro (€)
		L	L1	D	SW1	SW2		
400	1/8"-28	20,0	18,0	4,0	12	14	1580510-02	37,50
400	1/4"-19	24,5	23,5	6,0	14	19	1580510-04	29,95
400	3/8"-19	25,5	25,5	8,0	17	22	1580510-06	32,30
400	1/2"-14	29,5	29,5	11,0	19	27	1580510-08	39,00
400	3/4"-14	37,0	37,0	16,0	27	32	1580510-12	59,80
400	1"-11	43,0	43,0	22,0	36	41	1580510-16	85,00
200	1 1/4"-11	51,0	51,0	28,0	41	50	1580510-20	110,90
200	1 1/2"-11	59,0	50,0	33,5	50	55	1580510-24	155,00
100	2"-11	77,5	80,0	42,0	65	70	1580510-32	750,00

WINKEL-ADAPTER ELBOW-ADAPTORS

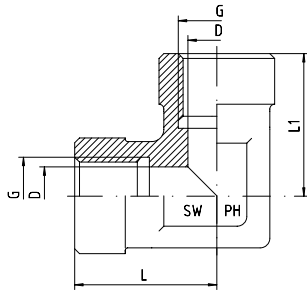

Weiblich - BSP - Zylindrisch - BSP - Zylindrisch

Female - BSP - Parallel - BSP - Parallel

Druck Pressure PN	Gewinde Thread G	Ca. Maße Approx. Dimensions				Bestellzeichen Order-Code	Brutto-Preis Gross-Price Euro (€)
		L	L1	D	SW		
400	1/8"-28	20,0	20,0	8,6	17	1350520-02	21,00
400	1/4"-19	22,5	22,5	11,8	19	1350520-04	21,00
400	3/8"-19	26,2	26,2	15,2	24	1350520-06	27,40
400	1/2"-14	31,5	31,5	19,0	27	1350520-08	34,90
400	3/4"-14	33,5	33,5	24,6	36	1350520-12	39,70
400	1"-11	43,0	43,0	30,7	41	1350520-16	47,50
200	1 1/4"-11	51,0	51,0	39,3	50	1350520-20	127,80
200	1 1/2"-11	53,0	53,0	45,2	65	1350520-24	398,00
	2"-11					1350520-32	459,00

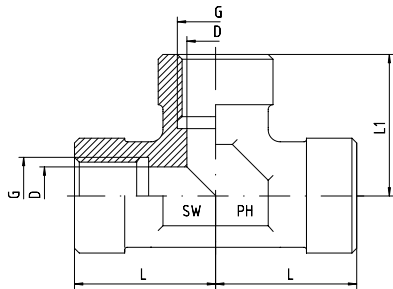

Weiblich - BSP - Zylindrisch - BSP - Zylindrisch -
BSP - Zylindrisch

Female - BSP - Parallel - BSP - Parallel -
BSP - Parallel - Fixed

Druck Pressure PN	Gewinde Thread G	Ca. Maße Approx. Dimensions				Bestellzeichen Order-Code	Brutto-Preis Gross-Price Euro (€)
		L	L1	D	SW		
400	1/8"-28	20,0	20,0	8,6	17	1450520-02	30,80
400	1/4"-19	22,5	22,5	11,8	19	1450520-04	30,80
400	3/8"-19	26,2	26,2	15,2	24	1450520-06	37,40
400	1/2"-14	31,5	31,5	19,0	27	1450520-08	51,70
400	3/4"-14	33,5	33,5	24,6	36	1450520-12	65,20
400	1"-11	43,0	43,0	30,7	41	1450520-16	75,30
200	1 1/4"-11	51,0	51,0	39,3	50	1450520-20	178,00
200	1 1/2"-11	53,0	53,0	45,2	65	1450520-24	622,00
	2"-11					1450520-32	649,00

WINKEL-ADAPTER - 90° ELBOW-ADAPTORS - 90°

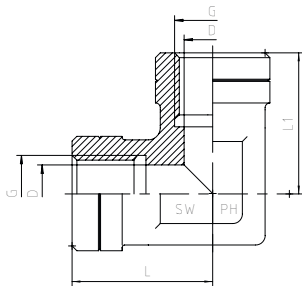

Weiblich - NPT - NPT

Female - NPT - NPT

Druck Pressure PN	Gewinde Thread G = NPT	Ca. Maße Approx. Dimensions				Bestellzeichen Order-Code	Brutto-Preis Gross-Price Euro (€)
		L	L1	D	SW		
420	1/8"-27	20,0	20,0	8,6	17	1350521-02	27,30
420	1/4"-18	22,5	22,5	11,8	19	1350521-04	27,30
420	3/8"-18	26,2	26,2	15,2	24	1350521-06	35,60
420	1/2"-14	31,5	31,5	19,0	27	1350521-08	45,40
420	3/4"-14	33,5	33,5	24,6	36	1350521-12	51,60
420	1"-11,5	43,0	43,0	30,7	41	1350521-16	61,75
315	1 1/4"-11,5	51,0	51,0	39,3	50	1350521-20	166,15
315	1 1/2"-11,5	53,0	53,0	45,2	65	1350521-24	517,40



Druck Pressure PN	Gewinde Thread G = NPT	Ca. Maße Approx. Dimensions				Bestellzeichen Order-Code	Brutto-Preis Gross-Price Euro (€)
		L	L1	D	SW		
420	1/8"-27	20,0	20,0	8,6	17	1450521-02	39,00
420	1/4"-18	22,5	22,5	11,8	19	1450521-04	39,00
420	3/8"-18	26,2	26,2	15,2	24	1450521-06	48,60
420	1/2"-14	31,5	31,5	19,0	27	1450521-08	67,20
420	3/4"-14	33,5	33,5	24,6	36	1450521-12	84,76
420	1"-11,5	43,0	43,0	30,7	41	1450521-16	97,80
315	1 1/4"-11,5	51,0	51,0	39,3	50	1450521-20	231,40
315	1 1/2"-11,5	53,0	53,0	45,2	65	1450521-24	808,60

WINKEL-ADAPTER - 90° ELBOW-ADAPTORS - 90°

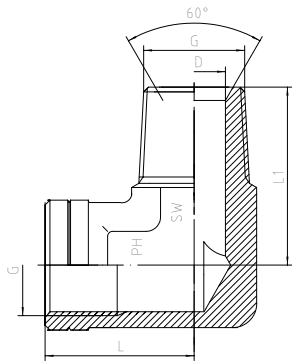

Männlich - NPT mit 60°-Konus - Weiblich - NPT

Male - NPT with 60°-Cone - Female - NPT

Druck Pressure PN	Gewinde Thread G = NPT	Ca. Maße Approx. Dimensions				Bestellzeichen Order-Code	Brutto-Preis Gross-Price Euro (€)
		L	L1	D	SW		
420	1/8"-27	20,0	22,0	5,0	17	1350512-02	26,90
420	1/4"-18	22,5	30,0	7,0	19	1350512-04	26,90
420	3/8"-18	26,3	32,0	10,0	24	1350512-06	35,20
420	1/2"-14	31,0	37,0	14,0	27	1350512-08	42,00
420	3/4"-14	33,5	43,0	18,0	36	1350512-12	49,00
420	1"-11,5	43,0	50,0	24,0	41	1350512-16	61,20
315	1 1/4"-11,5	51,0	56,0	30,0	50	1350512-20	165,70
315	1 1/2"-11,5	53,0	67,0	36,0	65	1350512-24	517,00



BSP - BSP
Schottausführung mit Kontermutter und 60°-Konus

BSP - Male - BSP - Male
Both sides with 60°-Cone and Back Nut

Druck Pressure PN	Gewinde Thread G	Ca. Maße Approx. Dimensions						Bestellzeichen Order-Code	Brutto-Preis Gross-Price Euro (€)
		L	L1	L2	D	SW1	SW2		
400	1/8"-28	42,5	8	28	4,5	14	14	1050511-02	14,95
400	1/4"-19	46,0	11	28	6,0	19	19	1050511-04	12,85
400	3/8"-19	52,0	12	32	8,0	22	22	1050511-06	14,55
400	1/2"-14	59,0	14	35	11,0	27	27	1050511-08	17,20
400	5/8"-14	63,0	16	35	14,5	30	30	1050511-10	27,75
400	3/4"-14	66,0	16	38	16,5	32	32	1050511-12	27,75
400	1"-11	72,0	19	41	22,5	41	41	1050511-16	39,90
200	1 1/4"-11	78,0	20	44	30,5	50	50	1050511-20	67,35
200	1 1/2"-11	84,0	22	48	37,0	55	55	1050511-24	81,00
100	2"-11	91,0	23	48	46,0	70	70	1050511-32	150,25

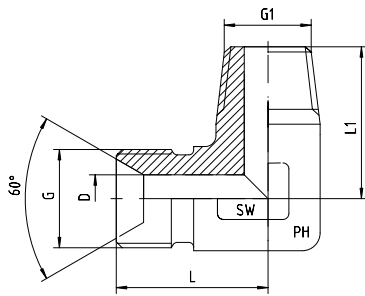

BSP - Zylindrisch - Männlich mit 60°-Konus
BSP - Kegelig - Männlich

BSP - Male with 60°-Cone
BSP - Taper - Male

Druck Pressure PN	Gewinde Thread		Ca. Maße Approx. Dimensions				Bestellzeichen Order-Code	Brutto-Preis Gross-Price Euro (€)
	G = BSP zyl.	G1 = keg.	L	L1	D	SW		
400	1/8"-28	1/8"-28	20,0	20,0	4,0	12	1350500-02	10,00
400	1/4"-19	1/4"-19	24,5	26,0	6,0	14	1350500-04	12,25
400	3/8"-19	3/8"-19	25,5	25,5	8,0	17	1350500-06	16,25
400	1/2"-14	1/2"-14	29,5	35,0	11,0	19	1350500-08	23,75
400	3/4"-14	3/4"-14	37,0	37,0	16,0	27	1350500-12	40,10
400	1"-11	1"-11	43,0	43,0	22,0	36	1350500-16	46,75
200	1 1/4"-11	1 1/4"-11	51,0	51,0	28,5	41	1350500-20	89,00
200	1 1/2"-11	1 1/2"-11	59,0	63,0	33,5	50	1350500-24	165,00
100	2"-11	2"-11	77,5	77,5	45,0	65	1350500-32	429,00

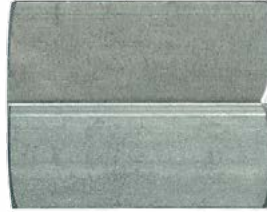
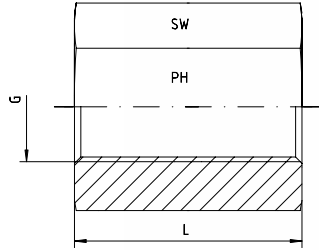

Für Hochdruck
Gewinde: BSP - Zylindrisch

For High Pressure
Thread: BSP - Parallel

Druck Pressure PN	Gewinde Thread G	Ca. Maße Approx. Dimensions		Bestellzeichen Order-Code	Brutto-Preis Gross-Price Euro (€)
		L	SW		
630	1/8"-28	18	14	1050512-02-02	5,65
630	1/4"-19	25	17	1050512-04-04	5,65
630	3/8"-19	26	22	1050512-06-06	8,10
400	1/2"-14	34	27	1050512-08-08	10,45
400	3/4"-14	36	32	1050512-12-12	14,00
400	1"-11	43	41	1050512-16-16	22,50
315	1 1/4"-11	48	50	1050512-20-20	32,45
315	1 1/2"-11	48	55	1050512-24-24	38,25
250	2"-11	56	70	1050512-32-32	69,90

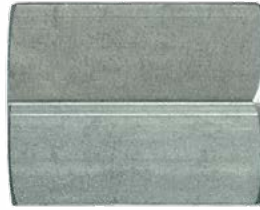
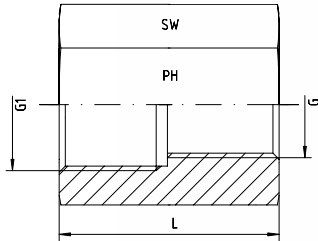

Für Hochdruck
Gewinde: BSP - Zylindrisch - Reduziert

For High Pressure
Thread: BSP - Parallel - Reduced

Druck Pressure PN	Gewinde Thread G1 x G	Ca. Maße Approx. Dimensions		Bestellzeichen Order-Code	Brutto-Preis Gross-Price Euro (€)
		L	SW		
630	1/4" x 1/8"	25	17	1050512-04-02	7,25
630	3/8" x 1/4"	32	22	1050512-06-04	9,95
400	1/2" x 3/8"	35	27	1050512-08-06	13,00
400	1/2" x 1/4"	35	27	1050512-08-04	14,50
400	3/4" x 1/2"	38	32	1050512-12-08	17,20
400	3/4" x 3/8"	38	32	1050512-12-06	18,90
400	1" x 3/4"	42	41	1050512-16-12	24,50
400	1" x 1/2"	42	41	1050512-16-08	25,50
315	1 1/4" x 1"	48	50	1050512-20-16	36,50
315	1 1/2" x 1 1/4"	48	55	1050512-24-20	41,80
250	2" x 1 1/2"	56	70	1050512-32-24	79,75

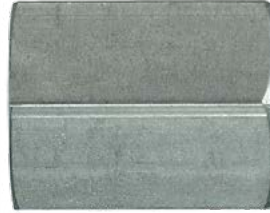
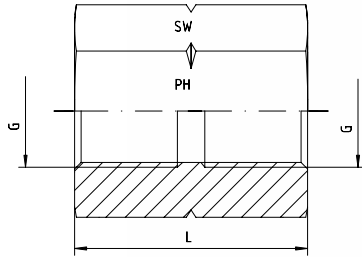

Für Hochdruck
NPT-Innengewinde

For High Pressure
NPT-Internal Thread

Druck Pressure PN	Gewinde Thread G = NPT	Ca. Maße Approx. Dimensions		Bestellzeichen Order-Code	Brutto-Preis Gross-Price Euro (€)
		L	SW		
630	1/8"-27	18	14	1050516-02	9,20
630	1/4"-18	25	17	1050516-04	9,90
630	3/8"-18	26	22	1050516-06	10,60
630	1/2"-14	34	27	1050516-08	13,90
400	3/4"-14	36	32	1050516-12	16,90
400	1"-11,5	43	41	1050516-16	24,90
400	1 1/4"-11,5	59	50	1050516-20	45,90
400	1 1/2"-11,5	59	55	1050516-24	75,90
315	2"-11,5	59	70	1050516-32	138,00

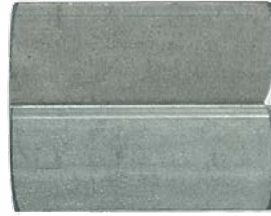
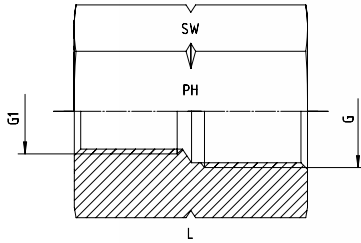

Für Hochdruck
NPT-Innengewinde - Reduziert

For High Pressure
NPT-Internal Thread - Reduced

Druck Pressure PN	Gewinde Thread		Ca. Maße Approx. Dimensions		Bestellzeichen Order-Code	Brutto-Preis Gross-Price Euro (€)
	G = NPT	G1 = NPT	L	SW		
400	3/4"-14	1/2"-14	36,0	32	1050516-12-08	49,00

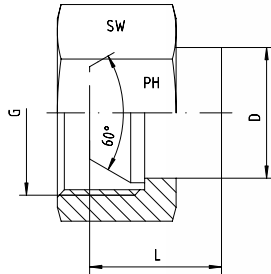

Für BSP-Gewinde mit 60°-Innenkonus
Verschluss - DKR

For BSP-Thread with 60°-Cone

Druck Pressure PN	Gewinde Thread G = BSP	Ca. Maße Approx. Dimensions			Bestellzeichen Order-Code	Brutto-Preis Gross-Price Euro (€)
		L	D	SW		
400	1/8"-28	11	12,0	14	1050513-02	7,00
400	1/4"-19	15	9,0	17	1050513-04	6,15
400	3/8"-19	15	12,4	19	1050513-06	7,00
400	1/2"-14	17	16,4	27	1050513-08	8,35
400	5/8"-14	16	22,0	27	1050513-10	14,50
400	3/4"-14	19	21,3	32	1050513-12	13,00
400	1"-11	20	27,8	41	1050513-16	20,20
200	1 1/4"-11	22	36,0	50	1050513-20	32,35
200	1 1/2"-11	25	45,0	55	1050513-24	52,55
100	2"-11	31	54,5	70	1050513-32	88,70

VERSCHLUSSTOPFEN - BSP

BSP-60°-CONED PLUG

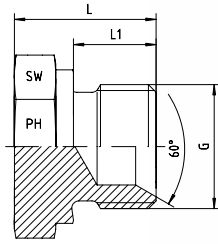

Mit Außen-Sechskant
60°-Innenkonus und angedrehter Dichtkante Form B

With Hexagon
60°-Cone and Sealing Shoulder Form B

Druck Pressure PN	Gewinde Thread G = BSP	Ca. Maße Approx. Dimensions			Bestellzeichen Order-Code	Brutto-Preis Gross-Price Euro (€)
		L	L1	SW		
400	1/8"-28	14,0	8	14	1050514-02	4,05
400	1/4"-19	17,0	10	19	1050514-04	4,05
400	3/8"-19	20,5	12	22	1050514-06	5,15
400	1/2"-14	24,0	14	27	1050514-08	6,50
400	5/8"-14	24,0	14	30	1050514-10	15,50
400	3/4"-14	27,0	16	32	1050514-12	8,50
400	1"-11	31,0	18	41	1050514-16	12,70
200	1 1/4"-11	33,0	20	50	1050514-20	23,30
200	1 1/2"-11	36,0	22	55	1050514-24	35,30
100	2"-11	36,0	22	70	1050514-32	43,00

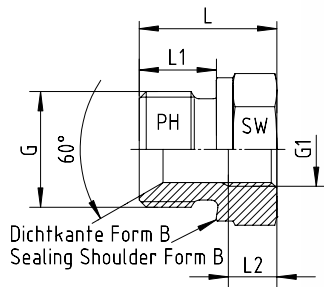

Form A

Mit 60°-Konus am Außengewinde

Beide Gewinde: Whitworth-Rohrgewinde - Zylindrisch -
DIN / ISO 228
Abdichtung durch Dichtkante Form B

With 60°-Cone at Male Thread

Both Threads BSP - Parallel - DIN / ISO 228
Sealing by Sealing Shoulder Form B

Druck Pressure PN	Gewinde Thread		Ca. Maße Approx. Dimensions				Form Form	Bestellzeichen Order-Code	Brutto-Preis Gross-Price Euro (€)
	G = BSP	G1 = BSP	L	L1	L2	SW			
400	3/8"-19	1/8"-28	22,5	12,0	8,0	22	A	1050515-06-02	12,58
400	1/2"-14	1/8"-28	24,0	14,0	8,0	27	A	1050515-08-02	13,93
400	1/2"-14	1/4"-19	24,0	14,0	12,0	27	A	1050515-08-04	13,70
400	3/4"-14	1/8"-28	26,0	16,0	8,0	32	A	1050515-12-02	21,95
400	3/4"-14	1/4"-19	26,0	16,0	12,0	32	A	1050515-12-04	20,96
400	3/4"-14	3/8"-19	26,0	16,0	13,0	32	A	1050515-12-06	20,96
400	1"-11	1/4"-19	29,0	18,0	12,0	41	A	1050515-16-04	25,85
400	1"-11	3/8"-19	29,0	18,0	12,0	41	A	1050515-16-06	26,28
400	1"-11	1/2"-14	29,0	18,0	14,0	41	A	1050515-16-08	28,12
250	1 1/4"-11	3/8"-19	32,0	20,0	17,0	50	A	1050515-20-06	52,80
250	1 1/4"-11	1/2"-14	32,0	20,0	14,0	50	A	1050515-20-08	51,64
250	1 1/4"-11	3/4"-14	32,0	20,0	16,0	50	A	1050515-20-12	52,41
250	1 1/2"-11	1/2"-14	36,0	22,0	14,0	55	A	1050515-24-08	57,27
250	1 1/2"-11	3/4"-14	36,0	22,0	16,0	55	A	1050515-24-12	58,29
250	1 1/2"-11	1"-11	36,0	22,0	18,0	55	A	1050515-24-16	60,33
250	2"-11	1/2"-14	41,5	22,5	16,0	70	A	1050515-32-08	130,38
250	2"-11	3/4"-14	42,0	22,5	16,0	70	A	1050515-32-12	130,38
250	2"-11	1"-11	42,0	22,5	18,5	70	A	1050515-32-16	125,27
250	2"-11	1 1/4"-11	42,0	22,5	18,5	70	A	1050515-32-20	125,27
250	2"-11	1 1/2"-11	42,0	22,5	18,5	70	A	1050515-32-24	125,27

SECHSKANT-ADAPTER MIT 60°-KONUS

HEXAGON ADAPTORS WITH 60°-CONE

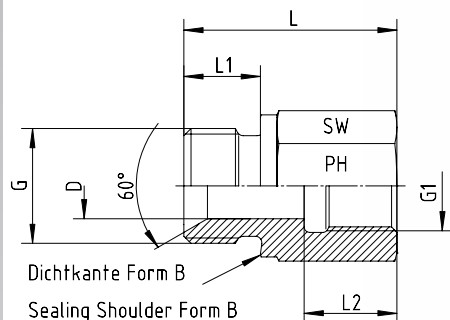

Form B

Mit 60°-Konus am Außengewinde

Beide Gewinde: Whitworth-Rohrgewinde - Zylindrisch - DIN / ISO 228
Abdichtung durch Dichtkante Form B

With 60°-Cone at Male Thread

Both Threads BSP - Parallel - DIN / ISO 228
Sealing by Sealing Shoulder Form B

Druck Pressure PN	Gewinde Thread		Ca. Maße Approx. Dimensions					Form Form	Bestellzeichen Order-Code	Brutto-Preis Gross-Price Euro (€)
	G = BSP	G1 = BSP	L	L1	L2	D	SW			
630	1/8"-28	1/8"-28	23,5	8,0	11,0	4,5	17	B	1050515-02-02	11,85
630	1/8"-28	1/4"-19	31,0	8,0	17,0	4,0	19	B	1050515-02-04	10,84
630	1/8"-28	3/8"-19	32,0	8,0	17,0	4,0	24	B	1050515-02-06	12,78
630	1/8"-28	1/2"-14	37,0	8,0	20,0	4,0	27	B	1050515-02-08	15,88
630	1/4"-19	1/8"-28	28,0	12,0	12,0	7,0	19	B	1050515-04-02	11,15
630	1/4"-19	1/4"-19	32,0	10,0	17,0	6,0	19	B	1050515-04-04	10,85
630	1/4"-19	3/8"-19	36,0	12,0	17,0	7,0	24	B	1050515-04-06	14,57
630	1/4"-19	1/2"-14	40,0	12,0	20,0	5,0	27	B	1050515-04-08	15,88
630	1/4"-19	3/4"-14	43,0	12,0	22,0	6,0	36	B	1050515-04-12	26,69
400	3/8"-19	1/4"-19	36,0	12,0	17,0	8,0	22	B	1050515-06-04	13,81
400	3/8"-19	3/8"-19	36,0	12,0	17,0	9,0	24	B	1050515-06-06	9,20
400	3/8"-19	1/2"-14	41,0	12,0	20,0	8,0	27	B	1050515-06-08	15,85
400	3/8"-19	3/4"-14	44,0	12,0	22,0	8,0	36	B	1050515-06-12	24,29
400	3/8"-19	1"-11	46,5	12,0	24,5	8,0	41	B	1050515-06-16	31,70
400	1/2"-14	3/8"-19	36,0	14,0	17,0	12,0	27	B	1050515-08-06	16,11
400	1/2"-14	1/2"-14	39,0	14,0	20,0	12,0	27	B	1050515-08-08	11,15
400	1/2"-14	3/4"-14	46,0	14,0	22,0	12,0	36	B	1050515-08-12	23,26
400	1/2"-14	1"-11	49,0	14,0	24,5	12,0	41	B	1050515-08-16	31,70
250	1/2"-14	1 1/4"-11	53,0	14,0	26,5	12,0	55	B	1050515-08-20	98,17
400	3/4"-14	1/2"-14	41,0	16,0	20,0	16,0	32	B	1050515-12-08	26,59
400	3/4"-14	3/4"-14	45,0	16,0	22,5	18,0	32	B	1050515-12-12	16,50
400	3/4"-14	1"-11	51,0	16,0	24,5	16,0	41	B	1050515-12-16	35,74
250	3/4"-14	1 1/4"-11	55,0	16,0	26,5	16,0	55	B	1050515-12-20	97,15
250	3/4"-14	1 1/2"-11	57,0	16,0	28,5	16,0	60	B	1050515-12-24	120,67
400	1"-11	3/4"-14	47,0	18,0	22,0	20,0	41	B	1050515-16-12	33,23
400	1"-11	1"-11	49,5	18,0	24,5	22,0	41	B	1050515-16-16	24,35
250	1"-11	1 1/4"-11	57,0	18,0	26,5	20,0	55	B	1050515-16-20	95,51
250	1"-11	1 1/2"-11	59,0	18,0	28,5	20,0	60	B	1050515-16-24	117,60
250	1 1/4"-11	1"-11	52,0	20,0	24,5	25,0	50	B	1050515-20-16	60,84
250	1 1/4"-11	1 1/4"-11	58,0	20,0	27,0	25,0	50	B	1050515-20-20	47,90
250	1 1/4"-11	1 1/2"-11	60,0	20,0	28,5	25,0	60	B	1050515-20-24	116,83
250	1 1/2"-11	1 1/4"-11	58,0	22,0	26,5	32,0	55	B	1050515-24-20	91,37
250	1 1/2"-11	1 1/2"-11	58,0	22,0	27,5	37,0	55	B	1050515-24-24	61,50
100	2"-11	2"-11	64,5	23,0	30,5	43,0	70	B	1050515-32-32	90,00

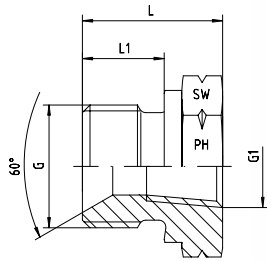

Form A

BSP-Außengewinde mit 60°-Konus
NPT-Innengewinde

BSP - Male with 60°-Cone
NPT - Female

Druck Pressure PN	Gewinde Thread		Ca. Maße Approx. Dimensions				Form Form	Bestellzeichen Order-Code	Brutto-Preis Gross-Price Euro (€)
	G = BSP	G1 = NPT	L	L1	D	SW			
400	1/2"-14	1/4"-18	24,0	14	11,5	27	A	1050518-08-04	12,05
400	1/2"-14	3/8"-18	32,5	14	12,0	27	A	1050518-08-06	12,70
400	3/4"-14	3/8"-18	30,0	16	14,5	32	A	1050518-12-06	22,10
400	1"-11	1/2"-14	31,0	18	18,0	41	A	1050518-16-08	23,60
400	1"-11	3/4"-14	32,0	18	23,0	41	A	1050518-16-12	23,60
200	1 1/4"-11	3/4"-14	37,0	20	22,5	50	A	1050518-20-12	39,95
200	1 1/4"-11	1"-11,5	37,0	20	33,0	50	A	1050518-20-16	39,95
200	1 1/2"-11	1"-11,5	39,0	22	28,5	55	A	1050518-24-16	53,95
200	1 1/2"-11	1 1/4"-11,5	39,0	22	37,0	55	A	1050518-24-20	53,95

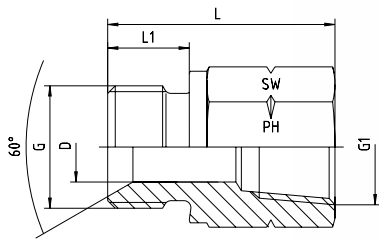

Form B

BSP-Außengewinde mit 60°-Konus
NPT-Innengewinde

*BSP - Male with 60°-Cone
NPT - Female*

Druck Pressure PN	Gewinde Thread		Ca. Maße Approx. Dimensions				Form Form	Bestellzeichen Order-Code	Brutto-Preis Gross-Price Euro (€)
	G = BSP	G1 = NPT	L	L1	D	SW			
400	1/8"-28	1/8"-27	25,0	8	4,0	14	B	1050518-02-02	9,80
400	1/8"-28	1/4"-18	31,0	8	4,0	19	B	1050518-02-04	9,80
400	1/4"-19	1/8"-27	32,0	12	6,0	19	B	1050518-04-02	9,80
400	1/4"-19	1/4"-18	32,0	12	6,0	19	B	1050518-04-04	9,80
400	1/4"-19	3/8"-18	31,0	10	7,0	24	B	1050518-04-06	9,80
400	1/4"-19	1/2"-14	38,0	10	7,0	27	B	1050518-04-08	13,15
400	3/8"-19	1/4"-18	36,0	12	9,0	22	B	1050518-06-04	9,85
400	3/8"-19	3/8"-18	36,0	12	9,0	24	B	1050518-06-06	12,05
400	3/8"-19	1/2"-14	37,0	12	9,0	27	B	1050518-06-08	12,30
400	1/2"-14	1/2"-14	39,0	14	12,0	27	B	1050518-08-08	12,70
400	1/2"-14	3/4"-14	46,0	14	13,0	36	B	1050518-08-12	22,10
400	3/4"-14	1/2"-14	44,0	16	18,0	32	A	1050518-12-08	22,10
400	3/4"-14	3/4"-14	48,0	16	18,0	36	B	1050518-12-12	22,50
400	3/4"-14	1"-11,5	51,0	16	18,0	41	B	1050518-12-16	27,20
400	1"-11	1"-11,5	49,5	18	22,0	41	B	1050518-16-16	27,20
400	1"-11	1 1/4"-11,5	50,5	18	22,0	50	B	1050518-16-20	58,80
200	1 1/4"-11	1 1/4"-11,5	58,0	20	25,0	50	B	1050518-20-20	50,90
200	1 1/2"-11	1 1/2"-11,5	62,0	22	37,0	55	B	1050518-24-24	59,90
100	2"-11	2"-11,5	64,0	23	43,0	70	B	1050518-32-32	109,00

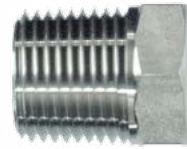
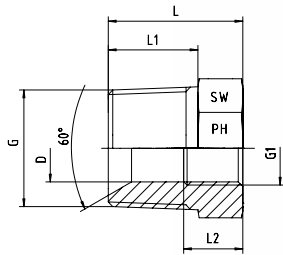

Form A

NPT-Außengewinde mit 60°-Konus
 BSP-Innengewinde

NPT - Male with 60°-Cone
BSP - Female

Druck Pressure PN	Gewinde Thread		Ca. Maße Approx. Dimensions					Form Form	Bestellzeichen Order-Code	Brutto-Preis Gross-Price Euro (€)
	G = NPT	G1 = BSP	L	L1	L2	D	SW			
400	1/2"-14	1/8"-28	26,0	20,0	11,0	8,5	22	A	1050517-08-02	12,05
400	1/2"-14	1/4"-19	27,0	20,0	17,0	13,0	24	A	1050517-08-04	12,05
400	3/4"-14	3/8"-19	28,0	20,0	17,0	15,0	27	A	1050517-12-06	22,10
400	1"-11,5	1/2"-14	34,0	25,0	20,0	19,0	36	A	1050517-16-08	23,60
200	1 1/4"-11,5	3/4"-14	40,0	25,5	22,5	24,2	46	A	1050517-20-12	38,00
200	1 1/4"-11,5	1"-11	40,0	25,5	25,0	30,6	46	A	1050517-20-16	38,00
200	1 1/2"-11,5	1"-11	40,0	26,0	25,0	30,6	55	A	1050517-24-16	53,50

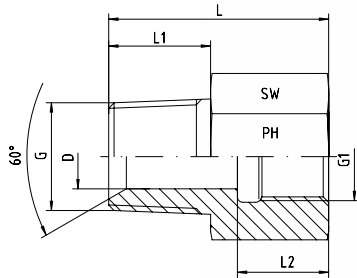

Form B

NPT-Außengewinde mit 60°-Konus
BSP-Innengewinde

NPT - Male with 60°-Cone
BSP - Female

Druck Pressure PN	Gewinde Thread		Ca. Maße Approx. Dimensions					Form Form	Bestellzeichen Order-Code	Brutto-Preis Gross-Price Euro (€)
	G = NPT	G1 = BSP	L	L1	L2	D	SW			
400	1/8"-27	1/8"-28	25,0	10,0	12,0	4,0	14	B	1050517-02-02	9,80
400	1/8"-27	1/4"-19	30,0	10,0	17,0	4,0	19	B	1050517-02-04	9,80
400	1/4"-18	1/8"-28	30,0	15,0	12,0	6,0	14	B	1050517-04-02	9,80
400	1/4"-18	1/4"-19	34,0	15,0	17,0	6,0	19	B	1050517-04-04	9,80
400	1/4"-18	3/8"-19	35,0	15,0	17,0	6,0	24	B	1050517-04-06	9,80
400	1/4"-18	1/2"-14	36,5	15,0	20,0	5,0	27	B	1050517-04-08	12,40
400	3/8"-18	1/4"-19	35,0	15,0	17,0	9,0	19	B	1050517-06-04	9,85
400	3/8"-18	3/8"-19	35,0	15,0	17,0	9,0	24	B	1050517-06-06	12,05
400	3/8"-18	1/2"-14	37,0	15,0	20,0	9,0	27	B	1050517-06-08	12,40
400	1/2"-14	3/8"-19	38,0	20,0	17,0	12,0	24	B	1050517-08-06	12,30
400	1/2"-14	1/2"-14	41,0	20,0	20,0	12,0	27	B	1050517-08-08	12,70
400	1/2"-14	3/4"-14	48,0	20,0	22,5	12,0	32	B	1050517-08-12	22,10
400	3/4"-14	1/2"-14	42,0	20,0	20,0	15,0	27	B	1050517-12-08	19,30
400	3/4"-14	3/4"-14	48,0	20,0	22,5	18,0	32	B	1050517-12-12	22,10
400	3/4"-14	1"-11	50,0	20,0	25,0	18,0	41	B	1050517-12-16	27,20
400	1"-11,5	3/4"-14	54,0	25,0	22,5	21,0	36	B	1050517-16-12	23,60
400	1"-11,5	1"-11	57,0	25,0	25,0	21,0	41	B	1050517-16-16	27,20
200	1"-11,5	1 1/4"-11	57,0	25,0	27,0	21,0	55	B	1050517-16-20	54,10
200	1 1/4"-11,5	1 1/4"-11	57,5	25,5	27,0	30,0	55	B	1050517-20-20	60,00
200	1 1/4"-11,5	1 1/2"-11	62,5	25,5	27,5	30,0	55	B	1050517-20-24	64,00
200	1 1/2"-11,5	1 1/4"-11	56,0	26,0	27,0	36,0	55	B	1050517-24-20	59,50
200	1 1/2"-11,5	1 1/2"-11	63,0	26,0	27,5	36,0	55	B	1050517-24-24	60,20
100	1 1/2"-11,5	2"-11	64,0	26,0	30,5	36,0	70	B	1050517-24-32	125,00
100	2"-11,5	2"-11	64,0	26,0	30,5	46,0	70	B	1050517-32-32	125,00

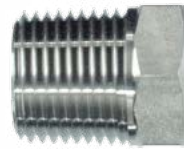
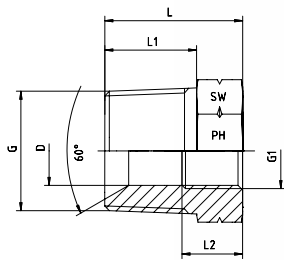

Form A

NPT-Außengewinde mit 60°-Konus
NPT-Innengewinde

NPT - Male with 60°-Cone
NPT - Female

Druck Pressure PN	Gewinde Thread		Ca. Maße Approx. Dimensions				Form Form	Bestellzeichen Order-Code	Brutto-Preis Gross-Price Euro (€)
	G = NPT	G1 = NPT	L	L1	D	SW			
630	3/8"-18	1/8"-27	23,0	15,3	8,5	19	A	1050525-06-02	12,50
630	1/2"-14	1/8"-27	27,0	20,0	8,5	24	A	1050525-08-02	15,10
630	1/2"-14	1/4"-18	27,0	20,0	11,0	24	A	1050525-08-04	15,10
630	3/4"-14	1/4"-18	28,0	20,0	11,0	27	A	1050525-12-04	27,65
630	3/4"-14	3/8"-18	28,0	20,0	14,0	27	A	1050525-12-06	27,65
400	1"-11,5	3/8"-18	34,0	25,0	14,0	36	A	1050525-16-06	29,50
400	1"-11,5	1/2"-14	34,0	25,0	17,7	36	A	1050525-16-08	29,50
400	1 1/4"-11,5	3/4"-14	39,5	25,5	23,0	46	A	1050525-20-12	47,50
400	1 1/2"-11,5	3/4"-14	40,0	26,0	22,5	50	A	1050525-24-12	49,90
400	1 1/2"-11,5	1"-11,5	40,0	26,0	28,5	50	A	1050525-24-16	49,90
315	2"-11,5	1"-11,5	40,0	26,0	28,5	65	A	1050525-32-16	75,00
315	2"-11,5	1 1/2"-11,5	40,0	26,0	43,2	65	A	1050525-32-24	98,00

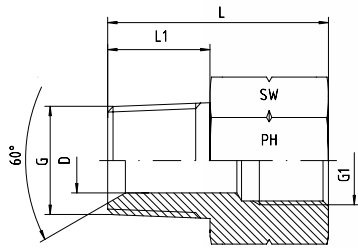

Form B

NPT-Außengewinde mit 60°-Konus
NPT-Innengewinde

NPT - Male with 60°-Cone
NPT - Female

Druck Pressure PN	Gewinde Thread		Ca. Maße Approx. Dimensions				Form Form	Bestellzeichen Order-Code	Brutto-Preis Gross-Price Euro (€)
	G = NPT	G1 = NPT	L	L1	D	SW			
630	1/8"-27	1/8"-27	25,0	10,0	4,0	14	B	1050525-02-02	12,30
630	1/8"-27	1/4"-18	31,0	10,0	4,0	19	B	1050525-02-04	12,30
630	1/4"-18	1/8"-27	30,0	15,0	6,0	14	B	1050525-04-02	12,30
630	1/4"-18	1/4"-18	36,0	15,0	6,0	19	B	1050525-04-04	12,30
630	1/4"-18	3/8"-18	37,0	15,0	6,0	24	B	1050525-04-06	13,10
630	1/4"-18	1/2"-14	42,0	15,0	6,0	27	B	1050525-04-08	15,50
630	3/8"-18	1/4"-18	36,0	15,0	9,0	19	B	1050525-06-04	12,50
630	3/8"-18	3/8"-18	37,0	15,0	9,0	24	B	1050525-06-06	15,10
630	3/8"-18	1/2"-14	41,0	15,0	9,0	27	B	1050525-06-08	15,50
630	1/2"-14	3/8"-18	39,5	20,0	12,0	24	B	1050525-08-06	15,50
630	1/2"-14	1/2"-14	46,0	20,0	12,0	27	B	1050525-08-08	15,90
630	1/2"-14	3/4"-14	48,0	20,0	12,0	36	B	1050525-08-12	27,65
630	3/4"-14	1/2"-14	42,0	20,0	15,0	27	B	1050525-12-08	24,20
630	3/4"-14	3/4"-14	48,0	20,0	18,0	36	B	1050525-12-12	27,65
400	3/4"-14	1"-11,5	50,0	20,0	18,0	36	B	1050525-12-16	35,00
400	1"-11,5	3/4"-14	34,0	25,0	22,6	36	B	1050525-16-12	32,50
400	1"-11,5	1"-11,5	57,0	25,0	21,0	41	B	1050525-16-16	35,00
400	1"-11,5	1 1/4"-11,5	57,0	25,0	21,0	50	B	1050525-16-20	77,00
400	1 1/4"-11,5	1"-11,5	54,0	25,5	28,5	46	B	1050525-20-16	47,50
400	1 1/4"-11,5	1 1/4"-11,5	55,0	25,5	30,0	50	B	1050525-20-20	74,00
400	1 1/4"-11,5	1 1/2"-11,5					B	1050525-20-24	*
400	1 1/2"-11,5	1 1/4"-11,5	55,0	26,0	36,0	50	B	1050525-24-20	79,80
400	1 1/2"-11,5	1 1/2"-11,5	63,0	26,0	36,0	55	B	1050525-24-24	79,80
315	1 1/2"-11,5	2"-11,5					B	1050525-24-32	*

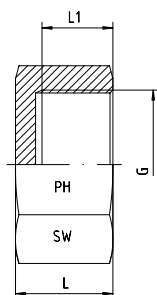

Mit BSP-Innengewinde

With BSP-Thread Female

Druck Pressure PN	Gewinde Thread G = BSP	Ca. Maße Approx. Dimensions			Bestellzeichen Order-Code	Brutto-Preis Gross-Price Euro (€)
		L	L1	SW		
400	1/8"-28	15,0	10,0	14	1050519-02	8,50
400	1/4"-19	18,0	12,5	17	1050519-04	7,15
400	3/8"-19	19,0	13,0	22	1050519-06	9,20
400	1/2"-14	21,0	14,5	27	1050519-08	10,70
400	5/8"-14	21,0	17,5	30	1050519-10	12,20
400	3/4"-14	24,5	18,5	32	1050519-12	12,20
400	1"-11	25,0	19,0	41	1050519-16	17,30
200	1 1/4"-11	29,0	22,0	50	1050519-20	24,70
200	1 1/2"-11	31,0	23,5	55	1050519-24	36,60
100	2"-11	32,0	24,5	70	1050519-32	44,75

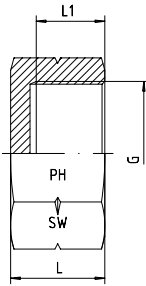

Mit NPT-Innengewinde

With NPT-Thread - Female

Druck Pressure PN	Gewinde Thread G = NPT	Ca. Maße Approx. Dimensions			Bestellzeichen Order-Code	Brutto-Preis Gross-Price Euro (€)
		L	L1	SW		
630	1/8"-27	15,5	10,0	14	1050520-02	10,50
630	1/4"-18	21,5	17,5	17	1050520-04	10,50
630	3/8"-18	22,0	17,5	22	1050520-06	12,50
630	1/2"-14	27,0	23,0	27	1050520-08	14,80
630	3/4"-14	27,0	23,0	32	1050520-12	16,40
400	1"-11,5	32,0	28,0	41	1050520-16	22,90
400	1 1/4"-11,5	36,0	29,0	50	1050520-20	37,50
400	1 1/2"-11,5	36,0	29,0	55	1050520-24	47,60
315	2"-11,5	36,0	29,0	70	1050520-32	74,00

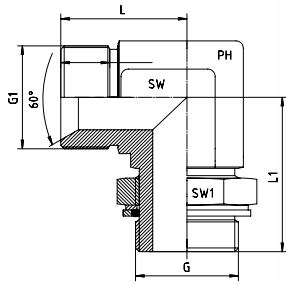

Einstellbare Winkel-Verschraubungen - 90°
BSP - Männlich mit 60°-Konus
Einschraubgewinde: G: Whitworth-Rohrgewinde -
Zylindrisch
Abdichtung durch gekammerten O-Ring Viton

*Adjustable Stud Elbows - 90°
BSP - Male with 60°-Cone
Thread: BSP - Parallel
Sealing by Captive O-ring - Viton and Washer*

Druck Pressure PN	Gewinde Thread		Ca. Maße Approx. Dimensions				Bestellzeichen Order-Code G1 x G	Brutto-Preis Gross-Price Euro (€)
	G1 = BSP	G = BSP	L	L1	SW	SW1		
400	1/4"-19	1/4"-19	27	31,5	14	19	1350501-04-04	18,80
400	3/8"-19	3/8"-19	29	37,0	19	22	1350501-06-06	25,00
400	3/8"-19	1/2"-14	32	43,0	22	27	1350501-06-08	29,70
400	1/2"-14	3/8"-19	34	40,0	22	22	1350501-08-06	27,00
400	1/2"-14	1/2"-14	34	43,0	22	27	1350501-08-08	29,70
400	3/4"-14	3/4"-14	41	50,0	27	36	1350501-12-12	40,90
400	1"-11	1"-11	46	53,0	33	41	1350501-16-16	55,90

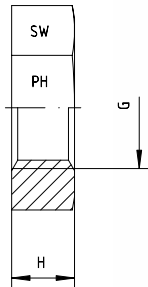

Für Schottverschraubungen
Innengewinde: Whitworth-Rohrgewinde - Zylindrisch

For Bulkhead Couplings
Female Thread: BSP - Parallel

Gewinde Thread G	H	SW	Bestellzeichen Order-Code	Brutto-Preis Gross-Price Euro (€)
1/8"-28	6	14	1050526-02	2,70
1/4"-19	6	19	1050526-04	2,77
3/8"-19	6	22	1050526-06	3,75
1/2"-14	6	27	1050526-08	4,10
5/8"-14	7	30	1050526-10	*
3/4"-14	7	32	1050526-12	6,30
1"-11	11	41	1050526-16	8,00
1 1/4"-11	11	50	1050526-20	12,60
1 1/2"-11	9	55	1050526-24	14,30
2"-11	9	70	1050526-32	30,50

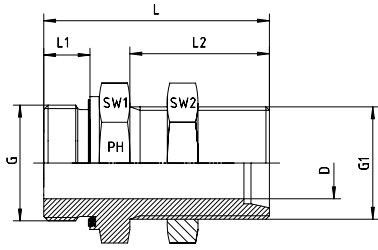

BSP - Metrisch
Schott-Stutzen mit 24°-Konus für Schneidringverschraubung
DIN 2353 / DIN EN ISO 8434-1
mit Kontermutter
Einschraubgewinde: Whitworth-Rohrgewinde - Zylindrisch
Abdichtung durch Profildichtung - Viton

BSP - Metric
Straight Bulkhead connection for Compression Couplings
DIN 2353 / DIN EN ISO 8434-1 with 24°-Cone and backnut
Male-Stub Thread: BSP - Parallel
Sealing by an Elastomer Profiled Ring - Viton

Druck Pressure PN	Rohr A.D. Tube O.D.	Gewinde Thread		Ca. Maße Approx. Dimensions						Bestellzeichen Order-Code	Brutto-Preis Gross-Price Euro (€)
		G = BSP	G1 = Metric	L	L1	L2	D	SW1	SW2		
500	6	1/4"-19	M 12 x 1,5	53,0	12	34	4	19	17	1050509-04-06-L	45,50
500	8	1/4"-19	M 14 x 1,5	53,0	12	34	6	19	19	1050509-04-08-L	45,80
500	10	1/4"-19	M 16 x 1,5	57,0	12	35	7	19	22	1050509-04-10-L	46,50
500	8	3/8"-19	M 14 x 1,5	56,0	12	34	6	22	19	1050509-06-08-L	47,90
500	10	3/8"-19	M 16 x 1,5	55,5	12	35	8	22	22	1050509-06-10-L	48,30
400	12	3/8"-19	M 18 x 1,5	56,5	12	36	10	24	24	1050509-06-12-L	53,60
630	12	3/8"-19	M 20 x 1,5	62,0	12	38	8	27	27	1050509-06-12-S	48,50
400	15	3/8"-19	M 22 x 1,5	58,0	12	38	10	27	30	1050509-06-15-L	57,80
500	10	1/2"-14	M 16 x 1,5	58,0	14	35	8	27	22	1050509-08-10-L	54,90
400	12	1/2"-14	M 18 x 1,5	60,0	14	36	10	27	24	1050509-08-12-L	55,20
630	12	1/2"-14	M 20 x 1,5	63,0	14	38	8	27	27	1050509-08-12-S	56,90
400	15	1/2"-14	M 22 x 1,5	62,0	14	38	12	27	30	1050509-08-15-L	57,80
630	16	1/2"-14	M 24 x 1,5	64,0	14	39	12	27	32	1050509-08-16-S	58,20
400	18	1/2"-14	M 26 x 1,5	63,0	14	40	15	32	36	1050509-08-18-L	59,80
400	15	3/4"-14	M 22 x 1,5	64,0	16	38	12	32	30	1050509-12-15-L	65,50
630	16	3/4"-14	M 24 x 1,5	69,0	16	40	12	32	32	1050509-12-16-S	65,50
400	18	3/4"-14	M 26 x 1,5	66,0	16	40	15	32	36	1050509-12-18-L	65,50
250	22	3/4"-14	M 30 x 2	68,0	16	42	18	36	41	1050509-12-22-L	75,50
400	18	1"-11	M 26 x 1,5	69,0	18	40	15	41	36	1050509-16-18-L	84,30
420	20	1"-11	M 30 x 2	73,0	18	44	16	41	41	1050509-16-20-S	84,30
250	22	1"-11	M 30 x 2	73,0	18	42	19	41	41	1050509-16-22-L	84,30
420	25	1"-11	M 36 x 2	81,5	18	47	19	46	46	1050509-16-25-S	88,90
250	28	1"-11	M 36 x 2	72,0	18	43	24	41	46	1050509-16-28-L	88,00
420	30	1 1/4"-11	M 42 x 2	88,0	20	51	25	50	50	1050509-20-30-S	245,00
250	42	1 1/2"-11	M 52 x 2	86,0	22	47	36	60	65	1050509-24-42-L	259,00





EDELSTAHL / STAINLESS STEEL
VERBINDUNGSTECHNIK
FLUID CONNECTORS

Bördelanschlüsse und Adapter 37° Flare Couplings and Adaptors 37°











6





BÖRDELANSCHLÜSSE / ADAPTER 37° - DIN EN ISO 8434-2 / SAE J 514

FLARE COUPLINGS / ADAPTORS 37° - DIN EN ISO 8434-2 / SAE J 514

	Produktgruppen	Product Groups	Seite Page
	SAE Bördelanschlüsse - Funktion	SAE Flare Couplings - Function	6.3
	Muttern	Nuts	6.4
	Druckringe	Sleeves	6.5
	- Rohr - Metrisch	- Tube - Metric	6.6
	- Rohr - Zöllig	- Tube - Inch	
	JIC-37° - Adapter - Gerade Verbinder	JIC-37° - Adaptors - Straight Unions	6.7
	JIC-37° - Winkel-Adapter - 90°-Winkelverbinder	JIC-37° - Adaptors - 90°-Elbow Connectors	6.8
	JIC-37° - T-Verbinder	JIC-37° - T-Connectors	6.9
	JIC-37° - Adapter - Gerade - JIC - Weiblich x JIC - Weiblich	JIC-37° - Adaptors - Straight - JIC - Female x JIC - Female	6.10
	JIC-37° - Adapter - Gerade - JIC - Männlich x BSP - Männlich - JIC - Männlich - SAE J 514 - JIC - Männlich x NPT - Männlich - JIC - Männlich x Kegelig - Männlich	JIC-37° - Adaptors - Straight - JIC - Male x BSP - Male - JIC - Male - SAE J 514 - JIC - Male x NPT - Male - JIC - Male x Taper - Male	6.11 6.12 6.13 6.14
	JIC-37° - Adapter - Gerade - JIC - Weiblich x BSP - Männlich - JIC - Weiblich x JIC - Männlich - Form A - JIC - Weiblich x JIC - Männlich - Form B	JIC-37° - Adaptors - Straight - JIC - Female x BSP - Male - JIC - Female x JIC - Male - Form A - JIC - Female x JIC - Male - Form B	6.15 6.16 6.17
	JIC-37° - Adapter - Verschlussstopfen - Verschlusskappen	JIC-37° - Adaptors - Coned Plug - Swivel Cap	6.18 6.19
	JIC-37° - Adapter - 90°-Winkel - JIC - Männlich x NPT - Männlich - JIC - Männlich x Kegelig - Männlich	JIC-37° - Adaptors - 90°-Elbow - JIC - Male x NPT - Male - JIC - Male x BSP - Taper - Male	6.20 6.21
	JIC-37° - Verschraubungen - Gerade Schottverschraubungen - Winkel-Schottverschraubungen - 90°	JIC-37° - Connections - Straight Bulkhead Connections - 90°-Elbow Bulkhead Connections	6.22 6.23

Produktgruppen	Product Groups	Seite Page
 <p>Gegenmuttern - Für Schottverschraubungen</p>	<p>Locknuts - For Bulkhead Couplings</p>	6.24
 <p>JIC-37° - Gerade Adapter - JIC - Weiblich x NPT - Männlich</p>	<p>JIC-37° - Straight Adaptors - JIC - Female x NPT - Male</p>	6.25
 <p>JIC-37° - Winkel-Adapter - JIC - Weiblich x NPT - Männlich</p>	<p>JIC-37°- Elbow Adaptors - JIC - Female x NPT - Male</p>	6.26
 <p>JIC-37° - Winkel-Adapter - JIC - Weiblich x JIC - Männlich - 90°</p>	<p>JIC-37°- Elbow Adaptors - JIC - Female x JIC - Male - 90°</p>	6.27
 <p>JIC-37° - Winkel-Adapter - JIC - Weiblich x JIC - Männlich - 45°</p>	<p>JIC-37°- Elbow Adaptors - JIC - Female x JIC - Male - 45°</p>	6.28
 <p>JIC-37° - TEE-Adapter - JIC - Weiblich x JIC - Männlich</p>	<p>JIC-37° - TEE-Adaptors - JIC - Female x JIC - Male</p>	6.29
 <p>JIC-37° - LE-Adapter - JIC - Weiblich x JIC - Männlich</p>	<p>JIC-37° - TEE-Adaptors - JIC - Female x JIC - Male</p>	6.30
 <p>EVW-Verschraubungen - EVW-Verschraubungen - 90° - EVW-Verschraubungen - 90° - EVW-Verschraubungen - 45°</p>	<p>Male Stud Elbows - Male Stud Elbows - 90° - Male Stud Elbows - 90° - Male Stud Elbows - 45°</p>	6.31 6.32 6.33
 <p>37°-Bördel-Manometerverschraubungen</p>	<p>37°-Flare-Gauge Couplings</p>	6.34
 <p>37°-Bördel-Aufschraubverschraubungen</p>	<p>37°-Flare-Female-Stud-Adaptors</p>	6.35

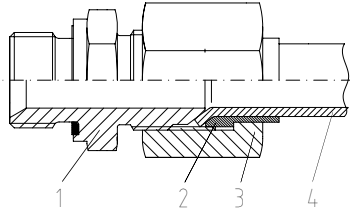

Bördelanschluss 37° nach SAE J 514 und
ISO 8434 Teil 2

Flare Tube 37° to SAE J 514 and ISO 8434 Part 2

Die Bördelverschraubung nach SAE J 514 und ISO 8434-2 besteht aus Verschraubungsstutzen 1, Druckring 2 und Überwurfmutter 3. Durch Austauschen des Druckringes ist die gleiche Verschraubung für metrisches und zölliges Rohr, das unter 37° gebördelt wurde, verwendbar.

Bei der Montage wird das gebördelte Rohr 4 zwischen Druckring und Verschraubungsstutzen eingeklemmt und festgehalten. Der Druckring zentriert und stützt hierbei das Rohr und dient gleichzeitig als Sicherung gegen Verdrehen und Vibration.

Da er sich beim Anziehen der Überwurfmutter nicht mitdreht, werden Spannungen am Rohrsystem vermieden. Die entstandene, rein metallische Dichtung garantiert eine hohe Sicherheit. Auf Anfrage auch mit O-Ring Dichtung am Verschraubungsstutzen 1 lieferbar.

The flare coupling to SAE J 514 and ISO 8434-2 comprises a coupling body 1, pressure ring 2 and securing nut 3.

By exchanging the pressure ring, the same coupling can be used with both metric and inch size pipe flared at less than 37°.

On fitting, the flared tube 4 is wedged and held between the pressure ring and the coupling body. The pressure ring centres and supports the tube at the same time preventing it from twisting and dampening vibration.

As it does not turn with the securing nut, no tension is transmitted to the tube system. The result is an extremely dependable metal seal. On request with o-ring seal on the coupling body 1.

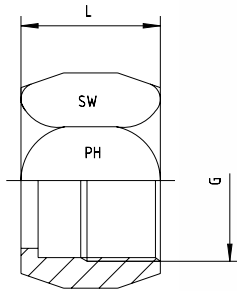

Für 37°-Bördelverschraubungen
Nach SAE J 514 und ISO 8434 Teil 2

For 37°-Flare Couplings
To SAE J 514 and ISO 8434 Part 2

Rohr A.D. Tube O.D.		Gewinde Thread		L	SW	Bestellzeichen Order-Code	Brutto-Preis Gross-Price Euro (€)
mm	in.	G					
6	1/4"	7/16"-20 UNF	15,5	14	M-37-06-04	3,10	
8	5/16"	1/2"-20 UNF	17,0	17	M-37-08-05	3,35	
10	3/8"	9/16"-18 UNF	18,3	19	M-37-10-06	3,50	
12	1/2"	3/4"-16 UNF	21,3	22	M-37-12-08	4,25	
14, 15, 16	5/8"	7/8"-14 UNF	24,6	27	M-37-16-10	5,85	
18, 20	3/4"	1 1/16"-12 UN	25,9	32	M-37-20-12	8,50	
25	1"	1 5/16"-12 UN	28,4	41	M-37-25-16	10,95	
28, 30, 32	1 1/4"	1 5/8"-12 UN	31,0	50	M-37-30-20	18,75	
35, 38	1 1/2"	1 7/8"-12 UN	35,8	60	M-37-38-24	33,15	
50	2"	2 1/2"-12 UN	44,2	75	M-37-50-32	135,00	

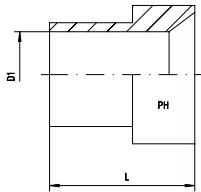

Für 37°-Bördelverschraubungen
Nach SAE J 514 und ISO 8434 Teil 2
Rohr - Metrisch

For 37°-Flare Couplings
To SAE J 514 and ISO 8434 Part 2
Tube - Metric

Rohr A.D. Tube O.D. mm	D1 + Tol.	L	Bestellzeichen Order-Code	Brutto-Preis Gross-Price Euro (€)
6	6	10,4	DR-37-06	1,95
8	8	11,2	DR-37-08	2,20
10	10	12,7	DR-37-10	2,70
12	12	14,2	DR-37-12	3,00
14	14	14,0	DR-37-14	4,50
15	15	14,0	DR-37-15	4,50
16	16	16,8	DR-37-16	4,50
18	30	23,1	DR-37-18	5,50
20	20	17,3	DR-37-20	5,50
25	25	19,8	DR-37-25	9,20
28	28	23,0	DR-37-28	11,10
30	30	23,1	DR-37-30	11,10
32	32	23,0	DR-37-32	11,10
35	35	28,4	DR-37-35	18,65
38	38	28,4	DR-37-38	18,65
50	50	30,2	DR-37-50	32,50

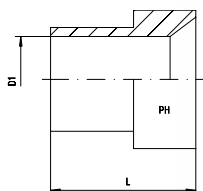

Für 37°-Bördelverschraubungen
Nach SAE J 514 und ISO 8434 Teil 2
Rohr - Zöllig

For 37°-Flare Couplings
To SAE J 514 and ISO 8434 Part 2
Tube - Inch

Rohr A.D. Tube O.D.		D1	L	Bestellzeichen Order-Code	Brutto-Preis Gross-Price Euro (€)
in.	mm				
1/4"	6,35	6,53	10,4	DR-37-1/4"	2,50
5/16"	7,94	8,13	11,2	DR-37-5/16"	2,75
3/8"	9,52	9,73	12,7	DR-37-3/8"	3,25
1/2"	12,70	12,88	14,2	DR-37-1/2"	3,60
5/8"	15,88	16,08	16,8	DR-37-5/8"	3,60
3/4"	19,05	19,28	17,3	DR-37-3/4"	5,50
1"	25,40	25,60	19,8	DR-37-1"	11,50
1 1/4"	31,75	32,05	23,1	DR-37-1 1/4"	15,00
1 1/2"	38,10	38,40	28,4	DR-37-1 1/2"	23,00
2"	50,80	51,21	30,2	DR-37-2"	32,50

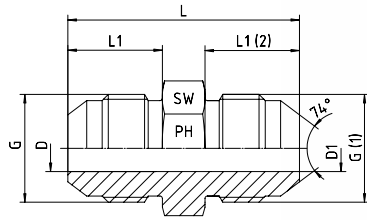

Gerade Verbinder
Männlich - Männlich
Reduzieradapter auf Anfrage!
Zum Beispiel: Rohr 20 auf 16 = Bestellzeichen: 1252510-12-10

Straight Unions
Male - Male
Reducers on request!
For Example: Tube 20 to 16 = Order-Code: 1252510-12-10

Druck Pressure PN	Rohr A.D. Tube O.D.		Gewinde Thread		Ca. Maße Approx. Dimensions					Bestellzeichen Order-Code	Brutto-Preis Gross-Price Euro (€)	
	mm	in.	G	G1	L	L1	L2	D	D1			SW
350	6	1/4"	7/16"-20 UNF		35,0	14,0				12	1252510-04-04	5,80
350	8	5/16"	1/2"-20 UNF		35,0	14,0				14	1252510-05-05	5,80
350			9/16"-18 UNF	7/16"-20 UNF	35,0	14,1	14,0	7,5	4,0	17	1252510-06-04	9,37
350	10	3/8"	9/16"-18 UNF		36,0	14,1		7,5		17	1252510-06-06	6,25
350			3/4"-16 UNF	9/16"-18 UNF	38,1	16,7	14,1	9,5	7,5	22	1252510-08-06	11,17
350	12	1/2"	3/4"-16 UNF		41,0	16,7		9,5		22	1252510-08-08	7,45
350			7/8"-14 UNF	3/4"-16 UNF	45,0	19,3	16,7	12,5	9,5	24	1252510-10-08	14,95
350	14, 15, 16	5/8"	7/8"-14 UNF		48,0	19,3		12,5		24	1252510-10-10	10,00
350			1 1/16"-12 UN	3/4"-16 UNF	48,0	21,9	16,7	15,0	9,5	27	1252510-12-08	20,40
350			1 1/16"-12 UN	7/8"-14 UNF	51,0	21,9	19,3	15,0	12,5	27	1252510-12-10	20,40
350	18, 20	3/4"	1 1/16"-12 UN		55,0	21,9		15,0		27	1252510-12-12	13,60
280			1 5/16"-12 UN	1 1/16"-12 UN	56,0	23,1	21,9	21,5	15,0	36	1252510-16-12	17,80
280	25	1"	1 5/16"-12 UN		57,0	23,1		21,5		36	1252510-16-16	15,20
210			1 5/8"-12 UN	1 1/16"-12 UN	56,0	24,3	21,9	27,5	15,0	46	1252510-20-12	71,75
210			1 5/8"-12 UN	1 5/16"-12 UN	57,0	24,3	23,1	27,5	21,5	46	1252510-20-16	56,25
210	28, 30, 32	1 1/4"	1 5/8"-12 UN		61,5	24,3		27,5		46	1252510-20-20	28,55
210			1 7/8"-12 UN	1 5/8"-12 UN	65,0	27,5	24,3	33,0	27,5	50	1252510-24-20	58,70
210	35, 38	1 1/2"	1 7/8"-12 UN		70,0	27,5		33,0		50	1252510-24-24	39,15
150	50	2"	2 1/2"-12 UN		80,0	33,9		45,0		65	1252510-32-32	66,60

JIC-37° - WINKEL-ADAPTER JIC-37° - ELBOW-ADAPTORS

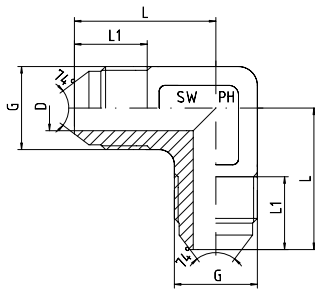

90°-Winkelverbinder
Männlich - Männlich

90°-Elbow Connectors
Male - Male

Druck Pressure PN	Rohr A.D. Tube O.D.		Gewinde Thread G	Ca. Maße Approx. Dimensions				Bestellzeichen Order-Code	Brutto-Preis Gross-Price Euro (€)
	mm	in.		L	L1	D	SW		
350	6	1/4"	7/16"-20 UNF	22,5	14,0	4,5	12	1252511-04-04	14,30
350	8	5/16"	1/2"-20 UNF	24,0	14,0	6,0	13	1252511-05-05	15,20
350	10	3/8"	9/16"-18 UNF	27,0	14,1	7,5	14	1252511-06-06	15,25
350	12	1/2"	3/4"-16 UNF	31,0	16,7	10,0	19	1252511-08-08	19,90
350	14, 15, 16	5/8"	7/8"-14 UNF	37,5	19,3	12,5	24	1252511-10-10	23,10
350	18, 20	3/4"	1 1/16"-12 UN	42,0	21,9	15,0	24	1252511-12-12	30,90
280	25	1"	1 5/16"-12 UN	46,0	23,1	21,5	33	1252511-16-16	42,35
210	28, 30, 32	1 1/4"	1 5/8"-12 UN	52,5	24,3	27,5	41	1252511-20-20	64,05
210	35, 38	1 1/2"	1 7/8"-12 UN	59,0	27,5	33,0	50	1252511-24-24	100,10
150	50	2"	2 1/2"-12 UN	77,5	33,9	45,0	65	1252511-32-32	298,00

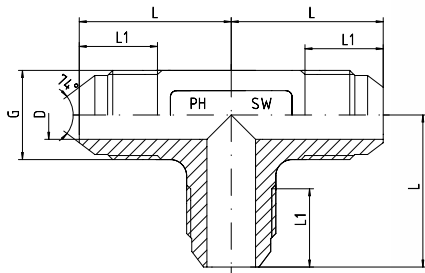

Alle Seiten männlich

All Sides Male

Druck Pressure PN	Rohr A.D. Tube O.D.		Gewinde Thread G	Ca. Maße Approx. Dimensions				Bestellzeichen Order-Code	Brutto-Preis Gross-Price Euro (€)
	mm	in.		L	L1	D	SW		
350	6	1/4"	7/16"-20 UNF	22,5	14,0	4,5	12	1252512-04-04-04	19,95
350	8	5/16"	1/2"-20 UNF	24,0	14,0	6,0	13	1252512-05-05-05	21,95
350	10	3/8"	9/16"-18 UNF	27,0	14,1	7,5	14	1252512-06-06-06	21,95
350	12	1/2"	3/4"-16 UNF	31,0	16,7	10,0	19	1252512-08-08-08	33,75
350	14, 15, 16	5/8"	7/8"-14 UNF	37,5	19,3	12,5	24	1252512-10-10-10	43,50
350	18, 20	3/4"	1 1/16"-12 UN	42,0	21,9	15,5	24	1252512-12-12-12	46,00
280	25	1"	1 5/16"-12 UN	46,0	23,1	21,5	33	1252512-16-16-16	62,50
210	28, 30, 32	1 1/4"	1 5/8"-12 UN	52,5	24,3	27,5	41	1252512-20-20-20	93,20
210	35, 38	1 1/2"	1 7/8"-12 UN	59,0	27,5	33,0	50	1252512-24-24-24	130,00
150	50	2"	2 1/2"-12 UN	77,5	33,9	45,0	65	1252512-32-32-32	398,00

JIC-37° - ADAPTER

JIC-37° - ADAPTORS

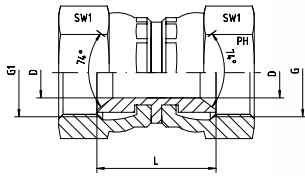

JIC - Weiblich - Drehbar
Beide Seiten

JIC - Female - Swivel
Both Sides

Druck Pressure PN	Rohr A.D. Tube O.D.		Gewinde Thread G1	Ca. Maße Approx. Dimensions			Bestellzeichen Order-Code	Brutto-Preis Gross-Price Euro (€)
	mm	in.		L	D	SW1		
350	6	1/4"	7/16"-20 UNF	21,0	4,0	17	3252511-04-04	9,80
350	8	5/16"	1/2"-20 UNF	21,0	5,0	17	3252511-05-05	9,80
350	10	3/8"	9/16"-18 UNF	24,0	7,0	19	3252511-06-06	12,25
350	12	1/2"	3/4"-16 UNF	25,5	10,0	24	3252511-08-08	14,30
350	14, 15, 16	5/8"	7/8"-14 UNF	30,0	12,0	27	3252511-10-10	20,65
350	18, 20	3/4"	1 1/16"-12 UN	30,0	15,0	32	3252511-12-12	27,70
280	25	1"	1 5/16"-12 UN	35,0	21,0	41	3252511-16-16	42,95
210	28, 30, 32	1 1/4"	1 5/8"-12 UN	35,0	27,5	50	3252511-20-20	71,15
210	35, 38	1 1/2"	1 7/8"-12 UN	40,0	33,0	55	3252511-24-24	96,85

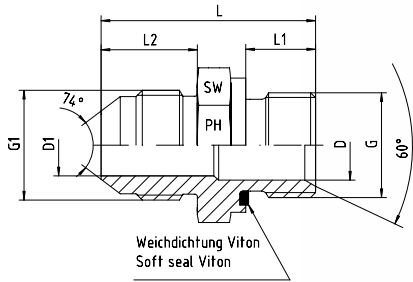

JIC - Männlich
BSP - Männlich
Mit gekammerter Weichdichtung

JIC - Male
BSP - Male
With Captive Soft Seal

Druck Pressure PN	Rohr A.D. Tube O.D.		Gewinde Thread		Ca. Maße Approx. Dimensions						Bestellzeichen Order-Code G1 x G	Brutto-Preis Gross-Price Euro (€)
	mm	in.	G1 = UNF/UN	G = BSP	L	L1	L2	D	D1	SW		
350	6	1/4"	7/16"-20	1/8"-28	30,0	8	14,0	3,5	3,5	14	1052510-04-02	5,16
350	6	1/4"	7/16"-20	1/4"-19	34,0	12	14,0	4,0	4,0	19	1052510-04-04	6,38
350	6	1/4"	7/16"-20	3/8"-19	34,5	12	14,0	8,0	4,0	22	1052510-04-06	11,25
350	6	1/4"	7/16"-20	1/2"-14	37,5	14	14,0	11,5	4,0	27	1052510-04-08	12,95
350	8	5/16"	1/2"-20	1/8"-28	30,0	8	14,0	4,5	4,5	14	1052510-05-02	5,25
350	8	5/16"	1/2"-20	1/4"-19	34,0	12	14,0	5,0	5,0	19	1052510-05-04	6,45
350	8	5/16"	1/2"-20	3/8"-19	34,5	12	14,0	8,0	5,0	22	1052510-05-06	7,20
350	8	5/16"	1/2"-20	1/2"-14	37,5	14	14,0	11,5	5,0	27	1052510-05-08	10,90
350	10	3/8"	9/16"-18	1/8"-28	30,0	8	14,0	4,5	6,0	17	1052510-06-02	6,50
350	10	3/8"	9/16"-18	1/4"-19	33,0	10	14,0	6,0	6,0	19	1052510-06-04	6,50
350	10	3/8"	9/16"-18	3/8"-19	34,5	12	14,0	7,5	7,5	22	1052510-06-06	7,20
350	10	3/8"	9/16"-18	1/2"-14	40,0	14	14,0	12,0	7,5	27	1052510-06-08	10,10
350	12	1/2"	3/4"-16	1/4"-19	37,0	10	17,0	5,0	9,5	22	1052510-08-04	6,60
350	12	1/2"	3/4"-16	3/8"-19	41,0	12	17,0	9,0	9,0	22	1052510-08-06	7,50
350	12	1/2"	3/4"-16	1/2"-14	40,5	14	17,0	9,5	9,5	27	1052510-08-08	8,95
350	12	1/2"	3/4"-16	3/4"-14	46,0	16	17,0	17,0	9,5	32	1052510-08-12	12,90
350	14, 15, 16	5/8"	7/8"-14	3/8"-19	42,5	12	19,5	8,0	12,0	24	1052510-10-06	8,85
350	14, 15, 16	5/8"	7/8"-14	1/2"-14	43,0	14	19,5	12,0	12,0	27	1052510-10-08	9,70
350	14, 15, 16	5/8"	7/8"-14	5/8"-14	44,5	16	19,5	14,5	12,0	30	1052510-10-10	14,00
350	14, 15, 16	5/8"	7/8"-14	3/4"-14	46,0	16	19,5	17,0	12,0	32	1052510-10-12	14,75
350	14, 15, 16	5/8"	7/8"-14	1"-11	50,0	18	19,5	22,5	12,0	41	1052510-10-16	29,50
350	18, 20	3/4"	1 1/16"-12	3/8"-19	44,5	12	22,0	8,0	15,0	27	1052510-12-06	12,05
350	18, 20	3/4"	1 1/16"-12	1/2"-14	50,0	14	22,0	11,5	15,0	27	1052510-12-08	12,05
350	18, 20	3/4"	1 1/16"-12	3/4"-14	51,0	16	22,0	15,0	15,0	32	1052510-12-12	12,75
350	18, 20	3/4"	1 1/16"-12	1"-11	53,0	18	22,0	22,5	15,0	41	1052510-12-16	28,40
350	18, 20	3/4"	1 1/16"-12	1 1/4"-11	56,5	20	22,0	29,0	15,0	50	1052510-12-20	45,50
280	25	1"	1 5/16"-12	1/2"-14	51,0	14	23,0	11,5	21,5	36	1052510-16-08	29,00
280	25	1"	1 5/16"-12	3/4"-14	53,0	16	23,0	17,5	21,5	36	1052510-16-12	22,20
280	25	1"	1 5/16"-12	1"-11	53,5	18	23,0	21,5	21,5	41	1052510-16-16	22,40
280	25	1"	1 5/16"-12	1 1/4"-11	57,5	20	23,0	29,0	21,5	50	1052510-16-20	45,50
210	25	1"	1 5/16"-12	1 1/2"-11	59,5	22	23,0	33,5	21,0	55	1052510-16-24	69,50
210	28, 30, 32	1 1/4"	1 5/8"-12	3/4"-14	56,7	16	24,3	17,0	26,5	46	1052510-20-12	41,25
210	28, 30, 32	1 1/4"	1 5/8"-12	1"-11	55,0	18	24,3	23,0	26,5	46	1052510-20-16	41,25
210	28, 30, 32	1 1/4"	1 5/8"-12	1 1/4"-11	59,0	20	24,3	29,0	26,5	50	1052510-20-20	41,25
210	28, 30, 32	1 1/4"	1 5/8"-12	1 1/2"-11	61,0	22	24,3	33,5	26,5	55	1052510-20-24	62,50
150	28, 30, 32	1 1/4"	1 5/8"-12	2"-11	64,3	25	24,3	46,0	26,5	70	1052510-20-32	148,00
210	35, 38	1 1/2"	1 7/8"-12	1"-11	60,0	18	27,5	22,5	32,0	50	1052510-24-16	52,50
210	35, 38	1 1/2"	1 7/8"-12	1 1/4"-11	62,0	20	27,5	29,0	32,0	50	1052510-24-20	52,50
210	35, 38	1 1/2"	1 7/8"-12	1 1/2"-11	64,0	22	27,5	33,5	32,0	55	1052510-24-24	50,00
150	35, 38	1 1/2"	1 7/8"-12	2"-11	67,5	23	27,5	46,0	32,0	70	1052510-24-32	129,00
150	50	2"	2 1/2"-12	2"-11	76,0	23	33,9	45,0	45,0	70	1052510-32-32	115,00

JIC-37° - ADAPTER

JIC-37° - ADAPTORS

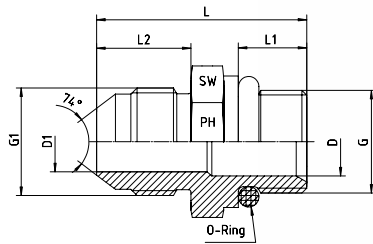

JIC - Männlich

Einschraubgewinde: UNF (ASA B 1.1 - 1960)

Abdichtung durch Runddichtring (O-Ring) - SAE J 514

Achtung: Spezielle Gewindeausenkung erforderlich.

JIC - Male

Thread: UNF (ASA B 1.1 - 1960)

Sealing by O-ring in Thread Undercut - SAE J 514

Note: A special part shape must be machined.

Druck Pressure PN	Rohr A.D. Tube O.D.		Gewinde Thread		Ca. Maße Approx. Dimensions						Bestellzeichen Order-Code G1 x G	Brutto-Preis Gross-Price Euro (€)
	mm	in.	G1 = UNF/UN	G = UNF/UN	L	L1	L2	D	D1	SW		
350	6	1/4"	7/16"-20	7/16"-20	31,0	9,2	14,0	4,5	4,5	17	1052511-04-04	6,38
350	8	5/16"	1/2"-20	1/2"-20	31,0	9,2	14,0	6,0	6,0	17	1052511-05-05	6,38
350	10	3/8"	9/16"-18	9/16"-18	33,0	10,0	14,0	7,5	7,5	19	1052511-06-06	6,50
350	10	3/8"	9/16"-18	3/4"-16	35,5	11,0	14,0	9,5	7,5	24	1052511-06-08	12,00
350	12	1/2"	3/4"-16	3/4"-16	38,0	11,0	17,0	9,5	9,5	24	1052511-08-08	8,95
350	12	1/2"	3/4"-16	7/8"-14	40,0	12,7	17,0	12,0	9,5	27	1052511-08-10	17,00
350	14, 15, 16	5/8"	7/8"-14	3/4"-16	42,0	11,0	19,5	9,5	12,5	27	1052511-10-08	22,00
350	14, 15, 16	5/8"	7/8"-14	7/8"-14	43,0	12,7	19,5	12,0	12,0	27	1052511-10-10	9,70
350	14, 15, 16	5/8"	7/8"-14	1 1/16"-12	47,0	15,0	19,5	15,0	12,0	32	1052511-10-12	22,00
350	18, 20	3/4"	1 1/16"-12	1 1/16"-12	50,0	15,0	22,0	15,0	15,0	32	1052511-12-12	12,75
350	18, 20	3/4"	1 1/16"-12	1 5/16"-12	51,0	15,0	22,0	21,5	15,0	41	1052511-12-16	29,00
280	25	1"	1 5/16"-12	1 5/16"-12	52,0	15,0	23,0	21,5	21,5	41	1052511-16-16	22,40
210	28, 30, 32	1 1/4"	1 5/8"-12	1 5/8"-12	53,0	15,0	24,3	27,5	27,5	50	1052511-20-20	45,50
210	35, 38	1 1/2"	1 7/8"-12	1 7/8"-12	56,5	15,0	27,5	33,0	33,0	55	1052511-24-24	69,95

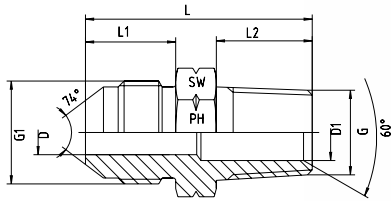

JIC - Männlich
NPT - Männlich

JIC - Male
NPT - Male

Druck Pressure PN	Rohr A.D. Tube O.D.		Gewinde Thread		Ca. Maße Approx. Dimensions						Bestellzeichen Order-Code	Brutto-Preis Gross-Price Euro (€)
	mm	in.	G1 = UNF/UN	G = NPT	L	L1	L2	D	D1	SW		
350	6	1/4"	7/16"-20	1/8"-27	31,0	14,0	10,0	4,0	4,0	12	1252810-04-02	5,30
350	6	1/4"	7/16"-20	1/4"-18	36,0	14,0	15,0	4,0	4,0	17	1252810-04-04	5,30
350	6	1/4"	7/16"-20	3/8"-18	36,0	14,0	15,3	4,0	9,0	19	1252810-04-06	5,70
350	6	1/4"	7/16"-20	1/2"-14	42,0	14,0	20,0	4,0	13,0	22	1252810-04-08	8,65
350	8	5/16"	1/2"-20	1/8"-27	30,0	14,0	10,0	4,0	4,0	14	1252810-05-02	5,35
350	8	5/16"	1/2"-20	1/4"-18	36,0	14,0	15,0	5,0	5,0	17	1252810-05-04	5,35
350	8	5/16"	1/2"-20	3/8"-18	36,0	14,0	15,3	5,0	9,0	19	1252810-05-06	8,50
350	8	5/16"	1/2"-20	1/2"-14	42,0	14,0	20,0	5,0	13,0	22	1252810-05-08	12,00
350	10	3/8"	9/16"-18	1/8"-27	30,0	14,0	10,0	6,0	4,0	17	1252810-06-02	5,78
350	10	3/8"	9/16"-18	1/4"-18	34,0	14,0	15,0	6,0	6,0	17	1252810-06-04	5,78
350	10	3/8"	9/16"-18	3/8"-18	34,0	14,0	15,3	6,0	6,0	19	1252810-06-06	5,78
350	10	3/8"	9/16"-18	1/2"-14	43,0	14,0	20,0	7,5	13,0	22	1252810-06-08	7,50
350	12	1/2"	3/4"-16	1/4"-18	39,0	17,0	15,0	9,0	5,0	19	1252810-08-04	7,20
350	12	1/2"	3/4"-16	3/8"-18	39,0	17,0	15,3	9,0	9,0	19	1252810-08-06	7,20
350	12	1/2"	3/4"-16	1/2"-14	45,7	17,0	20,0	9,5	9,5	22	1252810-08-08	7,85
350	12	1/2"	3/4"-16	3/4"-14	47,2	17,0	20,0	9,5	17,0	27	1252810-08-12	8,95
350	14, 15, 16	5/8"	7/8"-14	3/8"-18	42,0	19,5	15,3	12,0	9,0	24	1252810-10-06	8,65
350	14, 15, 16	5/8"	7/8"-14	1/2"-14	48,0	19,5	20,0	12,0	12,0	24	1252810-10-08	9,40
350	14, 15, 16	5/8"	7/8"-14	3/4"-14	48,2	19,5	20,0	12,0	18,0	27	1252810-10-12	9,90
350	18, 20	3/4"	1 1/16"-12	3/8"-18	47,0	22,0	15,3	15,0	9,0	27	1252810-12-06	36,80
350	18, 20	3/4"	1 1/16"-12	1/2"-14	52,2	22,0	20,0	15,0	13,5	27	1252810-12-08	12,25
350	18, 20	3/4"	1 1/16"-12	3/4"-14	52,3	22,0	20,0	15,0	15,0	27	1252810-12-12	12,25
350	18, 20	3/4"	1 1/16"-12	1"-11,5	57,5	22,0	25,0	15,0	21,0	36	1252810-12-16	25,10
280	25	1"	1 5/16"-12	1/2"-14	53,2	23,0	20,0	21,0	13,5	36	1252810-16-08	25,10
280	25	1"	1 5/16"-12	3/4"-14	53,0	23,0	20,0	21,0	18,0	36	1252810-16-12	18,75
280	25	1"	1 5/16"-12	1"-11,5	58,0	23,0	25,0	21,0	21,0	36	1252810-16-16	18,75
280	25	1"	1 5/16"-12	1 1/4"-11,5	58,0	23,0	25,5	21,0	31,7	46	1252810-16-20	36,50
210	25	1"	1 5/16"-12	1 1/2"-11,5	62,0	23,0	26,0	21,0	32,0	50	1252810-16-24	44,50
210	28, 30, 32	1 1/4"	1 5/8"-12	1"-11,5	62,0	24,3	25,0	26,5	21,0	46	1252810-20-16	30,00
210	28, 30, 32	1 1/4"	1 5/8"-12	1 1/4"-11,5	62,0	24,3	25,5	26,5	31,7	46	1252810-20-20	30,00
210	28, 30, 32	1 1/4"	1 5/8"-12	1 1/2"-11,5	64,8	24,3	26,0	26,5	38,0	50	1252810-20-24	44,50
210	35, 38	1 1/2"	1 7/8"-12	1 1/2"-11,5	68,0	27,5	26,0	32,0	32,0	50	1252810-24-24	35,00
210	35, 38	1 1/2"	1 7/8"-12	1 1/4"-11,5	66,0	27,5	25,5	31,7	31,7	50	1252810-24-20	35,00
150	50	2"	2 1/2"-12	2"-11,5	72,0	33,9	26,0	45,0	45,0	65	1252810-32-32	68,90

JIC-37° - ADAPTER

JIC-37° - ADAPTORS

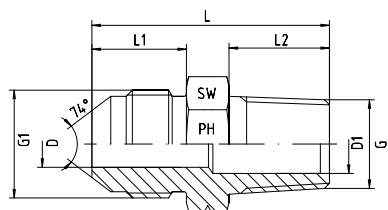

JIC - Männlich
Whithworth-Rohrgewinde - Kegelig - Männlich

JIC - Male
BSP - Taper - Male

Druck Pressure PN	Rohr A.D. Tube O.D.		Gewinde Thread		Ca. Maße Approx. Dimensions						Bestellzeichen Order-Code	Brutto-Preis Gross-Price Euro (€)
	mm	in.	G1 = UNF/UN	G = keg.	L	L1	L2	D	D1	SW		
315	6	1/4"	7/16"-20	1/8"-28	29,0	14,0	8	4,0	4,0	12	1252820-04-02	5,30
315	6	1/4"	7/16"-20	1/4"-19	33,0	14,0	12	4,0	4,0	14	1252820-04-04	5,30
315	6	1/4"	7/16"-20	3/8"-19	32,7	14,0	12	4,0	9,0	19	1252820-04-06	5,70
315	6	1/4"	7/16"-20	1/2"-14	42,0	14,0	20	4,0	13,0	22	1252820-04-08	8,65
315	8	5/16"	1/2"-20	1/8"-28	28,0	14,0	8	4,0	4,0	14	1252820-05-02	5,35
315	8	5/16"	1/2"-20	1/4"-19	33,0	14,0	12	5,0	5,0	14	1252820-05-04	5,35
315	8	5/16"	1/2"-20	3/8"-19	32,7	14,0	12	5,0	9,0	19	1252820-05-06	8,50
315	10	3/8"	9/16"-18	1/8"-28	28,0	14,0	8	6,0	4,0	17	1252820-06-02	5,78
315	10	3/8"	9/16"-18	1/4"-19	31,0	14,0	12	6,0	6,0	17	1252820-06-04	5,78
315	10	3/8"	9/16"-18	3/8"-19	30,7	14,0	12	6,0	6,0	19	1252820-06-06	5,78
315	10	3/8"	9/16"-18	1/2"-14	37,0	14,0	14	7,5	13,0	22	1252820-06-08	7,50
315	12	1/2"	3/4"-16	1/4"-19	36,0	17,0	12	9,0	5,0	19	1252820-08-04	7,20
315	12	1/2"	3/4"-16	3/8"-19	35,7	17,0	12	9,0	9,0	19	1252820-08-06	7,20
315	12	1/2"	3/4"-16	1/2"-14	39,7	17,0	14	9,5	9,5	22	1252820-08-08	7,85
315	12	1/2"	3/4"-16	3/4"-14	43,2	17,0	16	9,5	17,0	27	1252820-08-12	8,95
315	14, 15, 16	5/8"	7/8"-14	3/8"-19	38,7	19,5	12	12,0	9,0	24	1252820-10-06	8,65
315	14, 15, 16	5/8"	7/8"-14	1/2"-14	42,0	19,5	14	12,0	12,0	24	1252820-10-08	9,40
160	14, 15, 16	5/8"	7/8"-14	3/4"-14	44,2	19,5	16	12,0	18,0	27	1252820-10-12	9,90
315	18, 20	3/4"	1 1/16"-12	1/2"-14	46,2	22,0	14	15,0	13,5	27	1252820-12-08	12,25
160	18, 20	3/4"	1 1/16"-12	3/4"-14	48,3	22,0	16	15,0	15,0	27	1252820-12-12	12,25
160	18, 20	3/4"	1 1/16"-12	1"-11	50,5	22,0	18	15,0	21,0	36	1252820-12-16	25,10
160	25	1"	1 5/16"-12	1/2"-14	47,2	23,0	14	21,0	13,5	36	1252820-16-08	25,10
160	25	1"	1 5/16"-12	3/4"-14	49,0	23,0	16	21,0	18,0	36	1252820-16-12	18,75
160	25	1"	1 5/16"-12	1"-11	51,0	23,0	18	21,0	21,0	36	1252820-16-16	18,75
160	25	1"	1 5/16"-12	1 1/4"-11	53,0	23,0	20	21,0	32,0	46	1252820-16-20	36,50
160	25	1"	1 5/16"-12	1 1/2"-11	58,0	23,0	22	21,0	32,0	50	1252820-16-24	44,50
160	28, 30, 32	1 1/4"	1 5/8"-12	1"-11	55,0	24,3	18	26,5	21,0	46	1252820-20-16	30,00
160	28, 30, 32	1 1/4"	1 5/8"-12	1 1/4"-11	56,5	24,3	20	26,5	31,7	46	1252820-20-20	30,00
160	28, 30, 32	1 1/4"	1 5/8"-12	1 1/2"-11	60,8	24,3	22	26,5	38,0	50	1252820-20-24	44,50
140	35, 38	1 1/2"	1 7/8"-12	1 1/2"-11	64,0	27,5	22	32,0	32,0	50	1252820-24-24	35,00
140	35, 38	1 1/2"	1 7/8"-12	1 1/4"-11	60,0	27,5	20	31,7	31,7	50	1252820-24-20	35,00
140	50	2"	2 1/2"-12	2"-11	72,0	33,9	26	45,0	45,0	65	1252820-32-32	68,90

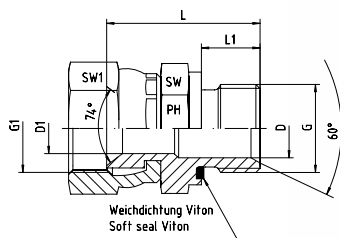

BSP - Männlich
Mit gekammter Weichdichtung
JIC - Weiblich

BSP - Male
With Captive Soft Seal
JIC - Female - Swivel

Druck Pressure PN	Rohr A.D. Tube O.D.		Gewinde Thread		Ca. Maße Approx. Dimensions						Bestellzeichen Order-Code G1 x G	Brutto-Preis Brutto-Price Euro (€)
	mm	in.	G1 = UNF/UN	G = BSP	L	L1	D	D1	SW1	SW		
350	6	1/4"	7/16"-20	1/8"-28	25,0	8	4,5	4,5	17	14	2052511-04-02	10,10
350	6	1/4"	7/16"-20	1/4"-18	29,0	12	4,5	4,5	17	19	2052511-04-04	10,10
350	6	1/4"	7/16"-20	3/8"-18	30,5	12	7,0	4,5	17	22	2052511-04-06	13,20
350	8	5/16"	1/2"-20	1/8"-28	25,0	8	4,5	4,5	17	14	2052511-05-02	10,10
350	8	5/16"	1/2"-20	1/4"-18	29,5	12	5,0	5,0	17	19	2052511-05-04	10,10
350	8	5/16"	1/2"-20	3/8"-18	30,5	12	7,0	5,0	17	22	2052511-05-06	13,20
350	10	3/8"	9/16"-18	1/8"-28	26,0	8	4,5	4,5	19	14	2052511-06-02	10,90
350	10	3/8"	9/16"-18	1/4"-18	30,0	12	6,0	6,0	19	19	2052511-06-04	10,10
350	10	3/8"	9/16"-18	3/8"-18	30,0	12	7,0	7,0	19	22	2052511-06-06	13,20
350	10	3/8"	9/16"-18	1/2"-14	34,0	14	12,5	7,0	19	27	2052511-06-08	14,35
350	12	1/2"	3/4"-16	1/4"-18	31,0	12	6,0	9,0	24	19	2052511-08-04	13,50
350	12	1/2"	3/4"-16	3/8"-18	33,5	12	9,0	9,0	24	22	2052511-08-06	13,95
350	12	1/2"	3/4"-16	1/2"-14	36,0	14	10,0	10,0	24	27	2052511-08-08	16,50
350	12	1/2"	3/4"-16	3/4"-14	39,0	16	15,0	10,0	24	32	2052511-08-12	23,95
350	14, 15, 16	5/8"	7/8"-14	3/8"-18	34,0	12	9,0	12,5	27	22	2052511-10-06	17,65
350	14, 15, 16	5/8"	7/8"-14	1/2"-14	34,0	14	12,5	12,5	27	27	2052511-10-08	17,80
350	14, 15, 16	5/8"	7/8"-14	5/8"-14	37,5	16	14,5	12,0	27	30	2052511-10-10	*
350	14, 15, 16	5/8"	7/8"-14	3/4"-14	41,0	16	15,0	12,5	27	32	2052511-10-12	23,95
350	18, 20	3/4"	1 1/16"-12	3/8"-18	34,0	12	9,0	9,0	32	27	2052511-12-06	26,90
350	18, 20	3/4"	1 1/16"-12	1/2"-14	38,0	14	12,5	12,5	32	27	2052511-12-08	23,10
350	18, 20	3/4"	1 1/16"-12	3/4"-14	40,0	16	15,0	15,0	32	32	2052511-12-12	23,25
350	18, 20	3/4"	1 1/16"-12	1"-11	42,5	18	21,0	15,0	32	41	2052511-12-16	42,95
280	25	1"	1 5/16"-12	1/2"-14	40,5	14	12,5	21,0	41	32	2052511-16-08	47,00
280	25	1"	1 5/16"-12	3/4"-14	46,5	16	15,0	20,0	41	32	2052511-16-12	42,95
280	25	1"	1 5/16"-12	1"-11	45,0	18	21,0	21,0	41	41	2052511-16-16	42,95
210	25	1"	1 5/16"-12	1 1/4"-11	48,0	20	29,0	21,0	41	50	2052511-16-20	78,80
210	28, 30, 32	1 1/4"	1 5/8"-12	1"-11	50,0	18	22,0	22,0	50	41	2052511-20-16	89,50
210	28, 30, 32	1 1/4"	1 5/8"-12	1 1/4"-11	53,0	20	27,5	27,5	50	50	2052511-20-20	78,80
210	35, 38	1 1/2"	1 7/8"-12	1 1/4"-11	55,0	20	29,0	29,0	55	50	2052511-24-20	115,00
210	35, 38	1 1/2"	1 7/8"-12	1 1/2"-11	59,0	22	33,0	33,0	55	55	2052511-24-24	99,90

JIC-37° - ADAPTER

JIC-37° - ADAPTORS

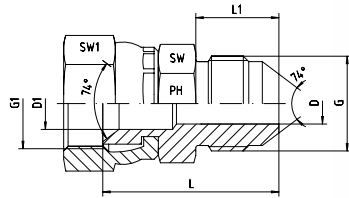

Form A

JIC - Männlich
JIC - Weiblich - Drehbar

JIC - Male
JIC - Female - Swivel

Druck Pressure PN	Rohr A.D. Tube O.D.		Gewinde Thread		Ca. Maße Approx. Dimensions						Form Form	Bestellzeichen Order-Code G1 x G	Brutto-Preis Gross-Price Euro (€)
	mm	in.	G1 = UNF/UN	G = UNF/UN	L	L1	D1	D	SW1	SW			
350	6	1/4"	7/16"-20	7/16"-20	29,0	14,0	4,0	4,0	17	12	A	2252511-04-04	11,30
350	6	1/4"	1/2"-20	7/16"-20	29,0	14,0	4,0	4,0	17	12	A	2252511-05-04	12,90
350	8	5/16"	1/2"-20	1/2"-20	30,0	14,0	5,0	5,0	17	14	A	2252511-05-05	11,50
350	10	3/8"	9/16"-18	9/16"-18	30,7	14,0	6,5	6,5	19	17	A	2252511-06-06	11,90
350	12	1/2"	9/16"-18	3/4"-16	34,5	17,0	7,0	9,5	19	22	A	2252511-06-08	21,50
350	12	1/2"	3/4"-16	3/4"-16	35,5	17,0	9,5	9,5	24	22	A	2252511-08-08	19,10
350	14, 15, 16	5/8"	3/4"-16	7/8"-14	39,4	19,5	10,0	12,0	24	24	A	2252511-08-10	24,90
350	12	1/2"	7/8"-14	3/4"-16	36,5	17,0	11,0	9,5	27	22	A	2252511-10-08	16,11
350	14, 15, 16	5/8"	7/8"-14	7/8"-14	40,5	19,5	12,0	12,0	27	24	A	2252511-10-10	21,50
350	18, 20	3/4"	7/8"-14	1 1/16"-12	45,5	22,0	12,0	15,0	27	27	A	2252511-10-12	22,50
350	14, 15, 16	5/8"	1 1/16"-12	7/8"-14	40,6	19,5	15,0	12,0	32	27	A	2252511-12-10	22,90
350	18, 20	3/4"	1 1/16"-12	1 1/16"-12	45,6	22,0	15,0	15,0	32	32	A	2252511-12-12	29,10
280	25	1"	1 5/16"-12	1 5/16"-12	48,7	23,0	21,0	21,0	41	36	A	2252511-16-16	41,50
210	28, 30, 32	1 1/2"	1 5/16"-12	1 5/8"-12	53,0	24,3	19,0	26,5	50	46	A	2252511-16-20	67,95
210	28, 30, 32	1 1/4"	1 5/8"-12	1 5/8"-12	56,0	24,3	27,5	27,5	50	46	A	2252511-20-20	67,50
210	35, 38	1 1/2"	1 7/8"-12	1 7/8"-12	60,0	27,5	33,0	33,0	55	50	A	2252511-24-24	75,00
	35, 38	1 1/2"	2 1/2"-12	1 7/8"-12	66,5	27,5	44,0	32,0	70	65	A	2252511-32-24	198,00

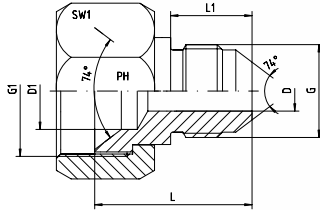

Form B

JIC - Männlich
JIC - Weiblich - Drehbar

JIC - Male
JIC - Female - Swivel

Druck Pressure PN	Rohr A.D. Tube O.D.		Gewinde Thread		Ca. Maße Approx. Dimensions						Form Form	Bestellzeichen Order-Code G1 x G	Brutto-Preis Gross-Price Euro (€)
	mm	in.	G1 = UNF/UN	G = UNF/UN	L	L1	D1	D	SW1	SW			
350	6	1/4"	9/16"-18	7/16"-20	26,0	14,0	7,0	4,0	19		B	2252511-06-04	9,39
350	6	1/4"	3/4"-16	7/16"-20	26,0	14,0	9,0	4,0	22		B	2252511-08-04	9,39
350	8	5/16"	3/4"-16	1/2"-20	26,0	14,0	9,0	6,0	22		B	2252511-08-05	12,90
350	10	3/8"	3/4"-16	9/16"-18	26,0	14,0	9,0	7,5	22		B	2252511-08-06	11,40
350	6	1/4"	7/8"-14	7/16"-20	28,0	14,0	11,0	4,5	27		B	2252511-10-04	14,70
350	10	3/8"	7/8"-14	9/16"-18	28,0	14,0	11,0	7,5	27		B	2252511-10-06	14,70
350	6	1/4"	1 1/16"-12	7/16"-20	28,5	14,0	15,0	4,0	32		B	2252511-12-04	18,50
350	10	3/8"	1 1/16"-12	9/16"-18	30,4	14,0	15,0	7,5	32		B	2252511-12-06	18,50
350	12	1/2"	1 1/16"-12	3/4"-16	33,0	17,0	15,0	9,5	32		B	2252511-12-08	18,50
280	6	1/4"	1 5/16"-12	7/16"-20	31,0	14,0	19,0	4,0	41		B	2252511-16-04	39,00
280	10	3/8"	1 5/16"-12	9/16"-18	32,0	14,0	19,0	7,5	41		B	2252511-16-06	39,00
280	12	1/2"	1 5/16"-12	3/4"-16	35,0	17,0	19,0	9,5	41		B	2252511-16-08	39,00
280	14, 15, 16	5/8"	1 5/16"-12	7/8"-14	37,0	19,5	19,0	12,0	41		B	2252511-16-10	39,00
280	18, 20	3/4"	1 5/16"-12	1 1/16"-12	40,0	22,0	19,0	15,5	41		B	2252511-16-12	39,00
210	12	1/2"	1 5/8"-12	3/4"-16	35,0	16,7	26,0	9,5	50		B	2252511-20-08	43,30
210	14, 15, 16	5/8"	1 5/8"-12	7/8"-14	37,3	19,5	26,0	12,0	50		B	2252511-20-10	43,30
210	18, 20	3/4"	1 5/8"-12	1 1/16"-12	40,0	22,0	26,0	15,0	50		B	2252511-20-12	43,30
210	25	1"	1 5/8"-12	1 5/16"-12	41,0	23,0	26,0	21,0	50		B	2252511-20-16	43,30
210	14, 15, 16	5/8"	1 7/8"-12	7/8"-14	41,0	19,3	30,0	12,0	60		B	2252511-24-10	84,30
210	25	1"	1 7/8"-12	1 5/16"-12	45,0	23,0	30,0	21,0	60		B	2252511-24-16	84,30
210	28, 30, 32	1 1/4"	1 7/8"-12	1 5/8"-12	62,0	24,3	32,0	26,5	60		B	2252511-24-20	84,30

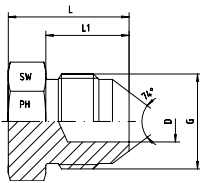

Verschlussstopfen
Männlich

Coned Plug
Male

Druck Pressure PN	Rohr A.D. Tube O.D.		Gewinde Thread G	Ca. Maße Approx. Dimensions				Bestellzeichen Order-Code	Brutto/Preis Gross-Price Euro (€)
	mm	in.		L	L1	D	SW		
350	6	1/4"	7/16"-20 UNF	20,5	14,0	4,0	12	5250010-04	4,50
350	8	5/16"	1/2"-20 UNF	20,5	14,0	5,0	14	5250010-05	4,50
350	10	3/8"	9/16"-18 UNF	22,0	14,0	7,0	17	5250010-06	5,50
350	12	1/2"	3/4"-16 UNF	24,0	17,0	9,5	22	5250010-08	6,25
350	14, 15, 16	5/8"	7/8"-14 UNF	28,0	19,5	12,0	24	5250010-10	8,50
350	18, 20	3/4"	1 1/16"-12 UN	33,0	22,0	15,0	27	5250010-12	12,00
280	25	1"	1 5/16"-12 UN	34,0	23,0	21,5	36	5250010-16	16,60
210	28, 30, 32	1 1/4"	1 5/8"-12 UN	37,7	24,3	27,5	46	5250010-20	27,50
210	35, 38	1 1/2"	1 7/8"-12 UN	42,5	27,5	33,0	50	5250010-24	38,75
150	50	2"	2 1/2"-12 UN	52,0	33,9	45,0	65	5250010-32	56,70

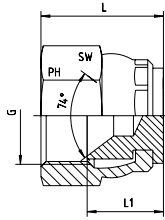

Verschlusskappe
JIC - Weiblich - Drehbare Mutter

Swivel Cap
JIC - Female - Swivel

Druck Pressure PN	Rohr A.D. Tube O.D.		Gewinde Thread G	Ca. Maße Approx. Dimensions			Bestellzeichen Order-Code	Brutto-Preis Gross-Price Euro (€)
	mm	in.		L	L1	SW		
350	6	1/4"	7/16"-20 UNF	20,0	12	17	5250011-04	7,87
350	8	5/16"	1/2"-20 UNF	22,0	12	17	5250011-05	7,87
350	10	3/8"	9/16"-18 UNF	23,0	13	19	5250011-06	9,00
350	12	1/2"	3/4"-16 UNF	25,5	14	24	5250011-08	9,20
350	14, 15, 16	5/8"	7/8"-14 UNF	30,0	18	27	5250011-10	11,10
350	18, 20	3/4"	1 1/16"-12 UN	33,0	18	32	5250011-12	18,10
280	25	1"	1 5/16"-12 UN	36,0	21	41	5250011-16	33,75
210	28, 30, 32	1 1/4"	1 5/8"-12 UN	39,5	22	50	5250011-20	43,75
210	35, 38	1 1/2"	1 7/8"-12 UN	44,0	24	55	5250011-24	54,80
	50	2"	2 1/2"-12 UN	56,0	32	70	5250011-32	117,00

JIC-37° - WINKEL-ADAPTER

JIC-37° - ELBOW ADAPTORS

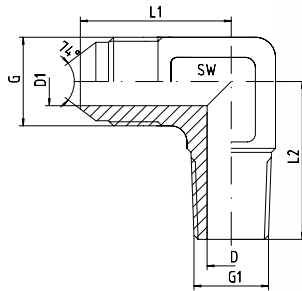

Außengewinde-Einschrauber - 90°
JIC - Männlich
NPT - Männlich

Male-90°-Elbow
JIC - Male
NPT - Male

Druck Pressure PN	Rohr A.D. Tube O.D.		Gewinde Thread		Ca. Maße Approx. Dimensions					Bestellzeichen Order-Code G x G1	Brutto-Preis Gross-Price Euro (€)
	mm	in.	G = UNF/UN	G1 = NPT	L1	L2	D	D1	SW		
350	6	1/4"	7/16"-20	1/8"-27	23,0	20,0	4,5	4,0	11	1252517-04-02	15,40
350	6	1/4"	7/16"-20	1/4"-18	28,5	26,5	4,5	4,5	14	1252517-04-04	15,40
350	6	1/4"	7/16"-20	3/8"-18	29,0	31,0	10,0	4,0	19	1252517-04-06	21,25
350	8	5/16"	1/2"-20	1/8"-27	24,0	20,0	4,5	6,0	13	1252517-05-02	15,40
350	8	5/16"	1/2"-20	1/4"-18	27,0	28,0	7,0	6,0	14	1252517-05-04	15,40
350	8	5/16"	1/2"-20	3/8"-18	29,0	31,0	10,0	6,0	19	1252517-05-06	20,95
350	10	3/8"	9/16"-18	1/8"-27	27,0	25,0	4,0	7,5	14	1252517-06-02	15,40
350	10	3/8"	9/16"-18	1/4"-18	27,0	25,0	7,5	7,5	14	1252517-06-04	14,75
350	10	3/8"	9/16"-18	3/8"-18	27,0	27,0	8,5	7,5	14	1252517-06-06	19,40
350	10	3/8"	9/16"-18	1/2"-14	31,0	36,0	13,0	7,5	19	1252517-06-08	26,90
350	12	1/2"	3/4"-16	1/4"-18	31,0	29,5	7,0	10,0	19	1252517-08-04	20,90
350	12	1/2"	3/4"-16	3/8"-18	31,0	29,5	10,0	10,0	19	1252517-08-06	19,40
350	12	1/2"	3/4"-16	1/2"-14	31,0	34,0	10,0	10,0	19	1252517-08-08	22,20
350	12	1/2"	3/4"-16	3/4"-14	37,0	41,5	15,5	10,0	24	1252517-08-12	35,00
350	14, 15, 16	5/8"	7/8"-14	3/8"-18	37,5	37,0	10,0	12,5	24	1252517-10-06	22,40
350	14, 15, 16	5/8"	7/8"-14	1/2"-14	37,5	38,0	14,0	12,5	24	1252517-10-08	22,40
280	14, 15, 16	5/8"	7/8"-14	3/4"-14	37,5	41,5	15,5	12,5	24	1252517-10-12	35,00
350	18, 20	3/4"	1 1/16"-12	1/2"-14	42,0	38,0	14,0	15,5	24	1252517-12-08	30,20
280	18, 20	3/4"	1 1/16"-12	3/4"-14	42,0	41,5	15,5	15,5	24	1252517-12-12	30,20
210	18, 20	3/4"	1 1/16"-12	1"-11,5	45,0	50,0	24,0	16,0	33	1252517-12-16	55,00
280	25	1"	1 5/16"-12	1/2"-14					33	1252517-16-08	55,00
280	25	1"	1 5/16"-12	3/4"-14	46,0	45,0	18,0	22,0	33	1252517-16-12	45,10
210	25	1"	1 5/16"-12	1"-11,5	49,0	50,0	21,0	22,0	33	1252517-16-16	42,10
210	28, 30, 32	1 1/4"	1 5/8"-12	1"-11,5	52,0	60,0	24,0	28,0	41	1252517-20-16	85,50
170	28, 30, 32	1 1/4"	1 5/8"-12	1 1/4"-11,5	52,0	61,0	32,0	28,0	45	1252517-20-20	74,90
140	35, 38	1 1/2"	1 7/8"-12	1 1/4"-11,5	59,0	57,0	32,0	33,0	48	1252517-24-20	139,80
140	35, 38	1 1/2"	1 7/8"-12	1 1/2"-11,5	64,0	59,0	33,0	33,0	50	1252517-24-24	122,50
140	50	2"	2 1/2"-12	2"-11,5	77,5	76,0	45,0	45,0	65	1252517-32-32	298,00

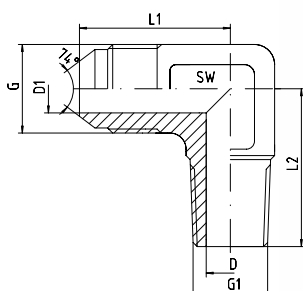

Außengewinde-Einschrauber - 90°
JIC - Männlich
Whitworth-Rohrgewinde - Kegelig - Männlich

Male-90°-Elbow
JIC - Male
BSP - Taper - Male

Druck Pressure PN	Rohr A.D. Tube O.D.		Gewinde Thread		Ca. Maße Approx. Dimensions					Bestellzeichen Order-Code G x G1	Brutto-Preis Gross-Price Euro (€)
	mm	in.	G = UNF/UN	G1 = keg.	L1	L2	D	D1	SW		
315	6	1/4"	7/16"-20	1/8"-28	23,0	20,0	5,0	4,0	12	1252520-04-02	15,40
315	6	1/4"	7/16"-20	1/4"-19	27,0	28,0	7,0	4,0	14	1252520-04-04	15,40
315	6	1/4"	7/16"-20	3/8"-19	27,0	30,0	10,0	4,0	19	1252520-04-06	21,25
315	8	5/16"	1/2"-20	1/8"-28	24,0	20,0	5,0	6,0	13	1252520-05-02	15,40
315	8	5/16"	1/2"-20	1/4"-19	27,0	28,0	7,0	6,0	14	1252520-05-04	15,40
315	8	5/16"	1/2"-20	3/8"-19	28,0	30,0	10,0	6,0	19	1252520-05-06	20,95
315	10	3/8"	9/16"-18	1/8"-28						1252520-06-02	15,40
315	10	3/8"	9/16"-18	1/4"-19	27,0	28,0	7,0	8,0	14	1252520-06-04	14,75
315	10	3/8"	9/16"-18	3/8"-19	29,0	31,0	10,0	8,0	19	1252520-06-06	19,40
315	10	3/8"	9/16"-18	1/2"-14	31,0	36,0	13,0	7,5	19	1252520-06-08	26,90
315	12	1/2"	3/4"-16	1/4"-19	32,0	31,0	7,0	10,0	19	1252520-08-04	20,90
315	12	1/2"	3/4"-16	3/8"-19	32,0	31,0	10,0	10,0	19	1252520-08-06	19,40
315	12	1/2"	3/4"-16	1/2"-14	34,0	37,0	14,0	10,0	22	1252520-08-08	22,20
315	14, 15, 16	5/8"	7/8"-14	3/8"-19	37,0	33,0	10,0	12,0	22	1252520-10-06	22,40
315	14, 15, 16	5/8"	7/8"-14	1/2"-14	37,0	37,0	14,0	12,0	22	1252520-10-08	22,40
160	14, 15, 16	5/8"	7/8"-14	3/4"-14	39,0	40,0	18,0	12,0	27	1252520-10-12	35,00
315	18, 20	3/4"	1 1/16"-12	1/2"-14	42,0	40,0	14,0	16,0	27	1252520-12-08	30,20
160	18, 20	3/4"	1 1/16"-12	3/4"-14	42,0	40,0	18,0	16,0	27	1252520-12-12	30,20
160	18, 20	3/4"	1 1/16"-12	1"-11	45,0	50,0	24,0	16,0	33	1252520-12-16	55,00
160	25	1"	1 5/16"-12	1/2"-14						1252520-16-08	55,00
160	25	1"	1 5/16"-12	3/4"-14	46,0	45,0	18,0	22,0	33	1252520-16-12	45,10
160	25	1"	1 5/16"-12	1"-11	46,0	50,0	24,0	22,0	33	1252520-16-16	42,10
160	28, 30, 32	1 1/4"	1 5/8"-12	1"-11	52,0	60,0	24,0	28,0	41	1252520-20-16	85,50
160	28, 30, 32	1 1/4"	1 5/8"-12	1 1/4"-11	52,0	61,0	32,0	28,0	41	1252520-20-20	74,90
140	35, 38	1 1/2"	1 7/8"-12	1 1/4"-11						1252520-24-20	139,80
140	35, 38	1 1/2"	1 7/8"-12	1 1/2"-11	64,0	59,0	33,0	33,0	50	1252520-24-24	122,50

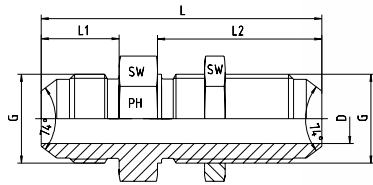

Gerade Schottverschraubungen

Straight Bulkhead Connections

Druck Pressure PN	Rohr A.D. Tube O.D.		Gewinde Thread G	Ca. Maße Approx. Dimensions					Bestellzeichen Order-Code	Brutto-Preis Gross-Price Euro (€)
	mm	in.		L	L1	L2	D	SW		
350	6	1/4"	7/16"-20 UNF	52,5	14,0	31,5	4,0	17	1252513-04-04	9,98
350	8	5/16"	1/2"-20 UNF	52,5	14,0	31,5	6,0	19	1252513-05-05	10,30
350	10	3/8"	9/16"-18 UNF	55,5	14,0	33,0	7,5	22	1252513-06-06	11,73
350	12	1/2"	3/4"-16 UNF	62,0	16,5	37,0	10,0	24	1252513-08-08	13,85
350	14, 15, 16	5/8"	7/8"-14 UNF	69,5	19,0	40,5	12,0	30	1252513-10-10	18,95
350	18, 20	3/4"	1 1/16"-12 UN	78,5	21,5	45,0	15,5	36	1252513-12-12	25,80
280	25	1"	1 5/16"-12 UN	80,0	23,1	44,4	21,5	41	1252513-16-16	39,95
210	28, 30, 32	1 1/4"	1 5/8"-12 UN	84,0	24,3	45,7	27,5	50	1252513-20-20	52,50
210	35, 38	1 1/2"	1 7/8"-12 UN	89,5	27,5	46,0	33,0	55	1252513-24-24	77,25
150	50	2"	2 1/2"-12 UN	106,5	33,9	53,0	45,0	70	1252513-32-32	249,00



Winkel-Schottverschraubungen - 90°

90°-Elbow Bulkhead Connections

Druck Pressure PN	Rohr A.D. Tube O.D.		Gewinde Thread G	Ca. Maße Approx. Dimensions						Bestellzeichen Order-Code	Brutto-Preis Gross-Price Euro (€)
	mm	in.		L	L1	L2	D	SW	SW1		
350	6	1/4"	7/16"-20 UNF	40	25	26	4,0	11	17	1252521-04-04	58,80
350	8	5/16"	1/2"-20 UNF	44	27	26	6,0	13	19	1252521-05-05	69,30
350	10	3/8"	9/16"-18 UNF	46	28	28	8,0	14	22	1252521-06-06	69,30
350	12	1/2"	3/4"-16 UNF	54	36	32	10,0	19	24	1252521-08-08	86,10
350	14, 15, 16	5/8"	7/8"-14 UNF	61	40	35	12,0	22	30	1252521-10-10	100,80
350	18, 20	3/4"	1 1/16"-12 UN	68	45	40	16,0	27	36	1252521-12-12	132,35
280	25	1"	1 5/16"-12 UN	71	49	40	22,0	41	41	1252521-16-16	163,80
210	28, 30, 32	1 1/4"	1 5/8"-12 UN	80	55	41	28,0	41	50	1252521-20-20	249,00
210	35, 38	1 1/2"	1 7/8"-12 UN							1252521-24-24	520,00

Für Schottverschraubungen

For Bulkhead Couplings

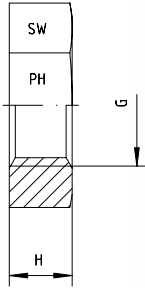

Gewinde Thread G = UNF/UN	H	SW	Bestellzeichen Order-Code	Brutto-Preis Gross-Price Euro (€)
7/16"-20 UNF	6,4	17	1252523-04	2,90
1/2"-20 UNF	6,4	19	1252523-05	3,50
9/16"-18 UNF	6,9	22	1252523-06	3,80
3/4"-16 UNF	7,9	24	1252523-08	4,30
7/8"-14 UNF	9,1	30	1252523-10	6,30
1 1/16"-12 UN	10,4	36	1252523-12	6,90
1 5/16"-12 UN	10,4	41	1252523-16	8,50
1 5/8"-12 UN	10,4	50	1252523-20	13,00
1 7/8"-12 UN	10,4	55	1252523-24	17,00
2 1/2"-12 UN	10,4	70	1252523-32	37,50

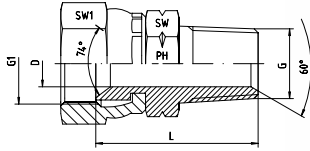

JIC - Weiblich - Drehbar
NPT - Männlich

JIC - Female - Swivel
NPT - Male

Druck Pressure PN	Rohr A.D. Tube O.D.		Gewinde Thread		Ca. Maße Approx. Dimensions				Bestellzeichen Order-Code G1 x G	Brutto-Preis Gross-Price Euro (€)
	mm	in.	G1 = UNF/UN	G = NPT	L	D	SW1	SW		
350	6	1/4"	7/16"-20	1/8"-27	24,0	4,0	17	12	1252518-04-02	15,10
350	6	1/4"	7/16"-20	1/4"-18	30,0	4,0	17	17	1252518-04-04	15,10
350	6	1/4"	7/16"-20	3/8"-18	30,0	4,0	17	19	1252518-04-06	20,50
350	8	5/16"	1/2"-20	1/8"-27	24,0	4,0	17	12	1252518-05-02	15,90
350	8	5/16"	1/2"-20	1/4"-18	30,0	4,0	17	14	1252518-05-04	15,90
350	8	5/16"	1/2"-20	3/8"-18	31,0	4,0	17	19	1252518-05-06	20,50
350	10	3/8"	9/16"-18	1/8"-27	24,5	4,0	19	14	1252518-06-02	15,20
350	10	3/8"	9/16"-18	1/4"-18	30,0	6,0	19	17	1252518-06-04	15,20
350	10	3/8"	9/16"-18	3/8"-18	31,5	7,0	19	19	1252518-06-06	15,20
350	10	3/8"	9/16"-18	1/2"-14	36,0	7,0	19	22	1252518-06-08	22,90
350	12	1/2"	3/4"-16	1/4"-18	32,0	6,0	24	17	1252518-08-04	20,95
350	12	1/2"	3/4"-16	3/8"-18	32,5	9,0	24	19	1252518-08-06	20,30
350	12	1/2"	3/4"-16	1/2"-14	39,0	9,0	24	22	1252518-08-08	20,20
280	12	1/2"	3/4"-16	3/4"-14	40,0	10,0	24	27	1252518-08-12	30,40
350	14, 15, 16	5/8"	7/8"-14	3/8"-18	35,0	9,0	27	22	1252518-10-06	25,90
350	14, 15, 16	5/8"	7/8"-14	1/2"-14	40,0	12,0	27	22	1252518-10-08	25,00
280	14, 15, 16	5/8"	7/8"-14	3/4"-14	41,0	12,5	27	27	1252518-10-12	27,90
280	18, 20	3/4"	1 1/16"-12	1/2"-14	41,0	13,5	32	27	1252518-12-08	28,50
280	18, 20	3/4"	1 1/16"-12	3/4"-14	41,0	15,0	32	27	1252518-12-12	28,50
280	18, 20	3/4"	1 1/16"-12	1"-11,5	46,0	15,0	32	36	1252518-12-16	44,50
280	25	1"	1 5/16"-12	1/2"-14					1252518-16-08	*
280	25	1"	1 5/16"-12	3/4"-14	45,0	18,0	41	32	1252518-16-12	44,90
280	25	1"	1 5/16"-12	1"-11,5	48,0	21,0	41	36	1252518-16-16	41,90
210	25	1"	1 5/16"-12	1 1/4"-11,5	52,0	21,0	41	46	1252518-16-20	69,00
210	28, 30, 32	1 1/4"	1 5/8"-12	1"-11,5	48,5	21,0	50	41	1252518-20-16	60,20
210	28, 30, 32	1 1/4"	1 5/8"-12	1 1/4"-11,5	52,0	27,5	50	46	1252518-20-20	60,20
210	28, 30, 32	1 1/4"	1 5/8"-12	1 1/2"-11,5			50		1252518-20-24	*
210	35, 38	1 1/2"	1 7/8"-12	1 1/4"-11,5	54,0	32,0	55	46	1252518-24-20	85,85
210	35, 38	1 1/2"	1 7/8"-12	1 1/2"-11,5	54,5	33,0	55	50	1252518-24-24	85,85

JIC-37° - WINKEL-ADAPTER

JIC-37° - ELBOW ADAPTORS

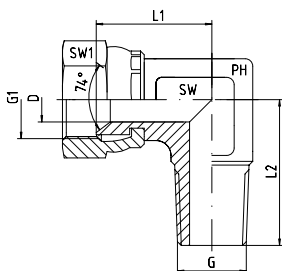

Winkel-Adapter
JIC - Weiblich - Drehbar
NPT - Männlich

90°-Swivel-Male-Elbow
JIC - Female - Swivel
NPT - Male

Druck Pressure PN	Rohr A.D. Tube O.D.		Gewinde Thread		Ca. Maße Approx. Dimensions					Bestellzeichen Order-Code G1 x G	Brutto-Preis Gross-Price Euro (€)
	mm	in.	G1 = UNF/UN	G = NPT	L1	L2	D	SW	SW1		
350	6	1/4"	7/16"-20	1/8"-27	18,5	20,0	4,5	12	17	1252519-04-02	16,25
350	6	1/4"	7/16"-20	1/4"-18	18,5	25,0	4,5	14	17	1252519-04-04	16,25
350	6	1/4"	7/16"-20	3/8"-18					17	1252519-04-06	*
350	8	5/16"	1/2"-20	1/8"-27					17	1252519-05-02	17,90
350	8	5/16"	1/2"-20	1/4"-18	18,5	25,0	6,0	14	17	1252519-05-04	17,90
350	8	5/16"	1/2"-20	3/8"-18					17	1252519-05-06	*
350	10	3/8"	9/16"-18	1/4"-18	22,3	25,0	7,5	14	19	1252519-06-04	17,90
350	10	3/8"	9/16"-18	3/8"-18	22,3	27,0	7,5	14	19	1252519-06-06	17,90
350	10	3/8"	9/16"-18	1/2"-14					19	1252519-06-08	*
350	12	1/2"	3/4"-16	1/4"-18	24,5	29,5	10,0	19	24	1252519-08-04	24,50
350	12	1/2"	3/4"-16	3/8"-18	24,5	29,5	10,0	19	24	1252519-08-06	23,95
350	12	1/2"	3/4"-16	1/2"-14	24,5	34,0	10,0		24	1252519-08-08	23,25
280	12	1/2"	3/4"-16	3/4"-14					24	1252519-08-12	*
350	14, 15, 16	5/8"	7/8"-14	3/8"-18	29,5	37,0	12,0	24	27	1252519-10-06	26,95
350	14, 15, 16	5/8"	7/8"-14	1/2"-14	29,5	38,0	12,0	24	27	1252519-10-08	26,75
280	14, 15, 16	5/8"	7/8"-14	3/4"-14	29,5	41,5	12,0	24	27	1252519-10-12	28,90
280	18, 20	3/4"	1 1/16"-12	1/2"-14	31,0	38,0	15,5	24	32	1252519-12-08	33,75
280	18, 20	3/4"	1 1/16"-12	3/4"-14	31,0	41,5	15,5	24	32	1252519-12-12	33,75
280	18, 20	3/4"	1 1/16"-12	1"-11,5					32	1252519-12-16	*
280	25	1"	1 5/16"-12	3/4"-14	37,0	46,0	21,0	33	41	1252519-16-12	52,90
280	25	1"	1 5/16"-12	1"-11,5					33	1252519-16-16	47,50
210	25	1"	1 5/16"-12	1 1/4"-11,5					41	1252519-16-20	*
210	28, 30, 32	1 1/4"	1 5/8"-12	1"-11,5					50	1252519-20-16	*
210	28, 30, 32	1 1/4"	1 5/8"-12	1 1/4"-11,5					50	1252519-20-20	63,25
210	28, 30, 32	1 1/4"	1 5/8"-12	1 1/2"-11,5					50	1252519-20-24	*
210	35, 38	1 1/2"	1 7/8"-12	1 1/4"-11,5					55	1252519-24-20	*
210	35, 38	1 1/2"	1 7/8"-12	1 1/2"-11,5	47,2	63,0	33,0	50	55	1252519-24-24	117,85

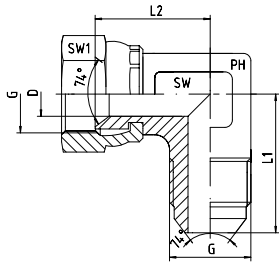

Winkel-Adapter - 90°
DKJ - AGJ

Swivel-Elbow-Adaptors - 90°
DKJ - AGJ

Druck Pressure PN	Rohr A.D. Tube O.D.		Gewinde Thread G = UNF/UN	Ca. Maße Approx. Dimensions					Bestellzeichen Order-Code	Brutto-Preis Gross-Price Euro (€)
	mm	in.		L1	L2	D	SW	SW1		
350	6	1/4"	7/16"-20	22,5	16,7	4,0	12	16	1252514-04-04	23,50
350	8	5/16"	1/2"-20	24,0	17,5	5,5	13	17	1252514-05-05	21,40
350	10	3/8"	9/16"-18	27,0	22,5	7,5	14	19	1252514-06-06	26,80
350	12	1/2"	3/4"-16	32,0	24,5	10,0	19	24	1252514-08-08	32,70
350	14, 15, 16	5/8"	7/8"-14	37,5	29,5	12,0	24	27	1252514-10-10	35,35
350	18, 20	3/4"	1 1/16"-12	42,0	31,0	15,5	24	32	1252514-12-12	41,75
250	25	1"	1 5/16"-12	46,0	35,7	21,5	33	41	1252514-16-16	63,55
210	28, 30, 32	1 1/4"	1 5/8"-12	52,5	42,8	27,5	41	50	1252514-20-20	90,75
140	35, 38	1 1/2"	1 7/8"-12	59,0	47,2	33,0	50	55	1252514-24-24	125,00
150	50	2"	2 1/2"-12	77,5	62,1	45,0	65	70	1252514-32-32	537,00

JIC-37° - WINKEL-ADAPTER

JIC-37° - ELBOW ADAPOTRS

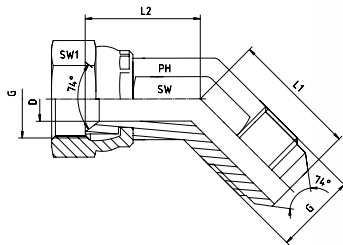

Winkel-Adapter - 45°
DKJ - AGJ

Swivel-Elbow-Adaptors - 45°
DKJ - AGJ

Druck Pressure PN	Rohr A.D. Tube O.D.		Gewinde Thread G = UNF/UN	Ca. Maße Approx. Dimensions					Bestellzeichen Order-Code	Brutto-Preis Gross-Price Euro (€)
	mm	in.		L1	L2	D	SW	SW1		
350	6	1/4"	7/16"-20	18,0	15,0	4,0	12	14	1252522-04-04	35,25
350	8	5/16"	1/2"-20	20,0	16,0	5,5	14	17	1252522-05-05	32,10
350	10	3/8"	9/16"-18	21,0	19,0	7,5	14	19	1252522-06-06	40,20
350	12	1/2"	3/4"-16	25,0	22,0	10,0	19	24	1252522-08-08	49,05
350	14, 15, 16	5/8"	7/8"-14	28,0	24,0	12,0	24	27	1252522-10-10	53,00
350	18, 20	3/4"	1 1/16"-12	33,0	24,0	15,5	24	32	1252522-12-12	62,60
250	25	1"	1 5/16"-12	37,0	29,0	21,5	33	41	1252522-16-16	95,30
210	28, 30, 32	1 1/4"	1 5/8"-12	40,0	36,0	27,5	41	50	1252522-20-20	144,00
140	35, 38	1 1/2"	1 7/8"-12	45,0	39,0	33,0	48	60	1252522-24-24	188,00
150	50	2"	2 1/2"-12	56,5	50,1	45,0	65	70	1252522-32-32	749,00

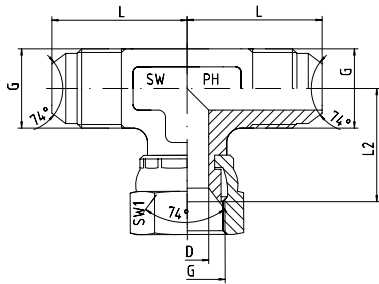

TE-Adapter
AGJ - DKJ - AGJ

Swivel-Branch-Tee
AGJ - DKJ - AGJ

Druck Pressure PN	Rohr A.D. Tube O.D.		Gewinde Thread G	Ca. Maße Approx. Dimensions					Bestellzeichen Order-Code	Brutto-Preis Gross-Price Euro (€)
	mm	in.		L	L2	D	SW	SW1		
350	6	1/4"	7/16"-20 UNF	22,5	16,7	4,0	12	14	1252515-04-04-04	28,90
350	8	5/16"	1/2"-20 UNF	24,0	17,5	5,5	13	17	1252515-05-05-05	28,90
350	10	3/8"	9/16"-18 UNF	27,0	22,3	7,5	14	19	1252515-06-06-06	30,40
350	12	1/2"	3/4"-16 UNF	31,0	24,5	10,0	19	24	1252515-08-08-08	41,75
350	14, 15, 16	5/8"	7/8"-14 UNF	37,5	29,5	12,0	24	27	1252515-10-10-10	46,25
350	18, 20	3/4"	1 1/16"-12 UN	42,0	31,0	15,5	24	32	1252515-12-12-12	55,25
250	25	1"	1 5/16"-12 UN	46,0	35,7	21,5	33	41	1252515-16-16-16	70,75
210	28, 30, 32	1 1/4"	1 5/8"-12 UN	52,5	42,8	27,5	41	50	1252515-20-20-20	121,00
170	35, 38	1 1/2"	1 7/8"-12 UN	59,0	47,2	33,0	50	60	1252515-24-24-24	148,50
150	50	2"	2 1/2"-12 UN	77,5	62,1	45,0	65	70	1252515-32-32-32	498,00

JIC-37° - LE-ADAPTER

JIC-37° - TEE-ADAPTORS

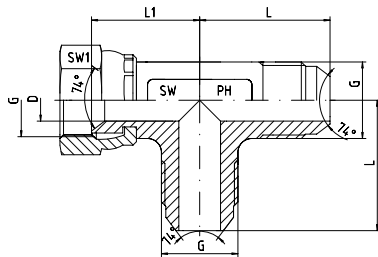

LE-Adapter
DKJ - AGJ - AGJ

Swivel-Run-Tee
DKJ - AGJ - AGJ

Druck Pressure PN	Rohr A.D. Tube O.D.		Gewinde Thread G	Ca. Maße Approx. Dimensions					Bestellzeichen Order-Code	Brutto-Preis Gross-Price Euro (€)
	mm	in.		L	L1	D	SW	SW1		
350	6	1/4"	7/16"-20 UNF	22,5	16,7	4,0	12	14	1252516-04-04-04	28,90
350	8	5/16"	1/2"-20 UNF	24,0	17,5	5,5	13	17	1252516-05-05-05	28,90
350	10	3/8"	9/16"-18 UNF	27,0	22,3	7,5	14	19	1252516-06-06-06	30,40
350	12	1/2"	3/4"-16 UNF	31,0	24,5	10,0	19	24	1252516-08-08-08	41,75
350	14, 15, 16	5/8"	7/8"-14 UNF	37,5	29,5	12,0	24	27	1252516-10-10-10	46,25
350	18, 20	3/4"	1 1/16"-12 UN	42,0	31,0	15,5	24	32	1252516-12-12-12	55,25
250	25	1"	1 5/16"-12 UN	46,0	35,7	21,5	33	41	1252516-16-16-16	70,75
210	28, 30, 32	1 1/4"	1 5/8"-12 UN	52,5	42,8	27,5	41	50	1252516-20-20-20	121,00
170	35, 38	1 1/2"	1 7/8"-12 UN	59,9	47,2	33,0	50	60	1252516-24-24-24	148,50
150	50	2"	2 1/2"-12 UN	77,5	62,1	45,0	65	70	1252516-32-32-32	498,00

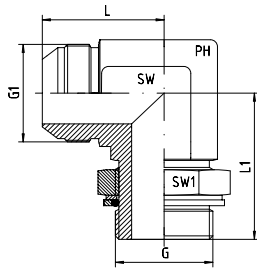

Einstellbare Winkel-Verschraubungen - 90°
Einschraubgewinde G: Whitworth-Rohrgewinde - Zylindrisch
Abdichtung durch gekammerten O-Ring

*Adjustable Stud Elbows - 90°
Thread: BSP - Parallel
Sealing by Captive O-ring and Washer*

Druck Pressure PN	Rohr A.D. Tube O.D.		Gewinde Thread		Ca. Maße Approx. Dimensions				Bestellzeichen Order-Code G1 x G	Brutto-Preis Gross-Price Euro (€)
	mm	in.	G1 = UNF/UN	G = BSP	L	L1	SW	SW1		
250	6	1/4"	7/16"-20	1/8"	22,6	26,5	11	14	1252530-04-02	18,80
200	6	1/4"	7/16"-20	1/4"	22,6	32,0	14	19	1252530-04-04	18,80
200	8	5/16"	1/2"-20	1/4"	26,6	32,0	14	19	1252530-05-04	18,80
200	10	3/8"	9/16"-18	1/4"	26,9	32,0	14	19	1252530-06-04	19,00
200	10	3/8"	9/16"-18	3/8"	29,0	37,0	19	22	1252530-06-06	25,00
200	10	3/8"	9/16"-18	1/2"	31,0	43,0	22	27	1252530-06-08	29,70
200	12	1/2"	3/4"-16	3/8"	31,8	37,0	19	22	1252530-08-06	27,00
200	12	1/2"	3/4"-16	1/2"	33,8	43,0	22	27	1252530-08-08	29,70
200	14, 15, 16	5/8"	7/8"-14	1/2"	36,8	43,0	22	27	1252530-10-08	29,70
200	18, 20	3/4"	1 1/16"-12	1/2"	42,2	49,5	27	27	1252530-12-08	40,00
200	18, 20	3/4"	1 1/16"-12	3/4"	42,2	49,5	27	36	1252530-12-12	40,90
200	25	1"	1 5/16"-12	1"	46,0	52,0	33	41	1252530-16-16	55,90
160	28, 30, 32	1 1/4"	1 5/8"-12	1 1/4"	52,3	57,0	41	50	1252530-20-20	105,00
140	35, 38	1 1/2"	1 7/8"-12	1 1/2"	59,2	61,0	50	55	1252530-24-24	229,00

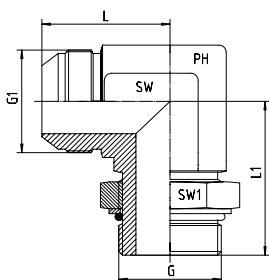

Einstellbare Winkel-Verschraubungen - 90°
Einschraubgewinde G: UN/UNF
Abdichtung durch O-Ring

*Adjustable Stud Elbows - 90°
Thread: UN/UNF
Sealing by O-ring*

Druck Pressure PN	Rohr A.D. Tube O.D.		Gewinde Thread		Ca. Maße Approx. Dimensions				Bestellzeichen Order-Code G1 x G	Brutto-Preis Gross-Price Euro (€)
	mm	in.	G1 = UNF/UN	G = UN/UNF	L	L1	SW	SW1		
350	6	1/4"	7/16"-20	7/16"-20	23	26	11	14	1252533-04-04	24,40
350	8	5/16"	1/2"-20	1/2"-20	24	29	13	16	1252533-05-05	24,90
350	10	3/8"	9/16"-18	9/16"-18	27	32	14	17	1252533-06-06	32,00
350	12	1/2"	3/4"-16	3/4"-16	32	37	19	22	1252533-08-08	37,50
350	14, 15, 16	5/8"	7/8"-14	7/8"-14	37	43	22	27	1252533-10-10	45,00
350	18, 20	3/4"	1 1/16"-12	1 1/16"-12	42	49	27	32	1252533-12-12	51,90
280	25	1"	1 5/16"-12	1 5/16"-12	46	52	33	38	1252533-16-16	73,00
210	28, 30, 32	1 1/4"	1 5/8"-12	1 5/8"-12	52	57	41	50	1252533-20-20	149,00
140	35, 38	1 1/2"	1 7/8"-12	1 7/8"-12	59	61	50	55	1252533-24-24	244,00

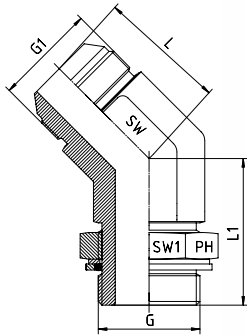

Einstellbare Winkel-Verschraubungen - 45°
Einschraubgewinde G: Whitworth-Rohrgewinde - Zylindrisch
Abdichtung durch gekammerten O-Ring

Adjustable Stud Elbows - 45°
Thread: BSP - Parallel
Sealing by Captive O-ring and Washer

Druck Pressure PN	Rohr A.D. Tube O.D.		Gewinde Thread		Ca. Maße Approx. Dimensions				Bestellzeichen Order-Code G1 x G	Brutto-Preis Gross-Price Euro (€)
	mm	in.	G1 = UNF/UN	G = BSP	L	L1	SW	SW1		
250	6	1/4"	7/16"-20	1/8"	18	27	11	14	1252534-04-02	20,70
200	6	1/4"	7/16"-20	1/4"	21	29	14	19	1252534-04-04	20,70
200	8	5/16"	1/2"-20	1/8"	20	27	14	14	1252534-05-02	20,70
200	8	5/16"	1/2"-20	1/4"	21	27	14	19	1252534-05-04	20,70
200	10	3/8"	9/16"-18	1/4"	21	29	14	19	1252534-06-04	20,70
200	10	3/8"	9/16"-18	3/8"	22	33	19	22	1252534-06-06	27,50
200	10	3/8"	9/16"-18	1/2"	22	39	22	27	1252534-06-08	32,70
200	12	1/2"	3/4"-16	3/8"	25	33	19	22	1252534-08-06	29,70
200	12	1/2"	3/4"-16	1/2"	25	39	22	27	1252534-08-08	32,70
200	14, 15, 16	5/8"	7/8"-14	1/2"	28	39	22	27	1252534-10-08	32,70
200	18, 20	3/4"	1 1/16"-12	3/4"	33	44	27	36	1252534-12-12	45,50

37° - BÖRDEL- MANOMETERVERSCHRAUBUNGEN

37° - FLARE-GAUGE COUPLINGS



EDELSTAHL / STAINLESS STEEL
VERBINDUNGSTECHNIK
FLUID CONNECTORS

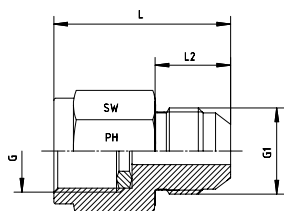

Mit JIC-Gewinde und Dichtkantenring - DKRi
Innengewinde: Whitworth-Rohrgewinde - Zylindrisch

With JIC - Male and Metal Sealing Ring - DKRi
Internal Thread: BSP - Female - Parallel

Druck Pressure PN	Rohr A.D. Tube O.D.		Gewinde Thread		Ca. Maße Approx. Dimensions			Bestellzeichen Order-Code G1 x G	Brutto-Preis Gross-Price Euro (€)
	mm	in.	G1 = UNF	G = BSP	L	L2	SW		
350	6	1/4"	7/16"-20	1/4"-19	33	14	17	1252531-04-04	19,00
350	6	1/4"	7/16"-20	1/2"-14	40	14	27	1252531-04-08	29,90
350	8	5/16"	1/2"-20	1/4"-19	33	14	17	1252531-05-04	19,00
350	8	5/16"	1/2"-20	1/2"-14	40	14	27	1252531-05-08	29,90
350	10	3/8"	9/16"-18	1/4"-19	30	14	17	1252531-06-04	19,00
350	10	3/8"	9/16"-18	1/2"-14	40	14	27	1252531-06-08	27,50
350	12	1/2"	3/4"-16	1/4"-19	31	17	22	1252531-08-04	24,40
350	12	1/2"	3/4"-16	1/2"-14	44	17	27	1252531-08-08	25,50



37° - BÖRDEL- AUFSCHRAUBVERSCHRAUBUNGEN

37° - FLARE-FEMALE-STUD-ADAPTORS

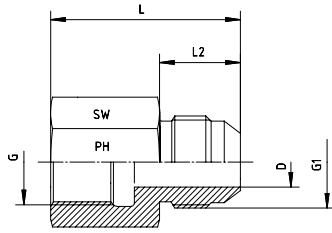

Mit JIC-Gewinde
Innengewinde: Whitworth-Rohrgewinde - Zylindrisch

JIC - Male
Internal Thread: BSP - Female - Fixed

Druck Pressure PN	Rohr A.D. Tube O.D.		Gewinde Thread		Ca. Maße Approx. Dimensions				Bestellzeichen Order-Code G1 x G	Brutto-Preis Gross-Price Euro (€)
	mm	in.	G1 = UNF/UN	G = BSP	L	L2	D	SW		
350	6	1/4"	7/16"-20	1/8"-28	30,0	14,0	4,5	14	1252532-04-02	10,30
350	6	1/4"	7/16"-20	1/4"-19	35,0	14,0	4,5	19	1252532-04-04	10,30
350	8	5/16"	1/2"-20	1/8"-28	30,0	14,0	5,0	14	1252532-05-02	13,50
350	8	5/16"	1/2"-20	1/4"-19	35,0	14,0	6,0	19	1252532-05-04	13,50
350	10	3/8"	9/16"-18	1/4"-19	35,5	14,0	7,5	19	1252532-06-04	13,50
350	10	3/8"	9/16"-18	3/8"-19	37,0	14,0	7,5	22	1252532-06-06	11,30
350	12	1/2"	3/4"-16	3/8"-19	39,5	17,0	10,0	22	1252532-08-06	14,90
350	12	1/2"	3/4"-16	1/2"-14	45,5	17,0	10,0	27	1252532-08-08	14,90
350	14, 15, 16	5/8"	7/8"-14	1/2"-14	48,0	19,5	12,5	27	1252532-10-08	17,00
315	18, 20	3/4"	1 1/16"-12	3/4"-14	52,0	22,0	15,5	36	1252532-12-12	23,50
280	25	1"	1 5/16"-12	1"-11	59,5	23,0	21,5	41	1252532-16-16	37,00
210	28, 30, 32	1 1/4"	1 5/8"-12	1 1/4"-11	63,0	24,3	27,5	50	1252532-20-20	53,00
140	35, 38	1 1/2"	1 7/8"-12	1 1/2"-11	66,5	27,5	33,0	55	1252532-24-24	72,50



EDELSTAHL / STAINLESS STEEL
VERBINDUNGSTECHNIK
FLUID CONNECTORS

Bördelanschlussteile für Verschraubungs- stutzen mit 24°-Innenkonus

Flare Coupling Parts for Coupling Bodies with 24°-Cone





BÖRDELANSCHLUSSTEILE FÜR VERSCHRAUBUNGEN MIT 24° - INNENKONUS - W DIN 3861

FLARE COUPLING PARTS FOR COUPLING BODIES WITH 24°-CONE - W DIN 3861

Produktgruppen	Product Groups	Seite Page
Montageanleitung	<i>Assembly Instruction</i>	7.2
 Rohranschlussteile	<i>Tube Connecting Parts</i>	
- Überwurfmuttern	- <i>Nuts</i>	7.3
- Druckringe	- <i>Flare Sleeves</i>	7.4
- Zwischenringe mit O-Ring	- <i>O-ring Adaptors</i>	7.5
- Anschlussteile komplett	- <i>Complete Parts</i>	7.6

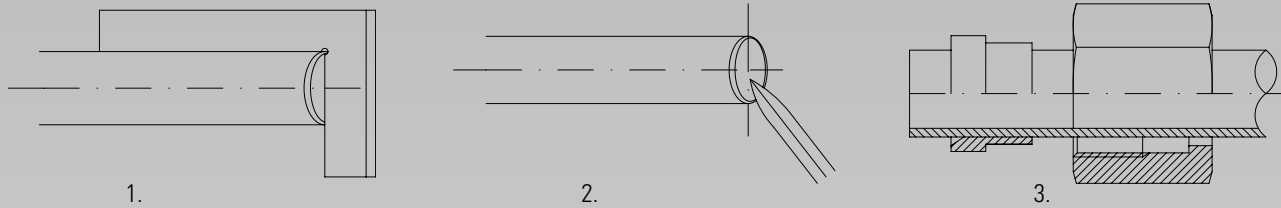

1. Rohr rechtwinklig absägen (keinen Rohrabschneider verwenden).
2. Innen und außen leicht entgraten, nicht anfasen. Rohrende reinigen, da sonst die Dichtfläche des Rohres beim Bördeln beschädigt wird.
3. Überwurfmutter und Druckring nach Abbildung auf das Rohr schieben.
4. Rohr mit Bördelwerkzeug oder Maschine bördeln. Der Bördeldurchmesser DB darf nicht außerhalb der in der Tabelle angegebenen Grenzen liegen.

1. Cut the tube square (do not use a pipe cutter).
2. Deburr the pipe inside and outside, do not chamfer. Clean the tube end, otherwise the sealing surface of the tube will be damaged when it is flared.
3. Slide the nut and the collar over the tube as shown in the illustration.
4. Flare the tube by means of flaring tools or a flaring machine. The flare diameter DB must not be out of the limits given in the table. The flare cone must be square to the tubular axle and concentric to the collar. The inner cone must be clean and free of flutes.

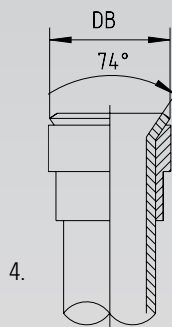

Rohr A.D. / Tube O.D.	6	8	10	12	14	15	16	18
DB min.	9,1	11,3	13,1	15,3	18,6	19,1	20,6	23,2
DB max.	10,0	12,0	14,0	16,0	19,6	20,0	22,0	24,0
Rohr A.D. / Tube O.D.	20	22	25	28	30	35	38	42
DB min.	25,6	26,5	31,1	32,7	37,0	41,8	46,0	48,8
DB max.	26,8	27,5	33,0	33,3	38,7	42,7	47,2	49,8

Der Bördelkegel muss rechtwinklig zur Rohrachse und zentrisch zum Druckring sein, der Innenkegel riefenfrei und sauber.

5. Bei Edelstahl-Verschraubungen müssen die Gewinde geschmiert werden (wie z.B. Gleitmo 810 oder High Tech Paste ASW 040 P; siehe Kapitel 12).

Es handelt sich hierbei um spezielle Schmierstoffe für Edelstahl-Verschraubungen.

6. / 7. Zwischenring in Verschraubungsstutzen einpressen und das aufgebördelte Rohr an den Zwischenring andrücken. Überwurfmutter handfest anziehen. Überwurfmutter mit dem Schlüssel anziehen bis der Zwischenring unverlierbar in den Stutzen gepresst ist. Bei Kraftanstieg die Überwurfmutter um ca. 1/4 Umdrehung weiter anziehen. Nach jedem Lösen der Verbindung ist der Wiederanzug ohne erhöhten Kraftaufwand vorzunehmen.

5. Stainless steel fittings must be lubricated at the thread (for example use Gleitmo 810 or High Tech Paste ASW 040 P; see category 12).

These are special lubricants for stainless steel fittings.

6. / 7. Press the adaptor into the coupling body and press flared tube onto the adaptor. Screw the nut on by hand. Tighten the nut with a spanner until the adaptor is pressed captively into the coupling body. When torque must be intensified, tighten the nut approx. 1/4 turn more. Each time the connection is detached, it must be retightened without any intensified torque.

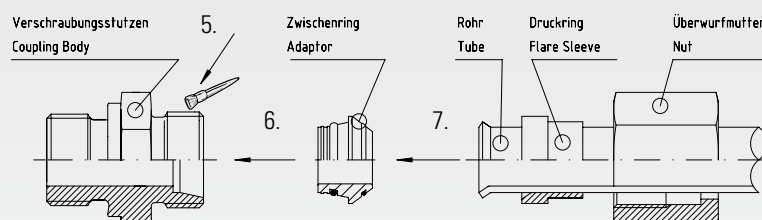

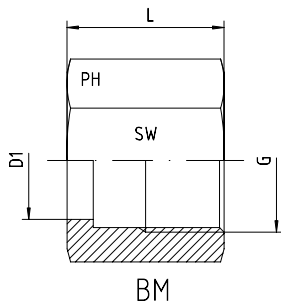

Überwurfmuttern

Für Bördelverschraubungen 37° und Verschraubungsstutzen mit 24°-Innenkonus
Bohrungsform W DIN 3861

Nuts

For Flare Couplings 37° and Coupling Bodies with 24°-Cone Type of Port End W DIN 3861

Reihe Series	Druck Pressure PN	Rohr A.D. Tube O.D. D1 + Tol.	Gewinde Thread G	SW	L	Bestellzeichen Order-Code	Brutto-Preis Gross-Price Euro (€)
L	500	6	M 12 x 1,5	14	17,0	BM-06-L	2,43
L	500	8	M 14 x 1,5	17	18,0	BM-08-L	3,32
L	500	10	M 16 x 1,5	19	19,5	BM-10-L	3,58
L	400	12	M 18 x 1,5	22	20,5	BM-12-L	4,22
L	400	15	M 22 x 1,5	27	23,0	BM-15-L	5,68
L	400	18	M 26 x 1,5	32	23,0	BM-18-L	8,44
L	315	22	M 30 x 2	36	27,5	BM-22-L	11,25
L	250	28	M 36 x 2	41	27,5	BM-28-L	19,17
L	250	35	M 45 x 2	50	30,0	BM-35-L	28,07
L	250	42	M 52 x 2	60	34,0	BM-42-L	37,07

Reihe Series	Druck Pressure PN	Rohr A.D. Tube O.D. D1 + Tol.	Gewinde Thread G	SW	L	Bestellzeichen Order-Code	Brutto-Preis Gross-Price Euro (€)
S	800	6	M 14 x 1,5	17	18,0	BM-06-S	3,32
S	800	8	M 16 x 1,5	19	20,0	BM-08-S	3,83
S	800	10	M 18 x 1,5	22	20,5	BM-10-S	4,35
S	630	12	M 20 x 1,5	24	21,0	BM-12-S	4,60
S	630	14	M 22 x 1,5	27	23,0	BM-14-S	7,62
S	630	16	M 24 x 1,5	30	26,5	BM-16-S	7,80
S	420	20	M 30 x 2	36	27,5	BM-20-S	11,76
S	420	25	M 36 x 2	46	30,5	BM-25-S	21,73
S	420	30	M 42 x 2	50	32,0	BM-30-S	33,34
S	420 (1)	38	M 52 x 2	60	38,0	BM-38-S	41,42

(1) Bei Inanspruchnahme von 420 bar ist der sonst übliche Sicherheitsfaktor 4 auf 3 zu reduzieren.
(1) In the 420 bar section, the normal safety factor of 4:1 is reduced to 3:1.

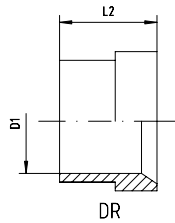

Druckringe

Für Bördelverschraubungen 37° und Verschraubungsstutzen mit 24°-Innenkonus
Bohrungsform W DIN 3861

Flare Sleeves

For Flare Couplings 37° and Coupling Bodies with 24°-Cone Type of Port End W DIN 3861

Reihe Series	Druck Pressure PN	Rohr A.D. Tube O.D. D1 + Tol.	L2	Bestellzeichen Order-Code	Brutto-Preis Gross-Price Euro (€)
L	500	6	10,5	DR-06-L	2,10
L	500	8	11,0	DR-08-L	2,43
L	500	10	12,5	DR-10-L	2,68
L	400	12	13,0	DR-12-L	3,20
L	400	15	14,0	DR-15-L	3,71
L	400	18	14,5	DR-18-L	4,22
L	315	22	18,0	DR-22-L	4,47
L	250	28	17,0	DR-28-L	6,26
L	250	35	19,0	DR-35-L	12,19
L	250	42	21,0	DR-42-L	18,71

Reihe Series	Druck Pressure PN	Rohr A.D. Tube O.D. D1 + Tol.	L2	Bestellzeichen Order-Code	Brutto-Preis Gross-Price Euro (€)
S	800	6	10,5	DR-06-S	2,17
S	800	8	11,0	DR-08-S	2,43
S	800	10	12,5	DR-10-S	2,68
S	630	12	13,0	DR-12-S	3,20
S	630	14	14,5	DR-14-S	3,71
S	630	16	17,0	DR-16-S	3,83
S	420	20	17,5	DR-20-S	4,35
S	420	25	20,0	DR-25-S	6,65
S	420	30	21,5	DR-30-S	10,74
S	420 (1)	38	26,5	DR-38-S	21,47

(1) Bei Inanspruchnahme von 420 bar ist der sonst übliche Sicherheitsfaktor 4 auf 3 zu reduzieren.
(1) In the 420 bar section, the normal safety factor of 4:1 is reduced to 3:1.

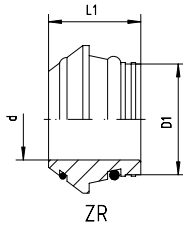

Zwischenringe mit O-Ring - NBR
 Viton - Auf Anfrage
 Für Bördelverschraubungen 37° und Verschraubungsstutzen
 mit 24°-Innenkonus
 Bohrungsform W DIN 3861

O-ring Adaptors - NBR
 Viton - On Request
 For Flare Couplings 37° and Coupling Bodies with 24°-Cone
 Type of Port End W DIN 3861

Reihe Series	Druck Pressure PN	Rohr A.D. Tube O.D. D1	d	L1	Bestellzeichen Order-Code	Brutto-Preis Gross-Price Euro (€)
L	500	6	3	11,5	ZR-06-L	6,95
L	500	8	5	12,0	ZR-08-L	8,39
L	500	10	6	12,5	ZR-10-L	8,39
L	400	12	8	12,5	ZR-12-L	8,95
L	400	15	11	12,5	ZR-15-L	10,76
L	400	18	14	13,0	ZR-18-L	12,17
L	315	22	17	14,2	ZR-22-L	13,73
L	250	28	23	14,7	ZR-28-L	15,47
L	250	35	28	18,5	ZR-35-L	22,68
L	250	42	35	20,5	ZR-42-L	28,25

Reihe Series	Druck Pressure PN	Rohr A.D. Tube O.D. D1	d	L1	Bestellzeichen Order-Code	Brutto-Preis Gross-Price Euro (€)
S	800	6	3	11,5	ZR-06-S	6,95
S	800	8	5	12,0	ZR-08-S	8,39
S	800	10	6	12,5	ZR-10-S	8,39
S	630	12	8	12,5	ZR-12-S	8,95
S	630	14	9	14,0	ZR-14-S	11,76
S	630	16	11	15,0	ZR-16-S	10,99
S	420	20	14	18,5	ZR-20-S	14,32
S	420	25	19	20,0	ZR-25-S	16,46
S	420	30	23	22,0	ZR-30-S	22,37
S	420 (1)	38	30	26,0	ZR-38-S	26,38

(1) Bei Inanspruchnahme von 420 bar ist der sonst übliche Sicherheitsfaktor 4 auf 3 zu reduzieren.
 (1) In the 420 bar section, the normal safety factor of 4:1 is reduced to 3:1.

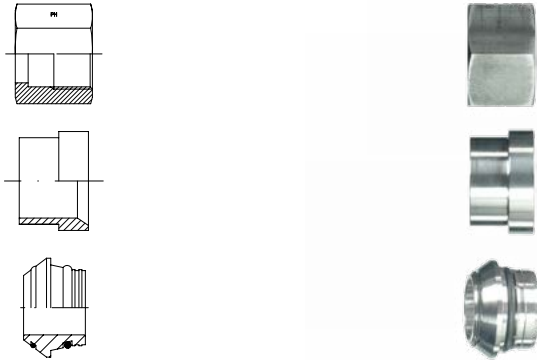

Anschlusssteile komplett
Für Bördelverschraubungen 37° und Verschraubungsstutzen
mit 24°-Innenkonus
Bohrungsform W DIN 3861

Complete Parts
For Flare Couplings 37° and Coupling Bodies with 24°-Cone
Type of Port End W DIN 3861

Reihe Series	Druck Pressure PN	Rohr A.D. Tube O.D. D1 + Tol.	Gewinde Thread G	L	L1	L2	d	SW	Bestellzeichen Order-Code	Brutto-Preis Gross-Price Euro (€)
L	500	6	M 12 x 1,5	17,0	11,5	10,5	3	14	BAN-06-L	11,48
L	500	8	M 14 x 1,5	18,0	12,0	11,0	5	17	BAN-08-L	14,14
L	500	10	M 16 x 1,5	19,5	12,5	12,5	6	19	BAN-10-L	14,65
L	400	12	M 18 x 1,5	20,5	12,5	13,0	8	22	BAN-12-L	16,36
L	400	15	M 22 x 1,5	23,0	12,5	14,0	11	27	BAN-15-L	20,15
L	400	18	M 26 x 1,5	23,0	13,0	14,5	14	32	BAN-18-L	24,82
L	315	22	M 30 x 2	27,5	14,2	18,0	17	36	BAN-22-L	29,45
L	250	28	M 36 x 2	27,5	14,7	17,0	23	41	BAN-28-L	40,90
L	250	35	M 45 x 2	30,0	18,5	19,0	28	50	BAN-35-L	62,94
L	250	42	M 52 x 2	34,0	20,5	21,0	35	60	BAN-42-L	84,03

Reihe Series	Druck Pressure PN	Rohr A.D. Tube O.D. D1 + Tol.	Gewinde Thread G	L	L1	L2	d	SW	Bestellzeichen Order-Code	Brutto-Preis Gross-Price Euro (€)
S	800	6	M 14 x 1,5	18,0	11,5	10,5	3	17	BAN-06-S	12,45
S	800	8	M 16 x 1,5	20,0	12,0	11,0	5	19	BAN-08-S	14,65
S	800	10	M 18 x 1,5	20,5	12,5	12,5	6	22	BAN-10-S	15,42
S	630	12	M 20 x 1,5	21,0	12,5	13,0	8	24	BAN-12-S	16,75
S	630	14	M 22 x 1,5	23,0	14,0	14,5	9	27	BAN-14-S	23,09
S	630	16	M 24 x 1,5	26,5	15,0	17,0	11	30	BAN-16-S	22,63
S	420	20	M 30 x 2	27,5	18,5	17,5	14	36	BAN-20-S	30,42
S	420	25	M 36 x 2	30,5	20,0	20,0	19	46	BAN-25-S	44,84
S	420	30	M 42 x 2	32,0	22,0	21,5	23	50	BAN-30-S	66,44
S	420 (1)	38	M 52 x 2	38,0	26,0	26,5	30	60	BAN-38-S	89,27

(1) Bei Inanspruchnahme von 420 bar ist der sonst übliche Sicherheitsfaktor 4 auf 3 zu reduzieren.
(1) In the 420 bar section, the normal safety factor of 4:1 is reduced to 3:1.













EDELSTAHL / STAINLESS STEEL
VERBINDUNGSTECHNIK
FLUID CONNECTORS

Schneidringverschraubungen Cone Sealing Couplings









SCHNEIDRINGVERSCHRAUBUNGEN NACH DIN 2353 / DIN EN ISO 8434-1

CONE SEALING COUPLINGS TO DIN 2353 / DIN EN ISO 8434-1

Produktgruppen	Product Groups	Seite Page
 <p>GV - Gerade Verschraubungen - LL-, L- und S-Reihe - GV - Gerade Verschraubungen - Standard - GV - Gerade Verschraubungen - SC - GV - Gerade Verschraubungsstutzen - OMD</p>	GV - Straight Couplings - LL-, L- und S-Reihe	
	- GV - Straight Couplings - Standard	8.10
	- GV - Straight Couplings - SC	8.11
	- GV - Straight Coupling Bodies - OMD	8.12
 <p>GRV - Verschraubungen - LL- und L-Reihe - GRV - Verschraubungen - Standard - GRV - Verschraubungen - SC - GRV - Verschraubungsstutzen - OMD</p> <p>GRV - Verschraubungen - S-Reihe - GRV - Verschraubungen - Standard - GRV - Verschraubungen - SC - GRV - Verschraubungsstutzen - OMD</p>	GRV - Stud Reducers - LL- and L-Series	
	- GRV - Stud Reducers - Standard	8.13
	- GRV - Stud Reducers - SC	8.14
	- GRV - Stud Reducer Coupling Bodies - OMD	8.15
	GRV - Stud Reducers - S-Series	
- GRV - Stud Reducers - Standard	8.16	
- GRV - Stud Reducers - SC	8.17	
- GRV - Stud Reducer Coupling Bodies - OMD	8.18	
 <p>WV - Winkel-Verschraubungen - LL-, L- und S-Reihe - WV - Winkel-Verschraubungen - Standard - WV - Winkel-Verschraubungen - SC - WV - Winkel-Verschraubungsstutzen - OMD</p>	WV - Equal Elbows - LL-, L- and S-Series	
	- WV - Equal Elbows - Standard	8.19
	- WV - Equal Elbows - SC	8.20
	- WV - Equal Elbow Bodies - OMD	8.21
 <p>TV - Verschraubungen - LL-, L- und S-Reihe - TV - Verschraubungen - Standard - TV - Verschraubungen - SC - TV - Verschraubungsstutzen - OMD</p>	TV - Equal Tees - LL-, L- and S-Series	
	- TV - Equal Tees - Standard	8.22
	- TV - Equal Tees - SC	8.23
	- TV - Equal Tee Bodies - OMD	8.24
 <p>TRV - Verschraubungen - S-Reihe - TRV - Verschraubungen - Standard - TRV - Verschraubungen - SC - TRV - Verschraubungsstutzen - OMD</p> <p>TRV - Verschraubungen - L-Reihe - TRV - Verschraubungen - Standard - TRV - Verschraubungen - SC - TRV - Verschraubungsstutzen - OMD</p>	TRV - Couplings - S-Series	
	- TRV - Couplings - Standard	8.25
	- TRV - Couplings - SC	8.26
	- TRV - Coupling Bodies - OMD	8.27
	TRV - Couplings - L-Series	
	- TRV - Couplings - Standard	8.28
- TRV - Couplings - SC	8.29	
- TRV - Coupling Bodies - OMD	8.30	
 <p>KV - Kreuz-Verschraubungen - LL-, L- und S-Reihe - KV - Kreuz-Verschraubungen - Standard - KV - Kreuz-Verschraubungen - SC - KV - Kreuzverschraubungsstutzen - OMD</p>	KV - Equal Crosses - LL-, L- and S-Series	
	- KV - Equal Crosses - Standard	8.31
	- KV - Equal Crosses - SC	8.32
	- KV - Equal Cross Bodies - OMD	8.33
 <p>GSV - Verschraubungen - LL-, L- und S-Reihe - GSV - Verschraubungen - Standard - GSV - Verschraubungen - SC - GSV - Verschraubungsstutzen - OMD</p>	GSV - Couplings - LL-, L- and S-Series	
	- GSV - Couplings - Standard	8.34
	- GSV - Couplings - SC	8.35
	- GSV - Coupling Bodies - OMD	8.36
 <p>WSV - Verschraubungen - L- und S-Reihe - WSV - Verschraubungen - Standard - WSV - Verschraubungen - SC - WSV - Verschraubungsstutzen - OMD</p>	WSV - Bulkhead Elbows - L- and S-Series	
	- WSV - Bulkhead Elbows - Standard	8.37
	- WSV - Bulkhead Elbows - SC	8.38
	- WSV - Bulkhead Elbow Bodies - OMD	8.39
 <p>GE - Verschraubungen - LL- und L-Reihe - Whitworth - Zylindrisch - B - Standard - Whitworth - Zylindrisch - B - SC - GE - Verschraubungsstutzen - Whitworth - Zylindrisch - B - OMD</p>	GE - Couplings - LL- and L-Series	
	- BSP - Parallel - B - Standard	8.40
	- BSP - Parallel - B - SC	8.41
	- GE - Coupling Bodies - BSP - Parallel - B - OMD	8.42
 <p>GE - Verschraubungen - LL- und L-Reihe - Whitworth - Zylindrisch - wd - Standard - Whitworth - Zylindrisch - wd - SC - GE - Verschraubungsstutzen - Whitworth - Zylindrisch - wd - OMD</p>	GE - Couplings - LL- and L-Series	
	- BSP - Parallel - wd - Standard	8.43
	- BSP - Parallel - wd - SC	8.44
	- GE - Coupling Bodies - BSP - Parallel - wd - OMD	8.45

Standard = Überwurfmutter blank / Tube nuts are supplied unplated
SC = Überwurfmutter bis Größe 12-S ist mit gleitbeschichtet / Tube nuts until size 12-L are supplied chemical plated
= Überwurfmutter ab Größe 12-S ist mit versilbertem Gewinde / Tube nuts from size 12-S are supplied with silver plated thread
OMD = Verschraubung ohne Überwurfmutter und Schneidring am Außengewinde / Couplings are supplied without nut and cutting ring at male thread



Produktgruppen	Product Groups	Seite Page
 <p>GE - Verschraubungen - S-Reihe - Whitworth - Zylindrisch - B - Standard - Whitworth - Zylindrisch - B - SC - GE - Verschraubungsstutzen - Whitworth - Zylindrisch - B - OMD</p>	<p>GE - Couplings - S-Series - BSP - Parallel - B - Standard - BSP - Parallel - B - SC - GE - Coupling Bodies - BSP - Parallel - B - OMD</p>	8.46
		8.47
		8.48
 <p>GE - Verschraubungen - S-Reihe - Whitworth - Zylindrisch - wd - Standard - Whitworth - Zylindrisch - wd - SC - GE - Verschraubungsstutzen - Whitworth - Zylindrisch - wd - OMD</p>	<p>GE - Couplings - S-Series - BSP - Parallel - wd - Standard - BSP - Parallel - wd - SC - GE - Coupling Bodies - BSP - Parallel - wd - OMD</p>	8.49
		8.50
		8.51
 <p>GE - Verschraubungen - L-Reihe - Metrisch - Zylindrisch - B - Standard - Metrisch - Zylindrisch - B - SC - GE - Verschraubungsstutzen - Metrisch - Zylindrisch - B - OMD</p> <p>GE - Verschraubungen - S-Reihe - Metrisch - Zylindrisch - B - Standard - Metrisch - Zylindrisch - B - SC - GE - Verschraubungsstutzen - Metrisch - Zylindrisch - B - OMD</p>	<p>GE - Couplings - L-Series - Metric - Parallel - B - Standard - Metric - Parallel - B - SC - GE - Coupling Bodies - Metric - Parallel - B - OMD</p> <p>GE - Couplings - S-Series - Metric - Parallel - B - Standard - Metric - Parallel - B - SC - GE - Coupling Bodies - Metric - Parallel - B - OMD</p>	8.52
		8.53
		8.54
		8.55
		8.56
		8.57
 <p>GE - Verschraubungen - LL- und L-Reihe - Metrisch - Zylindrisch - wd - Standard - Metrisch - Zylindrisch - wd - SC - GE - Verschraubungsstutzen - Metrisch - Zylindrisch - wd - OMD</p> <p>GE - Verschraubungen - S-Reihe - Metrisch - Zylindrisch - wd - Standard - Metrisch - Zylindrisch - wd - SC - GE - Verschraubungsstutzen - Metrisch - Zylindrisch - wd - OMD</p>	<p>GE - Couplings - LL- and L-Series - Metric - Parallel - wd - Standard - Metric - Parallel - wd - SC - GE - Coupling Bodies - Metric - Parallel - wd - OMD</p> <p>GE - Couplings - S-Series - Metric - Parallel - wd - Standard - Metric - Parallel - wd - SC - GE - Coupling Bodies - Metric - Parallel - wd - OMD</p>	8.58
		8.59
		8.60
		8.61
		8.62
		8.63
 <p>GE - Verschraubungen - LL- und L-Reihe - NPT - Standard - NPT - SC - GE - Verschraubungsstutzen - NPT - OMD</p> <p>GE - Verschraubungen - S-Reihe - NPT - Standard - NPT - SC - GE - Verschraubungsstutzen - NPT - OMD</p>	<p>GE - Couplings - LL- and L-Series - NPT - Standard - NPT - SC - GE - Coupling Bodies - NPT - OMD</p> <p>GE - Couplings - S-Series - NPT - Standard - NPT - SC - GE - Coupling Bodies - NPT - OMD</p>	8.64
		8.65
		8.66
		8.67
 <p>GE - Verschraubungen - LL- und L-Reihe - Whitworth - Kegelig - Standard - Whitworth - Kegelig - SC - GE - Verschraubungsstutzen - Whitworth - Kegelig - OMD</p> <p>GE - Verschraubungen - S-Reihe - Whitworth - Kegelig - Standard - Whitworth - Kegelig - SC - GE - Verschraubungsstutzen - Whitworth - Kegelig - OMD</p> <p>GE - Verschraubungen - LL- und L-Reihe - Metrisch - Kegelig - Standard - Metrisch - Kegelig - SC - GE - Verschraubungsstutzen - Metrisch - Kegelig - OMD</p>	<p>GE - Couplings - LL- and L-Series - BSP - Taper - Standard - BSP - Taper - SC - GE - Coupling Bodies - BSP - Taper - OMD</p> <p>GE - Couplings - S-Series - BSP - Taper - Standard - BSP - Taper - SC - GE - Coupling Bodies - BSP - Taper - OMD</p> <p>GE - Couplings - LL- and L-Series - Metric - Taper - Standard - Metric - Taper - SC - GE - Coupling Bodies - Metric - Taper - OMD</p>	8.70
		8.71
		8.72
		8.73
		8.74
		8.75
 <p>GE - Verschraubungen - L-Reihe - UNF - Standard - UNF - SC - GE - Verschraubungsstutzen - UNF - OMD</p> <p>GE - Verschraubungen - S-Reihe - UNF - Standard - UNF - SC - GE - Verschraubungsstutzen - UNF - OMD</p>	<p>GE - Couplings - L-Series - UNF - Standard - UNF - SC - GE - Coupling Bodies - UNF - OMD</p> <p>GE - Couplings - S-Series - UNF - Standard - UNF - SC - GE - Coupling Bodies - UNF - OMD</p>	8.79
		8.80
		8.81
		8.82
		8.83
		8.84











Standard = Überwurfmutter blank / Tube nuts are supplied unplated

SC = Überwurfmutter bis Größe 12-S ist ist gleitbeschichtet / Tube nuts until size 12-L are supplied chemical plated



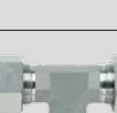







= Überwurfmutter ab Größe 12-S ist mit versilbertem Gewinde / Tube nuts from size 12-S are supplied with silver plated thread

OMD = Verschraubung ohne Überwurfmutter und Schneidring am Außengewinde / Couplings are supplied without nut and cutting ring at male thread





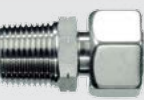

Produktgruppen	Product Groups	Seite Page
 WE - Verschraubungen - LL- und L-Reihe - Whitworth - Kegelig - Standard - Whitworth - Kegelig - SC - WE - Verschraubungsstutzen - Whitworth - Kegelig - OMD	WE - Couplings - LL- and L-Series - BSP - Taper - Standard - BSP - Taper - SC - WE - Coupling Bodies - BSP - Taper - OMD	8.85 8.86 8.87
 WE - Verschraubungen - S-Reihe - Whitworth - Kegelig - Standard - Whitworth - Kegelig - SC - WE - Verschraubungsstutzen - Whitworth - Kegelig - OMD	WE - Couplings - S-Series - BSP - Taper - Standard - BSP - Taper - SC - WE - Coupling Bodies - BSP - Taper - OMD	8.88 8.89 8.90
 WE - Verschraubungen - L- und S-Reihe - Whitworth - Zylindrisch - Standard - Whitworth - Zylindrisch - SC - WE - Verschraubungsstutzen - Whitworth - Zylindrisch - OMD	WE - Couplings - L- and S-Series - BSP - Parallel - Standard - BSP - Parallel - SC - WE - Coupling Bodies - BSP - Parallel - OMD	8.91 8.92 8.93
 WE - Verschraubungen - LL-, L und S-Reihe - Metrisch - Kegelig - Standard - Metrisch - Kegelig - SC - WE - Verschraubungsstutzen - Metrisch - Kegelig - OMD	WE - Couplings - LL-, L and S-Series - Metric - Taper - Standard - Metric - Taper - SC - WE - Coupling Bodies - Metric - Taper - OMD	8.94 8.95 9.96
 WE - Verschraubungen - L- und S-Reihe - Metrisch - Zylindrisch - Standard - Metrisch - Zylindrisch - SC - WE - Verschraubungsstutzen - Metrisch - Zylindrisch - OMD	WE - Couplings - L- and S-Series - Metric - Parallel - Standard - Metric - Parallel - SC - WE - Coupling Bodies - Metric - Parallel - OMD	8.97 8.98 8.99
 WE - Verschraubungen - LL- und L-Reihe - NPT - Standard - NPT - SC - WE - Verschraubungsstutzen - NPT - OMD	WE - Couplings - LL- and L-Series - NPT - Standard - NPT - SC - WE - Coupling Bodies - NPT - OMD	8.100 8.101 8.102
 WE - Verschraubungen - S-Reihe - NPT - Standard - NPT - SC - WE - Verschraubungsstutzen - NPT - OMD	WE - Couplings - S-Series - NPT - Standard - NPT - SC - WE - Coupling Bodies - NPT - OMD	8.103 8.104 8.105
 TE - Verschraubungen - LL-, L- und S-Reihe - Whitworth - Kegelig - Standard - Whitworth - Kegelig - SC - TE - Verschraubungsstutzen - Whitworth - Kegelig - OMD	TE - Couplings - LL-, L- and S-Series - BSP - Taper - Standard - BSP - Taper - SC - TE - Coupling Bodies - BSP - Taper - OMD	8.106 8.107 8.108
 TE - Verschraubungen - L- und S-Reihe - Whitworth - Zylindrisch - Standard - Whitworth - Zylindrisch - SC - TE - Verschraubungsstutzen - Whitworth - Zylindrisch - OMD	TE - Couplings - L- and S-Series - BSP - Parallel - Standard - BSP - Parallel - SC - TE - Coupling Bodies - BSP - Parallel - OMD	8.109 8.110 8.111
 TE - Verschraubungen - LL, L- und S-Reihe - Metrisch - Kegelig - Standard - Metrisch - Kegelig - SC - TE - Verschraubungsstutzen - Metrisch - Kegelig - OMD	TE - Couplings - LL, L- and S-Series - Metric - Taper - Standard - Metric - Taper - SC - TE - Coupling Bodies - Metric - Taper - OMD	8.112 8.113 8.114
 TE - Verschraubungen - L- und S-Reihe - Metrisch - Zylindrisch - Standard - Metrisch - Zylindrisch - SC - TE - Verschraubungsstutzen - Metrisch - Zylindrisch - OMD	TE - Couplings - L- and S-Series - Metric - Parallel - Standard - Metric - Parallel - SC - TE - Coupling Bodies - Metric - Parallel - OMD	8.115 8.116 8.117

Standard = Überwurfmutter blank / Tube nuts are supplied unplated
SC = Überwurfmutter bis Größe 12-S ist mit gleitbeschichtet / Tube nuts until size 12-L are supplied chemical plated
= Überwurfmutter ab Größe 12-S ist mit versilbertem Gewinde / Tube nuts from size 12-S are supplied with silver plated thread
OMD = Verschraubung ohne Überwurfmutter und Schneidring am Außengewinde / Couplings are supplied without nut and cutting ring at male thread

	Produktgruppen	Product Groups	Seite Page
	TE - Verschraubungen - LL, L- und S-Reihe - NPT - Standard - NPT - SC - TE - Verschraubungsstutzen - NPT - OMD	TE - Couplings - LL, L- and S-Series - NPT - Standard - NPT - SC - TE - Coupling Bodies - NPT - OMD	8.118 8.119 8.120
	LE - Verschraubungen - LL-, L- und S-Reihe - Whitworth - Kegelig - Standard - Whitworth - Kegelig - SC - LE - Verschraubungsstutzen - Whitworth - Kegelig - OMD	LE - Couplings - LL-, L- and S-Series - BSP - Taper - Standard - BSP - Taper - SC - LE - Coupling Bodies - BSP - Taper - OMD	8.121 8.122 8.123
	LE - Verschraubungen - L- und S-Reihe - Whitworth - Zylindrisch - Standard - Whitworth - Zylindrisch - SC - LE - Verschraubungsstutzen - Whitworth - Zylindrisch - OMD	LE - Couplings - L- and S-Series - BSP - Parallel - Standard - BSP - Parallel - SC - LE - Coupling Bodies - BSP - Parallel - OMD	8.124 8.125 8.126
	LE - Verschraubungen - LL, L- und S-Reihe - Metrisch - Kegelig - Standard - Metrisch - Kegelig - SC - LE - Verschraubungsstutzen - Metrisch - Kegelig - OMD	LE - Couplings - LL, L- and S-Series - Metric - Taper - Standard - Metric - Taper - SC - LE - Coupling Bodies - Metric - Taper - OMD	8.127 8.128 8.129
	LE - Verschraubungen - L- und S-Reihe - Metrisch - Zylindrisch - Standard - Metrisch - Zylindrisch - SC - LE - Verschraubungsstutzen - Metrisch - Zylindrisch - OMD	LE - Couplings - L- and S-Series - Metric - Parallel - Standard - Metric - Parallel - SC - LE - Coupling Bodies - Metric - Parallel - OMD	8.130 8.131 8.132
	LE - Verschraubungen - LL, L- und S-Reihe - NPT - Standard - NPT - SC - LE - Verschraubungsstutzen - NPT - OMD	LE - Couplings - LL, L- and S-Series - NPT - Standard - NPT - SC - LE - Coupling Bodies - NPT - OMD	8.133 8.134 8.135
	Gerade Aufsteckstutzen - Whitworth - Zylindrisch - ov	Stud Standpipe Connectors - BSP - Parallel - ov	8.136
	Gerade Aufsteckstutzen - Whitworth - Zylindrisch - Vormontiert - Standard - Whitworth - Zylindrisch - Vormontiert - SC	Stud Standpipe Connectors - BSP - Parallel - Pre-Assembled - Standard - BSP - Parallel - Pre-Assembled - SC	8.137 8.138
	Gerade Aufsteckstutzen - NPT - ov	Stud Standpipe Connectors - NPT - ov	8.139
	Gerade Aufsteckstutzen - NPT - Vormontiert - Standard - NPT - Vormontiert - SC	Stud Standpipe Connectors - NPT - Pre-Assembled - Standard - NPT - Pre-Assembled - SC	8.140 8.141
	Gerade Aufsteckstutzen - Metrisch - Zylindrisch - ov	Stud Standpipe Connectors - Metric - Parallel - ov	8.142











Standard = Überwurfmutter blank / Tube nuts are supplied unplated
SC = Überwurfmutter bis Größe 12-S ist ist gleitbeschichtet / Tube nuts until size 12-L are supplied chemical plated
= Überwurfmutter ab Größe 12-S ist mit versilbertem Gewinde / Tube nuts from size 12-S are supplied with silver plated thread
OMD = Verschraubung ohne Überwurfmutter und Schneidring am Außengewinde / Couplings are supplied without nut and cutting ring at male thread



Produktgruppen	Product Groups	Seite Page
 <p>Gerade Aufsteckstutzen - Metrisch - Zylindrisch - Vormontiert - Standard - Metrisch - Zylindrisch - Vormontiert - SC</p>	<p>Stud Standpipe Connectors - Metric - Parallel - Pre-Assembled - Standard - Metric - Parallel - Pre-Assembled - SC</p>	8.143
		8.144
 <p>MV - Verschraubungen - Whitworth - Zylindrisch - Standard - Whitworth - Zylindrisch - SC - MV - Verschraubungsstutzen - Whitworth - Zylindrisch - OMD</p>	<p>MV - Gauge Couplings - BSP - Female - Parallel - Standard - BSP - Female - Parallel - SC - MV - Gauge Coupling Bodies - BSP - Female - Parallel - OMD</p>	8.145
		8.146
		8.147
 <p>MV - Verschraubungen - NPT - Standard - NPT - SC - MV - Verschraubungsstutzen - NPT - OMD</p>	<p>MV - Gauge Couplings - NPT - Standard - NPT - SC - MV - Gauge Coupling Bodies - NPT - OMD</p>	8.148
		8.149
		8.150
 <p>MV - Verschraubungen - Einstellbar - Whitworth - Zylindrisch - Standard - Whitworth - Zylindrisch - SC - MV - Verschraubungsstutzen - Whitworth - Zylindrisch - OMD</p>	<p>MV - Gauge Swivel Couplings - BSP - Female - Parallel - Standard - BSP - Female - Parallel - SC - MV - Gauge Swivel Coupling Bodies - BSP - Female - Parallel - OMD</p>	8.151
		8.152
		8.153
 <p>GAI - Verschraubungen - L- und S-Reihe - Whitworth - Zylindrisch - Innen - Standard - Whitworth - Zylindrisch - Innen - SC - GAI - Verschraubungsstutzen - Whitworth - Zylindrisch - Innen - OMD - Metrisch - Zylindrisch - Innen - Standard - Metrisch - Zylindrisch - Innen - SC - GAI - Verschraubungsstutzen - Metrisch - Zylindrisch - Innen - OMD</p>	<p>GAI - Female Stud Couplings - L- and S-Series - BSP - Parallel - Female - Standard - BSP - Parallel - Female - SC - GAI - Female Stud Coupling Bodies - BSP - Parallel - Female - OMD - Metric - Parallel - Female - Standard - Metric - Parallel - Female - SC - GAI - Female Stud Coupling Bodies - Metric - Parallel - Female - OMD</p>	8.154
		8.155
		8.156
		8.157
		8.158
		8.159
 <p>GAI - Verschraubungen - L- und S-Reihe - NPT - Innen - Standard - NPT - Innen - SC - GAI - Verschraubungsstutzen - NPT - Innen - OMD</p>	<p>GAI - Female Stud Couplings - L- and S-Series - NPT - Female - Standard - NPT - Female - SC - GAI - Female Stud Coupling Bodies - NPT - Female - OMD</p>	8.160
		8.161
		8.162
 <p>WHV - Verschraubungen - LL-, L- und S-Reihe - Whitworth - Zylindrisch - Standard - Whitworth - Zylindrisch - SC - Whitworth - Zylindrisch - OMD</p>	<p>WHV - Banjo Elbows - LL-, L- and S-Series - BSP - Parallel - Standard - BSP - Parallel - SC - BSP - Parallel - OMD</p>	8.163
		8.164
		8.165
 <p>WHV - Verschraubungen - LL-, L- und S-Reihe - Whitworth - Zylindrisch - WDS - Standard - Whitworth - Zylindrisch - WDS - SC - Whitworth - Zylindrisch - WDS - OMD</p>	<p>WHV - Banjo Elbows - LL-, L- and S-Series - BSP - Parallel - WDS - Standard - BSP - Parallel - WDS - SC - BSP - Parallel - WDS - OMD</p>	8.166
		8.167
		8.168
 <p>WHV - Verschraubungen - LL-, L- und S-Reihe - Metrisch - Zylindrisch - Standard - Metrisch - Zylindrisch - SC - Metrisch - Zylindrisch - OMD</p>	<p>WHV - Banjo Elbows - LL-, L- and S-Series - Metric - Parallel - Standard - Metric - Parallel - SC - Metric - Parallel - OMD</p>	8.169
		8.170
		8.171
 <p>WHV - Verschraubungen - LL-, L- und S-Reihe - Metrisch - Zylindrisch - WDS - Standard - Metrisch - Zylindrisch - WDS - SC - Metrisch - Zylindrisch - WDS - OMD</p>	<p>WHV - Banjo Elbows - LL-, L- and S-Series - Metric - Parallel - WDS - Standard - Metric - Parallel - WDS - SC - Metric - Parallel - WDS - OMD</p>	8.172
		8.173
		8.174

Standard = Überwurfmutter blank / Tube nuts are supplied unplated
SC = Überwurfmutter bis Größe 12-S ist ist gleitbeschichtet / Tube nuts until size 12-L are supplied chemical plated
= Überwurfmutter ab Größe 12-S ist mit versilbertem Gewinde / Tube nuts from size 12-S are supplied with silver plated thread
OMD = Verschraubung ohne Überwurfmutter und Schneidring am Außengewinde / Couplings are supplied without nut and cutting ring at male thread



Produktgruppen	Product Groups	Seite Page	
	THV - Verschraubungen - LL-, L- und S-Reihe - Whitworth - Zylindrisch - Standard	THV - Banjo Tees - LL-, L- and S-Series - BSP - Parallel - Standard	8.175
	- Whitworth - Zylindrisch - SC	- BSP - Parallel - SC	8.176
	- Whitworth - Zylindrisch - OMD	- BSP - Parallel - OMD	8.177
	THV - Verschraubungen - LL-, L- und S-Reihe - Whitworth - Zylindrisch - WDS - Standard	THV - Banjo Tees - LL-, L- and S-Series - BSP - Parallel - WDS - Standard	8.178
	- Whitworth - Zylindrisch - WDS - SC	- BSP - Parallel - WDS - SC	8.179
	- Whitworth - Zylindrisch - WDS - OMD	- BSP - Parallel - WDS - OMD	8.180
	THV - Verschraubungen - LL-, L- und S-Reihe - Metrisch - Zylindrisch - Standard	THV - Banjo Tees - LL-, L- and S-Series - Metric - Parallel - Standard	8.181
	- Metrisch - Zylindrisch - SC	- Metric - Parallel - SC	8.182
	- Metrisch - Zylindrisch - OMD	- Metric - Parallel - OMD	8.183
	THV - Verschraubungen - LL-, L- und S-Reihe - Metrisch - Zylindrisch - WDS - Standard	THV - Banjo Tees - LL-, L- and S-Series - Metric - Parallel - WDS - Standard	8.184
	- Metrisch - Zylindrisch - WDS - SC	- Metric - Parallel - WDS - SC	8.185
	- Metrisch - Zylindrisch - WDS - OMD	- Metric - Parallel - WDS - OMD	8.186
	WEEV - Einstellbare Winkel-Verschraubungen - L- und S-Reihe - Whitworth - Zylindrisch - Standard	WEEV - Adjustable Elbow Couplings - L- and S-Series - BSP - Parallel - Standard	8.187
	- Whitworth - Zylindrisch - SC	- BSP - Parallel - SC	8.188
	- Whitworth - Zylindrisch - OMD	- BSP - Parallel - OMD	8.189
	EVW - Verschraubungen - L- und S-Reihe - Einstellbar - Vormontiert - Standard	EVW - Swivel Elbows - L- and S-Series - Male Stud Type - Pre-Assembled - Standard	8.190
	- Einstellbar - Vormontiert - SC	- Male Stud Type - Pre-Assembled - SC	8.191
	- Einstellbar - Vormontiert - OMD	- Male Stud Type - Pre-Assembled - OMD	8.192
	EVW - Verschraubungen - L- und S-Reihe - Whitworth - Zylindrisch - Vormontiert - Standard	EVW - Swivel Elbows - L- and S-Series - BSP - Parallel - Pre-Assembled - Standard	8.193
	- Whitworth - Zylindrisch - Vormontiert - SC	- BSP - Parallel - Pre-Assembled - SC	8.194
	- Whitworth - Zylindrisch - Vormontiert - OMD	- BSP - Parallel - Pre-Assembled - OMD	8.195
	- Metrisch - Zylindrisch - Vormontiert - Standard	- Metric - Parallel - Pre-Assembled - Standard	8.196
	- Metrisch - Zylindrisch - Vormontiert - SC	- Metric - Parallel - Pre-Assembled - SC	8.197
	- Metrisch - Zylindrisch - Vormontiert - OMD	- Metric - Parallel - Pre-Assembled - OMD	8.198
	EVT - Verschraubungen - L- und S-Reihe - Einstellbar - Vormontiert - Standard	EVT - Swivel Branch Tees - L- and S-Series - Male Stud Type - Pre-Assembled - Standard	8.199
	- Einstellbar - Vormontiert - SC	- Male Stud Type - Pre-Assembled - SC	8.200
	- Einstellbar - Vormontiert - OMD	- Male Stud Type - Pre-Assembled - OMD	8.201
	EVT - Verschraubungen - L- und S-Reihe - Whitworth - Zylindrisch - Vormontiert - Standard	EVT - Swivel Branch Tees - L- and S-Series - BSP - Parallel - Pre-Assembled - Standard	8.202
	- Whitworth - Zylindrisch - Vormontiert - SC	- BSP - Parallel - Pre-Assembled - SC	8.203
	- Whitworth - Zylindrisch - Vormontiert - OMD	- BSP - Parallel - Pre-Assembled - OMD	8.204
	EVT - Verschraubungen - L- und S-Reihe - Metrisch - Zylindrisch - Vormontiert - Standard	EVT - Swivel Branch Tees - L- and S-Series - Metric - Parallel - Pre-Assembled - Standard	8.205
	- Metrisch - Zylindrisch - Vormontiert - SC	- Metric - Parallel - Pre-Assembled - SC	8.206
	- Metrisch - Zylindrisch - Vormontiert - OMD	- Metric - Parallel - Pre-Assembled - OMD	8.207









Standard = Überwurfmutter blank / Tube nuts are supplied unplated

SC = Überwurfmutter bis Größe 12-S ist mit gleitbeschichtet / Tube nuts until size 12-L are supplied chemical plated

= Überwurfmutter ab Größe 12-S ist mit versilbertem Gewinde / Tube nuts from size 12-S are supplied with silver plated thread

OMD = Verschraubung ohne Überwurfmutter und Schneidring am Außengewinde / Couplings are supplied without nut and cutting ring at male thread



Produktgruppen	Product Groups	Seite Page
 <p>EVL - Verschraubungen - L- und S-Reihe</p> <ul style="list-style-type: none"> - Einstellbar - Vormontiert - Standard - Einstellbar - Vormontiert - SC - Einstellbar - Vormontiert - OMD 	<p>EVL - Swivel Barrel Tees - L- and S-Series</p> <ul style="list-style-type: none"> - Male Stud Type - Pre-Assembled - Standard - Male Stud Type - Pre-Assembled - SC - Male Stud Type - Pre-Assembled - OMD 	<p>8.208</p>
		<p>8.209</p>
		<p>8.210</p>
 <p>EVL - Verschraubungen - L- und S-Reihe</p> <ul style="list-style-type: none"> - Whitworth - Zylindrisch - Vormontiert - Standard - Whitworth - Zylindrisch - Vormontiert - SC - Whitworth - Zylindrisch - Vormontiert - OMD - Metrisch - Zylindrisch - Vormontiert - Standard - Metrisch - Zylindrisch - Vormontiert - SC - Metrisch - Zylindrisch - Vormontiert - OMD 	<p>EVL - Swivel Barrel Tees - L- and S-Series</p> <ul style="list-style-type: none"> - BSP - Parallel - Pre-Assembled - Standard - BSP - Parallel - Pre-Assembled - SC - BSP - Parallel - Pre-Assembled - OMD - Metric - Parallel - Pre-Assembled - Standard - Metric - Parallel - Pre-Assembled - SC - Metric - Parallel - Pre-Assembled - OMD 	<p>8.211</p>
		<p>8.212</p>
		<p>8.213</p>
		<p>8.214</p>
		<p>8.215</p>
		<p>8.216</p>
<p>Kegel-Rückschlagventile</p> <ul style="list-style-type: none"> - Beschreibung - Technische Daten / Durchflusswiderstände - Technische Daten / Durchflusswiderstände - Technische Daten / Durchflusswiderstände - Technische Daten / Durchflusswiderstände - Technische Daten / Durchflusswiderstände 	<p>Non-Return Valves</p> <ul style="list-style-type: none"> - Description - Technical Data / Pressure Drop - Technical Data / Pressure Drop - Technical Data / Pressure Drop - Technical Data / Pressure Drop - Technical Data / Pressure Drop 	<p>8.217</p>
		<p>8.218</p>
		<p>8.219</p>
		<p>8.220</p>
		<p>8.221</p>
 <p>Rückschlag-Durchgangsventile</p> <ul style="list-style-type: none"> - Innengewinde 	<p>Non-Return Valves</p> <ul style="list-style-type: none"> - Inside Thread 	<p>8.222</p>
		<p>8.223</p>
 <p>Einschraub-Rückschlagventile - L- und S-Reihe</p> <ul style="list-style-type: none"> - Metrisch - Zylindrisch - Standard - Metrisch - Zylindrisch - SC - Metrisch - Zylindrisch - OMD - Whitworth - Zylindrisch - Standard - Whitworth - Zylindrisch - SC - Whitworth - Zylindrisch - OMD 	<p>Non-Return Valves - L- and S-Series</p> <ul style="list-style-type: none"> - Metric - Parallel - Standard - Metric - Parallel - SC - Metric - Parallel - OMD - BSP - Parallel - Standard - BSP - Parallel - SC - BSP - Parallel - OMD 	<p>8.224</p>
		<p>8.225</p>
		<p>8.226</p>
		<p>8.227</p>
		<p>8.228</p>
		<p>8.229</p>
 <p>Einschraub-Rückschlagventile - L- und S-Reihe</p> <ul style="list-style-type: none"> - Metrisch - Zylindrisch - Standard - Metrisch - Zylindrisch - SC - Metrisch - Zylindrisch - OMD - Whitworth - Zylindrisch - Standard - Whitworth - Zylindrisch - SC - Whitworth - Zylindrisch - OMD 	<p>Non-Return Valves - L- and S-Series</p> <ul style="list-style-type: none"> - Metric - Parallel - Standard - Metric - Parallel - SC - Metric - Parallel - OMD - BSP - Parallel - Standard - BSP - Parallel - SC - BSP - Parallel - OMD 	<p>8.230</p>
		<p>8.231</p>
		<p>8.232</p>
		<p>8.233</p>
		<p>8.234</p>
		<p>8.235</p>
 <p>Rückschlag-Durchgangsventile - L- und S-Reihe</p> <ul style="list-style-type: none"> - Mit Schneidringanschluss - Standard - Mit Schneidringanschluss - SC - Mit Schneidringanschluss - OMD 	<p>Non-Return Valves - L- and S-Series</p> <ul style="list-style-type: none"> - With Tube Cutting Ring Connection - Standard - With Tube Cutting Ring Connection - SC - With Tube Cutting Ring Connection - OMD 	<p>8.236</p>
		<p>8.237</p>
		<p>8.238</p>
 <p>Konus-Reduzieranschlüsse - S-Reihe</p> <ul style="list-style-type: none"> - Standard - SC - OMD 	<p>Tube End Reducers - S-Series</p> <ul style="list-style-type: none"> - Standard - SC - OMD 	<p>8.239</p>
		<p>8.240</p>
		<p>8.241</p>
 <p>Konus-Reduzieranschlüsse - LL- und L-Reihe</p> <ul style="list-style-type: none"> - Standard - SC - OMD 	<p>Tube End Reducers - LL- and L-Series</p> <ul style="list-style-type: none"> - Standard - SC - OMD 	<p>8.242</p>
		<p>8.243</p>
		<p>8.244</p>
 <p>Gewinde-Reduzierungen</p> <ul style="list-style-type: none"> - Whitworth - Zylindrisch - Form A 	<p>Male/Female Stud Adaptors</p> <ul style="list-style-type: none"> - BSP - Parallel - Form A 	<p>8.245</p>
		<p>8.245</p>

Standard = Überwurfmutter blank / Tube nuts are supplied unplated
SC = Überwurfmutter bis Größe 12-S ist mit gleitbeschichtet / Tube nuts until size 12-L are supplied chemical plated
= Überwurfmutter ab Größe 12-S ist mit versilbertem Gewinde / Tube nuts from size 12-S are supplied with silver plated thread
OMD = Verschraubung ohne Überwurfmutter und Schneidring am Außengewinde / Couplings are supplied without nut and cutting ring at male thread



	Produktgruppen	Product Groups	Seite Page
	Gewinde-Reduzierungen - Whitworth - Zylindrisch - Form B	<i>Male/Female Stud Adaptors</i> - BSP - Parallel - Form B	8.246
	Gewinde-Reduzierungen - Whitworth - Zylindrisch - Mit Weichdichtung - Form A	<i>Male/Female Stud Adaptors</i> - BSP - Parallel - With Soft Sealing - Form A	8.247
	Gewinde-Reduzierungen - Whitworth - Zylindrisch - Mit Weichdichtung - Form B	<i>Male/Female Stud Adaptors</i> - BSP - Parallel - With Soft Sealing - Form B	8.248
	XROV - Verschlussstücke - L- und S-Reihe - für Rohrenden	<i>XROV - Blanking Plugs - L- and S-Series</i> - for Tube Ends	8.249
	VKA - Verschlusskegel - L- und S-Reihe - für Bohrungsform W DIN 3861	<i>VKA - Coupling Plugs - L- and S-Series</i> - for Port End W DIN 3861	8.250
	VST - Verschlusschrauben mit Innensechskant	<i>VST - Socket Head Port Plugs with Internal Hex</i>	8.251
	Verstärkungshülsen	<i>Reinforcing Rings</i>	8.252
	Gegenmuttern für Schottverschraubungen - Metrisch	<i>Locknuts for Bulkhead Couplings</i> - Metric	8.253
	Überwurfschrauben - DIN 3871	<i>Internal Coupling Nuts - DIN 3871</i>	8.254
	Kunststoffdichtringe - Für Schwenkverschraubungen WHV / THV	<i>PTFE - Seal Rings</i> - For Banjo Couplings WHV / THV	8.255
	Weichdichtringe - Für Einschraubgewinde / -löcher (breite / schmale Ausdehnung)	<i>Soft Seal Rings</i> - For Port Threads or wide and small Spot Faces of Ports	8.256



Standard = Überwurfmutter blank / Tube nuts are supplied unplated

SC = Überwurfmutter bis Größe 12-S ist mit gleitbeschichtet / Tube nuts until size 12-L are supplied chemical plated

= Überwurfmutter ab Größe 12-S ist mit versilbertem Gewinde / Tube nuts from size 12-S are supplied with silver plated thread

OMD = Verschraubung ohne Überwurfmutter und Schneidring am Außengewinde / Couplings are supplied without nut and cutting ring at male thread



	Produktgruppen	Product Groups	Seite Page
	Weichdichtringe für Schwenkverschraubungen WHV / THV - Für Einschraubgewinde / -löcher (breite / schmale Ausdrehung)	<i>Soft Seal Rings for Banjo Couplings WHV / THV - For Port Threads or wide and small Spot Faces of Ports</i>	8.257
	DKR - Dichtkantenringe für Außengewinde - WHV / THV	<i>DKR - Seal Edgerings for External Thread - WHV / THV</i>	8.258
	DKRI - Dichtkantenringe für Innengewinde	<i>DKRI - Seal Edgerings for Internal Thread</i>	8.259
	Weichdichtringe - WD (Viton) - DIN 3869	<i>Soft Seal Rings - WD (Viton) - DIN 3869</i>	8.260
	Flanschprofildichtungen für SAE J 518 / ISO 6162	<i>Profiled Flange Sealings for SAE J 518 / ISO 6162</i>	8.261
	Zweikanten-Schneidringe	<i>Double-Bite Cutting Rings</i>	8.262
	ES4-Zweikanten-Schneidringe mit Weichdichtung - Viton	<i>ES4-Double-Bite Cutting Rings with Soft-Seal - Viton</i>	8.263
	Überwurfmutter für Schneidringanschluss - LL-, L- und S-Reihe - Überwurfmutter für Schneidringanschluss - Standard - Überwurfmutter für Schneidringanschluss - SC	<i>Nuts for Cutting Ring Connections - LL-, L- and S-Series - Nuts for Cutting Ring Connections - Standard - Nuts for Cutting Ring Connections - SC</i>	8.264 8.265

Standard = Überwurfmutter blank / Tube nuts are supplied unplated
SC = Überwurfmutter bis Größe 12-S ist mit gleitbeschichtet / Tube nuts until size 12-L are supplied chemical plated
= Überwurfmutter ab Größe 12-S ist mit versilbertem Gewinde / Tube nuts from size 12-S are supplied with silver plated thread
OMD = Verschraubung ohne Überwurfmutter und Schneidring am Außengewinde / Couplings are supplied without nut and cutting ring at male thread

GV - GERADE VERSCHRAUBUNGEN

GV - STRAIGHT COUPLINGS

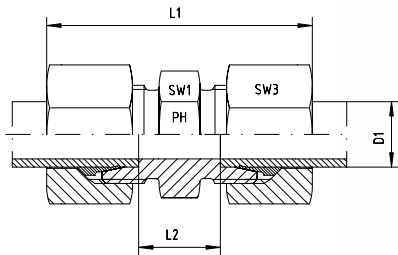

Reihe Series	Druck Pressure PN	Rohr A.D. Tube O.D. D1	Ca. Maße Approx. Dimensions				Bestellzeichen Order-Code Standard	Brutto-Preis Gross-Price Euro (€)
			L1	L2	SW1	SW3		
LL	100	4	35,0	12	9	10	GV-LL-04	11,04
LL	100	6	36,0	9	11	12	GV-LL-06	12,32
LL	100	8	38,5	12	12	14	GV-LL-08	13,63

Reihe Series	Druck Pressure PN	Rohr A.D. Tube O.D. D1	Ca. Maße Approx. Dimensions				Bestellzeichen Order-Code Standard	Brutto-Preis Gross-Price Euro (€)
			L1	L2	SW1	SW3		
L	500	6	44,0	10	12	14	GV-L-06	8,03
L	500	8	45,0	11	14	17	GV-L-08	10,02
L	500	10	48,0	13	17	19	GV-L-10	12,40
L	400	12	49,0	14	19	22	GV-L-12	14,24
L	400	15	54,0	16	24	27	GV-L-15	18,84
L	400	18	56,0	16	27	32	GV-L-18	28,12
L	250	22	63,0	20	32	36	GV-L-22	36,61
L	250	28	65,0	21	41	41	GV-L-28	58,08
L	250	35	74,0	20	46	50	GV-L-35	76,95
L	250	42	75,0	21	55	60	GV-L-42	104,97

Reihe Series	Druck Pressure PN	Rohr A.D. Tube O.D. D1	Ca. Maße Approx. Dimensions				Bestellzeichen Order-Code Standard	Brutto-Preis Gross-Price Euro (€)
			L1	L2	SW1	SW3		
S	800	6	50,0	16	14	17	GV-S-06	10,10
S	800	8	52,0	18	17	19	GV-S-08	11,96
S	800	10	54,0	17	19	22	GV-S-10	15,01
S	630	12	57,0	19	22	24	GV-S-12	16,77
S	630	14	63,0	22	24	27	GV-S-14	21,22
S	630	16	65,0	21	27	30	GV-S-16	27,99
S	420	20	73,0	23	32	36	GV-S-20	39,88
S	420	25	84,0	26	41	46	GV-S-25	66,37
S	420	30	88,0	27	46	50	GV-S-30	89,48
S	420	38	99,0	29	55	60	GV-S-38	120,16

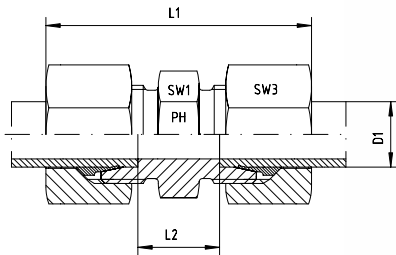

Reihe Series	Druck Pressure PN	Rohr A.D. Tube O.D. D1	Ca. Maße Approx. Dimensions				Bestellzeichen Order-Code SC	Brutto-Preis Gross-Price Euro (€)
			L1	L2	SW1	SW3		
L	500	6	44,0	10	12	14	GV-L-06-SC	8,67
L	500	8	45,0	11	14	17	GV-L-08-SC	10,90
L	500	10	48,0	13	17	19	GV-L-10-SC	13,28
L	400	12	49,0	14	19	22	GV-L-12-SC	15,36
L	400	15	54,0	16	24	27	GV-L-15-SC	21,00
L	400	18	56,0	16	27	32	GV-L-18-SC	31,40
L	250	22	63,0	20	32	36	GV-L-22-SC	40,13
L	250	28	65,0	21	41	41	GV-L-28-SC	62,08
L	250	35	74,0	20	46	50	GV-L-35-SC	84,39
L	250	42	75,0	21	55	60	GV-L-42-SC	113,61

Reihe Series	Druck Pressure PN	Rohr A.D. Tube O.D. D1	Ca. Maße Approx. Dimensions				Bestellzeichen Order-Code SC	Brutto-Preis Gross-Price Euro (€)
			L1	L2	SW1	SW3		
S	800	6	50,0	16	14	17	GV-S-06-SC	10,98
S	800	8	52,0	18	17	19	GV-S-08-SC	12,84
S	800	10	54,0	17	19	22	GV-S-10-SC	16,13
S	630	12	57,0	19	22	24	GV-S-12-SC	18,45
S	630	14	63,0	22	24	27	GV-S-14-SC	24,34
S	630	16	65,0	21	27	30	GV-S-16-SC	31,11
S	420	20	73,0	23	32	36	GV-S-20-SC	43,64
S	420	25	84,0	26	41	46	GV-S-25-SC	72,37
S	420	30	88,0	27	46	50	GV-S-30-SC	97,80
S	420	38	99,0	29	55	60	GV-S-38-SC	131,44

GV - GERADE
VERSCHRAUBUNGSTUTZEN
GV - STRAIGHT COUPLING BODIES



EDELSTAHL / STAINLESS STEEL
VERBINDUNGSTECHNIK
FLUID CONNECTORS



Reihe Series	Druck Pressure PN	Rohr A.D. Tube O.D. D1	Ca. Maße Approx. Dimensions				Bestellzeichen Order-Code OMD	Brutto-Preis Gross-Price Euro (€)
LL	100	4					GV-LL-04-OMD	5,72
LL	100	6					GV-LL-06-OMD	6,24
LL	100	8					GV-LL-08-OMD	6,63

Reihe Series	Druck Pressure PN	Rohr A.D. Tube O.D. D1	Ca. Maße Approx. Dimensions				Bestellzeichen Order-Code OMD	Brutto-Preis Gross-Price Euro (€)
L	500	6					GV-L-06-OMD	3,41
L	500	8					GV-L-08-OMD	4,42
L	500	10					GV-L-10-OMD	5,68
L	400	12					GV-L-12-OMD	6,46
L	400	15					GV-L-15-OMD	8,56
L	400	18					GV-L-18-OMD	10,88
L	250	22					GV-L-22-OMD	15,99
L	250	28					GV-L-28-OMD	28,38
L	250	35					GV-L-35-OMD	34,73
L	250	42					GV-L-42-OMD	50,11

Reihe Series	Druck Pressure PN	Rohr A.D. Tube O.D. D1	Ca. Maße Approx. Dimensions				Bestellzeichen Order-Code OMD	Brutto-Preis Gross-Price Euro (€)
S	800	6					GV-S-06-OMD	4,52
S	800	8					GV-S-08-OMD	5,56
S	800	10					GV-S-10-OMD	7,13
S	630	12					GV-S-12-OMD	7,87
S	630	14					GV-S-14-OMD	10,22
S	630	16					GV-S-16-OMD	11,57
S	420	20					GV-S-20-OMD	18,72
S	420	25					GV-S-25-OMD	29,13
S	420	30					GV-S-30-OMD	42,60
S	420	38					GV-S-38-OMD	56,88

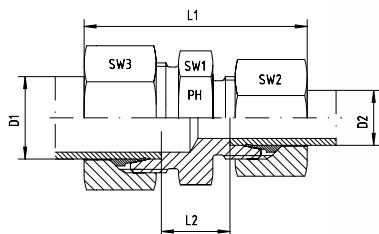

Gerade Reduzier-Verschraubungen
LL- und L-Reihe

Straight Reducer Couplings
LL- and L-Series

Reihe Series	Druck Pressure PN	Rohr A.D. Tube O.D.		Ca. Maße Approx. Dimensions					Bestellzeichen Order-Code Standard	Brutto-Preis Gross-Price Euro (€)
		D1	D2	L1	L2	SW1	SW2	SW3		
LL	100	6	4	36,0	10,5	11	10	12	GRV-LL-06/04	13,55
LL	100	8	6	38,0	11,0	12	12	14	GRV-LL-08/06	14,95

Reihe Series	Druck Pressure PN	Rohr A.D. Tube O.D.		Ca. Maße Approx. Dimensions					Bestellzeichen Order-Code Standard	Brutto-Preis Gross-Price Euro (€)
		D1	D2	L1	L2	SW1	SW2	SW3		
L	500	8	6	45,5	11,0	14	14	17	GRV-L-08/06	13,04
L	500	10	6	47,0	12,0	17	14	19	GRV-L-10/06	14,11
L	500	10	8	47,0	12,0	17	17	19	GRV-L-10/08	15,98
L	400	12	6	48,0	13,0	19	14	22	GRV-L-12/06	16,11
L	400	12	8	48,0	13,0	19	17	22	GRV-L-12/08	17,38
L	400	12	10	49,5	14,0	19	19	22	GRV-L-12/10	18,66
L	400	15	6	50,5	14,0	24	14	27	GRV-L-15/06	19,79
L	400	15	8	50,5	14,0	24	17	27	GRV-L-15/08	21,22
L	400	15	10	52,0	15,0	24	19	27	GRV-L-15/10	22,73
L	400	15	12	52,0	15,0	24	22	27	GRV-L-15/12	23,49
L	400	18	8	52,0	14,5	27	27	32	GRV-L-18/08	30,68
L	400	18	10	53,5	15,5	27	19	32	GRV-L-18/10	32,01
L	400	18	12	53,5	15,5	27	22	32	GRV-L-18/12	33,46
L	400	18	15	56,5	16,5	27	27	32	GRV-L-18/15	35,13
L	250	22	8	56,5	17,5	32	17	36	GRV-L-22/08	44,28
L	250	22	10	57,0	17,5	32	19	36	GRV-L-22/10	44,28
L	250	22	12	57,0	17,5	32	22	36	GRV-L-22/12	44,43
L	250	22	15	59,0	18,5	32	27	36	GRV-L-22/15	43,92
L	250	22	18	60,0	18,0	32	32	36	GRV-L-22/18	46,53
L	250	28	10	60,0	20,5	41	19	41	GRV-L-28/10	69,03
L	250	28	12	60,0	19,0	41	22	41	GRV-L-28/12	72,35
L	250	28	15	62,5	19,0	41	27	41	GRV-L-28/15	71,58
L	250	28	18	61,0	19,0	41	32	41	GRV-L-28/18	74,14
L	250	28	22	64,0	21,0	41	36	41	GRV-L-28/22	76,69
L	250	35	15			46	27	50	GRV-L-35/15	93,21
L	250	35	18	66,5	19,0	46	32	50	GRV-L-35/18	93,31
L	250	35	22	69,5	21,0	46	36	50	GRV-L-35/22	93,67
L	250	35	28	70,5	21,0	46	41	50	GRV-L-35/28	101,75
L	250	42	15	64,0	21,0	55	27	60	GRV-L-42/15	126,80
L	250	42	18		20,5	55	32	60	GRV-L-42/18	126,80
L	250	42	22	70,5	22,5	55	36	60	GRV-L-42/22	127,31
L	250	42	28	71,0	22,5	55	41	60	GRV-L-42/28	127,82
L	250	42	35	75,0	21,5	55	50	60	GRV-L-42/35	132,94

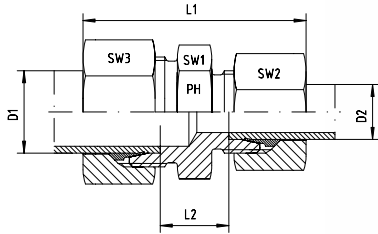

Gerade Reduzier-Verschraubungen
L-Reihe

Straight Reducer Couplings
L-Series

Reihe Series	Druck Pressure PN	Rohr A.D. Tube O.D.		Ca. Maße Approx. Dimensions					Bestellzeichen Order-Code SC	Brutto-Preis Gross-Price Euro (€)
		D1	D2	L1	L2	SW1	SW2	SW3		
L	500	8	6	45,5	11,0	14	14	17	GRV-L-08/06-SC	13,80
L	500	10	6	47,0	12,0	17	14	19	GRV-L-10/06-SC	14,87
L	500	10	8	47,0	12,0	17	17	19	GRV-L-10/08-SC	16,86
L	400	12	6	48,0	13,0	19	14	22	GRV-L-12/06-SC	16,99
L	400	12	8	48,0	13,0	19	17	22	GRV-L-12/08-SC	18,38
L	400	12	10	49,5	14,0	19	19	22	GRV-L-12/10-SC	19,66
L	400	15	6	50,5	14,0	24	14	27	GRV-L-15/06-SC	21,19
L	400	15	8	50,5	14,0	24	17	27	GRV-L-15/08-SC	22,74
L	400	15	10	52,0	15,0	24	19	27	GRV-L-15/10-SC	24,25
L	400	15	12	52,0	15,0	24	22	27	GRV-L-15/12-SC	25,13
L	400	18	8	52,0	14,5	27	27	32	GRV-L-18/08-SC	32,76
L	400	18	10	53,5	15,5	27	19	32	GRV-L-18/10-SC	34,09
L	400	18	12	53,5	15,5	27	22	32	GRV-L-18/12-SC	35,66
L	400	18	15	56,5	16,5	27	27	32	GRV-L-18/15-SC	37,85
L	250	22	8	56,5	17,5	32	17	36	GRV-L-22/08-SC	46,48
L	250	22	10	57,0	17,5	32	19	36	GRV-L-22/10-SC	46,48
L	250	22	12	57,0	17,5	32	22	36	GRV-L-22/12-SC	46,75
L	250	22	15	59,0	18,5	32	27	36	GRV-L-22/15-SC	46,76
L	250	22	18	60,0	18,0	32	32	36	GRV-L-22/18-SC	49,93
L	250	28	10	60,0	20,5	41	19	41	GRV-L-28/10-SC	71,47
L	250	28	12	60,0	19,0	41	22	41	GRV-L-28/12-SC	74,91
L	250	28	15	62,5	19,0	41	27	41	GRV-L-28/15-SC	74,66
L	250	28	18	61,0	19,0	41	32	41	GRV-L-28/18-SC	77,78
L	250	28	22	64,0	21,0	41	36	41	GRV-L-28/22-SC	80,45
L	250	35	15			46	27	50	GRV-L-35/15-SC	98,01
L	250	35	18	66,5	19,0	46	32	50	GRV-L-35/18-SC	98,67
L	250	35	22	69,5	21,0	46	36	50	GRV-L-35/22-SC	99,15
L	250	35	28	70,5	21,0	46	41	50	GRV-L-35/28-SC	107,47
L	250	42	15	64,0	21,0	55	27	60	GRV-L-42/15-SC	132,20
L	250	42	18		20,5	55	32	60	GRV-L-42/18-SC	132,76
L	250	42	22	70,5	22,5	55	36	60	GRV-L-42/22-SC	133,39
L	250	42	28	71,0	22,5	55	41	60	GRV-L-42/28-SC	134,14
L	250	42	35	75,0	21,5	55	50	60	GRV-L-42/35-SC	140,98

Gerade Reduzier-Verschraubungsstutzen
LL- und L-Reihe

Straight Reducer Coupling Bodies
LL- and L-Series



Reihe Series	Druck Pressure PN	Rohr A.D. Tube O.D.		Ca. Maße Approx. Dimensions				Bestellzeichen Order-Code OMD	Brutto-Preis Gross-Price Euro (€)
		D1	D2						
LL	100	6	4					GRV-LL-06/04-OMD	7,85
LL	100	8	6					GRV-LL-08/06-OMD	8,41

Reihe Series	Druck Pressure PN	Rohr A.D. Tube O.D.		Ca. Maße Approx. Dimensions				Bestellzeichen Order-Code OMD	Brutto-Preis Gross-Price Euro (€)
		D1	D2						
L	500	8	6					GRV-L-08/06-OMD	7,93
L	500	10	6					GRV-L-10/06-OMD	8,44
L	500	10	8					GRV-L-10/08-OMD	9,82
L	400	12	6					GRV-L-12/06-OMD	9,91
L	400	12	8					GRV-L-12/08-OMD	10,69
L	400	12	10					GRV-L-12/10-OMD	11,41
L	400	15	6					GRV-L-15/06-OMD	12,34
L	400	15	8					GRV-L-15/08-OMD	13,28
L	400	15	10					GRV-L-15/10-OMD	14,23
L	400	15	12					GRV-L-15/12-OMD	14,46
L	400	18	8					GRV-L-18/08-OMD	19,26
L	400	18	10					GRV-L-18/10-OMD	20,03
L	400	18	12					GRV-L-18/12-OMD	20,95
L	400	18	15					GRV-L-18/15-OMD	21,37
L	250	22	8					GRV-L-22/08-OMD	30,61
L	250	22	10					GRV-L-22/10-OMD	30,61
L	250	22	12					GRV-L-22/12-OMD	30,23
L	250	22	15					GRV-L-22/15-OMD	28,47
L	250	22	18					GRV-L-22/18-OMD	27,60
L	250	28	10					GRV-L-28/10-OMD	50,82
L	250	28	12					GRV-L-28/12-OMD	53,61
L	250	28	15					GRV-L-28/15-OMD	51,59
L	250	28	18					GRV-L-28/18-OMD	50,67
L	250	28	22					GRV-L-28/22-OMD	51,53
L	250	35	15					GRV-L-35/15-OMD	66,96
L	250	35	18					GRV-L-35/18-OMD	63,58
L	250	35	22					GRV-L-35/22-OMD	62,25
L	250	35	28					GRV-L-35/28-OMD	65,79
L	250	42	15					GRV-L-42/15-OMD	94,23
L	250	42	18					GRV-L-42/18-OMD	90,75
L	250	42	22					GRV-L-42/22-OMD	89,57
L	250	42	28					GRV-L-42/28-OMD	85,54
L	250	42	35					GRV-L-42/35-OMD	84,40

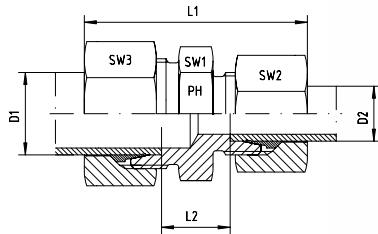

Gerade Reduzier-Verschraubungen
S-Reihe

Straight Reducer Couplings
S-Series

Reihe Series	Druck Pressure PN	Rohr A.D. Tube O.D.		Ca. Maße Approx. Dimensions					Bestellzeichen Order-Code Standard	Brutto-Preis Gross-Price Euro (€)
		D1	D2	L1	L2	SW1	SW2	SW3		
S	800	8	6	52,5	18,0	17	17	19	GRV-S-08/06	16,87
S	800	10	6	53,5	17,5	19	17	22	GRV-S-10/06	19,15
S	800	10	8	54,0	17,5	19	19	22	GRV-S-10/08	21,04
S	630	12	6	55,5	19,5	22	17	24	GRV-S-12/06	22,09
S	630	12	8	55,5	19,5	22	19	24	GRV-S-12/08	23,01
S	630	12	10	56,5	19,0	22	22	24	GRV-S-12/10	22,98
S	630	14	6			24	17	27	GRV-S-14/06	25,21
S	630	14	8			24	19	27	GRV-S-14/08	25,31
S	630	14	10	60,0	20,5	24	22	27	GRV-S-14/10	25,36
S	630	14	12	60,0	20,5	24	24	27	GRV-S-14/12	27,94
S	630	16	6	59,5	20,0	27	17	30	GRV-S-16/06	32,98
S	630	16	8	59,5	20,0	27	19	30	GRV-S-16/08	33,08
S	630	16	10	60,5	20,0	27	22	30	GRV-S-16/10	32,60
S	630	16	12	60,5	20,0	27	24	30	GRV-S-16/12	33,08
S	630	16	14	63,5	21,5	27	27	30	GRV-S-16/14	37,84
S	420	20	6	64,5	23,5	32	17	36	GRV-S-20/06	43,72
S	420	20	8	64,5	21,0	32	19	36	GRV-S-20/08	43,72
S	420	20	10	65,5	22,0	32	22	36	GRV-S-20/10	43,77
S	420	20	12	65,5	22,0	32	24	36	GRV-S-20/12	46,09
S	420	20	14	68,5	23,0	32	27	36	GRV-S-20/14	50,03
S	420	20	16	69,5	23,0	32	30	36	GRV-S-20/16	52,15
S	420	25	6			41	17	46	GRV-S-25/06	*
S	420	25	8	71,5	26,5	41	19	46	GRV-S-25/08	81,71
S	420	25	10	72,5	27,5	41	22	46	GRV-S-25/10	81,71
S	420	25	12	72,5	24,0	41	24	46	GRV-S-25/12	81,71
S	420	25	14	74,5	26,5	41	27	46	GRV-S-25/14	81,81
S	420	25	16	74,5	25,5	41	30	46	GRV-S-25/16	81,81
S	420	25	20	79,0	25,5	41	36	46	GRV-S-25/20	86,92
S	420	30	10	74,5	25,0	46	22	50	GRV-S-30/10	114,02
S	420	30	12	74,5	27,0	46	24	50	GRV-S-30/12	114,02
S	420	30	14			46	27	50	GRV-S-30/14	114,02
S	420	30	16	78,5	26,0	46	30	50	GRV-S-30/16	114,53
S	420	30	20	81,5	26,0	46	36	50	GRV-S-30/20	115,04
S	420	30	25	86,0	26,5	46	46	50	GRV-S-30/25	120,16
S	420	38	10	75,5	24,5	55	22	60	GRV-S-38/10	146,74
S	420	38	12			55	24	60	GRV-S-38/12	146,74
S	420	38	14			55	27	60	GRV-S-38/14	146,74
S	420	38	16	85,0	26,0	55	30	60	GRV-S-38/16	147,77
S	420	38	20	88,0	28,0	55	36	60	GRV-S-38/20	148,28
S	420	38	25	94,0	29,0	55	46	60	GRV-S-38/25	150,83
S	420	38	30	95,5	29,5	55	50	60	GRV-S-38/30	150,83

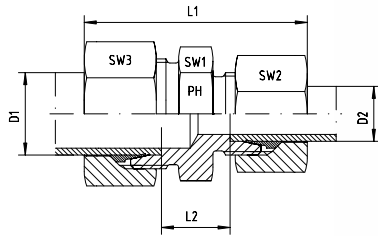

Gerade Reduzier-Verschraubungen
S-Reihe

Straight Reducer Couplings
S-Series

Reihe Series	Druck Pressure PN	Rohr A.D. Tube O.D.		Ca. Maße Approx. Dimensions					Bestellzeichen Order-Code SC	Brutto-Preis Gross-Price Euro (€)
		D1	D2	L1	L2	SW1	SW2	SW3		
S	800	8	6	52,5	18,0	17	17	19	GRV-S-08/06-SC	17,75
S	800	10	6	53,5	17,5	19	17	22	GRV-S-10/06-SC	20,15
S	800	10	8	54,0	17,5	19	19	22	GRV-S-10/08-SC	22,04
S	630	12	6	55,5	19,5	22	17	24	GRV-S-12/06-SC	23,37
S	630	12	8	55,5	19,5	22	19	24	GRV-S-12/08-SC	24,29
S	630	12	10	56,5	19,0	22	22	24	GRV-S-12/10-SC	24,38
S	630	14	6			24	17	27	GRV-S-14/06-SC	27,21
S	630	14	8			24	19	27	GRV-S-14/08-SC	27,31
S	630	14	10	60,0	20,5	24	22	27	GRV-S-14/10-SC	27,48
S	630	14	12	60,0	20,5	24	24	27	GRV-S-14/12-SC	30,34
S	630	16	6	59,5	20,0	27	17	30	GRV-S-16/06-SC	34,98
S	630	16	8	59,5	20,0	27	19	30	GRV-S-16/08-SC	35,08
S	630	16	10	60,5	20,0	27	22	30	GRV-S-16/10-SC	34,72
S	630	16	12	60,5	20,0	27	24	30	GRV-S-16/12-SC	35,48
S	630	16	14	63,5	21,5	27	27	30	GRV-S-16/14-SC	40,96
S	420	20	6	64,5	23,5	32	17	36	GRV-S-20/06-SC	46,04
S	420	20	8	64,5	21,0	32	19	36	GRV-S-20/08-SC	46,04
S	420	20	10	65,5	22,0	32	22	36	GRV-S-20/10-SC	46,21
S	420	20	12	65,5	22,0	32	24	36	GRV-S-20/12-SC	48,81
S	420	20	14	68,5	23,0	32	27	36	GRV-S-20/14-SC	53,47
S	420	20	16	69,5	23,0	32	30	36	GRV-S-20/16-SC	55,59
S	420	25	6			41	17	46	GRV-S-25/06-SC	*
S	420	25	8	71,5	26,5	41	19	46	GRV-S-25/08-SC	85,15
S	420	25	10	72,5	27,5	41	22	46	GRV-S-25/10-SC	85,27
S	420	25	12	72,5	24,0	41	24	46	GRV-S-25/12-SC	85,55
S	420	25	14	74,5	26,5	41	27	46	GRV-S-25/14-SC	86,37
S	420	25	16	74,5	25,5	41	30	46	GRV-S-25/16-SC	86,37
S	420	25	20	79,0	25,5	41	36	46	GRV-S-25/20-SC	91,80
S	420	30	10	74,5	25,0	46	22	50	GRV-S-30/10-SC	118,74
S	420	30	12	74,5	27,0	46	24	50	GRV-S-30/12-SC	119,02
S	420	30	14			46	27	50	GRV-S-30/14-SC	119,74
S	420	30	16	78,5	26,0	46	30	50	GRV-S-30/16-SC	120,25
S	420	30	20	81,5	26,0	46	36	50	GRV-S-30/20-SC	121,08
S	420	30	25	86,0	26,5	46	46	50	GRV-S-30/25-SC	127,32
S	420	38	10	75,5	24,5	55	22	60	GRV-S-38/10-SC	152,94
S	420	38	12			55	24	60	GRV-S-38/12-SC	153,22
S	420	38	14			55	27	60	GRV-S-38/14-SC	153,94
S	420	38	16	85,0	26,0	55	30	60	GRV-S-38/16-SC	154,97
S	420	38	20	88,0	28,0	55	36	60	GRV-S-38/20-SC	155,80
S	420	38	25	94,0	29,0	55	46	60	GRV-S-38/25-SC	159,47
S	420	38	30	95,5	29,5	55	50	60	GRV-S-38/30-SC	160,63

Gerade Reduzier-Verschraubungsstutzen
S-Reihe

*Straight Reducer Coupling Bodies
S-Series*



Reihe Series	Druck Pressure PN	Rohr A.D. Tube O.D.		Ca. Maße Approx. Dimensions				Bestellzeichen Order-Code OMD	Brutto-Preis Gross-Price Euro (€)
		D1	D2						
S	800	8	6					GRV-S-08/06-OMD	10,88
S	800	10	6					GRV-S-10/06-OMD	12,42
S	800	10	8					GRV-S-10/08-OMD	13,90
S	630	12	6					GRV-S-12/06-OMD	14,85
S	630	12	8					GRV-S-12/08-OMD	15,36
S	630	12	10					GRV-S-12/10-OMD	14,59
S	630	14	6					GRV-S-14/06-OMD	16,92
S	630	14	8					GRV-S-14/08-OMD	16,61
S	630	14	10					GRV-S-14/10-OMD	15,92
S	630	14	12					GRV-S-14/12-OMD	17,99
S	630	16	6					GRV-S-16/06-OMD	21,98
S	630	16	8					GRV-S-16/08-OMD	21,67
S	630	16	10					GRV-S-16/10-OMD	20,45
S	630	16	12					GRV-S-16/12-OMD	20,42
S	630	16	14					GRV-S-16/14-OMD	24,13
S	420	20	6					GRV-S-20/06-OMD	30,35
S	420	20	8					GRV-S-20/08-OMD	29,94
S	420	20	10					GRV-S-20/10-OMD	29,25
S	420	20	12					GRV-S-20/12-OMD	31,06
S	420	20	14					GRV-S-20/14-OMD	33,95
S	420	20	16					GRV-S-20/16-OMD	33,36
S	420	25	6					GRV-S-25/06-OMD	*
S	420	25	8					GRV-S-25/08-OMD	59,89
S	420	25	10					GRV-S-25/10-OMD	59,15
S	420	25	12					GRV-S-25/12-OMD	58,64
S	420	25	14					GRV-S-25/14-OMD	57,69
S	420	25	16					GRV-S-25/16-OMD	54,98
S	420	25	20					GRV-S-25/20-OMD	57,72
S	420	30	10					GRV-S-30/10-OMD	86,64
S	420	30	12					GRV-S-30/12-OMD	86,13
S	420	30	14					GRV-S-30/14-OMD	85,08
S	420	30	16					GRV-S-30/16-OMD	82,88
S	420	30	20					GRV-S-30/20-OMD	81,02
S	420	30	25					GRV-S-30/25-OMD	78,10
S	420	38	10					GRV-S-38/10-OMD	110,99
S	420	38	12					GRV-S-38/12-OMD	110,48
S	420	38	14					GRV-S-38/14-OMD	109,43
S	420	38	16					GRV-S-38/16-OMD	107,75
S	420	38	20					GRV-S-38/20-OMD	105,89
S	420	38	25					GRV-S-38/25-OMD	100,40
S	420	38	30					GRV-S-38/30-OMD	95,58



Reihe Series	Druck Pressure PN	Rohr A.D. Tube O.D. D1	Ca. Maße Approx. Dimensions				Bestellzeichen Order-Code Standard	Brutto-Preis Gross-Price Euro (€)
			L1	L2	SW2	SW3		
LL	100	4	21	11,0	9	10	WV-LL-04	19,17
LL	100	6	21	9,5	9	12	WV-LL-06	19,43
LL	100	8	23	11,5	12	14	WV-LL-08	20,84

Reihe Series	Druck Pressure PN	Rohr A.D. Tube O.D. D1	Ca. Maße Approx. Dimensions				Bestellzeichen Order-Code Standard	Brutto-Preis Gross-Price Euro (€)
			L1	L2	SW2	SW3		
L	500	6	27	12,0	12	14	WV-L-06	15,67
L	500	8	29	14,0	12	17	WV-L-08	16,44
L	500	10	30	15,0	14	19	WV-L-10	19,17
L	400	12	32	17,0	17	22	WV-L-12	21,99
L	400	15	36	21,0	19	27	WV-L-15	28,94
L	400	18	40	23,5	24	32	WV-L-18	41,47
L	250	22	44	27,5	27	36	WV-L-22	52,54
L	250	28	47	30,5	36	41	WV-L-28	97,15
L	250	35	56	34,5	41	50	WV-L-35	150,83
L	250	42	63	40,0	50	60	WV-L-42	237,75

Reihe Series	Druck Pressure PN	Rohr A.D. Tube O.D. D1	Ca. Maße Approx. Dimensions				Bestellzeichen Order-Code Standard	Brutto-Preis Gross-Price Euro (€)
			L1	L2	SW2	SW3		
S	800	6	31	16,0	12	17	WV-S-06	17,13
S	800	8	32	17,0	14	19	WV-S-08	19,69
S	800	10	34	17,5	17	22	WV-S-10	23,32
S	630	12	38	21,5	17	24	WV-S-12	26,51
S	630	14	40	22,0	19	27	WV-S-14	31,91
S	630	16	43	24,5	24	30	WV-S-16	41,88
S	420	20	48	26,5	27	36	WV-S-20	55,99
S	420	25	54	30,0	36	46	WV-S-25	107,37
S	420	30	62	35,5	41	50	WV-S-30	150,32
S	420	38	72	41,0	50	60	WV-S-38	230,08

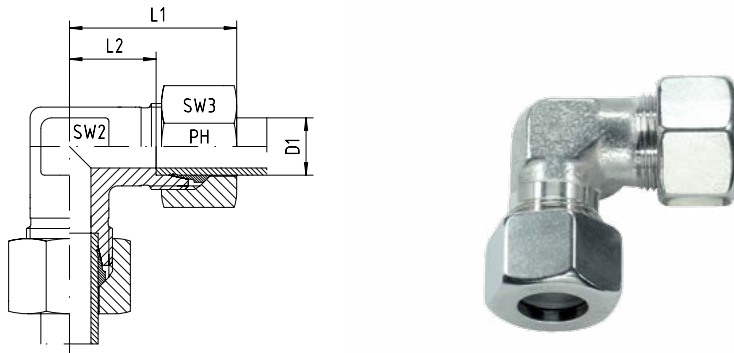

Reihe Series	Druck Pressure PN	Rohr A.D. Tube O.D. D1	Ca. Maße Approx. Dimensions				Bestellzeichen Order-Code SC	Brutto-Preis Gross-Price Euro (€)
			L1	L2	SW2	SW3		
L	500	6	27	12,0	12	14	WV-L-06-SC	16,31
L	500	8	29	14,0	12	17	WV-L-08-SC	17,32
L	500	10	30	15,0	14	19	WV-L-10-SC	20,05
L	400	12	32	17,0	17	22	WV-L-12-SC	23,11
L	400	15	36	21,0	19	27	WV-L-15-SC	31,10
L	400	18	40	23,5	24	32	WV-L-18-SC	44,75
L	250	22	44	27,5	27	36	WV-L-22-SC	56,06
L	250	28	47	30,5	36	41	WV-L-28-SC	101,15
L	250	35	56	34,5	41	50	WV-L-35-SC	158,27
L	250	42	63	40,0	50	60	WV-L-42-SC	246,39

Reihe Series	Druck Pressure PN	Rohr A.D. Tube O.D. D1	Ca. Maße Approx. Dimensions				Bestellzeichen Order-Code SC	Brutto-Preis Gross-Price Euro (€)
			L1	L2	SW2	SW3		
S	800	6	31	16,0	12	17	WV-S-06-SC	18,01
S	800	8	32	17,0	14	19	WV-S-08-SC	20,57
S	800	10	34	17,5	17	22	WV-S-10-SC	24,44
S	630	12	38	21,5	17	24	WV-S-12-SC	28,19
S	630	14	40	22,0	19	27	WV-S-14-SC	35,03
S	630	16	43	24,5	24	30	WV-S-16-SC	45,00
S	420	20	48	26,5	27	36	WV-S-20-SC	59,75
S	420	25	54	30,0	36	46	WV-S-25-SC	113,37
S	420	30	62	35,5	41	50	WV-S-30-SC	158,64
S	420	38	72	41,0	50	60	WV-S-38-SC	241,36



Reihe Series	Druck Pressure PN	Rohr A.D. Tube O.D. D1	Ca. Maße Approx. Dimensions				Bestellzeichen Order-Code OMD	Brutto-Preis Gross-Price Euro (€)
LL	100	4					WV-LL-04-OMD	13,85
LL	100	6					WV-LL-06-OMD	13,35
LL	100	8					WV-LL-08-OMD	13,84

Reihe Series	Druck Pressure PN	Rohr A.D. Tube O.D. D1	Ca. Maße Approx. Dimensions				Bestellzeichen Order-Code OMD	Brutto-Preis Gross-Price Euro (€)
L	500	6					WV-L-06-OMD	11,05
L	500	8					WV-L-08-OMD	10,84
L	500	10					WV-L-10-OMD	12,45
L	400	12					WV-L-12-OMD	14,21
L	400	15					WV-L-15-OMD	18,66
L	400	18					WV-L-18-OMD	24,23
L	250	22					WV-L-22-OMD	31,92
L	250	28					WV-L-28-OMD	67,45
L	250	35					WV-L-35-OMD	108,61
L	250	42					WV-L-42-OMD	182,89

Reihe Series	Druck Pressure PN	Rohr A.D. Tube O.D. D1	Ca. Maße Approx. Dimensions				Bestellzeichen Order-Code OMD	Brutto-Preis Gross-Price Euro (€)
S	800	6					WV-S-06-OMD	11,55
S	800	8					WV-S-08-OMD	13,29
S	800	10					WV-S-10-OMD	15,44
S	630	12					WV-S-12-OMD	17,61
S	630	14					WV-S-14-OMD	20,91
S	630	16					WV-S-16-OMD	25,46
S	420	20					WV-S-20-OMD	34,83
S	420	25					WV-S-25-OMD	70,13
S	420	30					WV-S-30-OMD	103,44
S	420	38					WV-S-38-OMD	166,80



Reihe Series	Druck Pressure PN	Rohr A.D. Tube O.D. D1	Ca. Maße Approx. Dimensions				Bestellzeichen Order-Code Standard	Brutto-Preis Gross-Price Euro (€)
			L1	L2	SW2	SW3		
LL	100	4	21	11,0	9	10	TV-LL-04	29,48
LL	100	6	21	9,5	9	12	TV-LL-06	31,11
LL	100	8	23	11,5	12	14	TV-LL-08	34,21

Reihe Series	Druck Pressure PN	Rohr A.D. Tube O.D. D1	Ca. Maße Approx. Dimensions				Bestellzeichen Order-Code Standard	Brutto-Preis Gross-Price Euro (€)
			L1	L2	SW2	SW3		
L	500	6	27	12,0	12	14	TV-L-06	21,63
L	500	8	29	14,0	12	17	TV-L-08	23,14
L	500	10	30	15,0	14	19	TV-L-10	26,69
L	400	12	32	17,0	17	22	TV-L-12	31,70
L	400	15	36	21,0	19	27	TV-L-15	45,05
L	400	18	40	23,5	24	32	TV-L-18	61,36
L	250	22	44	27,5	27	36	TV-L-22	86,82
L	250	28	47	30,5	36	41	TV-L-28	135,49
L	250	35	56	34,5	41	50	TV-L-35	232,64
L	250	42	63	40,0	50	60	TV-L-42	327,23

Reihe Series	Druck Pressure PN	Rohr A.D. Tube O.D. D1	Ca. Maße Approx. Dimensions				Bestellzeichen Order-Code Standard	Brutto-Preis Gross-Price Euro (€)
			L1	L2	SW2	SW3		
S	800	6	31	16,0	12	17	TV-S-06	23,67
S	800	8	32	17,0	14	19	TV-S-08	26,05
S	800	10	34	17,5	17	22	TV-S-10	32,21
S	630	12	38	21,5	17	24	TV-S-12	39,63
S	630	14	40	22,0	19	27	TV-S-14	43,72
S	630	16	43	24,4	24	30	TV-S-16	61,77
S	420	20	48	26,5	27	36	TV-S-20	87,94
S	420	25	54	30,0	36	46	TV-S-25	145,98
S	420	30	62	35,5	41	50	TV-S-30	220,11
S	420	38	72	41,0	50	60	TV-S-38	342,57



Reihe Series	Druck Pressure PN	Rohr A.D. Tube O.D. D1	Ca. Maße Approx. Dimensions				Bestellzeichen Order-Code SC	Brutto-Preis Gross-Price Euro (€)
			L1	L2	SW2	SW3		
L	500	6	27	12,0	12	14	TV-L-06-SC	22,59
L	500	8	29	14,0	12	17	TV-L-08-SC	24,46
L	500	10	30	15,0	14	19	TV-L-10-SC	28,01
L	400	12	32	17,0	17	22	TV-L-12-SC	33,38
L	400	15	36	21,0	19	27	TV-L-15-SC	48,29
L	400	18	40	23,5	24	32	TV-L-18-SC	66,28
L	250	22	44	27,5	27	36	TV-L-22-SC	92,10
L	250	28	47	30,5	36	41	TV-L-28-SC	141,49
L	250	35	56	34,5	41	50	TV-L-35-SC	243,80
L	250	42	63	40,0	50	60	TV-L-42-SC	340,19

Reihe Series	Druck Pressure PN	Rohr A.D. Tube O.D. D1	Ca. Maße Approx. Dimensions				Bestellzeichen Order-Code SC	Brutto-Preis Gross-Price Euro (€)
			L1	L2	SW2	SW3		
S	800	6	31	16,0	12	17	TV-S-06-SC	24,99
S	800	8	32	17,0	14	19	TV-S-08-SC	27,37
S	800	10	34	17,5	17	22	TV-S-10-SC	33,89
S	630	12	38	21,5	17	24	TV-S-12-SC	42,15
S	630	14	40	22,0	19	27	TV-S-14-SC	48,40
S	630	16	43	24,4	24	30	TV-S-16-SC	66,45
S	420	20	48	26,5	27	36	TV-S-20-SC	93,58
S	420	25	54	30,0	36	46	TV-S-25-SC	154,98
S	420	30	62	35,5	41	50	TV-S-30-SC	232,59
S	420	38	72	41,0	50	60	TV-S-38-SC	359,49

TV - VERSCHRAUBUNGSSTUTZEN

TV - EQUAL TEE BODIES



EDELSTAHL / STAINLESS STEEL
VERBINDUNGSTECHNIK
FLUID CONNECTORS



Reihe Series	Druck Pressure PN	Rohr A.D. Tube O.D. D1	Ca. Maße Approx. Dimensions				Bestellzeichen Order-Code OMD	Brutto-Preis Gross-Price Euro (€)
LL	100	4					TV-LL-04-OMD	21,50
LL	100	6					TV-LL-06-OMD	21,99
LL	100	8					TV-LL-08-OMD	23,71

Reihe Series	Druck Pressure PN	Rohr A.D. Tube O.D. D1	Ca. Maße Approx. Dimensions				Bestellzeichen Order-Code OMD	Brutto-Preis Gross-Price Euro (€)
L	500	6					TV-L-06-OMD	14,70
L	500	8					TV-L-08-OMD	14,74
L	500	10					TV-L-10-OMD	16,61
L	400	12					TV-L-12-OMD	20,03
L	400	15					TV-L-15-OMD	29,63
L	400	18					TV-L-18-OMD	35,50
L	250	22					TV-L-22-OMD	55,89
L	250	28					TV-L-28-OMD	90,94
L	250	35					TV-L-35-OMD	169,31
L	250	42					TV-L-42-OMD	244,94

Reihe Series	Druck Pressure PN	Rohr A.D. Tube O.D. D1	Ca. Maße Approx. Dimensions				Bestellzeichen Order-Code OMD	Brutto-Preis Gross-Price Euro (€)
S	800	6					TV-S-06-OMD	15,30
S	800	8					TV-S-08-OMD	16,45
S	800	10					TV-S-10-OMD	20,39
S	630	12					TV-S-12-OMD	26,28
S	630	14					TV-S-14-OMD	27,22
S	630	16					TV-S-16-OMD	37,14
S	420	20					TV-S-20-OMD	56,20
S	420	25					TV-S-25-OMD	90,12
S	420	30					TV-S-30-OMD	149,79
S	420	38					TV-S-38-OMD	247,14

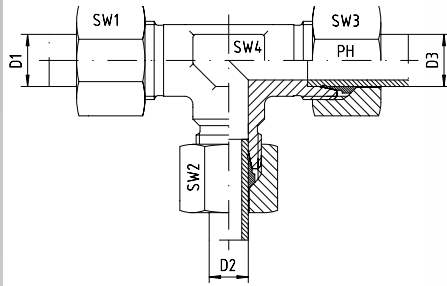

T-Reduzier-Verschraubungen
S-Reihe
Andere Sprunggrößen auf Anfrage!

*Reducing Tee Couplings
S-Series
Other jump sizes on request!*

Reihe Series	Druck Pressure PN	Rohr A.D. Tube O.D.			Ca. Maße Approx. Dimensions				Bestellzeichen Order-Code Standard	Brutto-Preis Gross-Price Euro (€)
		D1	D2	D3	SW1	SW2	SW3	SW4		
S	800	8	6	8	19	17	19	14	TRV-S-08/06/08	43,00
S	800	10	6	10	22	17	22	17	TRV-S-10/06/10	43,93
S	800	10	8	10	22	19	22	17	TRV-S-10/08/10	44,55
S	630	12	6	12	24	17	24	17	TRV-S-12/06/12	54,80
S	630	12	8	8	24	19	19	17	TRV-S-12/08/08	54,40
S	630	12	8	12	24	19	24	17	TRV-S-12/08/12	54,86
S	630	12	10	12	24	22	24	17	TRV-S-12/10/12	55,37
S	630	12	16	12	24	30	24	24	TRV-S-12/16/12	85,77
S	630	14	8	14	27	19	27	19	TRV-S-14/08/14	75,80
S	630	14	10	14	27	22	27	19	TRV-S-14/10/14	75,80
S	630	16	6	16	30	17	30	24	TRV-S-16/06/16	88,25
S	630	16	8	16	30	19	30	24	TRV-S-16/08/16	88,06
S	630	16	10	16	30	22	30	24	TRV-S-16/10/16	88,24
S	630	16	12	12	30	24	24	24	TRV-S-16/12/12	86,14
S	630	16	12	16	30	24	30	24	TRV-S-16/12/16	88,22
S	630	16	14	16	30	27	30	24	TRV-S-16/14/16	90,95
S	420	16	20	16	30	36	30	27	TRV-S-16/20/16	112,80
S	420	20	8	20	36	19	36	27	TRV-S-20/08/20	110,80
S	420	20	10	20	36	22	36	27	TRV-S-20/10/20	110,88
S	420	20	12	20	36	24	36	27	TRV-S-20/12/20	110,70
S	420	20	14	20	36	27	36	27	TRV-S-20/14/20	113,50
S	420	20	16	20	36	30	36	27	TRV-S-20/16/20	113,52
S	420	20	25	20	36	46	36	36	TRV-S-20/25/20	177,34
S	420	25	10	25	46	22	46	36	TRV-S-25/10/25	182,40
S	420	25	12	25	46	24	46	36	TRV-S-25/12/25	182,50
S	420	25	14	25	46	27	46	36	TRV-S-25/14/25	184,36
S	420	25	16	25	46	30	46	36	TRV-S-25/16/25	184,36
S	420	25	20	25	46	36	46	36	TRV-S-25/20/25	185,48
S	420	25	30	25	46	50	46	41	TRV-S-25/30/25	235,54
S	420	30	12	30	50	24	50	41	TRV-S-30/12/30	222,50
S	420	30	16	30	50	30	40	41	TRV-S-30/16/30	222,74
S	420	30	20	30	50	36	50	41	TRV-S-30/20/30	223,97
S	420	30	25	30	50	46	50	41	TRV-S-30/25/30	233,27
S	420	30	38	30	50	60	50	50	TRV-S-30/38/30	316,46
S	420	38	16	38	60	30	60	50	TRV-S-38/16/38	309,00
S	420	38	20	38	60	36	60	50	TRV-S-38/20/38	309,94
S	420	38	25	38	60	46	60	50	TRV-S-38/25/38	318,85
S	420	38	30	38	60	50	60	50	TRV-S-38/30/38	323,90

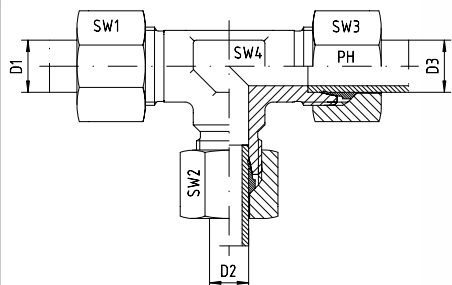

T-Reduzier-Verschraubungen
 S-Reihe
 Andere Sprunggrößen auf Anfrage!

*Reducing Tee Couplings
 S-Series
 Other jump sizes on request!*

Reihe Series	Druck Pressure PN	Rohr A.D. Tube O.D.			Ca. Maße Approx. Dimensions				Bestellzeichen Order-Code SC	Brutto-Preis Gross-Price Euro (€)
		D1	D2	D3	SW1	SW2	SW3	SW4		
S	800	8	6	8	19	17	19	14	TRV-S-08/06/08-SC	44,60
S	800	10	6	10	22	17	22	17	TRV-S-10/06/10-SC	45,49
S	800	10	8	10	22	19	22	17	TRV-S-10/08/10-SC	46,11
S	630	12	6	12	24	17	24	17	TRV-S-12/06/12-SC	56,92
S	630	12	8	8	24	19	19	17	TRV-S-12/08/08-SC	56,12
S	630	12	8	12	24	19	24	17	TRV-S-12/08/12-SC	56,98
S	630	12	10	12	24	22	24	17	TRV-S-12/10/12-SC	57,61
S	630	12	16	12	24	30	24	24	TRV-S-12/16/12-SC	89,01
S	630	14	8	14	27	19	27	19	TRV-S-14/08/14-SC	79,36
S	630	14	10	14	27	22	27	19	TRV-S-14/10/14-SC	79,48
S	630	16	6	16	30	17	30	24	TRV-S-16/06/16-SC	91,81
S	630	16	8	16	30	19	30	24	TRV-S-16/08/16-SC	91,62
S	630	16	10	16	30	22	30	24	TRV-S-16/10/16-SC	91,92
S	630	16	12	12	30	24	24	24	TRV-S-16/12/12-SC	90,10
S	630	16	12	16	30	24	30	24	TRV-S-16/12/16-SC	92,18
S	630	16	14	16	30	27	30	24	TRV-S-16/14/16-SC	95,63
S	420	16	20	16	30	36	30	27	TRV-S-16/20/16-SC	117,80
S	420	20	8	20	36	19	36	27	TRV-S-20/08/20-SC	115,00
S	420	20	10	20	36	22	36	27	TRV-S-20/10/20-SC	115,20
S	420	20	12	20	36	24	36	27	TRV-S-20/12/20-SC	115,30
S	420	20	14	20	36	27	36	27	TRV-S-20/14/20-SC	118,82
S	420	20	16	20	36	30	36	27	TRV-S-20/16/20-SC	118,84
S	420	20	25	20	36	46	36	36	TRV-S-20/25/20-SC	184,10
S	420	25	10	25	46	22	46	36	TRV-S-25/10/25-SC	188,96
S	420	25	12	25	46	24	46	36	TRV-S-25/12/25-SC	189,34
S	420	25	14	25	46	27	46	36	TRV-S-25/14/25-SC	191,92
S	420	25	16	25	46	30	46	36	TRV-S-25/16/25-SC	191,92
S	420	25	20	25	46	36	46	36	TRV-S-25/20/25-SC	193,36
S	420	25	30	25	46	50	46	41	TRV-S-25/30/25-SC	245,70
S	420	30	12	30	50	24	50	41	TRV-S-30/12/30-SC	231,66
S	420	30	16	30	50	30	40	41	TRV-S-30/16/30-SC	232,62
S	420	30	20	30	50	36	50	41	TRV-S-30/20/30-SC	234,17
S	420	30	25	30	50	46	50	41	TRV-S-30/25/30-SC	244,59
S	420	30	38	30	50	60	50	50	TRV-S-30/38/30-SC	330,42
S	420	38	16	38	60	30	60	50	TRV-S-38/16/38-SC	321,84
S	420	38	20	38	60	36	60	50	TRV-S-38/20/38-SC	323,10
S	420	38	25	38	60	46	60	50	TRV-S-38/25/38-SC	333,13
S	420	38	30	38	60	50	60	50	TRV-S-38/30/38-SC	339,34



T-Reduzier-Verschraubungsstutzen
S-Reihe
Andere Sprunggrößen auf Anfrage!

*Reducing Tee Coupling Bodies
S-Series
Other jump sizes on request!*

Reihe Series	Druck Pressure PN	Rohr A.D. Tube O.D.			Ca. Maße Approx. Dimensions				Bestellzeichen Order-Code OMD	Brutto-Preis Gross-Price Euro (€)
		D1	D2	D3						
S	800	8	6	8					TRV-S-08/06/08-OMD	33,81
S	800	10	6	10					TRV-S-10/06/10-OMD	33,26
S	800	10	8	10					TRV-S-10/08/10-OMD	33,47
S	630	12	6	12					TRV-S-12/06/12-OMD	43,11
S	630	12	8	8					TRV-S-12/08/08-OMD	43,55
S	630	12	8	12					TRV-S-12/08/12-OMD	42,76
S	630	12	10	12					TRV-S-12/10/12-OMD	42,53
S	630	12	16	12					TRV-S-12/16/12-OMD	68,66
S	630	14	8	14					TRV-S-14/08/14-OMD	61,60
S	630	14	10	14					TRV-S-14/10/14-OMD	60,86
S	630	16	6	16					TRV-S-16/06/16-OMD	69,04
S	630	16	8	16					TRV-S-16/08/16-OMD	68,44
S	630	16	10	16					TRV-S-16/10/16-OMD	67,88
S	630	16	12	12					TRV-S-16/12/12-OMD	69,03
S	630	16	12	16					TRV-S-16/12/16-OMD	67,35
S	630	16	14	16					TRV-S-16/14/16-OMD	69,03
S	420	16	20	16					TRV-S-16/20/16-OMD	85,80
S	420	20	8	20					TRV-S-20/08/20-OMD	86,44
S	420	20	10	20					TRV-S-20/10/20-OMD	85,78
S	420	20	12	20					TRV-S-20/12/20-OMD	85,09
S	420	20	14	20					TRV-S-20/14/20-OMD	86,84
S	420	20	16	20					TRV-S-20/16/20-OMD	84,15
S	420	20	25	20					TRV-S-20/25/20-OMD	137,56
S	420	25	10	25					TRV-S-25/10/25-OMD	141,22
S	420	25	12	25					TRV-S-25/12/25-OMD	140,81
S	420	25	14	25					TRV-S-25/14/25-OMD	141,62
S	420	25	16	25					TRV-S-25/16/25-OMD	138,91
S	420	25	20	25					TRV-S-25/20/25-OMD	137,66
S	420	25	30	25					TRV-S-25/30/25-OMD	174,86
S	420	30	12	30					TRV-S-30/12/30-OMD	171,17
S	420	30	16	30					TRV-S-30/16/30-OMD	167,65
S	420	30	20	30					TRV-S-30/20/30-OMD	166,51
S	420	30	25	30					TRV-S-30/25/30-OMD	167,77
S	420	30	38	30					TRV-S-30/38/30-OMD	237,77
S	420	38	16	38					TRV-S-38/16/38-OMD	237,51
S	420	38	20	38					TRV-S-38/20/38-OMD	236,08
S	420	38	25	38					TRV-S-38/25/38-OMD	236,95
S	420	38	30	38					TRV-S-38/30/38-OMD	237,18

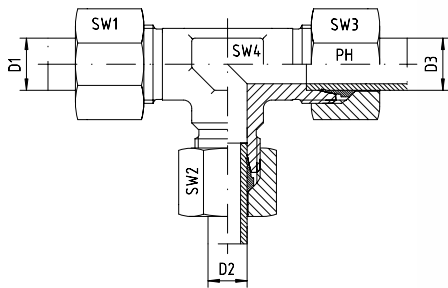

T-Reduzier-Verschraubungen
L-Reihe
Andere Sprunggrößen auf Anfrage!

Reducing Tee Couplings
L-Series
Other jump sizes on request!

Reihe Series	Druck Pressure PN	Rohr A.D. Tube O.D.			Ca. Maße Approx. Dimensions				Bestellzeichen Order-Code Standard	Brutto-Preis Gross-Price Euro (€)
		D1	D2	D3	SW1	SW2	SW3	SW4		
L	500	6	8	6	14	17	14	14	TRV-L-06/08/06	36,77
L	500	6	10	6	14	19	14	17	TRV-L-06/10/06	40,20
L	500	8	6	8	17	14	17	14	TRV-L-08/06/08	36,69
L	500	8	10	8	17	19	17	17	TRV-L-08/10/08	40,53
L	400	8	12	8	17	22	17	17	TRV-L-08/12/08	43,34
L	500	10	6	10	19	14	19	17	TRV-L-10/06/10	40,23
L	500	10	8	10	19	17	19	17	TRV-L-10/08/10	40,40
L	500	10	10	6	19	19	14	17	TRV-L-10/10/06	40,23
L	400	10	12	10	19	22	19	17	TRV-L-10/12/10	43,70
L	400	10	15	10	19	27	19	19	TRV-L-10/15/10	65,83
L	400	12	6	12	22	14	22	17	TRV-L-12/06/12	43,37
L	400	12	8	8	22	17	17	17	TRV-L-12/08/08	43,34
L	400	12	8	12	22	17	22	17	TRV-L-12/08/12	43,56
L	400	12	10	10	22	19	19	17	TRV-L-12/10/10	43,70
L	400	12	10	12	22	19	22	17	TRV-L-12/10/12	43,74
L	400	12	12	10	22	22	19	17	TRV-L-12/12/10	43,74
L	400	12	15	12	22	27	22	19	TRV-L-12/15/12	66,18
L	400	12	18	12	22	32	22	24	TRV-L-12/18/12	84,70
L	400	15	6	15	27	14	27	19	TRV-L-15/06/15	66,99
L	400	15	8	15	27	17	27	19	TRV-L-15/08/15	66,99
L	400	15	10	15	27	19	27	19	TRV-L-15/10/15	66,87
L	400	15	12	12	27	22	22	19	TRV-L-15/12/12	66,58
L	400	15	12	15	27	22	27	19	TRV-L-15/12/15	66,94
L	400	15	15	12	27	27	22	19	TRV-L-15/15/12	66,94
L	250	15	22	15	27	36	27	27	TRV-L-15/22/15	107,24
L	400	18	8	18	32	17	32	24	TRV-L-18/08/18	88,05
L	400	18	10	10	32	19	19	24	TRV-L-18/10/10	84,53
L	400	18	10	18	32	19	32	24	TRV-L-18/10/18	88,09
L	400	18	12	18	32	22	32	24	TRV-L-18/12/18	88,18
L	400	18	15	18	32	27	32	24	TRV-L-18/15/18	89,06
L	400	18	18	10	32	32	19	24	TRV-L-18/18/10	88,09
L	250	22	10	22	36	19	36	27	TRV-L-22/10/22	110,06
L	250	22	12	22	36	22	36	27	TRV-L-22/12/22	110,00
L	250	22	15	15	36	27	27	27	TRV-L-22/15/15	107,24
L	250	22	15	22	36	27	36	27	TRV-L-22/15/22	110,75
L	250	22	18	18	36	32	32	27	TRV-L-22/18/18	113,47
L	250	22	18	22	36	32	36	27	TRV-L-22/18/22	113,86
L	250	22	22	18	36	36	32	27	TRV-L-22/22/18	113,86
L	250	28	10	28	41	19	41	36	TRV-L-28/10/28	172,58
L	250	28	12	28	41	22	41	36	TRV-L-28/12/28	172,23
L	250	28	15	28	41	27	41	36	TRV-L-28/15/28	172,64
L	250	28	18	28	41	32	41	36	TRV-L-28/18/28	175,46
L	250	28	22	22	41	36	36	36	TRV-L-28/22/22	172,73
L	250	28	22	28	41	36	41	36	TRV-L-28/22/28	176,25
L	250	28	35	28	41	50	41	41	TRV-L-28/35/28	223,36
L	250	35	12	35	50	22	50	41	TRV-L-35/12/35	217,10
L	250	35	15	35	50	27	50	41	TRV-L-35/15/35	217,15
L	250	35	18	35	50	32	50	41	TRV-L-35/18/35	217,19
L	250	35	22	35	50	36	50	41	TRV-L-35/22/35	218,09
L	250	35	28	35	50	41	50	41	TRV-L-35/28/35	222,77
L	250	35	42	35	50	60	50	50	TRV-L-35/42/35	305,35
L	250	42	15	42	60	27	60	50	TRV-L-42/15/42	315,00
L	250	42	18	42	60	32	60	50	TRV-L-42/18/42	315,00
L	250	42	22	42	60	36	60	50	TRV-L-42/22/42	299,48
L	250	42	28	42	60	41	60	50	TRV-L-42/28/42	303,77
L	250	42	35	42	60	50	60	50	TRV-L-42/35/42	310,50

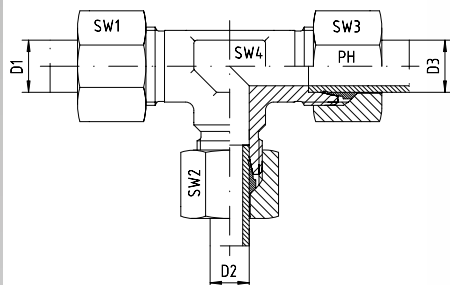

T-Reduzier-Verschraubungen
L-Reihe
Andere Sprunggrößen auf Anfrage!

Reducing Tee Couplings
L-Series
Other jump sizes on request!

Reihe Series	Druck Pressure PN	Rohr A.D. Tube O.D.			Ca. Maße Approx. Dimensions				Bestellzeichen Order-Code SC	Brutto-Preis Gross-Price Euro (€)
		D1	D2	D3	SW1	SW2	SW3	SW4		
L	500	6	8	6	14	17	14	14	TRV-L-06/08/06-SC	37,85
L	500	6	10	6	14	19	14	17	TRV-L-06/10/06-SC	41,28
L	500	8	6	8	17	14	17	14	TRV-L-08/06/08-SC	37,89
L	500	8	10	8	17	19	17	17	TRV-L-08/10/08-SC	41,85
L	400	8	12	8	17	22	17	17	TRV-L-08/12/08-SC	44,78
L	500	10	6	10	19	14	19	17	TRV-L-10/06/10-SC	41,43
L	500	10	8	10	19	17	19	17	TRV-L-10/08/10-SC	41,72
L	500	10	10	6	19	19	14	17	TRV-L-10/10/06-SC	41,43
L	400	10	12	10	19	22	19	17	TRV-L-10/12/10-SC	45,14
L	400	10	15	10	19	27	19	19	TRV-L-10/15/10-SC	67,79
L	400	12	6	12	22	14	22	17	TRV-L-12/06/12-SC	44,81
L	400	12	8	8	22	17	17	17	TRV-L-12/08/08-SC	44,78
L	400	12	8	12	22	17	22	17	TRV-L-12/08/12-SC	45,12
L	400	12	10	10	22	19	19	17	TRV-L-12/10/10-SC	45,14
L	400	12	10	12	22	19	22	17	TRV-L-12/10/12-SC	45,30
L	400	12	12	10	22	22	19	17	TRV-L-12/12/10-SC	45,30
L	400	12	15	12	22	27	22	19	TRV-L-12/15/12-SC	68,38
L	400	12	18	12	22	32	22	24	TRV-L-12/18/12-SC	87,46
L	400	15	6	15	27	14	27	19	TRV-L-15/06/15-SC	69,47
L	400	15	8	15	27	17	27	19	TRV-L-15/08/15-SC	69,59
L	400	15	10	15	27	19	27	19	TRV-L-15/10/15-SC	69,47
L	400	15	12	12	27	22	22	19	TRV-L-15/12/12-SC	68,78
L	400	15	12	15	27	22	27	19	TRV-L-15/12/15-SC	69,66
L	400	15	15	12	27	27	22	19	TRV-L-15/15/12-SC	69,66
L	250	15	22	15	27	36	27	27	TRV-L-15/22/15-SC	111,16
L	400	18	8	18	32	17	32	24	TRV-L-18/08/18-SC	91,77
L	400	18	10	10	32	19	19	24	TRV-L-18/10/10-SC	87,05
L	400	18	10	18	32	19	32	24	TRV-L-18/10/18-SC	91,81
L	400	18	12	18	32	22	32	24	TRV-L-18/12/18-SC	92,02
L	400	18	15	18	32	27	32	24	TRV-L-18/15/18-SC	93,42
L	400	18	18	10	32	32	19	24	TRV-L-18/18/10-SC	91,81
L	250	22	10	22	36	19	36	27	TRV-L-22/10/22-SC	114,02
L	250	22	12	22	36	22	36	27	TRV-L-22/12/22-SC	114,08
L	250	22	15	15	36	27	27	27	TRV-L-22/15/15-SC	111,16
L	250	22	15	22	36	27	36	27	TRV-L-22/15/22-SC	115,35
L	250	22	18	18	36	32	32	27	TRV-L-22/18/18-SC	118,51
L	250	22	18	22	36	32	36	27	TRV-L-22/18/22-SC	119,02
L	250	22	22	18	36	36	32	27	TRV-L-22/22/18-SC	119,02
L	250	28	10	28	41	19	41	36	TRV-L-28/10/28-SC	177,02
L	250	28	12	28	41	22	41	36	TRV-L-28/12/28-SC	176,79
L	250	28	15	28	41	27	41	36	TRV-L-28/15/28-SC	177,72
L	250	28	18	28	41	32	41	36	TRV-L-28/18/28-SC	181,10
L	250	28	22	22	41	36	36	36	TRV-L-28/22/22-SC	178,25
L	250	28	22	28	41	36	41	36	TRV-L-28/22/28-SC	182,01
L	250	28	35	28	41	50	41	41	TRV-L-28/35/28-SC	231,08
L	250	35	12	35	50	22	50	41	TRV-L-35/12/35-SC	225,10
L	250	35	15	35	50	27	50	41	TRV-L-35/15/35-SC	225,67
L	250	35	18	35	50	32	50	41	TRV-L-35/18/35-SC	226,27
L	250	35	22	35	50	36	50	41	TRV-L-35/22/35-SC	227,29
L	250	35	28	35	50	41	50	41	TRV-L-35/28/35-SC	232,21
L	250	35	42	35	50	60	50	50	TRV-L-35/42/35-SC	317,11
L	250	42	15	42	60	27	60	50	TRV-L-42/15/42-SC	324,72
L	250	42	18	42	60	32	60	50	TRV-L-42/18/42-SC	325,28
L	250	42	22	42	60	36	60	50	TRV-L-42/22/42-SC	309,88
L	250	42	28	42	60	41	60	50	TRV-L-42/28/42-SC	314,41
L	250	42	35	42	60	50	60	50	TRV-L-42/35/42-SC	322,86



T-Reduzier-Verschraubungsstutzen
L-Reihe
Andere Sprunggrößen auf Anfrage!

*Reducing Tee Coupling Bodies
L-Series
Other jump sizes on request!*

Reihe Series	Druck Pressure PN	Rohr A.D. Tube O.D.			Ca. Maße Approx. Dimensions			Bestellzeichen Order-Code OMD	Brutto-Preis Gross-Price Euro (€)
		D1	D2	D3					
L	500	6	8	6				TRV-L-06/08/06-OMD	29,35
L	500	6	10	6				TRV-L-06/10/06-OMD	32,22
L	500	8	6	8				TRV-L-08/06/08-OMD	28,78
L	500	8	10	8				TRV-L-08/10/08-OMD	31,57
L	400	8	12	8				TRV-L-08/12/08-OMD	33,85
L	500	10	6	10				TRV-L-10/06/10-OMD	31,20
L	500	10	8	10				TRV-L-10/08/10-OMD	30,88
L	500	10	10	6				TRV-L-10/10/06-OMD	31,20
L	400	10	12	10				TRV-L-10/12/10-OMD	33,09
L	400	10	15	10				TRV-L-10/15/10-OMD	53,97
L	400	12	6	12				TRV-L-12/06/12-OMD	33,28
L	400	12	8	8				TRV-L-12/08/08-OMD	33,85
L	400	12	8	12				TRV-L-12/08/12-OMD	32,98
L	400	12	10	10				TRV-L-12/10/10-OMD	33,09
L	400	12	10	12				TRV-L-12/10/12-OMD	32,60
L	400	12	12	10				TRV-L-12/12/10-OMD	32,60
L	400	12	15	12				TRV-L-12/15/12-OMD	53,26
L	400	12	18	12				TRV-L-12/18/12-OMD	68,30
L	400	15	6	15				TRV-L-15/06/15-OMD	54,40
L	400	15	8	15				TRV-L-15/08/15-OMD	53,91
L	400	15	10	15				TRV-L-15/10/15-OMD	53,23
L	400	15	12	12				TRV-L-15/12/12-OMD	53,66
L	400	15	12	15				TRV-L-15/12/15-OMD	52,77
L	400	15	15	12				TRV-L-15/15/12-OMD	52,77
L	250	15	22	15				TRV-L-15/22/15-OMD	86,65
L	400	18	8	18				TRV-L-18/08/18-OMD	68,01
L	400	18	10	10				TRV-L-18/10/10-OMD	69,19
L	400	18	10	18				TRV-L-18/10/18-OMD	67,49
L	400	18	12	18				TRV-L-18/12/18-OMD	67,05
L	400	18	15	18				TRV-L-18/15/18-OMD	66,68
L	400	18	18	10				TRV-L-18/18/10-OMD	67,49
L	250	22	10	22				TRV-L-22/10/22-OMD	86,08
L	250	22	12	22				TRV-L-22/12/22-OMD	85,49
L	250	22	15	15				TRV-L-22/15/15-OMD	86,65
L	250	22	15	22				TRV-L-22/15/22-OMD	84,99
L	250	22	18	18				TRV-L-22/18/18-OMD	85,92
L	250	22	18	22				TRV-L-22/18/22-OMD	84,62
L	250	22	22	18				TRV-L-22/22/18-OMD	84,62
L	250	28	10	28				TRV-L-28/10/28-OMD	139,52
L	250	28	12	28				TRV-L-28/12/28-OMD	138,64
L	250	28	15	28				TRV-L-28/15/28-OMD	137,80
L	250	28	18	28				TRV-L-28/18/28-OMD	137,14
L	250	28	22	22				TRV-L-28/22/22-OMD	137,26
L	250	28	22	28				TRV-L-28/22/28-OMD	136,24
L	250	28	35	28				TRV-L-28/35/28-OMD	172,55
L	250	35	12	35				TRV-L-35/12/35-OMD	170,99
L	250	35	15	35				TRV-L-35/15/35-OMD	169,79
L	250	35	18	35				TRV-L-35/18/35-OMD	166,35
L	250	35	22	35				TRV-L-35/22/35-OMD	165,56
L	250	35	28	35				TRV-L-35/28/35-OMD	165,70
L	250	35	42	35				TRV-L-35/42/35-OMD	235,70
L	250	42	15	42				TRV-L-42/15/42-OMD	255,00
L	250	42	18	42				TRV-L-42/18/42-OMD	251,52
L	250	42	22	42				TRV-L-42/22/42-OMD	234,31
L	250	42	28	42				TRV-L-42/28/42-OMD	234,06
L	250	42	35	42				TRV-L-42/35/42-OMD	234,53



Reihe Series	Druck Pressure PN	Rohr A.D. Tube O.D. D1	Ca. Maße Approx. Dimensions				Bestellzeichen Order-Code Standard	Brutto-Preis Gross-Price Euro (€)
			L1	L2	SW2	SW3		
LL	100	4	21	11,0	7	10	KV-LL-04	40,14
LL	100	6	21	9,5	9	12	KV-LL-06	40,14
LL	100	8	23	11,5	12	14	KV-LL-08	40,96

Reihe Series	Druck Pressure PN	Rohr A.D. Tube O.D. D1	Ca. Maße Approx. Dimensions				Bestellzeichen Order-Code Standard	Brutto-Preis Gross-Price Euro (€)
			L1	L2	SW2	SW3		
L	315	6	27	12,0	12	14	KV-L-06	40,60
L	315	8	29	14,0	12	17	KV-L-08	44,38
L	315	10	30	15,0	14	19	KV-L-10	56,75
L	315	12	32	17,0	17	22	KV-L-12	60,41
L	315	15	36	21,0	19	27	KV-L-15	77,77
L	315	18	40	23,5	24	32	KV-L-18	112,49
L	160	22	44	27,5	27	36	KV-L-22	151,34
L	160	28	47	30,5	36	41	KV-L-28	208,10
L	160	35	56	34,5	41	50	KV-L-35	268,43
L	160	42	63	40,0	50	60	KV-L-42	414,15

Reihe Series	Druck Pressure PN	Rohr A.D. Tube O.D. D1	Ca. Maße Approx. Dimensions				Bestellzeichen Order-Code Standard	Brutto-Preis Gross-Price Euro (€)
			L1	L2	SW2	SW3		
S	630	6	31	16,0	12	17	KV-S-06	44,99
S	630	8	32	17,0	14	19	KV-S-08	57,70
S	630	10	34	17,5	17	22	KV-S-10	63,91
S	630	12	38	21,5	17	24	KV-S-12	75,16
S	630	14	40	22,0	19	27	KV-S-14	79,25
S	400	16	43	24,5	24	30	KV-S-16	107,68
S	400	20	48	26,5	27	36	KV-S-20	149,81
S	400	25	54	30,0	36	46	KV-S-25	246,45
S	400	30	62	35,5	41	50	KV-S-30	271,50
S	315	38	72	41,0	50	60	KV-S-38	465,28



Reihe Series	Druck Pressure PN	Rohr A.D. Tube O.D. D1	Ca. Maße Approx. Dimensions				Bestellzeichen Order-Code SC	Brutto-Preis Gross-Price Euro (€)
			L1	L2	SW2	SW3		
L	315	6	27	12,0	12	14	KV-L-06-SC	41,88
L	315	8	29	14,0	12	17	KV-L-08-SC	46,14
L	315	10	30	15,0	14	19	KV-L-10-SC	58,51
L	315	12	32	17,0	17	22	KV-L-12-SC	62,65
L	315	15	36	21,0	19	27	KV-L-15-SC	82,09
L	315	18	40	23,5	24	32	KV-L-18-SC	119,05
L	160	22	44	27,5	27	36	KV-L-22-SC	158,38
L	160	28	47	30,5	36	41	KV-L-28-SC	216,10
L	160	35	56	34,5	41	50	KV-L-35-SC	283,31
L	160	42	63	40,0	50	60	KV-L-42-SC	431,43

Reihe Series	Druck Pressure PN	Rohr A.D. Tube O.D. D1	Ca. Maße Approx. Dimensions				Bestellzeichen Order-Code SC	Brutto-Preis Gross-Price Euro (€)
			L1	L2	SW2	SW3		
S	630	6	31	16,0	12	17	KV-S-06-SC	46,75
S	630	8	32	17,0	14	19	KV-S-08-SC	59,46
S	630	10	34	17,5	17	22	KV-S-10-SC	66,15
S	630	12	38	21,5	17	24	KV-S-12-SC	78,52
S	630	14	40	22,0	19	27	KV-S-14-SC	85,49
S	400	16	43	24,5	24	30	KV-S-16-SC	113,92
S	400	20	48	26,5	27	36	KV-S-20-SC	157,33
S	400	25	54	30,0	36	46	KV-S-25-SC	258,45
S	400	30	62	35,5	41	50	KV-S-30-SC	288,14
S	315	38	72	41,0	50	60	KV-S-38-SC	487,84



Reihe Series	Druck Pressure PN	Rohr A.D. Tube O.D. D1	Ca. Maße Approx. Dimensions				Bestellzeichen Order-Code OMD	Brutto-Preis Gross-Price Euro (€)
LL	100	4					KV-LL-04-OMD	29,50
LL	100	6					KV-LL-06-OMD	27,98
LL	100	8					KV-LL-08-OMD	26,96

Reihe Series	Druck Pressure PN	Rohr A.D. Tube O.D. D1	Ca. Maße Approx. Dimensions				Bestellzeichen Order-Code OMD	Brutto-Preis Gross-Price Euro (€)
L	315	6					KV-L-06-OMD	31,36
L	315	8					KV-L-08-OMD	33,18
L	315	10					KV-L-10-OMD	43,31
L	315	12					KV-L-12-OMD	44,85
L	315	15					KV-L-15-OMD	57,21
L	315	18					KV-L-18-OMD	78,01
L	160	22					KV-L-22-OMD	110,10
L	160	28					KV-L-28-OMD	148,70
L	160	35					KV-L-35-OMD	183,99
L	160	42					KV-L-42-OMD	304,43

Reihe Series	Druck Pressure PN	Rohr A.D. Tube O.D. D1	Ca. Maße Approx. Dimensions				Bestellzeichen Order-Code OMD	Brutto-Preis Gross-Price Euro (€)
S	630	6					KV-S-06-OMD	33,83
S	630	8					KV-S-08-OMD	44,90
S	630	10					KV-S-10-OMD	48,15
S	630	12					KV-S-12-OMD	57,36
S	630	14					KV-S-14-OMD	57,25
S	400	16					KV-S-16-OMD	74,84
S	400	20					KV-S-20-OMD	107,49
S	400	25					KV-S-25-OMD	171,97
S	400	30					KV-S-30-OMD	177,74
S	315	38					KV-S-38-OMD	338,04



Gerade Schottverschraubungen

Straight Bulkhead Connections

Reihe Series	Druck Pressure PN	Rohr A.D. Tube O.D. D1	Gewinde Thread G	Ca. Maße Approx. Dimensions							Bestellzeichen Order-Code Standard	Brutto-Preis Gross-Price Euro (€)
				L1	L2	L4	L5	SW1	SW3	SW4		
LL	100	4	M 8 x 1	19	7,0	23	11,0	11	10	11	GSV-LL-04	16,50
LL	100	6	M 10 x 1								GSV-LL-06	*
LL	100	8	M 12 x 1								GSV-LL-08	*

Reihe Series	Druck Pressure PN	Rohr A.D. Tube O.D. D1	Gewinde Thread G	Ca. Maße Approx. Dimensions							Bestellzeichen Order-Code Standard	Brutto-Preis Gross-Price Euro (€)
				L1	L2	L4	L5	SW1	SW3	SW4		
L	500	6	M 12 x 1,5	22	7,0	42	27,0	17	14	17	GSV-L-06	16,87
L	500	8	M 14 x 1,5	23	8,0	42	27,0	19	17	19	GSV-L-08	19,94
L	500	10	M 16 x 1,5	25	10,0	43	28,0	22	19	22	GSV-L-10	24,80
L	400	12	M 18 x 1,5	25	10,0	44	29,0	24	22	24	GSV-L-12	27,05
L	400	15	M 22 x 1,5	27	12,0	46	31,0	27	27	30	GSV-L-15	35,02
L	400	18	M 26 x 1,5	30	13,5	49	32,5	32	32	36	GSV-L-18	54,45
L	250	22	M 30 x 2	33	16,5	51	34,5	36	36	41	GSV-L-22	69,03
L	250	28	M 36 x 2	35	18,5	52	35,5	41	41	46	GSV-L-28	97,15
L	250	35	M 45 x 2	40	18,5	58	36,5	50	50	55	GSV-L-35	132,94
L	250	42	M 52 x 2	42	19,0	59	36,0	60	60	65	GSV-L-42	176,40

Reihe Series	Druck Pressure PN	Rohr A.D. Tube O.D. D1	Gewinde Thread G	Ca. Maße Approx. Dimensions							Bestellzeichen Order-Code Standard	Brutto-Preis Gross-Price Euro (€)
				L1	L2	L4	L5	SW1	SW3	SW4		
S	800	6	M 14 x 1,5	27	12,0	44	29,0	19	17	19	GSV-S-06	22,24
S	800	8	M 16 x 1,5	28	13,0	44	29,0	22	19	22	GSV-S-08	25,67
S	800	10	M 18 x 1,5	31	14,5	46	29,5	24	22	24	GSV-S-10	29,40
S	630	12	M 20 x 1,5	31	14,5	47	30,5	27	24	27	GSV-S-12	31,65
S	630	14	M 22 x 1,5	35	17,0	50	32,0	30	27	30	GSV-S-14	46,02
S	630	16	M 24 x 1,5	35	16,5	50	31,5	32	30	32	GSV-S-16	54,10
S	420	20	M 30 x 2	39	17,5	55	33,5	41	36	41	GSV-S-20	79,25
S	420	25	M 36 x 2	44	20,0	59	35,0	46	46	46	GSV-S-25	120,16
S	420	30	M 42 x 2	48	21,5	64	37,5	50	50	50	GSV-S-30	138,05
S	420	38	M 52 x 2	53	22,0	68	37,0	65	60	65	GSV-S-38	214,75



Gerade Schottverschraubungen

Straight Bulkhead Connections

Reihe Series	Druck Pressure PN	Rohr A.D. Tube O.D. D1	Gewinde Thread G	Ca. Maße Approx. Dimensions							Bestellzeichen Order-Code SC	Brutto-Preis Gross-Price Euro (€)
				L1	L2	L4	L5	SW1	SW3	SW4		
L	500	6	M 12 x 1,5	22	7,0	42	27,0	17	14	17	GSV-L-06-SC	17,51
L	500	8	M 14 x 1,5	23	8,0	42	27,0	19	17	19	GSV-L-08-SC	20,82
L	500	10	M 16 x 1,5	25	10,0	43	28,0	22	19	22	GSV-L-10-SC	25,68
L	400	12	M 18 x 1,5	25	10,0	44	29,0	24	22	24	GSV-L-12-SC	28,17
L	400	15	M 22 x 1,5	27	12,0	46	31,0	27	27	30	GSV-L-15-SC	37,18
L	400	18	M 26 x 1,5	30	13,5	49	32,5	32	32	36	GSV-L-18-SC	57,73
L	250	22	M 30 x 2	33	16,5	51	34,5	36	36	41	GSV-L-22-SC	72,55
L	250	28	M 36 x 2	35	18,5	52	35,5	41	41	46	GSV-L-28-SC	101,15
L	250	35	M 45 x 2	40	18,5	58	36,5	50	50	55	GSV-L-35-SC	140,38
L	250	42	M 52 x 2	42	19,0	59	36,0	60	60	65	GSV-L-42-SC	185,04

Reihe Series	Druck Pressure PN	Rohr A.D. Tube O.D. D1	Gewinde Thread G	Ca. Maße Approx. Dimensions							Bestellzeichen Order-Code SC	Brutto-Preis Gross-Price Euro (€)
				L1	L2	L4	L5	SW1	SW3	SW4		
S	800	6	M 14 x 1,5	27	12,0	44	29,0	19	17	19	GSV-S-06-SC	23,12
S	800	8	M 16 x 1,5	28	13,0	44	29,0	22	19	22	GSV-S-08-SC	26,55
S	800	10	M 18 x 1,5	31	14,5	46	29,5	24	22	24	GSV-S-10-SC	30,52
S	630	12	M 20 x 1,5	31	14,5	47	30,5	27	24	27	GSV-S-12-SC	33,33
S	630	14	M 22 x 1,5	35	17,0	50	32,0	30	27	30	GSV-S-14-SC	49,14
S	630	16	M 24 x 1,5	35	16,5	50	31,5	32	30	32	GSV-S-16-SC	57,22
S	420	20	M 30 x 2	39	17,5	55	33,5	41	36	41	GSV-S-20-SC	83,01
S	420	25	M 36 x 2	44	20,0	59	35,0	46	46	46	GSV-S-25-SC	126,16
S	420	30	M 42 x 2	48	21,5	64	37,5	50	50	50	GSV-S-30-SC	146,37
S	420	38	M 52 x 2	53	22,0	68	37,0	65	60	65	GSV-S-38-SC	226,03

Gerade Schottverschraubungsstutzen

Straight Bulkhead Connection Bodies



Reihe Series	Druck Pressure PN	Rohr A.D. Tube O.D. D1	Gewinde Thread G	Ca. Maße Approx. Dimensions						Bestellzeichen Order-Code OMD	Brutto-Preis Gross-Price Euro (€)
LL	100	4	M 8 x 1							GSV-LL-04-OMD	11,18
LL	100	6	M 10 x 1							GSV-LL-06-OMD	*
LL	100	8	M 12 x 1							GSV-LL-08-OMD	*

Reihe Series	Druck Pressure PN	Rohr A.D. Tube O.D. D1	Gewinde Thread G	Ca. Maße Approx. Dimensions						Bestellzeichen Order-Code OMD	Brutto-Preis Gross-Price Euro (€)
L	500	6	M 12 x 1,5							GSV-L-06-OMD	12,25
L	500	8	M 14 x 1,5							GSV-L-08-OMD	14,34
L	500	10	M 16 x 1,5							GSV-L-10-OMD	18,08
L	400	12	M 18 x 1,5							GSV-L-12-OMD	19,27
L	400	15	M 22 x 1,5							GSV-L-15-OMD	24,74
L	400	18	M 26 x 1,5							GSV-L-18-OMD	37,21
L	250	22	M 30 x 2							GSV-L-22-OMD	48,41
L	250	28	M 36 x 2							GSV-L-28-OMD	67,45
L	250	35	M 45 x 2							GSV-L-35-OMD	90,72
L	250	42	M 52 x 2							GSV-L-42-OMD	121,54

Reihe Series	Druck Pressure PN	Rohr A.D. Tube O.D. D1	Gewinde Thread G	Ca. Maße Approx. Dimensions						Bestellzeichen Order-Code OMD	Brutto-Preis Gross-Price Euro (€)
S	800	6	M 14 x 1,5							GSV-S-06-OMD	16,66
S	800	8	M 16 x 1,5							GSV-S-08-OMD	19,27
S	800	10	M 18 x 1,5							GSV-S-10-OMD	21,52
S	630	12	M 20 x 1,5							GSV-S-12-OMD	22,75
S	630	14	M 22 x 1,5							GSV-S-14-OMD	35,02
S	630	16	M 24 x 1,5							GSV-S-16-OMD	37,68
S	420	20	M 30 x 2							GSV-S-20-OMD	58,09
S	420	25	M 36 x 2							GSV-S-25-OMD	82,92
S	420	30	M 42 x 2							GSV-S-30-OMD	91,17
S	420	38	M 52 x 2							GSV-S-38-OMD	151,47

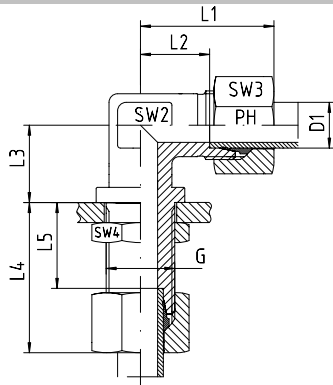

Winkel-Schottverschraubungen

Bulkhead Elbow Couplings

Reihe Series	Druck Pressure PN	Rohr A.D. Tube O.D. D1	Gewinde Thread G	Ca. Maße Approx. Dimensions								Bestellzeichen Order-Code Standard	Brutto-Preis Gross-Price Euro (€)
				L1	L2	L3	L4	L5	SW2	SW3	SW4		
L	315	6	M 12 x 1,5	27	12,0	14	42	27,0	12	14	17	WSV-L-06	31,19
L	315	8	M 14 x 1,5	29	14,0	17	42	27,0	12	17	19	WSV-L-08	34,26
L	315	10	M 16 x 1,5	30	15,0	18	43	28,0	14	19	22	WSV-L-10	40,03
L	315	12	M 18 x 1,5	32	17,0	20	44	29,0	17	22	24	WSV-L-12	43,79
L	315	15	M 22 x 1,5	36	21,0	23	46	31,0	19	27	30	WSV-L-15	57,52
L	315	18	M 26 x 1,5	40	23,5	24	49	32,5	24	32	36	WSV-L-18	76,69
L	160	22	M 30 x 2	44	27,5	30	51	34,5	27	36	41	WSV-L-22	104,82
L	160	28	M 36 x 2	47	30,5	34	52	35,5	36	41	46	WSV-L-28	145,72
L	160	35	M 45 x 2	56	34,5	39	58	36,5	41	50	55	WSV-L-35	204,52
L	160	42	M 52 x 2	63	40,0	43	59	36,0	50	60	65	WSV-L-42	299,11

Reihe Series	Druck Pressure PN	Rohr A.D. Tube O.D. D1	Gewinde Thread G	Ca. Maße Approx. Dimensions								Bestellzeichen Order-Code Standard	Brutto-Preis Gross-Price Euro (€)
				L1	L2	L3	L4	L5	SW2	SW3	SW4		
S	630	6	M 14 x 1,5	31	16,0	17	44	29,0	12	17	19	WSV-S-06	38,60
S	630	8	M 16 x 1,5	32	17,0	18	44	29,0	14	19	22	WSV-S-08	39,73
S	630	10	M 18 x 1,5	34	17,5	20	46	29,5	17	22	24	WSV-S-10	42,03
S	630	12	M 20 x 1,5	38	21,5	21	47	30,5	17	24	27	WSV-S-12	46,53
S	630	14	M 22 x 1,5	40	22,0	23	50	32,0	19	27	30	WSV-S-14	58,29
S	400	16	M 24 x 1,5	43	24,5	24	50	31,5	24	30	32	WSV-S-16	66,47
S	400	20	M 30 x 2	48	26,5	30	55	33,5	27	36	41	WSV-S-20	109,93
S	400	25	M 36 x 2	54	30,0	34	59	35,0	36	46	46	WSV-S-25	166,17
S	400	30	M 42 x 2	62	35,5	39	64	37,5	41	50	50	WSV-S-30	224,97
S	315	38	M 52 x 2	72	41,0	43	68	37,0	50	60	65	WSV-S-38	340,01

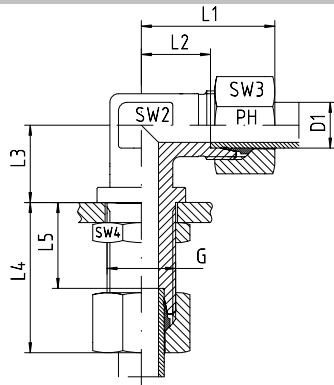

Winkel-Schottverschraubungen

Bulkhead Elbow Couplings

Reihe Series	Druck Pressure PN	Rohr A.D. Tube O.D. D1	Gewinde Thread G	Ca. Maße Approx. Dimensions								Bestellzeichen Order-Code SC	Brutto-Preis Gross-Price Euro (€)
				L1	L2	L3	L4	L5	SW2	SW3	SW4		
L	315	6	M 12 x 1,5	27	12,0	14	42	27,0	12	14	17	WSV-L-06-SC	31,83
L	315	8	M 14 x 1,5	29	14,0	17	42	27,0	12	17	19	WSV-L-08-SC	35,14
L	315	10	M 16 x 1,5	30	15,0	18	43	28,0	14	19	22	WSV-L-10-SC	40,91
L	315	12	M 18 x 1,5	32	17,0	20	44	29,0	17	22	24	WSV-L-12-SC	44,91
L	315	15	M 22 x 1,5	36	21,0	23	46	31,0	19	27	30	WSV-L-15-SC	59,68
L	315	18	M 26 x 1,5	40	23,5	24	49	32,5	24	32	36	WSV-L-18-SC	79,97
L	160	22	M 30 x 2	44	27,5	30	51	34,5	27	36	41	WSV-L-22-SC	108,34
L	160	28	M 36 x 2	47	30,5	34	52	35,5	36	41	46	WSV-L-28-SC	149,72
L	160	35	M 45 x 2	56	34,5	39	58	36,5	41	50	55	WSV-L-35-SC	211,96
L	160	42	M 52 x 2	63	40,0	43	59	36,0	50	60	65	WSV-L-42-SC	307,75

Reihe Series	Druck Pressure PN	Rohr A.D. Tube O.D. D1	Gewinde Thread G	Ca. Maße Approx. Dimensions								Bestellzeichen Order-Code SC	Brutto-Preis Gross-Price Euro (€)
				L1	L2	L3	L4	L5	SW2	SW3	SW4		
S	630	6	M 14 x 1,5	31	16,0	17	44	29,0	12	17	19	WSV-S-06-SC	39,48
S	630	8	M 16 x 1,5	32	17,0	18	44	29,0	14	19	22	WSV-S-08-SC	40,61
S	630	10	M 18 x 1,5	34	17,5	20	46	29,5	17	22	24	WSV-S-10-SC	43,15
S	630	12	M 20 x 1,5	38	21,5	21	47	30,5	17	24	27	WSV-S-12-SC	48,21
S	630	14	M 22 x 1,5	40	22,0	23	50	32,0	19	27	30	WSV-S-14-SC	61,41
S	400	16	M 24 x 1,5	43	24,5	24	50	31,5	24	30	32	WSV-S-16-SC	69,59
S	400	20	M 30 x 2	48	26,5	30	55	33,5	27	36	41	WSV-S-20-SC	113,69
S	400	25	M 36 x 2	54	30,0	34	59	35,0	36	46	46	WSV-S-25-SC	172,17
S	400	30	M 42 x 2	62	35,5	39	64	37,5	41	50	50	WSV-S-30-SC	233,29
S	315	38	M 52 x 2	72	41,0	43	68	37,0	50	60	65	WSV-S-38-SC	351,29



Winkel-Schottverschraubungsstutzen

Bulkhead Elbow Coupling Bodies

Reihe Series	Druck Pressure PN	Rohr A.D. Tube O.D. D1	Gewinde Thread G	Ca. Maße Approx. Dimensions						Bestellzeichen Order-Code OMD	Brutto-Preis Gross-Price Euro (€)
L	315	6	M 12 x 1,5							WSV-L-06-OMD	26,57
L	315	8	M 14 x 1,5							WSV-L-08-OMD	28,66
L	315	10	M 16 x 1,5							WSV-L-10-OMD	33,31
L	315	12	M 18 x 1,5							WSV-L-12-OMD	36,01
L	315	15	M 22 x 1,5							WSV-L-15-OMD	47,24
L	315	18	M 26 x 1,5							WSV-L-18-OMD	59,45
L	160	22	M 30 x 2							WSV-L-22-OMD	84,20
L	160	28	M 36 x 2							WSV-L-28-OMD	116,02
L	160	35	M 45 x 2							WSV-L-35-OMD	162,30
L	160	42	M 52 x 2							WSV-L-42-OMD	244,25

Reihe Series	Druck Pressure PN	Rohr A.D. Tube O.D. D1	Gewinde Thread G	Ca. Maße Approx. Dimensions						Bestellzeichen Order-Code OMD	Brutto-Preis Gross-Price Euro (€)
S	630	6	M 14 x 1,5							WSV-S-06-OMD	33,02
S	630	8	M 16 x 1,5							WSV-S-08-OMD	33,33
S	630	10	M 18 x 1,5							WSV-S-10-OMD	34,15
S	630	12	M 20 x 1,5							WSV-S-12-OMD	37,63
S	630	14	M 22 x 1,5							WSV-S-14-OMD	47,29
S	400	16	M 24 x 1,5							WSV-S-16-OMD	50,05
S	400	20	M 30 x 2							WSV-S-20-OMD	88,77
S	400	25	M 36 x 2							WSV-S-25-OMD	128,93
S	400	30	M 42 x 2							WSV-S-30-OMD	178,09
S	315	38	M 52 x 2							WSV-S-38-OMD	276,73

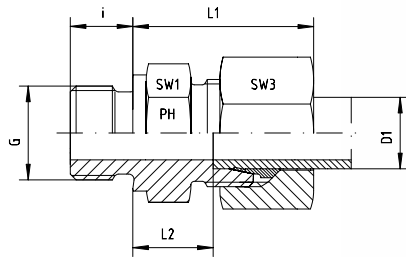

Gerade Einschraubverschraubungen

LL- und L-Reihe

Einschraubgewinde: Whitworth-Rohrgewinde - Zylindrisch
Abdichtung durch Dichtkante Form B

Male Stud Couplings

LL- and L-Series

Thread: BSP - Parallel

Sealing by Sealing Shoulder Form B

Reihe Series	Druck Pressure PN	Rohr A.D. Tube O.D. D1	Gewinde Thread G	Ca. Maße Approx. Dimensions					Bestellzeichen Order-Code Standard	Brutto-Preis Gross-Price Euro (€)
				L1	L2	i	SW1	SW3		
LL	100	4	G 1/8"	19,0	9,5	8	14	10	GE-LLR-04-G 1/8"	11,90
LL	100	6	G 1/8"	20,0	9,5	8	14	12	GE-LLR-06-G 1/8"	12,50
LL	100	8	G 1/8"		9,0	8	14	14	GE-LLR-08-G 1/8"	13,00

Reihe Series	Druck Pressure PN	Rohr A.D. Tube O.D. D1	Gewinde Thread G	Ca. Maße Approx. Dimensions					Bestellzeichen Order-Code Standard	Brutto-Preis Gross-Price Euro (€)
				L1	L2	i	SW1	SW3		
L	315	6	G 1/8"	23,0	8,5	8	14	14	GE-LR-06-G 1/8"	5,88
L	315	6	G 1/4"	27,0	9,0	12	19	14	GE-LR-06-G 1/4"	10,12
L	315	6	G 3/8"	27,0	11,5	12	22	14	GE-LR-06-G 3/8"	14,57
L	315	6	G 1/2"	29,0	12,0	14	27	14	GE-LR-06-G 1/2"	15,85
L	315	8	G 1/8"	26,0	9,5	8	14	17	GE-LR-08-G 1/8"	8,33
L	315	8	G 1/4"	25,0	10,0	12	19	17	GE-LR-08-G 1/4"	7,46
L	315	8	G 3/8"	28,5	11,5	12	22	17	GE-LR-08-G 3/8"	11,38
L	315	8	G 1/2"	28,5	13,0	14	27	17	GE-LR-08-G 1/2"	14,57
L	315	10	G 1/8"	27,5	11,0	8	17	19	GE-LR-10-G 1/8"	9,00
L	315	10	G 1/4"	26,0	11,0	12	19	19	GE-LR-10-G 1/4"	8,39
L	315	10	G 3/8"	30,5	12,5	12	22	19	GE-LR-10-G 3/8"	12,76
L	315	10	G 1/2"	32,5	13,0	14	27	19	GE-LR-10-G 1/2"	15,85
L	315	10	G 3/4"			16	32	19	GE-LR-10-G 3/4"	19,69
L	315	12	G 1/8"	29,0	11,0	8	19	22	GE-LR-12-G 1/8"	12,65
L	315	12	G 1/4"	30,0	12,0	12	19	22	GE-LR-12-G 1/4"	12,99
L	315	12	G 3/8"	27,0	12,5	12	22	22	GE-LR-12-G 3/8"	10,20
L	315	12	G 1/2"	31,0	13,0	14	27	22	GE-LR-12-G 1/2"	16,67
L	315	12	G 3/4"	31,0	14,0	16	32	22	GE-LR-12-G 3/4"	20,04
L	315	15	G 1/4"	32,0	13,0	12	24	27	GE-LR-15-G 1/4"	16,87
L	315	15	G 3/8"	31,0	13,5	12	24	27	GE-LR-15-G 3/8"	16,31
L	315	15	G 1/2"	29,0	14,0	14	27	27	GE-LR-15-G 1/2"	14,88
L	315	15	G 3/4"	32,5	15,0	16	32	27	GE-LR-15-G 3/4"	25,05
L	315	15	G 1"			18	41	27	GE-LR-15-G 1"	*
L	315	18	G 3/8"	31,0	12,5	12	27	32	GE-LR-18-G 3/8"	21,37
L	315	18	G 1/2"	31,0	14,5	14	27	32	GE-LR-18-G 1/2"	19,33
L	315	18	G 3/4"	34,0	14,5	16	32	32	GE-LR-18-G 3/4"	28,48
L	315	18	G 1"		16,5	18	41	32	GE-LR-18-G 1"	37,84
L	160	22	G 3/8"	49,0	16,0	12	32	36	GE-LR-22-G 3/8"	29,60
L	160	22	G 1/2"	37,0	16,5	14	32	36	GE-LR-22-G 1/2"	28,99
L	160	22	G 3/4"	33,0	16,5	16	32	36	GE-LR-22-G 3/4"	26,03
L	160	22	G 1"	38,0	17,5	18	41	36	GE-LR-22-G 1"	38,35
L	160	22	G 1 1/4"			20	50	36	GE-LR-22-G 1 1/4"	44,74
L	160	28	G 1/2"		17,5	14	41	41	GE-LR-28-G 1/2"	43,51
L	160	28	G 3/4"	38,0	17,5	16	41	41	GE-LR-28-G 3/4"	42,11
L	160	28	G 1"	34,0	17,5	18	41	41	GE-LR-28-G 1"	41,82
L	160	28	G 1 1/4"		18,5	20	50	41	GE-LR-28-G 1 1/4"	44,94
L	160	28	G 1 1/2"	43,0	20,5	22	55	41	GE-LR-28-G 1 1/2"	50,00
L	160	35	G 3/4"	42,0	18,5	16	46	50	GE-LR-35-G 3/4"	50,62
L	160	35	G 1"	42,0	17,5	18	46	50	GE-LR-35-G 1"	49,08
L	160	35	G 1 1/4"	39,0	17,5	20	50	50	GE-LR-35-G 1 1/4"	53,69
L	160	35	G 1 1/2"	44,0	19,5	22	55	50	GE-LR-35-G 1 1/2"	61,36
L	160	42	G 1"	47,0	19,0	18	55	60	GE-LR-42-G 1"	76,69
L	160	42	G 1 1/4"	47,0	19,0	20	55	60	GE-LR-42-G 1 1/4"	74,14
L	160	42	G 1 1/2"	47,0	19,0	22	55	60	GE-LR-42-G 1 1/2"	71,58
L	160	42	G 2"				70	60	GE-LR-42-G 2"	*

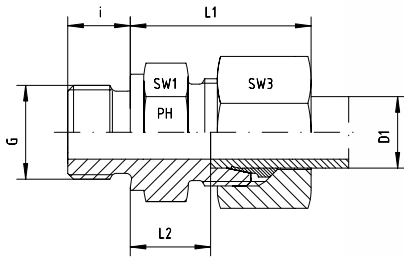

Gerade Einschraubverschraubungen

L-Reihe
Einschraubgewinde: Whitworth-Rohrgewinde - Zylindrisch
Abdichtung durch Dichtkante Form B

Male Stud Couplings

L-Series
Thread: BSP - Parallel
Sealing by Sealing Shoulder Form B

Reihe Series	Druck Pressure PN	Rohr A.D. Tube O.D. D1	Gewinde Thread G	Ca. Maße Approx. Dimensions					Bestellzeichen Order-Code SC	Brutto-Preis Gross-Price Euro (€)
				L1	L2	i	SW1	SW3		
L	315	6	G 1/8"	23,0	8,5	8	14	14	GE-LR-06-G 1/8"-SC	6,20
L	315	6	G 1/4"	27,0	9,0	12	19	14	GE-LR-06-G 1/4"-SC	10,44
L	315	6	G 3/8"	27,0	11,5	12	22	14	GE-LR-06-G 3/8"-SC	14,89
L	315	6	G 1/2"	29,0	12,0	14	27	14	GE-LR-06-G 1/2"-SC	16,17
L	315	8	G 1/8"	26,0	9,5	8	14	17	GE-LR-08-G 1/8"-SC	8,77
L	315	8	G 1/4"	25,0	10,0	12	19	17	GE-LR-08-G 1/4"-SC	7,90
L	315	8	G 3/8"	28,5	11,5	12	22	17	GE-LR-08-G 3/8"-SC	11,82
L	315	8	G 1/2"	28,5	13,0	14	27	17	GE-LR-08-G 1/2"-SC	15,01
L	315	10	G 1/8"	27,5	11,0	8	17	19	GE-LR-10-G 1/8"-SC	9,44
L	315	10	G 1/4"	26,0	11,0	12	19	19	GE-LR-10-G 1/4"-SC	8,83
L	315	10	G 3/8"	30,5	12,5	12	22	19	GE-LR-10-G 3/8"-SC	13,20
L	315	10	G 1/2"	32,5	13,0	14	27	19	GE-LR-10-G 1/2"-SC	16,29
L	315	10	G 3/4"			16	32	19	GE-LR-10-G 3/4"-SC	20,13
L	315	12	G 1/8"	29,0	11,0	8	19	22	GE-LR-12-G 1/8"-SC	13,21
L	315	12	G 1/4"	30,0	12,0	12	19	22	GE-LR-12-G 1/4"-SC	13,55
L	315	12	G 3/8"	27,0	12,5	12	22	22	GE-LR-12-G 3/8"-SC	10,76
L	315	12	G 1/2"	31,0	13,0	14	27	22	GE-LR-12-G 1/2"-SC	17,23
L	315	12	G 3/4"	31,0	14,0	16	32	22	GE-LR-12-G 3/4"-SC	20,60
L	315	15	G 1/4"	32,0	13,0	12	24	27	GE-LR-15-G 1/4"-SC	17,95
L	315	15	G 3/8"	31,0	13,5	12	24	27	GE-LR-15-G 3/8"-SC	17,39
L	315	15	G 1/2"	29,0	14,0	14	27	27	GE-LR-15-G 1/2"-SC	15,96
L	315	15	G 3/4"	32,5	15,0	16	32	27	GE-LR-15-G 3/4"-SC	26,13
L	315	15	G 1"			18	41	27	GE-LR-15-G 1"-SC	*
L	315	18	G 3/8"	31,0	12,5	12	27	32	GE-LR-18-G 3/8"-SC	23,01
L	315	18	G 1/2"	31,0	14,5	14	27	32	GE-LR-18-G 1/2"-SC	20,97
L	315	18	G 3/4"	34,0	14,5	16	32	32	GE-LR-18-G 3/4"-SC	30,12
L	315	18	G 1"		16,5	18	41	32	GE-LR-18-G 1"-SC	39,48
L	160	22	G 3/8"	49,0	16,0	12	32	36	GE-LR-22-G 3/8"-SC	31,36
L	160	22	G 1/2"	37,0	16,5	14	32	36	GE-LR-22-G 1/2"-SC	30,75
L	160	22	G 3/4"	33,0	16,5	16	32	36	GE-LR-22-G 3/4"-SC	27,79
L	160	22	G 1"	38,0	17,5	18	41	36	GE-LR-22-G 1"-SC	40,11
L	160	22	G 1 1/4"			20	50	36	GE-LR-22-G 1 1/4"-SC	46,50
L	160	28	G 1/2"		17,5	14	41	41	GE-LR-28-G 1/2"-SC	45,51
L	160	28	G 3/4"	38,0	17,5	16	41	41	GE-LR-28-G 3/4"-SC	44,11
L	160	28	G 1"	34,0	17,5	18	41	41	GE-LR-28-G 1"-SC	43,82
L	160	28	G 1 1/4"		18,5	20	50	41	GE-LR-28-G 1 1/4"-SC	46,94
L	160	28	G 1 1/2"	43,0	20,5	22	55	41	GE-LR-28-G 1 1/2"-SC	52,00
L	160	35	G 3/4"	42,0	18,5	16	46	50	GE-LR-35-G 3/4"-SC	54,34
L	160	35	G 1"	42,0	17,5	18	46	50	GE-LR-35-G 1"-SC	52,80
L	160	35	G 1 1/4"	39,0	17,5	20	50	50	GE-LR-35-G 1 1/4"-SC	57,41
L	160	35	G 1 1/2"	44,0	19,5	22	55	50	GE-LR-35-G 1 1/2"-SC	65,08
L	160	42	G 1"	47,0	19,0	18	55	60	GE-LR-42-G 1"-SC	81,01
L	160	42	G 1 1/4"	47,0	19,0	20	55	60	GE-LR-42-G 1 1/4"-SC	78,46
L	160	42	G 1 1/2"	47,0	19,0	22	55	60	GE-LR-42-G 1 1/2"-SC	75,90
L	160	42	G 2"			22	70	60	GE-LR-42-G 2"-SC	*



Gerade Einschraubverschraubungsstutzen

LL- und L-Reihe

Einschraubgewinde: Whitworth-Rohrgewinde - Zylindrisch
Abdichtung durch Dichtkante Form B

Male Stud Coupling Bodies

LL- and L-Series

Thread: BSP - Parallel

Sealing by Sealing Shoulder Form B

Reihe Series	Druck Pressure PN	Rohr A.D. Tube O.D. D1	Gewinde Thread G	Ca. Maße Approx. Dimensions				Bestellzeichen Order-Code OMD	Brutto-Preis Gross-Price Euro (€)
LL	100	4	G 1/8"					GE-LLR-04-G 1/8"-OMD	9,24
LL	100	6	G 1/8"					GE-LLR-06-G 1/8"-OMD	9,46
LL	100	8	G 1/8"					GE-LLR-08-G 1/8"-OMD	9,50

Reihe Series	Druck Pressure PN	Rohr A.D. Tube O.D. D1	Gewinde Thread G	Ca. Maße Approx. Dimensions				Bestellzeichen Order-Code OMD	Brutto-Preis Gross-Price Euro (€)
L	315	6	G 1/8"					GE-LR-06-G 1/8"-OMD	3,57
L	315	6	G 1/4"					GE-LR-06-G 1/4"-OMD	7,81
L	315	6	G 3/8"					GE-LR-06-G 3/8"-OMD	12,26
L	315	6	G 1/2"					GE-LR-06-G 1/2"-OMD	13,54
L	315	8	G 1/8"					GE-LR-08-G 1/8"-OMD	5,53
L	315	8	G 1/4"					GE-LR-08-G 1/4"-OMD	4,66
L	315	8	G 3/8"					GE-LR-08-G 3/8"-OMD	8,58
L	315	8	G 1/2"					GE-LR-08-G 1/2"-OMD	11,77
L	315	10	G 1/8"					GE-LR-10-G 1/8"-OMD	5,64
L	315	10	G 1/4"					GE-LR-10-G 1/4"-OMD	5,03
L	315	10	G 3/8"					GE-LR-10-G 3/8"-OMD	9,40
L	315	10	G 1/2"					GE-LR-10-G 1/2"-OMD	12,49
L	315	10	G 3/4"					GE-LR-10-G 3/4"-OMD	16,33
L	315	12	G 1/8"					GE-LR-12-G 1/8"-OMD	8,76
L	315	12	G 1/4"					GE-LR-12-G 1/4"-OMD	9,10
L	315	12	G 3/8"					GE-LR-12-G 3/8"-OMD	6,31
L	315	12	G 1/2"					GE-LR-12-G 1/2"-OMD	12,78
L	315	12	G 3/4"					GE-LR-12-G 3/4"-OMD	16,15
L	315	15	G 1/4"					GE-LR-15-G 1/4"-OMD	11,73
L	315	15	G 3/8"					GE-LR-15-G 3/8"-OMD	11,17
L	315	15	G 1/2"					GE-LR-15-G 1/2"-OMD	9,74
L	315	15	G 3/4"					GE-LR-15-G 3/4"-OMD	19,91
L	315	15	G 1"					GE-LR-15-G 1"-OMD	*
L	315	18	G 3/8"					GE-LR-18-G 3/8"-OMD	12,75
L	315	18	G 1/2"					GE-LR-18-G 1/2"-OMD	10,71
L	315	18	G 3/4"					GE-LR-18-G 3/4"-OMD	19,86
L	315	18	G 1"					GE-LR-18-G 1"-OMD	29,22
L	160	22	G 3/8"					GE-LR-22-G 3/8"-OMD	19,29
L	160	22	G 1/2"					GE-LR-22-G 1/2"-OMD	18,68
L	160	22	G 3/4"					GE-LR-22-G 3/4"-OMD	15,72
L	160	22	G 1"					GE-LR-22-G 1"-OMD	28,04
L	160	22	G 1 1/4"					GE-LR-22-G 1 1/4"-OMD	34,43
L	160	28	G 1/2"					GE-LR-28-G 1/2"-OMD	28,66
L	160	28	G 3/4"					GE-LR-28-G 3/4"-OMD	27,26
L	160	28	G 1"					GE-LR-28-G 1"-OMD	26,97
L	160	28	G 1 1/4"					GE-LR-28-G 1 1/4"-OMD	30,09
L	160	28	G 1 1/2"					GE-LR-28-G 1 1/2"-OMD	35,15
L	160	35	G 3/4"					GE-LR-35-G 3/4"-OMD	29,51
L	160	35	G 1"					GE-LR-35-G 1"-OMD	27,97
L	160	35	G 1 1/4"					GE-LR-35-G 1 1/4"-OMD	32,58
L	160	35	G 1 1/2"					GE-LR-35-G 1 1/2"-OMD	40,25
L	160	42	G 1"					GE-LR-42-G 1"-OMD	49,26
L	160	42	G 1 1/4"					GE-LR-42-G 1 1/4"-OMD	46,71
L	160	42	G 1 1/2"					GE-LR-42-G 1 1/2"-OMD	44,15
L	160	42	G 2"					GE-LR-42-G 2"-OMD	*

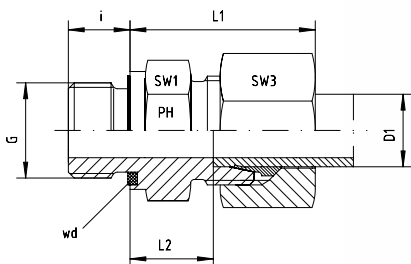

Gerade Einschraubverschraubungen

LL- and L-Reihe

Einschraubgewinde: Whitworth-Rohrgewinde - Zylindrisch
wd = Abdichtung durch Profildichtung - Viton

Male Stud Couplings

LL- and L-Series

Thread: BSP - Parallel

wd = Sealing by an Elastomer Profiled Ring - Viton

Reihe Series	Druck Pressure PN	Rohr A.D. Tube O.D. D1	Gewinde Thread G	Ca. Maße Approx. Dimensions					Bestellzeichen Order-Code Standard	Brutto-Preis Gross-Price Euro (€)
				L1	L2	i	SW1	SW3		
LL	100	4	G 1/8"	19,0	9,5	8	14	10	GE-LLR-04-G 1/8"-wd	12,50
LL	100	6	G 1/8"	20,0	9,5	8	14	12	GE-LLR-06-G 1/8"-wd	12,50
LL	100	8	G 1/8"		9,0	8	14	14	GE-LLR-08-G 1/8"-wd	13,80

Reihe Series	Druck Pressure PN	Rohr A.D. Tube O.D. D1	Gewinde Thread G	Ca. Maße Approx. Dimensions					Bestellzeichen Order-Code Standard	Brutto-Preis Gross-Price Euro (€)
				L1	L2	i	SW1	SW3		
L	500	6	G 1/8"	23,0	8,5	8	14	14	GE-LR-06-G 1/8"-wd	7,93
L	500	6	G 1/4"	27,0	9,0	12	17	14	GE-LR-06-G 1/4"-wd	12,17
L	400	6	G 3/8"	27,0	11,5	12	22	14	GE-LR-06-G 3/8"-wd	15,32
L	400	6	G 1/2"	29,0	12,0	14	27	14	GE-LR-06-G 1/2"-wd	17,46
L	500	8	G 1/8"	26,0	9,5	8	14	17	GE-LR-08-G 1/8"-wd	9,56
L	500	8	G 1/4"	25,0	10,0	12	19	17	GE-LR-08-G 1/4"-wd	9,51
L	400	8	G 3/8"	28,5	11,5	12	22	17	GE-LR-08-G 3/8"-wd	13,42
L	400	8	G 1/2"	28,5	13,0	14	27	17	GE-LR-08-G 1/2"-wd	16,44
L	500	10	G 1/8"	27,5	11,0	8	17	19	GE-LR-10-G 1/8"-wd	11,04
L	500	10	G 1/4"	26,0	11,0	12	19	19	GE-LR-10-G 1/4"-wd	10,43
L	400	10	G 3/8"	30,5	12,5	12	22	19	GE-LR-10-G 3/8"-wd	14,80
L	400	10	G 1/2"	32,5	13,0	14	27	19	GE-LR-10-G 1/2"-wd	19,58
L	250	10	G 3/4"		14,0	16	32	19	GE-LR-10-G 3/4"-wd	22,75
L	400	12	G 1/8"	29,0	11,0	8	19	22	GE-LR-12-G 1/8"-wd	16,36
L	400	12	G 1/4"	30,0	12,0	12	19	22	GE-LR-12-G 1/4"-wd	15,03
L	400	12	G 3/8"	27,0	12,5	12	22	22	GE-LR-12-G 3/8"-wd	12,25
L	400	12	G 1/2"	31,0	13,0	14	27	22	GE-LR-12-G 1/2"-wd	18,71
L	250	12	G 3/4"	31,0	14,0	16	32	22	GE-LR-12-G 3/4"-wd	23,26
L	400	15	G 1/4"	32,0	13,0	12	24	27	GE-LR-15-G 1/4"-wd	18,92
L	400	15	G 3/8"	31,0	13,5	12	24	27	GE-LR-15-G 3/8"-wd	18,38
L	400	15	G 1/2"	29,0	14,0	14	27	27	GE-LR-15-G 1/2"-wd	16,92
L	250	15	G 3/4"	32,5	15,0	16	32	27	GE-LR-15-G 3/4"-wd	28,12
L	250	15	G 1"		16,0	18	41	27	GE-LR-15-G 1"-wd	91,35
L	400	18	G 1/4"		13,5	12	27	32	GE-LR-18-G 1/4"-wd	22,75
L	400	18	G 3/8"	33,0	12,5	12	27	32	GE-LR-18-G 3/8"-wd	22,75
L	400	18	G 1/2"	31,0	14,5	14	27	32	GE-LR-18-G 1/2"-wd	21,37
L	315	18	G 3/4"	34,0	14,5	16	32	32	GE-LR-18-G 3/4"-wd	30,17
L	250	18	G 1"		16,5	18	41	32	GE-LR-18-G 1"-wd	40,90
L	250	22	G 3/8"	49,0	16,0	12	32	36	GE-LR-22-G 3/8"-wd	31,65
L	250	22	G 1/2"	37,0	16,5	14	32	36	GE-LR-22-G 1/2"-wd	31,04
L	250	22	G 3/4"	33,0	16,5	16	32	36	GE-LR-22-G 3/4"-wd	28,58
L	250	22	G 1"	38,0	17,5	18	41	36	GE-LR-22-G 1"-wd	41,42
L	250	22	G 1 1/4"		18,5	20	50	36	GE-LR-22-G 1 1/4"-wd	48,83
L	250	28	G 1/2"		17,5	14	41	41	GE-LR-28-G 1/2"-wd	47,55
L	250	28	G 3/4"	38,0	17,5	16	41	41	GE-LR-28-G 3/4"-wd	44,02
L	250	28	G 1"	34,0	17,5	18	41	41	GE-LR-28-G 1"-wd	44,89
L	250	28	G 1 1/4"		18,5	20	50	41	GE-LR-28-G 1 1/4"-wd	49,03
L	250	28	G 1 1/2"	43,0	20,5	22	55	41	GE-LR-28-G 1 1/2"-wd	50,90
L	250	35	G 1/2"	42,0	17,5	14	46	50	GE-LR-35-G 1/2"-wd	85,11
L	250	35	G 3/4"	42,0	18,5	16	46	50	GE-LR-35-G 3/4"-wd	53,69
L	250	35	G 1"	42,0	17,5	18	46	50	GE-LR-35-G 1"-wd	51,90
L	250	35	G 1 1/4"	39,0	17,5	20	50	50	GE-LR-35-G 1 1/4"-wd	55,22
L	250	35	G 1 1/2"	44,0	19,5	22	55	50	GE-LR-35-G 1 1/2"-wd	63,91
L	250	42	G 1"	47,0	19,0	18	55	60	GE-LR-42-G 1"-wd	76,69
L	250	42	G 1 1/4"	47,0	19,0	20	55	60	GE-LR-42-G 1 1/4"-wd	76,69
L	250	42	G 1 1/2"	47,0	19,0	22	55	60	GE-LR-42-G 1 1/2"-wd	76,69
L	250	42	G 2"		21,0	23	70	60	GE-LR-42-G 2"-wd	294,00

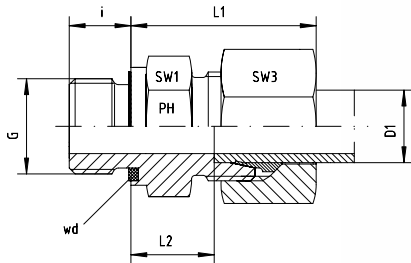

Gerade Einschraubverschraubungen

L-Reihe

Einschraubgewinde: Whitworth-Rohrgewinde - Zylindrisch
wd = Abdichtung durch Profildichtung - Viton

Male Stud Couplings

L-Series

Thread: BSP - Parallel

wd = Sealing by an Elastomer Profiled Ring - Viton

Reihe Series	Druck Pressure PN	Rohr A.D. Tube O.D. D1	Gewinde Thread G	Ca. Maße Approx. Dimensions					Bestellzeichen Order-Code SC	Brutto-Preis Gross-Price Euro (€)
				L1	L2	i	SW1	SW3		
L	500	6	G 1/8"	23,0	8,5	8	14	14	GE-LR-06-G 1/8"-wd-SC	8,25
L	500	6	G 1/4"	27,0	9,0	12	17	14	GE-LR-06-G 1/4"-wd-SC	12,49
L	400	6	G 3/8"	27,0	11,5	12	22	14	GE-LR-06-G 3/8"-wd-SC	15,64
L	400	6	G 1/2"	29,0	12,0	14	27	14	GE-LR-06-G 1/2"-wd-SC	17,78
L	500	8	G 1/8"	26,0	9,5	8	14	17	GE-LR-08-G 1/8"-wd-SC	10,00
L	500	8	G 1/4"	25,0	10,0	12	19	17	GE-LR-08-G 1/4"-wd-SC	9,95
L	400	8	G 3/8"	28,5	11,5	12	22	17	GE-LR-08-G 3/8"-wd-SC	13,86
L	400	8	G 1/2"	28,5	13,0	14	27	17	GE-LR-08-G 1/2"-wd-SC	16,88
L	500	10	G 1/8"	27,5	11,0	8	17	19	GE-LR-10-G 1/8"-wd-SC	11,48
L	500	10	G 1/4"	26,0	11,0	12	19	19	GE-LR-10-G 1/4"-wd-SC	10,87
L	400	10	G 3/8"	30,5	12,5	12	22	19	GE-LR-10-G 3/8"-wd-SC	15,24
L	400	10	G 1/2"	32,5	13,0	14	27	19	GE-LR-10-G 1/2"-wd-SC	20,02
L	250	10	G 3/4"			16	32	19	GE-LR-10-G 3/4"-wd-SC	23,19
L	400	12	G 1/8"	29,0	11,0	8	19	22	GE-LR-12-G 1/8"-wd-SC	16,92
L	400	12	G 1/4"	30,0	12,0	12	19	22	GE-LR-12-G 1/4"-wd-SC	15,59
L	400	12	G 3/8"	27,0	12,5	12	22	22	GE-LR-12-G 3/8"-wd-SC	12,81
L	400	12	G 1/2"	31,0	13,0	14	27	22	GE-LR-12-G 1/2"-wd-SC	19,27
L	250	12	G 3/4"	31,0	14,0	16	32	22	GE-LR-12-G 3/4"-wd-SC	23,82
L	400	15	G 1/4"	32,0	13,0	12	24	27	GE-LR-15-G 1/4"-wd-SC	20,00
L	400	15	G 3/8"	31,0	13,5	12	24	27	GE-LR-15-G 3/8"-wd-SC	19,46
L	400	15	G 1/2"	29,0	14,0	14	27	27	GE-LR-15-G 1/2"-wd-SC	18,00
L	250	15	G 3/4"	32,5	15,0	16	32	27	GE-LR-15-G 3/4"-wd-SC	29,20
L	250	15	G 1"			18	41	27	GE-LR-15-G 1"-wd-SC	*
L	400	18	G 3/8"	33,0	12,5	12	27	32	GE-LR-18-G 3/8"-wd-SC	24,39
L	400	18	G 1/2"	31,0	14,5	14	27	32	GE-LR-18-G 1/2"-wd-SC	23,01
L	315	18	G 3/4"	34,0	14,5	16	32	32	GE-LR-18-G 3/4"-wd-SC	31,81
L	250	18	G 1"		16,5	18	41	32	GE-LR-18-G 1"-wd-SC	42,54
L	250	22	G 3/8"	49,0	16,0	12	32	36	GE-LR-22-G 3/8"-wd-SC	33,41
L	250	22	G 1/2"	37,0	16,5	14	32	36	GE-LR-22-G 1/2"-wd-SC	32,80
L	250	22	G 3/4"	33,0	16,5	16	32	36	GE-LR-22-G 3/4"-wd-SC	30,34
L	250	22	G 1"	38,0	17,5	18	41	36	GE-LR-22-G 1"-wd-SC	43,18
L	250	22	G 1 1/4"			20	50	36	GE-LR-22-G 1 1/4"-wd-SC	50,59
L	250	28	G 1/2"		17,5	14	41	41	GE-LR-28-G 1/2"-wd-SC	49,55
L	250	28	G 3/4"	38,0	17,5	16	41	41	GE-LR-28-G 3/4"-wd-SC	46,02
L	250	28	G 1"	34,0	17,5	18	41	41	GE-LR-28-G 1"-wd-SC	46,89
L	250	28	G 1 1/4"		18,5	20	50	41	GE-LR-28-G 1 1/4"-wd-SC	51,03
L	250	28	G 1 1/2"	43,0	20,5	22	55	41	GE-LR-28-G 1 1/2"-wd-SC	52,90
L	250	35	G 1/2"	42,0	17,5	14	46	50	GE-LR-35-G 1/2"-wd-SC	88,83
L	250	35	G 3/4"		18,5	16	46	50	GE-LR-35-G 3/4"-wd-SC	57,41
L	250	35	G 1"	42,0	17,5	18	46	50	GE-LR-35-G 1"-wd-SC	55,62
L	250	35	G 1 1/4"	39,0	17,5	20	50	50	GE-LR-35-G 1 1/4"-wd-SC	58,94
L	250	35	G 1 1/2"	44,0	19,5	22	55	50	GE-LR-35-G 1 1/2"-wd-SC	67,63
L	250	42	G 1"	47,0	19,0	18	55	60	GE-LR-42-G 1"-wd-SC	81,01
L	250	42	G 1 1/4"	47,0	19,0	20	55	60	GE-LR-42-G 1 1/4"-wd-SC	81,01
L	250	42	G 1 1/2"	47,0	19,0	22	55	60	GE-LR-42-G 1 1/2"-wd-SC	81,01
L	250	42	G 2"		21,0	23	70	60	GE-LR-42-G 2"-wd-SC	299,69



Gerade Einschraubverschraubungsstutzen

LL- und L-Reihe

Einschraubgewinde: Whitworth-Rohrgewinde - Zylindrisch

wd = Abdichtung durch Profildichtung - Viton

Male Stud Coupling Bodies

LL- and L-Series

Thread: BSP - Parallel

wd = Sealing by an Elastomer Profiled Ring - Viton

Reihe Series	Druck Pressure PN	Rohr A.D. Tube O.D. D1	Gewinde Thread G	Ca. Maße Approx. Dimensions				Bestellzeichen Order-Code OMD	Brutto-Preis Gross-Price Euro (€)
LL	100	4	G 1/8"					GE-LLR-04-G 1/8"-wd-OMD	9,84
LL	100	6	G 1/8"					GE-LLR-06-G 1/8"-wd-OMD	9,46
LL	100	8	G 1/8"					GE-LLR-08-G 1/8"-wd-OMD	10,30

Reihe Series	Druck Pressure PN	Rohr A.D. Tube O.D. D1	Gewinde Thread G	Ca. Maße Approx. Dimensions				Bestellzeichen Order-Code OMD	Brutto-Preis Gross-Price Euro (€)
L	500	6	G 1/8"					GE-LR-06-G 1/8"-wd-OMD	5,62
L	500	6	G 1/4"					GE-LR-06-G 1/4"-wd-OMD	9,86
L	400	6	G 3/8"					GE-LR-06-G 3/8"-wd-OMD	13,01
L	400	6	G 1/2"					GE-LR-06-G 1/2"-wd-OMD	15,15
L	500	8	G 1/8"					GE-LR-08-G 1/8"-wd-OMD	6,76
L	500	8	G 1/4"					GE-LR-08-G 1/4"-wd-OMD	6,71
L	400	8	G 3/8"					GE-LR-08-G 3/8"-wd-OMD	10,62
L	400	8	G 1/2"					GE-LR-08-G 1/2"-wd-OMD	13,64
L	500	10	G 1/8"					GE-LR-10-G 1/8"-wd-OMD	7,68
L	500	10	G 1/4"					GE-LR-10-G 1/4"-wd-OMD	7,07
L	400	10	G 3/8"					GE-LR-10-G 3/8"-wd-OMD	11,44
L	400	10	G 1/2"					GE-LR-10-G 1/2"-wd-OMD	16,22
L	250	10	G 3/4"					GE-LR-10-G 3/4"-wd-OMD	19,39
L	400	12	G 1/8"					GE-LR-12-G 1/8"-wd-OMD	12,47
L	400	12	G 1/4"					GE-LR-12-G 1/4"-wd-OMD	11,14
L	400	12	G 3/8"					GE-LR-12-G 3/8"-wd-OMD	8,36
L	400	12	G 1/2"					GE-LR-12-G 1/2"-wd-OMD	14,82
L	250	12	G 3/4"					GE-LR-12-G 3/4"-wd-OMD	19,37
L	400	15	G 1/4"					GE-LR-15-G 1/4"-wd-OMD	13,78
L	400	15	G 3/8"					GE-LR-15-G 3/8"-wd-OMD	13,24
L	400	15	G 1/2"					GE-LR-15-G 1/2"-wd-OMD	11,78
L	250	15	G 3/4"					GE-LR-15-G 3/4"-wd-OMD	22,98
L	250	15	G 1"					GE-LR-15-G 1"-wd-OMD	86,21
L	400	18	G 3/8"					GE-LR-18-G 3/8"-wd-OMD	14,13
L	400	18	G 1/2"					GE-LR-18-G 1/2"-wd-OMD	12,75
L	315	18	G 3/4"					GE-LR-18-G 3/4"-wd-OMD	21,55
L	250	18	G 1"					GE-LR-18-G 1"-wd-OMD	32,28
L	250	22	G 3/8"					GE-LR-22-G 3/8"-wd-OMD	21,34
L	250	22	G 1/2"					GE-LR-22-G 1/2"-wd-OMD	20,73
L	250	22	G 3/4"					GE-LR-22-G 3/4"-wd-OMD	18,27
L	250	22	G 1"					GE-LR-22-G 1"-wd-OMD	31,11
L	250	22	G 1 1/4"					GE-LR-22-G 1 1/4"-wd-OMD	38,52
L	250	28	G 1/2"					GE-LR-28-G 1/2"-wd-OMD	32,70
L	250	28	G 3/4"					GE-LR-28-G 3/4"-wd-OMD	29,17
L	250	28	G 1"					GE-LR-28-G 1"-wd-OMD	30,04
L	250	28	G 1 1/4"					GE-LR-28-G 1 1/4"-wd-OMD	34,18
L	250	28	G 1 1/2"					GE-LR-28-G 1 1/2"-wd-OMD	36,05
L	250	35	G 1/2"					GE-LR-35-G 1/2"-wd-OMD	64,00
L	250	35	G 3/4"					GE-LR-35-G 3/4"-wd-OMD	32,58
L	250	35	G 1"					GE-LR-35-G 1"-wd-OMD	30,79
L	250	35	G 1 1/4"					GE-LR-35-G 1 1/4"-wd-OMD	34,11
L	250	35	G 1 1/2"					GE-LR-35-G 1 1/2"-wd-OMD	42,80
L	250	42	G 1"					GE-LR-42-G 1"-wd-OMD	49,26
L	250	42	G 1 1/4"					GE-LR-42-G 1 1/4"-wd-OMD	49,26
L	250	42	G 1 1/2"					GE-LR-42-G 1 1/2"-wd-OMD	49,26
L	250	42	G 2"					GE-LR-42-G 2"-wd-OMD	266,57

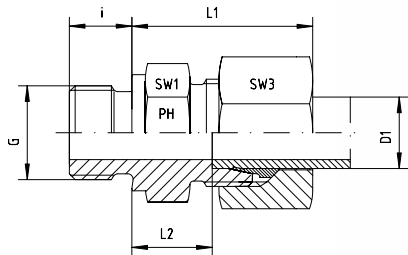

Gerade Einschraubverschraubungen

S-Reihe

Einschraubgewinde: Whitworth-Rohrgewinde - Zylindrisch
Abdichtung durch Dichtkante Form B

Male Stud Couplings

S-Series

Thread: BSP - Parallel

Sealing by Sealing Shoulder Form B

Reihe Series	Druck Pressure PN	Rohr A.D. Tube O.D. D1	Gewinde Thread G	Ca. Maße Approx. Dimensions					Bestellzeichen Order-Code Standard	Brutto-Preis Gross-Price Euro (€)
				L1	L2	i	SW1	SW3		
S	630	6	G 1/8"	28,0	13,0	8	14	17	GE-SR-06-G 1/8"	7,26
S	630	6	G 1/4"	28,0	13,0	12	19	17	GE-SR-06-G 1/4"	7,26
S	630	6	G 3/8"	30,0	15,5	12	22	19	GE-SR-06-G 3/8"	9,51
S	630	6	G 1/2"	34,0	17,0	14	27	19	GE-SR-06-G 1/2"	15,34
S	630	8	G 1/8"		14,0	8	17	19	GE-SR-08-G 1/8"	10,20
S	630	8	G 1/4"	30,0	15,0	12	19	19	GE-SR-08-G 1/4"	8,49
S	630	8	G 3/8"		15,5	12	22	19	GE-SR-08-G 3/8"	9,79
S	630	8	G 1/2"		15,0	14	27	19	GE-SR-08-G 1/2"	15,34
S	630	10	G 1/8"		13,5	8	19	22	GE-SR-10-G 1/8"	12,73
S	630	10	G 1/4"		14,5	12	19	22	GE-SR-10-G 1/4"	11,25
S	630	10	G 3/8"	31,0	15,0	12	22	22	GE-SR-10-G 3/8"	10,94
S	630	10	G 1/2"		13,5	14	27	22	GE-SR-10-G 1/2"	16,11
S	630	10	G 3/4"			16	32	22	GE-SR-10-G 3/4"	26,33
S	630	12	G 1/4"		16,5	12	22	24	GE-SR-12-G 1/4"	13,14
S	630	12	G 3/8"	33,0	17,0	12	22	24	GE-SR-12-G 3/8"	11,86
S	630	12	G 1/2"	34,0	17,5	14	27	24	GE-SR-12-G 1/2"	17,59
S	630	12	G 3/4"	36,0	17,5	16	32	24	GE-SR-12-G 3/4"	26,33
S	630	14	G 1/4"	37,0	17,0	12	24	27	GE-SR-14-G 1/4"	27,20
S	630	14	G 3/8"	37,0	17,0	12	24	27	GE-SR-14-G 3/8"	15,13
S	630	14	G 1/2"	37,0	19,0	14	27	27	GE-SR-14-G 1/2"	16,67
S	400	14	G 3/4"		19,0	16	32	27	GE-SR-14-G 3/4"	27,00
S	400	16	G 1/4"	38,0	17,5	12	27	30	GE-SR-16-G 1/4"	22,24
S	400	16	G 3/8"		18,0	12	27	30	GE-SR-16-G 3/8"	21,07
S	400	16	G 1/2"	37,0	18,5	14	27	30	GE-SR-16-G 1/2"	20,96
S	400	16	G 3/4"	39,0	20,5	16	32	30	GE-SR-16-G 3/4"	27,02
S	400	16	G 1"	43,5	22,5	18	41	30	GE-SR-16-G 1"	40,14
S	400	20	G 3/8"		18,0	12	32	36	GE-SR-20-G 3/8"	33,69
S	400	20	G 1/2"		20,5	14	32	36	GE-SR-20-G 1/2"	31,39
S	400	20	G 3/4"	42,0	20,5	16	32	36	GE-SR-20-G 3/4"	28,53
S	400	20	G 1"		22,5	18	41	36	GE-SR-20-G 1"	40,65
S	400	20	G 1 1/4"		22,5	20	50	36	GE-SR-20-G 1 1/4"	45,50
S	400	25	G 1/2"		23,0	14	41	46	GE-SR-25-G 1/2"	53,18
S	400	25	G 3/4"		23,0	16	41	46	GE-SR-25-G 3/4"	50,11
S	400	25	G 1"	47,0	23,0	18	41	46	GE-SR-25-G 1"	49,24
S	250	25	G 1 1/4"		23,0	20	50	46	GE-SR-25-G 1 1/4"	58,29
S	250	30	G 3/4"		25,5	16	46	50	GE-SR-30-G 3/4"	65,19
S	250	30	G 1"	50,0	23,5	18	46	50	GE-SR-30-G 1"	58,80
S	250	30	G 1 1/4"	50,0	23,5	20	50	50	GE-SR-30-G 1 1/4"	58,80
S	250	30	G 1 1/2"	50,0	23,5	22	55	50	GE-SR-30-G 1 1/2"	74,14
S	250	38	G 1"	42,0	26,0	18	46	50	GE-SR-38-G 1"	82,27
S	250	38	G 1 1/4"		23,0	20	55	60	GE-SR-38-G 1 1/4"	76,69
S	250	38	G 1 1/2"	57,0	26,0	22	55	60	GE-SR-38-G 1 1/2"	74,14
S	250	38	G 2"				70	60	GE-SR-38-G 2"	*

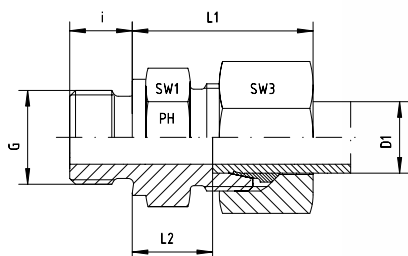

Gerade Einschraubverschraubungen

S-Reihe

Einschraubgewinde: Whitworth-Rohrgewinde - Zylindrisch
Abdichtung durch Dichtkante Form B

Male Stud Couplings

S-Series

Thread: BSP - Parallel

Sealing by Sealing Shoulder Form B

Reihe Series	Druck Pressure PN	Rohr A.D. Tube O.D. D1	Gewinde Thread G	Ca. Maße Approx. Dimensions					Bestellzeichen Order-Code SC	Brutto-Preis Gross-Price Euro (€)
				L1	L2	i	SW1	SW3		
S	630	6	G 1/8"	28,0	13,0	8	14	17	GE-SR-06-G 1/8"-SC	7,70
S	630	6	G 1/4"	28,0	13,0	12	19	17	GE-SR-06-G 1/4"-SC	7,70
S	630	6	G 3/8"	30,0	15,5	12	22	19	GE-SR-06-G 3/8"-SC	9,95
S	630	6	G 1/2"	34,0	17,0	14	27	19	GE-SR-06-G 1/2"-SC	15,78
S	630	8	G 1/8"		14,0	8	17	19	GE-SR-08-G 1/8"-SC	10,64
S	630	8	G 1/4"	30,0	15,0	12	19	19	GE-SR-08-G 1/4"-SC	8,93
S	630	8	G 3/8"		15,5	12	22	19	GE-SR-08-G 3/8"-SC	10,23
S	630	8	G 1/2"		15,0	14	27	19	GE-SR-08-G 1/2"-SC	15,78
S	630	10	G 1/8"		13,5	8	19	22	GE-SR-10-G 1/8"-SC	13,29
S	630	10	G 1/4"		14,5	12	19	22	GE-SR-10-G 1/4"-SC	11,81
S	630	10	G 3/8"	31,0	15,0	12	22	22	GE-SR-10-G 3/8"-SC	11,50
S	630	10	G 1/2"		13,5	14	27	22	GE-SR-10-G 1/2"-SC	16,67
S	630	10	G 3/4"			16	32	22	GE-SR-10-G 3/4"-SC	26,89
S	630	12	G 1/4"		16,5	12	22	24	GE-SR-12-G 1/4"-SC	13,98
S	630	12	G 3/8"	33,0	17,0	12	22	24	GE-SR-12-G 3/8"-SC	12,70
S	630	12	G 1/2"	34,0	17,5	14	27	24	GE-SR-12-G 1/2"-SC	18,43
S	630	12	G 3/4"	36,0	17,5	16	32	24	GE-SR-12-G 3/4"-SC	27,17
S	630	14	G 1/4"	37,0	17,0	12	24	27	GE-SR-14-G 1/4"-SC	28,76
S	630	14	G 3/8"	37,0	17,0	12	24	27	GE-SR-14-G 3/8"-SC	16,69
S	630	14	G 1/2"	37,0	19,0	14	27	27	GE-SR-14-G 1/2"-SC	18,23
S	400	14	G 3/4"		19,0	16	32	27	GE-SR-14-G 3/4"-SC	28,56
S	400	16	G 1/4"	38,0	17,5	12	27	30	GE-SR-16-G 1/4"-SC	23,80
S	400	16	G 3/8"		18,0	12	27	30	GE-SR-16-G 3/8"-SC	22,63
S	400	16	G 1/2"	37,0	18,5	14	27	30	GE-SR-16-G 1/2"-SC	22,52
S	400	16	G 3/4"	39,0	20,5	16	32	30	GE-SR-16-G 3/4"-SC	28,58
S	400	16	G 1"	43,5	22,5	18	41	30	GE-SR-16-G 1"-SC	41,70
S	400	20	G 3/8"		18,0	12	32	36	GE-SR-20-G 3/8"-SC	35,57
S	400	20	G 1/2"		20,5	14	32	36	GE-SR-20-G 1/2"-SC	33,27
S	400	20	G 3/4"	42,0	20,5	16	32	36	GE-SR-20-G 3/4"-SC	30,41
S	400	20	G 1"		22,5	18	41	36	GE-SR-20-G 1"-SC	42,53
S	400	20	G 1 1/4"		22,5	20	50	36	GE-SR-20-G 1 1/4"-SC	47,38
S	400	25	G 1/2"		23,0	14	41	46	GE-SR-25-G 1/2"-SC	56,18
S	400	25	G 3/4"		23,0	16	41	46	GE-SR-25-G 3/4"-SC	53,11
S	400	25	G 1"	47,0	23,0	18	41	46	GE-SR-25-G 1"-SC	52,24
S	250	25	G 1 1/4"		23,0	20	50	46	GE-SR-25-G 1 1/4"-SC	61,29
S	250	30	G 3/4"		25,5	16	46	50	GE-SR-30-G 3/4"-SC	69,35
S	250	30	G 1"	50,0	23,5	18	46	50	GE-SR-30-G 1"-SC	62,96
S	250	30	G 1 1/4"	50,0	23,5	20	50	50	GE-SR-30-G 1 1/4"-SC	62,96
S	250	30	G 1 1/2"	50,0	23,5	22	55	50	GE-SR-30-G 1 1/2"-SC	78,30
S	250	38	G 1"	42,0	26,0	18	46	50	GE-SR-38-G 1"-SC	87,91
S	250	38	G 1 1/4"		23,0	20	55	60	GE-SR-38-G 1 1/4"-SC	82,33
S	250	38	G 1 1/2"	57,0	26,0	22	55	60	GE-SR-38-G 1 1/2"-SC	79,78
S	250	38	G 2"				70	60	GE-SR-38-G 2"-SC	*



Gerade Einschraubverschraubungsstutzen

S-Reihe

Einschraubgewinde: Whitworth-Rohrgewinde - Zylindrisch
Abdichtung durch Dichtkante Form B

Male Stud Coupling Bodies

S-Series

Thread: BSP - Parallel

Sealing by Sealing Shoulder Form B

Reihe Series	Druck Pressure PN	Rohr A.D. Tube O.D. D1	Gewinde Thread G	Ca. Maße Approx. Dimensions				Bestellzeichen Order-Code OMD	Brutto-Preis Gross-Price Euro (€)
S	630	6	G 1/8"				GE-SR-06-G 1/8"-OMD	4,47	
S	630	6	G 1/4"				GE-SR-06-G 1/4"-OMD	4,47	
S	630	6	G 3/8"				GE-SR-06-G 3/8"-OMD	6,72	
S	630	6	G 1/2"				GE-SR-06-G 1/2"-OMD	12,55	
S	630	8	G 1/8"				GE-SR-08-G 1/8"-OMD	7,00	
S	630	8	G 1/4"				GE-SR-08-G 1/4"-OMD	5,29	
S	630	8	G 3/8"				GE-SR-08-G 3/8"-OMD	6,59	
S	630	8	G 1/2"				GE-SR-08-G 1/2"-OMD	12,14	
S	630	10	G 1/8"				GE-SR-10-G 1/8"-OMD	8,79	
S	630	10	G 1/4"				GE-SR-10-G 1/4"-OMD	7,31	
S	630	10	G 3/8"				GE-SR-10-G 3/8"-OMD	7,00	
S	630	10	G 1/2"				GE-SR-10-G 1/2"-OMD	12,17	
S	630	10	G 3/4"				GE-SR-10-G 3/4"-OMD	22,39	
S	630	12	G 1/4"				GE-SR-12-G 1/4"-OMD	8,69	
S	630	12	G 3/8"				GE-SR-12-G 3/8"-OMD	7,41	
S	630	12	G 1/2"				GE-SR-12-G 1/2"-OMD	13,14	
S	630	12	G 3/4"				GE-SR-12-G 3/4"-OMD	21,88	
S	630	14	G 1/4"				GE-SR-14-G 1/4"-OMD	21,70	
S	630	14	G 3/8"				GE-SR-14-G 3/8"-OMD	9,63	
S	630	14	G 1/2"				GE-SR-14-G 1/2"-OMD	11,17	
S	400	14	G 3/4"				GE-SR-14-G 3/4"-OMD	21,50	
S	400	16	G 1/4"				GE-SR-16-G 1/4"-OMD	14,03	
S	400	16	G 3/8"				GE-SR-16-G 3/8"-OMD	12,86	
S	400	16	G 1/2"				GE-SR-16-G 1/2"-OMD	12,75	
S	400	16	G 3/4"				GE-SR-16-G 3/4"-OMD	18,81	
S	400	16	G 1"				GE-SR-16-G 1"-OMD	31,93	
S	400	20	G 3/8"				GE-SR-20-G 3/8"-OMD	23,11	
S	400	20	G 1/2"				GE-SR-20-G 1/2"-OMD	20,81	
S	400	20	G 3/4"				GE-SR-20-G 3/4"-OMD	17,95	
S	400	20	G 1"				GE-SR-20-G 1"-OMD	30,07	
S	400	20	G 1 1/4"				GE-SR-20-G 1 1/4"-OMD	34,92	
S	400	25	G 1/2"				GE-SR-25-G 1/2"-OMD	34,56	
S	400	25	G 3/4"				GE-SR-25-G 3/4"-OMD	31,49	
S	400	25	G 1"				GE-SR-25-G 1"-OMD	30,62	
S	250	25	G 1 1/4"				GE-SR-25-G 1 1/4"-OMD	39,67	
S	250	30	G 3/4"				GE-SR-30-G 3/4"-OMD	41,75	
S	250	30	G 1"				GE-SR-30-G 1"-OMD	35,36	
S	250	30	G 1 1/4"				GE-SR-30-G 1 1/4"-OMD	35,36	
S	250	30	G 1 1/2"				GE-SR-30-G 1 1/2"-OMD	50,70	
S	250	38	G 1"				GE-SR-38-G 1"-OMD	50,46	
S	250	38	G 1 1/4"				GE-SR-38-G 1 1/4"-OMD	44,88	
S	250	38	G 1 1/2"				GE-SR-38-G 1 1/2"-OMD	42,33	
S	250	38	G 2"				GE-SR-38-G 2"-OMD	*	

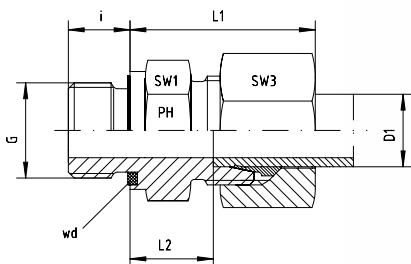

Gerade Einschraubverschraubungen

S-Reihe

Einschraubgewinde: Whitworth-Rohrgewinde - Zylindrisch
wd = Abdichtung durch Profildichtung - Viton

Male Stud Couplings

S-Series

Thread: BSP - Parallel

wd = Sealing by an Elastomer Profiled Ring - Viton

Reihe Series	Druck Pressure PN	Rohr A.D. Tube O.D. D1	Gewinde Thread G	Ca. Maße Approx. Dimensions					Bestellzeichen Order-Code Standard	Brutto-Preis Gross-Price Euro (€)
				L1	L2	i	SW1	SW3		
S	800	6	G 1/8"	28,0	13,0	8		17	GE-SR-06-G 1/8"-wd	10,84
S	800	6	G 1/4"	28,0	13,0	12	19	17	GE-SR-06-G 1/4"-wd	10,84
S	800	6	G 3/8"	30,0	15,5	12	22	19	GE-SR-06-G 3/8"-wd	13,09
S	630	6	G 1/2"	34,0	17,0	14	27	19	GE-SR-06-G 1/2"-wd	17,23
S	800	8	G 1/8"		14,0	8	17	19	GE-SR-08-G 1/8"-wd	12,48
S	800	8	G 1/4"	30,0	15,0	12	19	19	GE-SR-08-G 1/4"-wd	10,53
S	800	8	G 3/8"		15,5	12	22	19	GE-SR-08-G 3/8"-wd	11,84
S	630	8	G 1/2"		15,0	14	27	19	GE-SR-08-G 1/2"-wd	17,38
S	800	10	G 1/8"		13,5	8	19	22	GE-SR-10-G 1/8"-wd	15,08
S	800	10	G 1/4"		14,5	12	19	22	GE-SR-10-G 1/4"-wd	13,29
S	800	10	G 3/8"	31,0	15,0	12	22	22	GE-SR-10-G 3/8"-wd	12,99
S	630	10	G 1/2"		13,5	14	27	22	GE-SR-10-G 1/2"-wd	17,84
S	420	10	G 3/4"	36,0	17,5	16	32	22	GE-SR-10-G 3/4"-wd	28,89
S	630	12	G 1/4"		16,5	12	22	24	GE-SR-12-G 1/4"-wd	14,90
S	630	12	G 3/8"	33,0	17,0	12	22	24	GE-SR-12-G 3/8"-wd	13,91
S	630	12	G 1/2"	34,0	17,5	14	27	24	GE-SR-12-G 1/2"-wd	19,63
S	420	12	G 3/4"	36,0	17,5	16	32	24	GE-SR-12-G 3/4"-wd	29,40
S	630	14	G 1/4"	37,0	17,0	12	24	27	GE-SR-14-G 1/4"-wd	29,35
S	630	14	G 3/8"	37,0	17,0	12	24	27	GE-SR-14-G 3/8"-wd	17,18
S	630	14	G 1/2"	37,0	19,0	14	27	27	GE-SR-14-G 1/2"-wd	18,71
S	420	14	G 3/4"		19,0	16	32	27	GE-SR-14-G 3/4"-wd	29,40
S	630	16	G 1/4"	38,0	17,5	12	27	30	GE-SR-16-G 1/4"-wd	27,35
S	630	16	G 3/8"		18,0	12	27	30	GE-SR-16-G 3/8"-wd	24,64
S	630	16	G 1/2"	37,0	18,5	14	27	30	GE-SR-16-G 1/2"-wd	24,54
S	420	16	G 3/4"	39,0	20,5	16	32	30	GE-SR-16-G 3/4"-wd	30,93
S	420	16	G 1"	43,5	22,5	18	41	30	GE-SR-16-G 1"-wd	42,59
S	420	20	G 3/8"		18,0	12	32	36	GE-SR-20-G 3/8"-wd	37,07
S	420	20	G 1/2"		20,5	14	32	36	GE-SR-20-G 1/2"-wd	34,51
S	420	20	G 3/4"	42,0	20,5	16	32	36	GE-SR-20-G 3/4"-wd	31,60
S	420	20	G 1"		22,5	18	41	36	GE-SR-20-G 1"-wd	42,59
S	420	20	G 1 1/4"		22,5	20	50	36	GE-SR-20-G 1 1/4"-wd	49,08
S	420	25	G 1/2"		23,0	14	41	46	GE-SR-25-G 1/2"-wd	54,15
S	420	25	G 3/4"		23,0	16	41	46	GE-SR-25-G 3/4"-wd	52,59
S	420	25	G 1"	47,0	23,0	18	41	46	GE-SR-25-G 1"-wd	52,15
S	420	25	G 1 1/4"		23,0	20	50	46	GE-SR-25-G 1 1/4"-wd	59,18
S	420	30	G 3/4"		25,5	16	46	50	GE-SR-30-G 3/4"-wd	64,37
S	420	30	G 1"	50,0	23,5	18	46	50	GE-SR-30-G 1"-wd	61,41
S	420	30	G 1 1/4"	50,0	23,5	20	50	50	GE-SR-30-G 1 1/4"-wd	61,61
S	420	30	G 1 1/2"	50,0	23,5	22	55	50	GE-SR-30-G 1 1/2"-wd	70,87
S	420	38	G 1"	42,0	26,0	18	46	50	GE-SR-38-G 1"-wd	91,01
S	420	38	G 1 1/4"		23,0	20	55	60	GE-SR-38-G 1 1/4"-wd	77,64
S	420	38	G 1 1/2"	57,0	26,0	22	55	60	GE-SR-38-G 1 1/2"-wd	78,02
S	250	38	G 2"				70	60	GE-SR-38-G 2"-wd	*

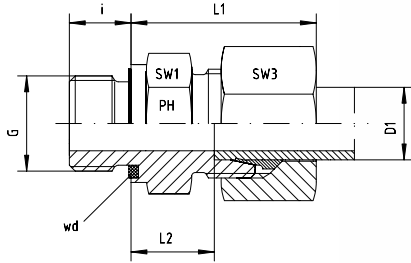

Gerade Einschraubverschraubungen

S-Reihe

Einschraubgewinde: Whitworth-Rohrgewinde - Zylindrisch
wd = Abdichtung durch Profildichtung - Viton

Male Stud Couplings

S-Series

Thread: BSP - Parallel

wd = Sealing by an Elastomer Profiled Ring - Viton

Reihe Series	Druck Pressure PN	Rohr A.D. Tube O.D. D1	Gewinde Thread G	Ca. Maße Approx. Dimensions					Bestellzeichen Order-Code SC	Brutto-Preis Gross-Price Euro (€)
				L1	L2	i	SW1	SW3		
S	800	6	G 1/8"	28,0	13,0	8		17	GE-SR-06-G 1/8"-wd-SC	11,28
S	800	6	G 1/4"	28,0	13,0	12	19	17	GE-SR-06-G 1/4"-wd-SC	11,28
S	800	6	G 3/8"	30,0	15,5	12	22	19	GE-SR-06-G 3/8"-wd-SC	13,53
S	630	6	G 1/2"	34,0	17,0	14	27	19	GE-SR-06-G 1/2"-wd-SC	17,67
S	800	8	G 1/8"		14,0	8	17	19	GE-SR-08-G 1/8"-wd-SC	12,92
S	800	8	G 1/4"	30,0	15,0	12	19	19	GE-SR-08-G 1/4"-wd-SC	10,97
S	800	8	G 3/8"		15,5	12	22	19	GE-SR-08-G 3/8"-wd-SC	12,28
S	630	8	G 1/2"		15,0	14	27	19	GE-SR-08-G 1/2"-wd-SC	17,82
S	800	10	G 1/8"		13,5	8	19	22	GE-SR-10-G 1/8"-wd-SC	15,64
S	800	10	G 1/4"		14,5	12	19	22	GE-SR-10-G 1/4"-wd-SC	13,85
S	800	10	G 3/8"	31,0	15,0	12	22	22	GE-SR-10-G 3/8"-wd-SC	13,55
S	630	10	G 1/2"		13,5	14	27	22	GE-SR-10-G 1/2"-wd-SC	18,40
S	420	10	G 3/4"	36,0	17,5	16	32	22	GE-SR-10-G 3/4"-wd-SC	29,45
S	630	12	G 1/4"		16,5	12	22	24	GE-SR-12-G 1/4"-wd-SC	15,74
S	630	12	G 3/8"	33,0	17,0	12	22	24	GE-SR-12-G 3/8"-wd-SC	14,75
S	630	12	G 1/2"	34,0	17,5	14	27	24	GE-SR-12-G 1/2"-wd-SC	20,47
S	420	12	G 3/4"	36,0	17,5	16	32	24	GE-SR-12-G 3/4"-wd-SC	30,24
S	630	14	G 1/4"	37,0	17,0	12	24	27	GE-SR-14-G 1/4"-wd-SC	30,91
S	630	14	G 3/8"		17,0	12	24	27	GE-SR-14-G 3/8"-wd-SC	18,74
S	630	14	G 1/2"	37,0	19,0	14	27	27	GE-SR-14-G 1/2"-wd-SC	20,27
S	420	14	G 3/4"		19,0	16	32	27	GE-SR-14-G 3/4"-wd-SC	30,96
S	630	16	G 1/4"	38,0	17,5	12	27	30	GE-SR-16-G 1/4"-wd-SC	28,91
S	630	16	G 3/8"		18,0	12	27	30	GE-SR-16-G 3/8"-wd-SC	26,20
S	630	16	G 1/2"	37,0	18,5	14	27	30	GE-SR-16-G 1/2"-wd-SC	26,10
S	420	16	G 3/4"	39,0	20,5	16	32	30	GE-SR-16-G 3/4"-wd-SC	32,49
S	420	16	G 1"	43,5	22,5	18	41	30	GE-SR-16-G 1"-wd-SC	44,15
S	420	20	G 3/8"		18,0	12	32	36	GE-SR-20-G 3/8"-wd-SC	38,95
S	420	20	G 1/2"		20,5	14	32	36	GE-SR-20-G 1/2"-wd-SC	36,39
S	420	20	G 3/4"	42,0	20,5	16	32	36	GE-SR-20-G 3/4"-wd-SC	33,48
S	420	20	G 1"		22,5	18	41	36	GE-SR-20-G 1"-wd-SC	44,47
S	420	20	G 1 1/4"		22,5	20	50	36	GE-SR-20-G 1 1/4"-wd-SC	50,96
S	420	25	G 1/2"		23,0	14	41	46	GE-SR-25-G 1/2"-wd-SC	57,15
S	420	25	G 3/4"		23,0	16	41	46	GE-SR-25-G 3/4"-wd-SC	55,59
S	420	25	G 1"	47,0	23,0	18	41	46	GE-SR-25-G 1"-wd-SC	55,15
S	420	25	G 1 1/4"		23,0	20	50	46	GE-SR-25-G 1 1/4"-wd-SC	62,18
S	420	30	G 3/4"		25,5	16	46	50	GE-SR-30-G 3/4"-wd-SC	68,53
S	420	30	G 1"	50,0	23,5	18	46	50	GE-SR-30-G 1"-wd-SC	65,57
S	420	30	G 1 1/4"	50,0	23,5	20	50	50	GE-SR-30-G 1 1/4"-wd-SC	65,77
S	420	30	G 1 1/2"	50,0	23,5	22	55	50	GE-SR-30-G 1 1/2"-wd-SC	75,03
S	420	38	G 1"	42,0	26,0	18	46	50	GE-SR-38-G 1"-wd-SC	96,65
S	420	38	G 1 1/4"		23,0	20	55	60	GE-SR-38-G 1 1/4"-wd-SC	83,28
S	420	38	G 1 1/2"	57,0	26,0	22	55	60	GE-SR-38-G 1 1/2"-wd-SC	83,66
S	250	38	G 2"				70	60	GE-SR-38-G 2"-wd-SC	*



Gerade Einschraubverschraubungsstutzen
S-Reihe

Einschraubgewinde: Whitworth-Rohrgewinde - Zylindrisch
wd = Abdichtung durch Profildichtung - Viton

Male Stud Coupling Bodies

S-Series

Thread: BSP - Parallel

wd = Sealing by an Elastomer Profiled Ring - Viton

Reihe Series	Druck Pressure PN	Rohr A.D. Tube O.D. D1	Gewinde Thread G	Ca. Maße Approx. Dimensions					Bestellzeichen Order-Code OMD	Brutto-Preis Gross-Price Euro (€)
S	800	6	G 1/8"						GE-SR-06-G 1/8"-wd-OMD	8,05
S	800	6	G 1/4"						GE-SR-06-G 1/4"-wd-OMD	8,05
S	800	6	G 3/8"						GE-SR-06-G 3/8"-wd-OMD	10,30
S	630	6	G 1/2"						GE-SR-06-G 1/2"-wd-OMD	14,44
S	800	8	G 1/8"						GE-SR-08-G 1/8"-wd-OMD	9,28
S	800	8	G 1/4"						GE-SR-08-G 1/4"-wd-OMD	7,33
S	800	8	G 3/8"						GE-SR-08-G 3/8"-wd-OMD	8,64
S	630	8	G 1/2"						GE-SR-08-G 1/2"-wd-OMD	14,18
S	800	10	G 1/8"						GE-SR-10-G 1/8"-wd-OMD	11,14
S	800	10	G 1/4"						GE-SR-10-G 1/4"-wd-OMD	9,35
S	800	10	G 3/8"						GE-SR-10-G 3/8"-wd-OMD	9,05
S	630	10	G 1/2"						GE-SR-10-G 1/2"-wd-OMD	13,90
S	420	10	G 3/4"						GE-SR-10-G 3/4"-wd-OMD	24,95
S	630	12	G 1/4"						GE-SR-12-G 1/4"-wd-OMD	10,45
S	630	12	G 3/8"						GE-SR-12-G 3/8"-wd-OMD	9,46
S	630	12	G 1/2"						GE-SR-12-G 1/2"-wd-OMD	15,18
S	420	12	G 3/4"						GE-SR-12-G 3/4"-wd-OMD	24,95
S	630	14	G 1/4"						GE-SR-14-G 1/4"-wd-OMD	23,85
S	630	14	G 3/8"						GE-SR-14-G 3/8"-wd-OMD	11,68
S	630	14	G 1/2"						GE-SR-14-G 1/2"-wd-OMD	13,21
S	420	14	G 3/4"						GE-SR-14-G 3/4"-wd-OMD	23,90
S	630	16	G 1/4"						GE-SR-16-G 1/4"-wd-OMD	19,14
S	630	16	G 3/8"						GE-SR-16-G 3/8"-wd-OMD	16,43
S	630	16	G 1/2"						GE-SR-16-G 1/2"-wd-OMD	16,33
S	420	16	G 3/4"						GE-SR-16-G 3/4"-wd-OMD	22,72
S	420	16	G 1"						GE-SR-16-G 1"-wd-OMD	34,38
S	420	20	G 3/8"						GE-SR-20-G 3/8"-wd-OMD	26,49
S	420	20	G 1/2"						GE-SR-20-G 1/2"-wd-OMD	23,93
S	420	20	G 3/4"						GE-SR-20-G 3/4"-wd-OMD	21,02
S	420	20	G 1"						GE-SR-20-G 1"-wd-OMD	32,01
S	420	20	G 1 1/4"						GE-SR-20-G 1 1/4"-wd-OMD	38,50
S	420	25	G 1/2"						GE-SR-25-G 1/2"-wd-OMD	35,53
S	420	25	G 3/4"						GE-SR-25-G 3/4"-wd-OMD	33,97
S	420	25	G 1"						GE-SR-25-G 1"-wd-OMD	33,53
S	420	25	G 1 1/4"						GE-SR-25-G 1 1/4"-wd-OMD	40,56
S	420	30	G 3/4"						GE-SR-30-G 3/4"-wd-OMD	40,93
S	420	30	G 1"						GE-SR-30-G 1"-wd-OMD	37,97
S	420	30	G 1 1/4"						GE-SR-30-G 1 1/4"-wd-OMD	38,17
S	420	30	G 1 1/2"						GE-SR-30-G 1 1/2"-wd-OMD	47,43
S	420	38	G 1"						GE-SR-38-G 1"-wd-OMD	59,20
S	420	38	G 1 1/4"						GE-SR-38-G 1 1/4"-wd-OMD	45,83
S	420	38	G 1 1/2"						GE-SR-38-G 1 1/2"-wd-OMD	46,21
S	250	38	G 2"						GE-SR-38-G 2"-wd-OMD	*

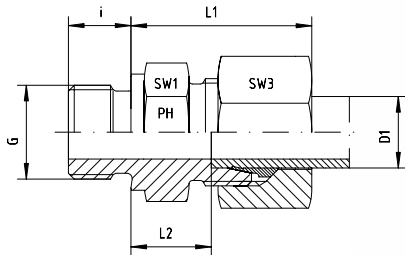

Gerade Einschraubverschraubungen

L-Reihe

Einschraubgewinde: Metrisches Feingewinde - Zylindrisch
Abdichtung durch Dichtkante Form B

Male Stud Couplings

L-Series

Thread: Metric - Parallel

Sealing by Sealing Shoulder Form B

Reihe Series	Druck Pressure PN	Rohr A.D. Tube O.D. D1	Gewinde Thread G	Ca. Maße Approx. Dimensions					Bestellzeichen Order-Code Standard	Brutto-Preis Gross-Price Euro (€)
				L1	L2	i	SW1	SW3		
L	315	6	M 10 x 1	23,0	8,5	8	14	14	GE-L-06-M 10x1	5,88
L	315	6	M 12 x 1,5		10,0	12	17	14	GE-L-06-M 12x1,5	8,44
L	315	6	M 14 x 1,5	27,0	10,0	12	19	14	GE-L-06-M 14x1,5	8,95
L	315	8	M 10 x 1	26,0	9,5	8	17	17	GE-L-08-M 10x1	8,45
L	315	8	M 12 x 1,5	25,0	10,0	12	17	17	GE-L-08-M 12x1,5	7,87
L	315	8	M 14 x 1,5	27,0	10,0	12	19	17	GE-L-08-M 14x1,5	9,15
L	315	8	M 16 x 1,5	27,5	11,5	12	22	17	GE-L-08-M 16x1,5	11,50
L	315	8	M 18 x 1,5	27,5	11,5	12	24	17	GE-L-08-M 18x1,5	14,55
L	315	10	M 10 x 1		11,0	8	17	19	GE-L-10-M 10x1	11,20
L	315	10	M 12 x 1,5	28,5	11,5	12	17	19	GE-L-10-M 12x1,5	10,51
L	315	10	M 14 x 1,5	26,0	11,0	12	19	19	GE-L-10-M 14x1,5	8,33
L	315	10	M 16 x 1,5	30,0	12,5	12	22	19	GE-L-10-M 16x1,5	12,02
L	315	10	M 18 x 1,5	30,0	12,5	12	24	19	GE-L-10-M 18x1,5	14,57
L	315	10	M 22 x 1,5		14,0	14	27	19	GE-L-10-M 22x1,5	20,45
L	315	12	M 12 x 1,5	28,0	13,0	12	19	22	GE-L-12-M 12x1,5	11,50
L	315	12	M 14 x 1,5	28,0	12,5	12	19	22	GE-L-12-M 14x1,5	11,40
L	315	12	M 16 x 1,5	27,0	12,5	12	22	22	GE-L-12-M 16x1,5	10,94
L	315	12	M 18 x 1,5	30,0	12,5	12	24	22	GE-L-12-M 18x1,5	14,57
L	315	12	M 22 x 1,5		14,0	14	27	22	GE-L-12-M 22x1,5	20,71
L	315	15	M 16 x 1,5	32,0	13,5	12	24	27	GE-L-15-M 16x1,5	14,78
L	315	15	M 18 x 1,5	29,0	13,5	12	24	27	GE-L-15-M 18x1,5	14,29
L	315	15	M 22 x 1,5	33,0	15,0	14	27	27	GE-L-15-M 22x1,5	20,71
L	315	18	M 18 x 1,5	33,0	14,0	12	27	32	GE-L-18-M 18x1,5	21,37
L	315	18	M 22 x 1,5	31,0	14,5	14	27	32	GE-L-18-M 22x1,5	20,67
L	160	18	M 26 x 1,5		14,5	16	32	32	GE-L-18-M 26x1,5	28,48
L	160	22	M 22 x 1,5	38,0	17,5	14	32	36	GE-L-22-M 22x1,5	31,50
L	160	22	M 26 x 1,5	33,0	16,5	16	32	36	GE-L-22-M 26x1,5	27,20
L	160	28	M 33 x 2	34,0	17,5	18	41	41	GE-L-28-M 33x2	43,20
L	160	35	M 42 x 2	39,0	17,5	20	50	50	GE-L-35-M 42x2	53,69
L	160	42	M 48 x 2	42,0	19,0	22	55	60	GE-L-42-M 48x2	71,58

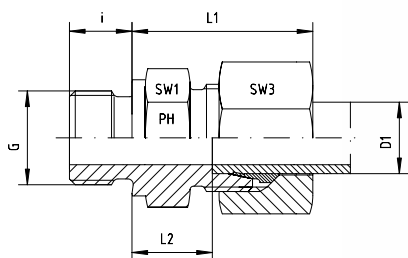

Gerade Einschraubverschraubungen

L-Reihe

Einschraubgewinde: Metrisches Feingewinde - Zylindrisch
Abdichtung durch Dichtkante Form B

Male Stud Couplings

L-Series

Thread: Metric - Parallel

Sealing by Sealing Shoulder Form B

Reihe Series	Druck Pressure PN	Rohr A.D. Tube O.D. D1	Gewinde Thread G	Ca. Maße Approx. Dimensions					Bestellzeichen Order-Code SC	Brutto-Preis Gross-Price Euro (€)
				L1	L2	i	SW1	SW3		
L	315	6	M 10 x 1	23,0	8,5	8	14	14	GE-L-06-M 10x1-SC	6,20
L	315	6	M 12 x 1,5		10,0	12	17	14	GE-L-06-M 12x1,5-SC	8,76
L	315	6	M 14 x 1,5	27,0	10,0	12	19	14	GE-L-06-M 14x1,5-SC	9,27
L	315	8	M 10 x 1	26,0	9,5	8	17	17	GE-L-08-M 10x1-SC	8,89
L	315	8	M 12 x 1,5	25,0	10,0	12	17	17	GE-L-08-M 12x1,5-SC	8,31
L	315	8	M 14 x 1,5	27,0	10,0	12	19	17	GE-L-08-M 14x1,5-SC	9,59
L	315	8	M 16 x 1,5	27,5	11,5	12	22	17	GE-L-08-M 16x1,5-SC	11,94
L	315	8	M 18 x 1,5	27,5	11,5	12	24	17	GE-L-08-M 18x1,5-SC	14,99
L	315	10	M 10 x 1		11,0	8	17	19	GE-L-10-M 10x1-SC	11,64
L	315	10	M 12 x 1,5	28,5	11,5	12	17	19	GE-L-10-M 12x1,5-SC	10,95
L	315	10	M 14 x 1,5	26,0	11,0	12	19	19	GE-L-10-M 14x1,5-SC	8,77
L	315	10	M 16 x 1,5	30,0	12,5	12	22	19	GE-L-10-M 16x1,5-SC	12,46
L	315	10	M 18 x 1,5	30,0	12,5	12	24	19	GE-L-10-M 18x1,5-SC	15,01
L	315	10	M 22 x 1,5		14,0	14	27	19	GE-L-10-M 22x1,5-SC	20,89
L	315	12	M 12 x 1,5	28,0	13,0	12	19	22	GE-L-12-M 12x1,5-SC	12,06
L	315	12	M 14 x 1,5	28,0	12,5	12	19	22	GE-L-12-M 14x1,5-SC	11,96
L	315	12	M 16 x 1,5	27,0	12,5	12	22	22	GE-L-12-M 16x1,5-SC	11,50
L	315	12	M 18 x 1,5	30,0	12,5	12	24	22	GE-L-12-M 18x1,5-SC	15,13
L	315	12	M 22 x 1,5		14,0	14	27	22	GE-L-12-M 22x1,5-SC	21,27
L	315	15	M 16 x 1,5	32,0	13,5	12	24	27	GE-L-15-M 16x1,5-SC	15,86
L	315	15	M 18 x 1,5	29,0	13,5	12	24	27	GE-L-15-M 18x1,5-SC	15,37
L	315	15	M 22 x 1,5	33,0	15,0	14	27	27	GE-L-15-M 22x1,5-SC	21,79
L	315	18	M 18 x 1,5	33,0	14,0	12	27	32	GE-L-18-M 18x1,5-SC	23,01
L	315	18	M 22 x 1,5	31,0	14,5	14	27	32	GE-L-18-M 22x1,5-SC	22,31
L	160	18	M 26 x 1,5		14,5	16	32	32	GE-L-18-M 26x1,5-SC	30,12
L	160	22	M 22 x 1,5	38,0	17,5	14	32	36	GE-L-22-M 22x1,5-SC	33,26
L	160	22	M 26 x 1,5	33,0	16,5	16	32	36	GE-L-22-M 26x1,5-SC	28,96
L	160	28	M 33 x 2	34,0	17,5	18	41	41	GE-L-28-M 33x2-SC	45,20
L	160	35	M 42 x 2	39,0	17,5	20	50	50	GE-L-35-M 42x2-SC	57,41
L	160	42	M 48 x 2	42,0	19,0	22	55	60	GE-L-42-M 48x2-SC	75,90



Gerade Einschraubverschraubungsstutzen

L-Reihe

Einschraubgewinde: Metrisches Feingewinde - Zylindrisch
Abdichtung durch Dichtkante Form B

Male Stud Coupling Bodies

L-Series

Thread: Metric - Parallel

Sealing by Sealing Shoulder Form B

Reihe Series	Druck Pressure PN	Rohr A.D. Tube O.D. D1	Gewinde Thread G	Ca. Maße Approx. Dimensions				Bestellzeichen Order-Code OMD	Brutto-Preis Gross-Price Euro (€)
L	315	6	M 10 x 1					GE-L-06-M 10x1-OMD	3,57
L	315	6	M 12 x 1,5					GE-L-06-M 12x1,5-OMD	6,13
L	315	6	M 14 x 1,5					GE-L-06-M 14x1,5-OMD	6,64
L	315	8	M 10 x 1					GE-L-08-M 10x1-OMD	5,65
L	315	8	M 12 x 1,5					GE-L-08-M 12x1,5-OMD	5,07
L	315	8	M 14 x 1,5					GE-L-08-M 14x1,5-OMD	6,35
L	315	8	M 16 x 1,5					GE-L-08-M 16x1,5-OMD	8,70
L	315	8	M 18 x 1,5					GE-L-08-M 18x1,5-OMD	11,75
L	315	10	M 10 x 1					GE-L-10-M 10x1-OMD	7,84
L	315	10	M 12 x 1,5					GE-L-10-M 12x1,5-OMD	7,15
L	315	10	M 14 x 1,5					GE-L-10-M 14x1,5-OMD	4,97
L	315	10	M 16 x 1,5					GE-L-10-M 16x1,5-OMD	8,66
L	315	10	M 18 x 1,5					GE-L-10-M 18x1,5-OMD	11,21
L	315	10	M 22 x 1,5					GE-L-10-M 22x1,5-OMD	17,09
L	315	12	M 12 x 1,5					GE-L-12-M 12x1,5-OMD	7,61
L	315	12	M 14 x 1,5					GE-L-12-M 14x1,5-OMD	7,51
L	315	12	M 16 x 1,5					GE-L-12-M 16x1,5-OMD	7,05
L	315	12	M 18 x 1,5					GE-L-12-M 18x1,5-OMD	10,68
L	315	12	M 22 x 1,5					GE-L-12-M 22x1,5-OMD	16,82
L	315	15	M 16 x 1,5					GE-L-15-M 16x1,5-OMD	9,64
L	315	15	M 18 x 1,5					GE-L-15-M 18x1,5-OMD	9,15
L	315	15	M 22 x 1,5					GE-L-15-M 22x1,5-OMD	15,57
L	315	18	M 18 x 1,5					GE-L-18-M 18x1,5-OMD	12,75
L	315	18	M 22 x 1,5					GE-L-18-M 22x1,5-OMD	12,05
L	160	18	M 26 x 1,5					GE-L-18-M 26x1,5-OMD	19,86
L	160	22	M 22 x 1,5					GE-L-22-M 22x1,5-OMD	21,19
L	160	22	M 26 x 1,5					GE-L-22-M 26x1,5-OMD	16,89
L	160	28	M 33 x 2					GE-L-28-M 33x2-OMD	28,35
L	160	35	M 42 x 2					GE-L-35-M 42x2-OMD	32,58
L	160	42	M 48 x 2					GE-L-42-M 48x2-OMD	44,15

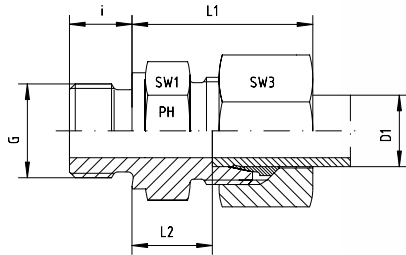

Gerade Einschraubverschraubungen

S-Reihe

Einschraubgewinde: Metrisches Feingewinde - Zylindrisch
Abdichtung durch Dichtkante Form B

Male Stud Couplings

S-Series

Thread: Metric - Parallel

Sealing by Sealing Shoulder Form B

Reihe Series	Druck Pressure PN	Rohr A.D. Tube O.D. D1	Gewinde Thread G	Ca. Maße Approx. Dimensions					Bestellzeichen Order-Code Standard	Brutto-Preis Gross-Price Euro (€)
				L1	L2	i	SW1	SW3		
S	630	6	M 12 x 1,5	28,0	13,0	12	17	17	GE-S-06-M 12x1,5	9,71
S	630	6	M 14 x 1,5			12	19	17	GE-S-06-M 14x1,5	10,61
S	630	8	M 12 x 1,5	32,0	15,0	12	17	19	GE-S-08-M 12x1,5	*
S	630	8	M 14 x 1,5	30,0	15,0	12	19	19	GE-S-08-M 14x1,5	11,22
S	630	8	M 16 x 1,5			12	22	19	GE-S-08-M 16x1,5	*
S	630	10	M 14 x 1,5			12	19	22	GE-S-10-M 14x1,5	*
S	630	10	M 16 x 1,5	31,0	15,0	12	22	22	GE-S-10-M 16x1,5	12,35
S	630	10	M 18 x 1,5	31,0	15,0	12	24	22	GE-S-10-M 18x1,5	14,29
S	630	12	M 12 x 1,5	33,5	16,5	12	22	24	GE-S-12-M 12x1,5	16,50
S	630	12	M 14 x 1,5	33,0	16,0	12	22	24	GE-S-12-M 14x1,5	15,50
S	630	12	M 16 x 1,5	35,5	17,0	12	22	24	GE-S-12-M 16x1,5	15,50
S	630	12	M 18 x 1,5	33,0	17,0	12	24	24	GE-S-12-M 18x1,5	13,29
S	630	12	M 20 x 1,5			14	27	24	GE-S-12-M 20x1,5	*
S	400	12	M 22 x 1,5	36,5	17,5	14	27	24	GE-S-12-M 22x1,5	16,50
S	630	14	M 20 x 1,5	37,0	19,0	14	27	27	GE-S-14-M 20x1,5	16,59
S	400	14	M 22 x 1,5			14	27	27	GE-S-14-M 22x1,5	*
S	400	16	M 18 x 1,5		18,0	12	27	30	GE-S-16-M 18x1,5	23,26
S	400	16	M 22 x 1,5	37,0	18,5	14	27	30	GE-S-16-M 22x1,5	20,96
S	400	20	M 27 x 2	42,5	20,5	16	32	36	GE-S-20-M 27x2	28,79
S	400	25	M 33 x 2	47,0	23,0	18	41	46	GE-S-25-M 33x2	49,47
S	250	30	M 42 x 2	50,0	23,5	20	50	50	GE-S-30-M 42x2	57,52
S	250	38	M 48 x 2	57,0	26,0	22	55	60	GE-S-38-M 48x2	74,65

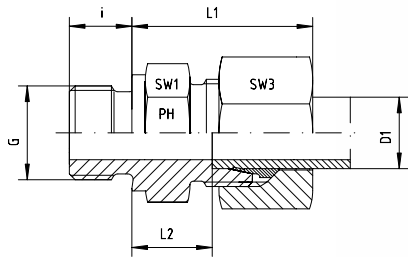

Gerade Einschraubverschraubungen

S-Reihe

Einschraubgewinde: Metrisches Feingewinde - Zylindrisch
Abdichtung durch Dichtkante Form B

Male Stud Couplings

S-Series

Thread: Metric - Parallel

Sealing by Sealing Shoulder Form B

Reihe Series	Druck Pressure PN	Rohr A.D. Tube O.D. D1	Gewinde Thread G	Ca. Maße Approx. Dimensions					Bestellzeichen Order-Code SC	Brutto-Preis Gross-Price Euro (€)
				L1	L2	i	SW1	SW3		
S	630	6	M 12 x 1,5	28,0	13,0	12	17	17	GE-S-06-M 12x1,5-SC	10,15
S	630	6	M 14 x 1,5			12	19	17	GE-S-06-M 14x1,5-SC	11,05
S	630	8	M 12 x 1,5	32,0	15,0	12	17	19	GE-S-08-M 12x1,5-SC	*
S	630	8	M 14 x 1,5	30,0	15,0	12	19	19	GE-S-08-M 14x1,5-SC	11,66
S	630	8	M 16 x 1,5			12	22	19	GE-S-08-M 16x1,5-SC	*
S	630	10	M 14 x 1,5			12	19	22	GE-S-10-M 14x1,5-SC	*
S	630	10	M 16 x 1,5	31,0	15,0	12	22	22	GE-S-10-M 16x1,5-SC	12,91
S	630	10	M 18 x 1,5	31,0	15,0	12	24	22	GE-S-10-M 18x1,5-SC	15,13
S	630	12	M 12 x 1,5	33,5	16,5	12	22	24	GE-S-12-M 12x1,5-SC	17,34
S	630	12	M 14 x 1,5	33,0	16,0	12	22	24	GE-S-12-M 14x1,5-SC	16,34
S	630	12	M 16 x 1,5	35,5	17,0	12	22	24	GE-S-12-M 16x1,5-SC	16,34
S	630	12	M 18 x 1,5	33,0	17,0	12	24	24	GE-S-12-M 18x1,5-SC	14,13
S	630	12	M 20 x 1,5			14	27	24	GE-S-12-M 20x1,5-SC	*
S	400	12	M 22 x 1,5	36,5	17,5	14	27	24	GE-S-12-M 22x1,5-SC	17,34
S	630	14	M 20 x 1,5	37,0	19,0	14	27	27	GE-S-14-M 20x1,5-SC	18,15
S	400	14	M 22 x 1,5			14	27	27	GE-S-14-M 22x1,5-SC	*
S	400	16	M 18 x 1,5		18,0	12	27	30	GE-S-16-M 18x1,5-SC	24,82
S	400	16	M 22 x 1,5	37,0	18,5	14	27	30	GE-S-16-M 22x1,5-SC	22,52
S	400	20	M 27 x 2	42,5	20,5	16	32	36	GE-S-20-M 27x2-SC	30,67
S	400	25	M 33 x 2	47,0	23,0	18	41	46	GE-S-25-M 33x2-SC	52,47
S	250	30	M 42 x 2	50,0	23,5	20	50	50	GE-S-30-M 42x2-SC	61,68
S	250	38	M 48 x 2	57,0	26,0	22	55	60	GE-S-38-M 48x2-SC	80,29



Gerade Einschraubverschraubungsstutzen

S-Reihe

Einschraubgewinde: Metrisches Feingewinde - Zylindrisch
Abdichtung durch Dichtkante Form B

Male Stud Coupling Bodies

S-Series

Thread: Metric - Parallel

Sealing by Sealing Shoulder Form B

Reihe Series	Druck Pressure PN	Rohr A.D. Tube O.D. D1	Gewinde Thread G	Ca. Maße Approx. Dimensions					Bestellzeichen Order-Code OMD	Brutto-Preis Gross-Price Euro (€)
S	630	6	M 12 x 1,5						GE-S-06-M 12x1,5-OMD	6,92
S	630	6	M 14 x 1,5						GE-S-06-M 14x1,5-OMD	7,82
S	630	8	M 12 x 1,5						GE-S-08-M 12x1,5-OMD	*
S	630	8	M 14 x 1,5						GE-S-08-M 14x1,5-OMD	8,02
S	630	8	M 16 x 1,5						GE-S-08-M 16x1,5-OMD	*
S	630	10	M 14 x 1,5						GE-S-10-M 14x1,5-OMD	*
S	630	10	M 16 x 1,5						GE-S-10-M 16x1,5-OMD	8,41
S	630	10	M 18 x 1,5						GE-S-10-M 18x1,5-OMD	9,84
S	630	12	M 12 x 1,5						GE-S-12-M 12x1,5-OMD	12,05
S	630	12	M 14 x 1,5						GE-S-12-M 14x1,5-OMD	11,05
S	630	12	M 16 x 1,5						GE-S-12-M 16x1,5-OMD	11,05
S	630	12	M 18 x 1,5						GE-S-12-M 18x1,5-OMD	8,84
S	630	12	M 20 x 1,5						GE-S-12-M 20x1,5-OMD	*
S	400	12	M 22 x 1,5						GE-S-12-M 22x1,5-OMD	12,05
S	630	14	M 20 x 1,5						GE-S-14-M 20x1,5-OMD	11,09
S	400	14	M 22 x 1,5						GE-S-14-M 22x1,5-OMD	*
S	400	16	M 18 x 1,5						GE-S-16-M 18x1,5-OMD	15,05
S	400	16	M 22 x 1,5						GE-S-16-M 22x1,5-OMD	12,75
S	400	20	M 27 x 2						GE-S-20-M 27x2-OMD	18,21
S	400	25	M 33 x 2						GE-S-25-M 33x2-OMD	30,85
S	250	30	M 42 x 2						GE-S-30-M 42x2-OMD	34,08
S	250	38	M 48 x 2						GE-S-38-M 48x2-OMD	42,84

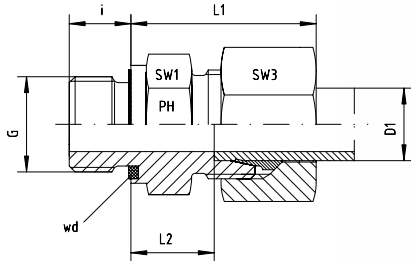

Gerade Einschraubverschraubungen

L-Reihe

Einschraubgewinde: Metrisches Feingewinde - Zylindrisch
wd = Abdichtung durch Profildichtung - Viton

Male Stud Couplings

L-Series

Thread: Metric - Parallel

wd = Sealing by an Elastomer Profiled Ring - Viton

Reihe Series	Druck Pressure PN	Rohr A.D. Tube O.D. D1	Gewinde Thread G	Ca. Maße Approx. Dimensions					Bestellzeichen Order-Code Standard	Brutto-Preis Gross-Price Euro (€)
				L1	L2	i	SW1	SW3		
LL	100	8	M 10 x 1		9,0	8	14	14	GE-LL-08-M 10x1-wd	13,80

Reihe Series	Druck Pressure PN	Rohr A.D. Tube O.D. D1	Gewinde Thread G	Ca. Maße Approx. Dimensions					Bestellzeichen Order-Code Standard	Brutto-Preis Gross-Price Euro (€)
				L1	L2	i	SW1	SW3		
L	500	6	M 10 x 1	23,0	8,5	8	14	14	GE-L-06-M 10x1-wd	7,93
L	500	6	M 12 x 1,5		10,0	12	17	14	GE-L-06-M 12x1,5-wd	10,44
L	500	6	M 14 x 1,5	27,0	10,0	12	19	14	GE-L-06-M 14x1,5-wd	10,95
L	500	8	M 10 x 1	26,0	9,5	8	17	17	GE-L-08-M 10x1-wd	10,98
L	500	8	M 12 x 1,5	25,0	10,0	12	17	17	GE-L-08-M 12x1,5-wd	9,92
L	500	8	M 14 x 1,5	27,0	10,0	12	19	17	GE-L-08-M 14x1,5-wd	11,15
L	400	8	M 16 x 1,5	27,5	11,5	12	22	17	GE-L-08-M 16x1,5-wd	13,98
L	400	8	M 18 x 1,5	27,5	11,5	12	24	17	GE-L-08-M 18x1,5-wd	16,90
L	500	10	M 10 x 1		11,0	8	17	19	GE-L-10-M 10x1-wd	13,20
L	500	10	M 12 x 1,5	28,5	11,5	12	17	19	GE-L-10-M 12x1,5-wd	14,06
L	500	10	M 14 x 1,5	26,0	11,0	12	19	19	GE-L-10-M 14x1,5-wd	10,38
L	400	10	M 16 x 1,5	30,0	12,5	12	22	19	GE-L-10-M 16x1,5-wd	15,70
L	400	10	M 18 x 1,5	30,0	12,5	12	24	19	GE-L-10-M 18x1,5-wd	16,57
L	400	10	M 22 x 1,5		14,0	14	27	19	GE-L-10-M 22x1,5-wd	22,95
L	400	12	M 12 x 1,5	28,0	13,0	12	19	22	GE-L-12-M 12x1,5-wd	15,50
L	400	12	M 14 x 1,5	28,0	12,5	12	19	22	GE-L-12-M 14x1,5-wd	15,40
L	400	12	M 16 x 1,5	27,0	12,5	12	22	22	GE-L-12-M 16x1,5-wd	12,99
L	400	12	M 18 x 1,5	30,0	12,5	12	24	22	GE-L-12-M 18x1,5-wd	17,07
L	400	12	M 22 x 1,5		14,0	14	27	22	GE-L-12-M 22x1,5-wd	23,21
L	400	15	M 16 x 1,5	32,0	13,5	12	24	27	GE-L-15-M 16x1,5-wd	17,28
L	400	15	M 18 x 1,5	29,0	13,5	12	24	27	GE-L-15-M 18x1,5-wd	16,34
L	400	15	M 22 x 1,5	33,0	15,0	14	27	27	GE-L-15-M 22x1,5-wd	23,21
L	400	18	M 18 x 1,5	33,0	14,0	12	27	32	GE-L-18-M 18x1,5-wd	23,87
L	400	18	M 22 x 1,5	31,0	14,5	14	27	32	GE-L-18-M 22x1,5-wd	22,70
L	250	18	M 26 x 1,5		14,5	16	32	32	GE-L-18-M 26x1,5-wd	32,90
L	250	22	M 22 x 1,5	38,0	17,5	14	32	36	GE-L-22-M 22x1,5-wd	35,50
L	250	22	M 26 x 1,5	33,0	16,5	16	32	36	GE-L-22-M 26x1,5-wd	30,93
L	250	28	M 33 x 2	34,0	17,5	18	41	41	GE-L-28-M 33x2-wd	45,38
L	250	35	M 42 x 2	39,0	17,5	20	50	50	GE-L-35-M 42x2-wd	54,45
L	250	42	M 48 x 2	42,0	19,0	22	55	60	GE-L-42-M 48x2-wd	76,69

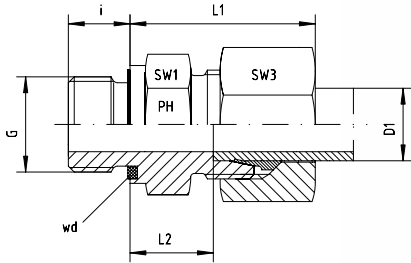

Gerade Einschraubverschraubungen

L-Reihe

Einschraubgewinde: Metrisches Feingewinde - Zylindrisch
wd = Abdichtung durch Profildichtung - Viton

Male Stud Couplings

L-Series

Thread: Metric - Parallel

wd = Sealing by an Elastomer Profiled Ring - Viton

Reihe Series	Druck Pressure PN	Rohr A.D. Tube O.D. D1	Gewinde Thread G	Ca. Maße Approx. Dimensions					Bestellzeichen Order-Code SC	Brutto-Preis Gross-Price Euro (€)
				L1	L2	i	SW1	SW3		
L	500	6	M 10 x 1	23,0	8,5	8	14	14	GE-L-06-M 10x1-wd-SC	8,25
L	500	6	M 12 x 1,5		10,0	12	17	14	GE-L-06-M 12x1,5-wd-SC	10,76
L	500	6	M 14 x 1,5	27,0	10,0	12	19	14	GE-L-06-M 14x1,5-wd-SC	11,27
L	500	8	M 10 x 1	26,0	9,5	8	17	17	GE-L-08-M 10x1-wd-SC	11,42
L	500	8	M 12 x 1,5	25,0	10,0	12	17	17	GE-L-08-M 12x1,5-wd-SC	10,36
L	500	8	M 14 x 1,5	27,0	10,0	12	19	17	GE-L-08-M 14x1,5-wd-SC	11,59
L	400	8	M 16 x 1,5	27,5	11,5	12	22	17	GE-L-08-M 16x1,5-wd-SC	14,42
L	400	8	M 18 x 1,5	27,5	11,5	12	24	17	GE-L-08-M 18x1,5-wd-SC	17,34
L	500	10	M 10 x 1		11,0	8	17	19	GE-L-10-M 10x1-wd-SC	13,64
L	500	10	M 12 x 1,5	28,5	11,5	12	17	19	GE-L-10-M 12x1,5-wd-SC	14,50
L	500	10	M 14 x 1,5	26,0	11,0	12	19	19	GE-L-10-M 14x1,5-wd-SC	10,82
L	400	10	M 16 x 1,5	30,0	12,5	12	22	19	GE-L-10-M 16x1,5-wd-SC	16,14
L	400	10	M 18 x 1,5	30,0	12,5	12	24	19	GE-L-10-M 18x1,5-wd-SC	17,01
L	400	10	M 22 x 1,5		14,0	14	27	19	GE-L-10-M 22x1,5-wd-SC	23,39
L	400	12	M 12 x 1,5	28,0	13,0	12	19	22	GE-L-12-M 12x1,5-wd-SC	16,06
L	400	12	M 14 x 1,5	28,0	12,5	12	19	22	GE-L-12-M 14x1,5-wd-SC	15,96
L	400	12	M 16 x 1,5	27,0	12,5	12	22	22	GE-L-12-M 16x1,5-wd-SC	13,55
L	400	12	M 18 x 1,5	30,0	12,5	12	24	22	GE-L-12-M 18x1,5-wd-SC	17,63
L	400	12	M 22 x 1,5		14,0	14	27	22	GE-L-12-M 22x1,5-wd-SC	23,77
L	400	15	M 16 x 1,5	32,0	13,5	12	24	27	GE-L-15-M 16x1,5-wd-SC	18,38
L	400	15	M 18 x 1,5	29,0	13,5	12	24	27	GE-L-15-M 18x1,5-wd-SC	17,42
L	400	15	M 22 x 1,5	33,0	15,0	14	27	27	GE-L-15-M 22x1,5-wd-SC	24,29
L	400	18	M 18 x 1,5	33,0	14,0	12	27	32	GE-L-18-M 18x1,5-wd-SC	25,51
L	400	18	M 22 x 1,5	31,0	14,5	14	27	32	GE-L-18-M 22x1,5-wd-SC	24,34
L	250	18	M 26 x 1,5		14,5	16	32	32	GE-L-18-M 26x1,5-wd-SC	*
L	250	22	M 22 x 1,5	38,0	17,5	14	32	36	GE-L-22-M 22x1,5-wd-SC	37,26
L	250	22	M 26 x 1,5	33,0	16,5	16	32	36	GE-L-22-M 26x1,5-wd-SC	32,69
L	250	28	M 33 x 2	34,0	17,5	18	41	41	GE-L-28-M 33x2-wd-SC	47,38
L	250	35	M 42 x 2	39,0	17,5	20	50	50	GE-L-35-M 42x2-wd-SC	58,17
L	250	42	M 48 x 2	42,0	19,0	22	55	60	GE-L-42-M 48x2-wd-SC	81,01



Gerade Einschraubverschraubungsstutzen

L-Reihe

Einschraubgewinde: Metrisches Feingewinde - Zylindrisch

wd = Abdichtung durch Profildichtung - Viton

Male Stud Coupling Bodies

L-Series

Thread: Metric - Parallel

wd = Sealing by an Elastomer Profiled Ring - Viton

Reihe Series	Druck Pressure PN	Rohr A.D. Tube O.D. D1	Gewinde Thread G	Ca. Maße Approx. Dimensions				Bestellzeichen Order-Code OMD	Brutto-Preis Gross-Price Euro (€)
L	500	6	M 10 x 1					GE-L-06-M 10x1-wd-OMD	5,62
L	500	6	M 12 x 1,5					GE-L-06-M 12x1,5-wd-OMD	8,13
L	500	6	M 14 x 1,5					GE-L-06-M 14x1,5-wd-OMD	8,64
L	500	8	M 10 x 1					GE-L-08-M 10x1-wd-OMD	8,18
L	500	8	M 12 x 1,5					GE-L-08-M 12x1,5-wd-OMD	7,12
L	500	8	M 14 x 1,5					GE-L-08-M 14x1,5-wd-OMD	8,35
L	400	8	M 16 x 1,5					GE-L-08-M 16x1,5-wd-OMD	11,18
L	400	8	M 18 x 1,5					GE-L-08-M 18x1,5-wd-OMD	14,10
L	500	10	M 10 x 1					GE-L-10-M 10x1-wd-OMD	10,40
L	500	10	M 12 x 1,5					GE-L-10-M 12x1,5-wd-OMD	10,70
L	500	10	M 14 x 1,5					GE-L-10-M 14x1,5-wd-OMD	7,02
L	400	10	M 16 x 1,5					GE-L-10-M 16x1,5-wd-OMD	12,34
L	400	10	M 18 x 1,5					GE-L-10-M 18x1,5-wd-OMD	13,21
L	400	10	M 22 x 1,5					GE-L-10-M 22x1,5-wd-OMD	19,59
L	400	12	M 12 x 1,5					GE-L-12-M 12x1,5-wd-OMD	11,61
L	400	12	M 14 x 1,5					GE-L-12-M 14x1,5-wd-OMD	11,51
L	400	12	M 16 x 1,5					GE-L-12-M 16x1,5-wd-OMD	9,10
L	400	12	M 18 x 1,5					GE-L-12-M 18x1,5-wd-OMD	13,18
L	400	12	M 22 x 1,5					GE-L-12-M 22x1,5-wd-OMD	19,32
L	400	15	M 16 x 1,5					GE-L-15-M 16x1,5-wd-OMD	12,18
L	400	15	M 18 x 1,5					GE-L-15-M 18x1,5-wd-OMD	11,20
L	400	15	M 22 x 1,5					GE-L-15-M 22x1,5-wd-OMD	18,07
L	400	18	M 18 x 1,5					GE-L-18-M 18x1,5-wd-OMD	15,25
L	400	18	M 22 x 1,5					GE-L-18-M 22x1,5-wd-OMD	14,08
L	250	18	M 26 x 1,5					GE-L-18-M 26x1,5-wd-OMD	*
L	250	22	M 22 x 1,5					GE-L-22-M 22x1,5-wd-OMD	25,19
L	250	22	M 26 x 1,5					GE-L-22-M 26x1,5-wd-OMD	20,62
L	250	28	M 33 x 2					GE-L-28-M 33x2-wd-OMD	30,53
L	250	35	M 42 x 2					GE-L-35-M 42x2-wd-OMD	33,34
L	250	42	M 48 x 2					GE-L-42-M 48x2-wd-OMD	49,26

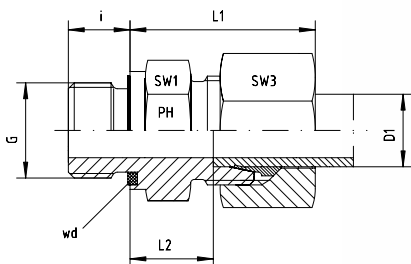

Gerade Einschraubverschraubungen

S-Reihe

Einschraubgewinde: Metrisches Feingewinde - Zylindrisch
wd = Abdichtung durch Profildichtung - Viton

Male Stud Couplings

S-Series

Thread: Metric - Parallel

wd = Sealing by an Elastomer Profiled Ring - Viton

Reihe Series	Druck Pressure PN	Rohr A.D. Tube O.D. D1	Gewinde Thread G	Ca. Maße Approx. Dimensions					Bestellzeichen Order-Code Standard	Brutto-Preis Gross-Price Euro (€)
				L1	L2	i	SW1	SW3		
S	800	6	M 12 x 1,5	28,0	13,0	12	17	17	GE-S-06-M 12x1,5-wd	11,73
S	800	6	M 14 x 1,5	30,0	13,0	12	19	17	GE-S-06-M 14x1,5-wd	15,34
S	800	8	M 12 x 1,5	32,0	15,0	12	17	19	GE-S-08-M 12x1,5-wd	16,50
S	800	8	M 14 x 1,5	30,0	15,0	12	19	19	GE-S-08-M 14x1,5-wd	13,27
S	800	8	M 16 x 1,5	33,0	15,5	12	22	19	GE-S-08-M 16x1,5-wd	15,95
S	800	10	M 14 x 1,5	32,0	14,5	12	19	22	GE-S-10-M 14x1,5-wd	17,90
S	800	10	M 16 x 1,5	31,0	15,0	12	22	22	GE-S-10-M 16x1,5-wd	14,39
S	630	10	M 18 x 1,5	31,0	15,0	12	24	22	GE-S-10-M 18x1,5-wd	18,50
S	630	12	M 14 x 1,5	33,0	16,0	12	22	24	GE-S-12-M 14x1,5-wd	16,95
S	630	12	M 16 x 1,5	35,5	17,0	12	22	24	GE-S-12-M 16x1,5-wd	17,40
S	630	12	M 18 x 1,5	33,0	17,0	12	24	24	GE-S-12-M 18x1,5-wd	15,16
S	630	12	M 20 x 1,5	36,0	17,5	14	27	24	GE-S-12-M 20x1,5-wd	23,45
S	630	12	M 22 x 1,5	36,5	17,5	14	27	24	GE-S-12-M 22x1,5-wd	18,00
S	630	14	M 20 x 1,5	39,0	19,0	14	27	27	GE-S-14-M 20x1,5-wd	18,74
S	630	14	M 22 x 1,5	39,0	18,5	14	27	27	GE-S-14-M 22x1,5-wd	28,90
S	630	16	M 18 x 1,5		18,0	12	27	30	GE-S-16-M 18x1,5-wd	25,10
S	630	16	M 22 x 1,5	37,0	18,5	14	27	30	GE-S-16-M 22x1,5-wd	23,01
S	420	20	M 27 x 2	42,5	20,5	16	32	36	GE-S-20-M 27x2-wd	32,57
S	420	25	M 33 x 2	47,0	23,0	18	41	46	GE-S-25-M 33x2-wd	51,64
S	420	30	M 42 x 2	50,0	23,5	20	50	50	GE-S-30-M 42x2-wd	61,61
S	420	38	M 48 x 2	57,0	26,0	22	55	60	GE-S-38-M 48x2-wd	77,64

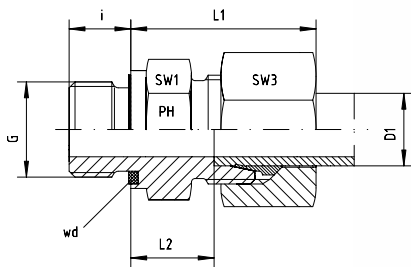

Gerade Einschraubverschraubungen

S-Reihe

Einschraubgewinde: Metrisches Feingewinde - Zylindrisch
wd = Abdichtung durch Profildichtung - Viton

Male Stud Couplings

S-Series

Thread: Metric - Parallel

wd = Sealing by an Elastomer Profiled Ring - Viton

Reihe Series	Druck Pressure PN	Rohr A.D. Tube O.D. D1	Gewinde Thread G	Ca. Maße Approx. Dimensions					Bestellzeichen Order-Code SC	Brutto-Preis Gross-Price Euro (€)
				L1	L2	i	SW1	SW3		
S	800	6	M 12 x 1,5	28,0	13,0	12	17	17	GE-S-06-M 12x1,5-wd-SC	12,17
S	800	6	M 14 x 1,5	30,0	13,0	12	19	17	GE-S-06-M 14x1,5-wd-SC	15,78
S	800	8	M 12 x 1,5	32,0	15,0	12	17	19	GE-S-08-M 12x1,5-wd-SC	*
S	800	8	M 14 x 1,5	30,0	15,0	12	19	19	GE-S-08-M 14x1,5-wd-SC	13,71
S	800	8	M 16 x 1,5	33,0	15,5	12	22	19	GE-S-08-M 16x1,5-wd-SC	16,54
S	800	10	M 14 x 1,5	32,0	14,5	12	19	22	GE-S-10-M 14x1,5-wd-SC	18,46
S	800	10	M 16 x 1,5	31,0	15,0	12	22	22	GE-S-10-M 16x1,5-wd-SC	14,95
S	630	10	M 18 x 1,5	32,0	15,0	12	24	22	GE-S-10-M 18x1,5-wd-SC	19,06
S	630	12	M 14 x 1,5	33,0	16,0	12	22	24	GE-S-12-M 14x1,5-wd-SC	17,79
S	630	12	M 16 x 1,5	35,5	17,0	12	22	24	GE-S-12-M 16x1,5-wd-SC	18,24
S	630	12	M 18 x 1,5	33,0	17,0	12	24	24	GE-S-12-M 18x1,5-wd-SC	16,00
S	630	12	M 20 x 1,5	36,0	17,5	14	27	24	GE-S-12-M 20x1,5-wd-SC	24,50
S	630	12	M 22 x 1,5	36,5	17,5	14	27	24	GE-S-12-M 22x1,5-wd-SC	18,84
S	630	14	M 20 x 1,5	39,0	19,0	14	27	27	GE-S-14-M 20x1,5-wd-SC	20,30
S	630	14	M 22 x 1,5	39,0	18,5	14	27	27	GE-S-14-M 22x1,5-wd-SC	30,46
S	630	16	M 18 x 1,5		18,0	12	27	30	GE-S-16-M 18x1,5-wd-SC	26,66
S	630	16	M 22 x 1,5	37,0	18,5	14	27	30	GE-S-16-M 22x1,5-wd-SC	24,57
S	420	20	M 27 x 2	42,5	20,5	16	32	36	GE-S-20-M 27x2-wd-SC	34,45
S	420	25	M 33 x 2	47,0	23,0	18	41	46	GE-S-25-M 33x2-wd-SC	54,64
S	420	30	M 42 x 2	50,0	23,5	20	50	50	GE-S-30-M 42x2-wd-SC	65,77
S	420	38	M 48 x 2	57,0	26,0	22	55	60	GE-S-38-M 48x2-wd-SC	83,28



Gerade Einschraubverschraubungsstutzen
S-Reihe

Einschraubgewinde: Metrisches Feingewinde - Zylindrisch
wd = Abdichtung durch Profildichtung - Viton

Male Stud Coupling Bodies

S-Series

Thread: Metric - Parallel

wd = Sealing by an Elastomer Profiled Ring - Viton

Reihe Series	Druck Pressure PN	Rohr A.D. Tube O.D. D1	Gewinde Thread G	Ca. Maße Approx. Dimensions					Bestellzeichen Order-Code OMD	Brutto-Preis Gross-Price Euro (€)
S	800	6	M 12 x 1,5						GE-S-06-M 12x1,5-wd-OMD	8,94
S	800	6	M 14 x 1,5						GE-S-06-M 14x1,5-wd-OMD	12,55
S	800	8	M 12 x 1,5						GE-S-08-M 12x1,5-wd-OMD	13,30
S	800	8	M 14 x 1,5						GE-S-08-M 14x1,5-wd-OMD	10,07
S	800	8	M 16 x 1,5						GE-S-08-M 16x1,5-wd-OMD	12,75
S	800	10	M 14 x 1,5						GE-S-10-M 14x1,5-wd-OMD	15,90
S	800	10	M 16 x 1,5						GE-S-10-M 16x1,5-wd-OMD	10,45
S	630	10	M 18 x 1,5						GE-S-10-M 18x1,5-wd-OMD	14,56
S	630	12	M 14 x 1,5						GE-S-12-M 14x1,5-wd-OMD	12,50
S	630	12	M 16 x 1,5						GE-S-12-M 16x1,5-wd-OMD	12,95
S	630	12	M 18 x 1,5						GE-S-12-M 18x1,5-wd-OMD	10,71
S	630	12	M 20 x 1,5						GE-S-12-M 20x1,5-wd-OMD	19,00
S	630	12	M 22 x 1,5						GE-S-12-M 22x1,5-wd-OMD	13,55
S	630	14	M 20 x 1,5						GE-S-14-M 20x1,5-wd-OMD	13,24
S	630	14	M 22 x 1,5						GE-S-14-M 22x1,5-wd-OMD	23,40
S	630	16	M 18 x 1,5						GE-S-16-M 18x1,5-wd-OMD	16,89
S	630	16	M 22 x 1,5						GE-S-16-M 22x1,5-wd-OMD	14,80
S	420	20	M 27 x 2						GE-S-20-M 27x2-wd-OMD	21,99
S	420	25	M 33 x 2						GE-S-25-M 33x2-wd-OMD	33,02
S	420	30	M 42 x 2						GE-S-30-M 42x2-wd-OMD	38,17
S	420	38	M 48 x 2						GE-S-38-M 48x2-wd-OMD	45,83

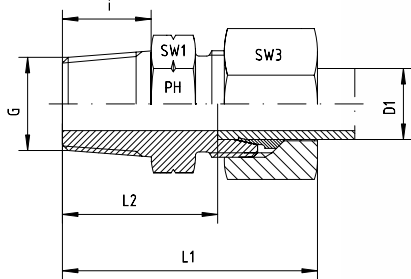

Gerade Einschraubverschraubungen
LL- und L-Reihe
Einschraubgewinde: NPT
Andere Sprunggrößen auf Anfrage!

Male Stud Couplings
LL - and L-Series
Thread: NPT
Other jump sizes on request!

Reihe Series	Druck Pressure PN	Rohr A.D. Tube O.D. D1	Gewinde Thread G	Ca. Maße Approx. Dimensions					Bestellzeichen Order-Code Standard	Brutto-Preis Gross-Price Euro (€)
				L1	L2	i	SW1	SW3		
LL	100	4	1/8" NPT	28	18,5	10,0	11	10	GE-LL-04-1/8"-NPT	10,87
LL	100	6	1/8" NPT	28	16,5	10,0	11	12	GE-LL-06-1/8"-NPT	12,02
LL	100	8	1/8" NPT	30	18,5	10,0	12	14	GE-LL-08-1/8"-NPT	13,50

Reihe Series	Druck Pressure PN	Rohr A.D. Tube O.D. D1	Gewinde Thread G	Ca. Maße Approx. Dimensions					Bestellzeichen Order-Code Standard	Brutto-Preis Gross-Price Euro (€)
				L1	L2	i	SW1	SW3		
L	315	6	1/8" NPT	32	17,0	10,0	12	14	GE-L-06-1/8"-NPT	10,12
L	315	6	1/4" NPT	38	23,0	15,0	17	14	GE-L-06-1/4"-NPT	10,40
L	315	6	3/8" NPT	38	23,0	15,3	19	14	GE-L-06-3/8"-NPT	13,29
L	315	6	1/2" NPT	44	29,0	20,0	22	14	GE-L-06-1/2"-NPT	16,75
L	315	8	1/8" NPT	33	18,0	10,0	14	17	GE-L-08-1/8"-NPT	10,30
L	315	8	1/4" NPT	38	23,0	15,0	17	17	GE-L-08-1/4"-NPT	11,25
L	315	8	3/8" NPT	38	23,0	15,3	19	17	GE-L-08-3/8"-NPT	13,98
L	315	8	1/2" NPT	44	29,0	20,0	24	17	GE-L-08-1/2"-NPT	17,46
L	315	10	1/8" NPT	33	18,0	10,0	17	19	GE-L-10-1/8"-NPT	13,19
L	315	10	1/4" NPT	39	24,0	15,0	17	19	GE-L-10-1/4"-NPT	13,34
L	315	10	3/8" NPT	40	25,0	15,3	19	19	GE-L-10-3/8"-NPT	15,42
L	315	10	1/2" NPT	45	30,0	20,0	24	19	GE-L-10-1/2"-NPT	18,56
L	160	10	3/4" NPT	46	31,0	20,0	27	19	GE-L-10-3/4"-NPT	21,60
L	315	12	1/8" NPT	34	19,0	10,0	19	22	GE-L-12-1/8"-NPT	15,08
L	315	12	1/4" NPT	40	25,0	15,0	19	22	GE-L-12-1/4"-NPT	15,72
L	315	12	3/8" NPT	40	25,0	15,3	19	22	GE-L-12-3/8"-NPT	16,49
L	315	12	1/2" NPT	45	30,0	20,0	22	22	GE-L-12-1/2"-NPT	17,28
L	160	12	3/4" NPT	48	31,0	20,0	27	22	GE-L-12-3/4"-NPT	23,11
L	315	15	1/4" NPT	45	26,0	15,0	24	27	GE-L-15-1/4"-NPT	19,58
L	315	15	3/8" NPT	41	26,0	15,3	24	27	GE-L-15-3/8"-NPT	20,32
L	315	15	1/2" NPT	46	31,0	20,0	24	27	GE-L-15-1/2"-NPT	21,50
L	160	15	3/4" NPT	47	32,0	20,0	27	27	GE-L-15-3/4"-NPT	23,52
L	315	18	3/8" NPT	43	26,5	15,3	27	32	GE-L-18-3/8"-NPT	29,71
L	315	18	1/2" NPT	48	31,5	20,0	27	32	GE-L-18-1/2"-NPT	28,12
L	160	18	3/4" NPT	48	31,5	20,0	27	32	GE-L-18-3/4"-NPT	29,66
L	160	18	1" NPT	54	37,5	25,0	36	32	GE-L-18-1"-NPT	40,78
L	160	22	3/8" NPT	45	28,5	15,3	32	36	GE-L-22-3/8"-NPT	38,35
L	160	22	1/2" NPT	50	33,5	20,0	32	36	GE-L-22-1/2"-NPT	33,75
L	160	22	3/4" NPT	50	33,5	20,0	32	36	GE-L-22-3/4"-NPT	35,94
L	160	22	1" NPT	56	39,5	25,0	36	36	GE-L-22-1"-NPT	43,82
L	160	22	1 1/4" NPT	68	46,5	25,5	46	36	GE-L-22-1 1/4"-NPT	60,84
L	160	28	1/2" NPT	56	35,0	20,0	41	41	GE-L-28-1/2"-NPT	55,22
L	160	28	3/4" NPT	51	34,5	20,0	41	41	GE-L-28-3/4"-NPT	54,20
L	160	28	1" NPT	56	39,5	25,0	41	41	GE-L-28-1"-NPT	52,15
L	160	28	1 1/4" NPT	48	41,5	25,5	46	41	GE-L-28-1 1/4"-NPT	61,36
L	160	35	3/4" NPT			20,0	46	50	GE-L-35-3/4"-NPT	73,37
L	160	35	1" NPT	61	39,5	25,0	46	50	GE-L-35-1"-NPT	71,58
L	160	35	1 1/4" NPT	62	40,5	25,5	46	50	GE-L-35-1 1/4"-NPT	68,51
L	160	35	1 1/2" NPT	69	42,5	26,0	55	50	GE-L-35-1 1/2"-NPT	84,36
L	160	42	1" NPT	67	40,5	25,0	55	60	GE-L-42-1"-NPT	85,39
L	160	42	1 1/4" NPT	65	42,0	25,5	55	60	GE-L-42-1 1/4"-NPT	83,85
L	160	42	1 1/2" NPT	65	42,0	26,0	55	60	GE-L-42-1 1/2"-NPT	84,36

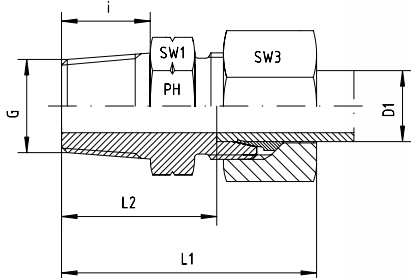

Gerade Einschraubverschraubungen
L-Reihe
Einschraubgewinde: NPT
Andere Sprunggrößen auf Anfrage!

Male Stud Couplings
L-Series
Thread: NPT
Other jump sizes on request!

Reihe Series	Druck Pressure PN	Rohr A.D. Tube O.D. D1	Gewinde Thread G	Ca. Maße Approx. Dimensions					Bestellzeichen Order-Code SC	Brutto-Preis Gross-Price Euro (€)
				L1	L2	i	SW1	SW3		
L	315	6	1/8" NPT	32	17,0	10,0	12	14	GE-L-06-1/8"-NPT-SC	10,44
L	315	6	1/4" NPT	38	23,0	15,0	17	14	GE-L-06-1/4"-NPT-SC	10,72
L	315	6	3/8" NPT	38	23,0	15,3	19	14	GE-L-06-3/8"-NPT-SC	13,61
L	315	6	1/2" NPT	44	29,0	20,0	22	14	GE-L-06-1/2"-NPT-SC	17,07
L	315	8	1/8" NPT	33	18,0	10,0	14	17	GE-L-08-1/8"-NPT-SC	10,74
L	315	8	1/4" NPT	38	23,0	15,0	17	17	GE-L-08-1/4"-NPT-SC	11,69
L	315	8	3/8" NPT	38	23,0	15,3	19	17	GE-L-08-3/8"-NPT-SC	14,42
L	315	8	1/2" NPT	44	29,0	20,0	24	17	GE-L-08-1/2"-NPT-SC	17,90
L	315	10	1/8" NPT	33	18,0	10,0	17	19	GE-L-10-1/8"-NPT-SC	13,63
L	315	10	1/4" NPT	39	24,0	15,0	17	19	GE-L-10-1/4"-NPT-SC	13,78
L	315	10	3/8" NPT	40	25,0	15,3	19	19	GE-L-10-3/8"-NPT-SC	15,86
L	315	10	1/2" NPT	45	30,0	20,0	24	19	GE-L-10-1/2"-NPT-SC	19,00
L	160	10	3/4" NPT	46	31,0	20,0	27	19	GE-L-10-3/4"-NPT-SC	22,04
L	315	12	1/8" NPT	34	19,0	10,0	19	22	GE-L-12-1/8"-NPT-SC	15,64
L	315	12	1/4" NPT	40	25,0	15,0	19	22	GE-L-12-1/4"-NPT-SC	16,28
L	315	12	3/8" NPT	40	25,0	15,3	19	22	GE-L-12-3/8"-NPT-SC	17,05
L	315	12	1/2" NPT	45	30,0	20,0	22	22	GE-L-12-1/2"-NPT-SC	17,84
L	160	12	3/4" NPT	48	31,0	20,0	27	22	GE-L-12-3/4"-NPT-SC	23,67
L	315	15	1/4" NPT	45	26,0	15,0	24	27	GE-L-15-1/4"-NPT-SC	20,66
L	315	15	3/8" NPT	41	26,0	15,3	24	27	GE-L-15-3/8"-NPT-SC	21,40
L	315	15	1/2" NPT	46	31,0	20,0	24	27	GE-L-15-1/2"-NPT-SC	22,58
L	160	15	3/4" NPT	47	32,0	20,0	27	27	GE-L-15-3/4"-NPT-SC	24,60
L	315	18	3/8" NPT	43	26,5	15,3	27	32	GE-L-18-3/8"-NPT-SC	31,35
L	315	18	1/2" NPT	48	31,5	20,0	27	32	GE-L-18-1/2"-NPT-SC	29,76
L	160	18	3/4" NPT	48	31,5	20,0	27	32	GE-L-18-3/4"-NPT-SC	31,30
L	160	18	1" NPT	54	37,5	25,0	36	32	GE-L-18-1"-NPT-SC	42,42
L	160	22	3/8" NPT	45	28,5	15,3	32	36	GE-L-22-3/8"-NPT-SC	40,11
L	160	22	1/2" NPT	50	33,5	20,0	32	36	GE-L-22-1/2"-NPT-SC	35,51
L	160	22	3/4" NPT	50	33,5	20,0	32	36	GE-L-22-3/4"-NPT-SC	37,70
L	160	22	1" NPT	56	39,5	25,0	36	36	GE-L-22-1"-NPT-SC	45,58
L	160	22	1 1/4" NPT	68	46,5	25,5	46	36	GE-L-22-1 1/4"-NPT-SC	62,60
L	160	28	1/2" NPT	56	35,0	20,0	41	41	GE-L-28-1/2"-NPT-SC	57,22
L	160	28	3/4" NPT	51	34,5	20,0	41	41	GE-L-28-3/4"-NPT-SC	56,20
L	160	28	1" NPT	56	39,5	25,0	41	41	GE-L-28-1"-NPT-SC	54,15
L	160	28	1 1/4" NPT	48	41,5	25,5	46	41	GE-L-28-1 1/4"-NPT-SC	63,36
L	160	35	3/4" NPT			20,0	46	50	GE-L-35-3/4"-NPT-SC	77,09
L	160	35	1" NPT	61	39,5	25,0	46	50	GE-L-35-1"-NPT-SC	75,30
L	160	35	1 1/4" NPT	62	40,5	25,5	46	50	GE-L-35-1 1/4"-NPT-SC	72,23
L	160	35	1 1/2" NPT	69	42,5	26,0	55	50	GE-L-35-1 1/2"-NPT-SC	88,08
L	160	42	1" NPT	67	40,5	25,0	55	60	GE-L-42-1"-NPT-SC	89,71
L	160	42	1 1/4" NPT	65	42,0	25,5	55	60	GE-L-42-1 1/4"-NPT-SC	88,17
L	160	42	1 1/2" NPT	65	42,0	26,0	55	60	GE-L-42-1 1/2"-NPT-SC	88,68



Gerade Einschraubverschraubungsstutzen
LL- und L-Reihe
Einschraubgewinde: NPT
Andere Sprunggrößen auf Anfrage!

Male Stud Coupling Bodies
LL - and L-Series
Thread: NPT
Other jump sizes on request!

Reihe Series	Druck Pressure PN	Rohr A.D. Tube O.D. D1	Gewinde Thread G	Ca. Maße Approx. Dimensions				Bestellzeichen Order-Code OMD	Brutto-Preis Gross-Price Euro (€)
LL	100	4	1/8" NPT					GE-LL-04-1/8"-NPT-OMD	8,21
LL	100	6	1/8" NPT					GE-LL-06-1/8"-NPT-OMD	8,98
LL	100	8	1/8" NPT					GE-LL-08-1/8"-NPT-OMD	10,00

Reihe Series	Druck Pressure PN	Rohr A.D. Tube O.D. D1	Gewinde Thread G	Ca. Maße Approx. Dimensions				Bestellzeichen Order-Code OMD	Brutto-Preis Gross-Price Euro (€)
L	315	6	1/8" NPT					GE-L-06-1/8"-NPT-OMD	7,81
L	315	6	1/4" NPT					GE-L-06-1/4"-NPT-OMD	8,09
L	315	6	3/8" NPT					GE-L-06-3/8"-NPT-OMD	10,98
L	315	6	1/2" NPT					GE-L-06-1/2"-NPT-OMD	14,44
L	315	8	1/8" NPT					GE-L-08-1/8"-NPT-OMD	7,50
L	315	8	1/4" NPT					GE-L-08-1/4"-NPT-OMD	8,45
L	315	8	3/8" NPT					GE-L-08-3/8"-NPT-OMD	11,18
L	315	8	1/2" NPT					GE-L-08-1/2"-NPT-OMD	14,66
L	315	10	1/8" NPT					GE-L-10-1/8"-NPT-OMD	9,83
L	315	10	1/4" NPT					GE-L-10-1/4"-NPT-OMD	9,98
L	315	10	3/8" NPT					GE-L-10-3/8"-NPT-OMD	12,06
L	315	10	1/2" NPT					GE-L-10-1/2"-NPT-OMD	15,20
L	160	10	3/4" NPT					GE-L-10-3/4"-NPT-OMD	18,24
L	315	12	1/8" NPT					GE-L-12-1/8"-NPT-OMD	11,19
L	315	12	1/4" NPT					GE-L-12-1/4"-NPT-OMD	11,83
L	315	12	3/8" NPT					GE-L-12-3/8"-NPT-OMD	12,60
L	315	12	1/2" NPT					GE-L-12-1/2"-NPT-OMD	13,39
L	160	12	3/4" NPT					GE-L-12-3/4"-NPT-OMD	19,22
L	315	15	1/4" NPT					GE-L-15-1/4"-NPT-OMD	14,44
L	315	15	3/8" NPT					GE-L-15-3/8"-NPT-OMD	15,18
L	315	15	1/2" NPT					GE-L-15-1/2"-NPT-OMD	16,36
L	160	15	3/4" NPT					GE-L-15-3/4"-NPT-OMD	18,38
L	315	18	3/8" NPT					GE-L-18-3/8"-NPT-OMD	21,09
L	315	18	1/2" NPT					GE-L-18-1/2"-NPT-OMD	19,50
L	160	18	3/4" NPT					GE-L-18-3/4"-NPT-OMD	21,04
L	160	18	1" NPT					GE-L-18-1"-NPT-OMD	32,16
L	160	22	3/8" NPT					GE-L-22-3/8"-NPT-OMD	28,04
L	160	22	1/2" NPT					GE-L-22-1/2"-NPT-OMD	23,44
L	160	22	3/4" NPT					GE-L-22-3/4"-NPT-OMD	25,63
L	160	22	1" NPT					GE-L-22-1"-NPT-OMD	33,51
L	160	22	1 1/4" NPT					GE-L-22-1 1/4"-NPT-OMD	50,53
L	160	28	1/2" NPT					GE-L-28-1/2"-NPT-OMD	40,37
L	160	28	3/4" NPT					GE-L-28-3/4"-NPT-OMD	39,35
L	160	28	1" NPT					GE-L-28-1"-NPT-OMD	37,30
L	160	28	1 1/4" NPT					GE-L-28-1 1/4"-NPT-OMD	46,51
L	160	35	3/4" NPT					GE-L-35-3/4"-NPT-OMD	52,26
L	160	35	1" NPT					GE-L-35-1"-NPT-OMD	50,47
L	160	35	1 1/4" NPT					GE-L-35-1 1/4"-NPT-OMD	47,40
L	160	35	1 1/2" NPT					GE-L-35-1 1/2"-NPT-OMD	63,25
L	160	42	1" NPT					GE-L-42-1"-NPT-OMD	57,96
L	160	42	1 1/4" NPT					GE-L-42-1 1/4"-NPT-OMD	56,42
L	160	42	1 1/2" NPT					GE-L-42-1 1/2"-NPT-OMD	56,93

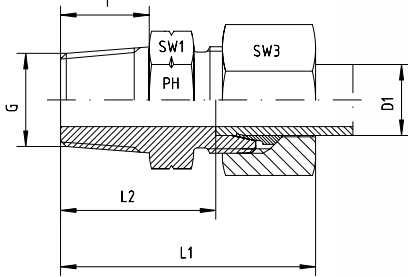

Gerade Einschraubverschraubungen
S-Reihe
Einschraubgewinde: NPT
Andere Sprunggrößen auf Anfrage!

Male Stud Couplings
S-Series
Thread: NPT
Other jump sizes on request!

Reihe Series	Druck Pressure PN	Rohr A.D. Tube O.D. D1	Gewinde Thread G	Ca. Maße Approx. Dimensions					Bestellzeichen Order-Code Standard	Brutto-Preis Gross-Price Euro (€)
				L1	L2	i	SW1	SW3		
S	630	6	1/8" NPT	36,0	21,0	10,0	14	17	GE-S-06-1/8"-NPT	11,20
S	630	6	1/4" NPT	43,0	28,0	15,0	17	17	GE-S-06-1/4"-NPT	11,56
S	630	6	3/8" NPT	41,0	26,0	15,3	19	17	GE-S-06-3/8"-NPT	16,87
S	630	6	1/2" NPT	50,0	35,0	20,0	22	17	GE-S-06-1/2"-NPT	16,62
S	630	8	1/8" NPT		23,0	10,0	17	19	GE-S-08-1/8"-NPT	14,27
S	630	8	1/4" NPT	43,0	28,0	15,0	17	19	GE-S-08-1/4"-NPT	13,50
S	630	8	3/8" NPT	43,0	28,0	15,3	19	19	GE-S-08-3/8"-NPT	14,60
S	630	8	1/2" NPT	50,0	35,0	20,0	22	19	GE-S-08-1/2"-NPT	17,49
S	630	10	1/8" NPT	40,0	22,5	10,0	19	22	GE-S-10-1/8"-NPT	16,31
S	630	10	1/4" NPT	44,0	27,5	15,0	19	22	GE-S-10-1/4"-NPT	15,64
S	630	10	3/8" NPT	44,0	27,5	15,3	19	22	GE-S-10-3/8"-NPT	16,11
S	630	10	1/2" NPT	51,0	34,5	20,0	22	22	GE-S-10-1/2"-NPT	18,28
S	400	10	3/4" NPT	50,5	31,5	20,0	27	22	GE-S-10-3/4"-NPT	21,07
S	630	12	1/4" NPT	46,0	29,5	15,0	22	24	GE-S-12-1/4"-NPT	17,44
S	630	12	3/8" NPT	46,0	29,5	15,3	22	24	GE-S-12-3/8"-NPT	18,38
S	630	12	1/2" NPT	51,0	34,5	20,0	22	24	GE-S-12-1/2"-NPT	17,64
S	400	12	3/4" NPT	53,0	36,5	20,0	27	24	GE-S-12-3/4"-NPT	21,73
S	630	14	3/8" NPT	49,0	23,0	15,3	24	27	GE-S-14-3/8"-NPT	19,94
S	630	14	1/2" NPT	54,0	36,0	20,0	24	27	GE-S-14-1/2"-NPT	21,53
S	400	14	3/4" NPT	56,0	38,0	20,0	27	27	GE-S-14-3/4"-NPT	23,72
S	400	16	3/8" NPT	49,0	30,5	15,3	27	30	GE-S-16-3/8"-NPT	27,81
S	400	16	1/2" NPT	54,0	35,5	20,0	27	30	GE-S-16-1/2"-NPT	29,40
S	400	16	3/4" NPT	56,0	37,5	20,0	30	30	GE-S-16-3/4"-NPT	29,91
S	400	16	1" NPT	63,0	44,5	25,0	36	30	GE-S-16-1"-NPT	33,62
S	400	20	3/8" NPT		32,5	15,3	32	36	GE-S-20-3/8"-NPT	37,84
S	400	20	1/2" NPT	59,0	37,5	20,0	32	36	GE-S-20-1/2"-NPT	36,81
S	400	20	3/4" NPT	59,0	37,5	20,0	32	36	GE-S-20-3/4"-NPT	37,07
S	400	20	1" NPT	66,0	44,5	25,0	36	36	GE-S-20-1"-NPT	45,74
S	400	20	1 1/4" NPT	67,5	44,5	25,5	46	36	GE-S-20-1 1/4"-NPT	63,40
S	400	25	1/2" NPT	67,5	40,0	20,0	41	46	GE-S-25-1/2"-NPT	61,36
S	400	25	3/4" NPT	64,0	40,0	20,0	41	46	GE-S-25-3/4"-NPT	58,29
S	400	25	1" NPT	69,0	45,0	25,0	41	46	GE-S-25-1"-NPT	58,29
S	400	25	1 1/4" NPT	70,0	46,0	25,5	46	46	GE-S-25-1 1/4"-NPT	63,91
S	400	30	3/4" NPT	67,0	40,5	20,0	46	50	GE-S-30-3/4"-NPT	79,25
S	400	30	1" NPT	72,0	45,5	25,0	46	50	GE-S-30-1"-NPT	82,83
S	400	30	1 1/4" NPT	73,0	46,5	25,5	46	50	GE-S-30-1 1/4"-NPT	79,25
S	315	30	1 1/2" NPT	73,0	46,5	26,0	55	50	GE-S-30-1 1/2"-NPT	89,48
S	315	38	1" NPT	79,0	48,0	25,0	55	60	GE-S-38-1"-NPT	115,04
S	315	38	1 1/4" NPT	80,0	49,0	25,5	55	60	GE-S-38-1 1/4"-NPT	115,04
S	315	38	1 1/2" NPT	80,0	49,0	26,0	55	60	GE-S-38-1 1/2"-NPT	112,49

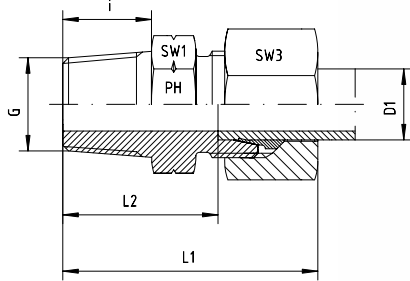

Gerade Einschraubverschraubungen
S-Reihe
Einschraubgewinde: NPT
Andere Sprunggrößen auf Anfrage!

Male Stud Couplings
S-Series
Thread: NPT
Other jump sizes on request!

Reihe Series	Druck Pressure PN	Rohr A.D. Tube O.D. D1	Gewinde Thread G	Ca. Maße Approx. Dimensions					Bestellzeichen Order-Code SC	Brutto-Preis Gross-Price Euro (€)
				L1	L2	i	SW1	SW3		
S	630	6	1/8" NPT	36,0	21,0	10,0	14	17	GE-S-06-1/8"-NPT-SC	11,64
S	630	6	1/4" NPT	43,0	28,0	15,0	17	17	GE-S-06-1/4"-NPT-SC	12,00
S	630	6	3/8" NPT	41,0	26,0	15,3	19	17	GE-S-06-3/8"-NPT-SC	17,31
S	630	6	1/2" NPT	50,0	35,0	20,0	22	17	GE-S-06-1/2"-NPT-SC	17,06
S	630	8	1/8" NPT		23,0	10,0	17	19	GE-S-08-1/8"-NPT-SC	14,71
S	630	8	1/4" NPT	43,0	28,0	15,0	17	19	GE-S-08-1/4"-NPT-SC	13,94
S	630	8	3/8" NPT	43,0	28,0	15,3	19	19	GE-S-08-3/8"-NPT-SC	15,04
S	630	8	1/2" NPT	50,0	35,0	20,0	22	19	GE-S-08-1/2"-NPT-SC	17,93
S	630	10	1/8" NPT		22,5	10,0	19	22	GE-S-10-1/8"-NPT-SC	16,87
S	630	10	1/4" NPT	44,0	27,5	15,0	19	22	GE-S-10-1/4"-NPT-SC	16,20
S	630	10	3/8" NPT	44,0	27,5	15,3	19	22	GE-S-10-3/8"-NPT-SC	16,67
S	630	10	1/2" NPT	51,0	34,5	20,0	22	22	GE-S-10-1/2"-NPT-SC	18,84
S	400	10	3/4" NPT	50,5	31,5	20,0	27	22	GE-S-10-3/4"-NPT-SC	21,63
S	630	12	1/4" NPT	46,0	29,5	15,0	22	24	GE-S-12-1/4"-NPT-SC	18,28
S	630	12	3/8" NPT	46,0	29,5	15,3	22	24	GE-S-12-3/8"-NPT-SC	19,22
S	630	12	1/2" NPT	51,0	34,5	20,0	22	24	GE-S-12-1/2"-NPT-SC	18,48
S	400	12	3/4" NPT	53,0	36,5	20,0	27	24	GE-S-12-3/4"-NPT-SC	22,57
S	630	14	3/8" NPT	49,0	23,0	15,3	24	27	GE-S-14-3/8"-NPT-SC	21,50
S	630	14	1/2" NPT	54,0	36,0	20,0	24	27	GE-S-14-1/2"-NPT-SC	23,09
S	400	14	3/4" NPT	56,0	38,0	20,0	27	27	GE-S-14-3/4"-NPT-SC	25,28
S	400	16	3/8" NPT	49,0	30,5	15,3	27	30	GE-S-16-3/8"-NPT-SC	29,37
S	400	16	1/2" NPT	54,0	35,5	20,0	27	30	GE-S-16-1/2"-NPT-SC	30,96
S	400	16	3/4" NPT	56,0	37,5	20,0	30	30	GE-S-16-3/4"-NPT-SC	31,47
S	400	16	1" NPT	63,0	44,5	25,0	36	30	GE-S-16-1"-NPT-SC	35,18
S	400	20	3/8" NPT		32,5	15,3	32	36	GE-S-20-3/8"-NPT-SC	39,72
S	400	20	1/2" NPT	59,0	37,5	20,0	32	36	GE-S-20-1/2"-NPT-SC	38,69
S	400	20	3/4" NPT	59,0	37,5	20,0	32	36	GE-S-20-3/4"-NPT-SC	38,95
S	400	20	1" NPT	66,0	44,5	25,0	36	36	GE-S-20-1"-NPT-SC	47,62
S	400	20	1 1/4" NPT	67,5	44,5	25,5	46	36	GE-S-20-1 1/4"-NPT-SC	65,28
S	400	25	1/2" NPT	67,5	40,0	20,0	41	46	GE-S-25-1/2"-NPT-SC	64,36
S	400	25	3/4" NPT	64,0	40,0	20,0	41	46	GE-S-25-3/4"-NPT-SC	61,29
S	400	25	1" NPT	69,0	45,0	25,0	41	46	GE-S-25-1"-NPT-SC	61,29
S	400	25	1 1/4"-NPT	70,0	46,0	25,5	46	46	GE-S-25-1 1/4"-NPT-SC	66,91
S	400	30	3/4"-NPT	67,0	40,5	20,0	46	50	GE-S-30-3/4"-NPT-SC	83,41
S	400	30	1" -NPT	72,0	45,5	25,0	46	50	GE-S-30-1"-NPT-SC	86,99
S	400	30	1 1/4"-NPT	73,0	46,5	25,5	46	50	GE-S-30-1 1/4"-NPT-SC	83,41
S	315	30	1 1/2"-NPT	73,0	46,5	26,0	55	50	GE-S-30-1 1/2"-NPT-SC	93,64
S	315	38	1" -NPT	79,0	48,0	25,0	55	60	GE-S-38-1"-NPT-SC	120,68
S	315	38	1 1/4"-NPT	80,0	49,0	25,5	55	60	GE-S-38-1 1/4"-NPT-SC	120,68
S	315	38	1 1/2" NPT	80,0	49,0	26,0	55	60	GE-S-38-1 1/2"-NPT-SC	118,13



Gerade Einschraubverschraubungsstutzen
S-Reihe
Einschraubgewinde: NPT
Andere Sprunggrößen auf Anfrage!

Male Stud Coupling Bodies
S-Series
Thread: NPT
Other jump sizes on request!

Reihe Series	Druck Pressure PN	Rohr A.D. Tube O.D. D1	Gewinde Thread G	Ca. Maße Approx. Dimensions					Bestellzeichen Order-Code OMD	Brutto-Preis Gross-Price Euro (€)
S	630	6	1/8" NPT						GE-S-06-1/8"-NPT-OMD	8,41
S	630	6	1/4" NPT						GE-S-06-1/4"-NPT-OMD	8,77
S	630	6	3/8" NPT						GE-S-06-3/8"-NPT-OMD	14,08
S	630	6	1/2" NPT						GE-S-06-1/2"-NPT-OMD	13,83
S	630	8	1/8" NPT						GE-S-08-1/8"-NPT-OMD	11,07
S	630	8	1/4" NPT						GE-S-08-1/4"-NPT-OMD	10,30
S	630	8	3/8" NPT						GE-S-08-3/8"-NPT-OMD	11,40
S	630	8	1/2" NPT						GE-S-08-1/2"-NPT-OMD	14,29
S	630	10	1/8" NPT						GE-S-10-1/8"-NPT-OMD	12,37
S	630	10	1/4" NPT						GE-S-10-1/4"-NPT-OMD	11,70
S	630	10	3/8" NPT						GE-S-10-3/8"-NPT-OMD	12,17
S	630	10	1/2" NPT						GE-S-10-1/2"-NPT-OMD	14,34
S	400	10	3/4" NPT						GE-S-10-3/4"-NPT-OMD	17,13
S	630	12	1/4" NPT						GE-S-12-1/4"-NPT-OMD	12,99
S	630	12	3/8" NPT						GE-S-12-3/8"-NPT-OMD	13,93
S	630	12	1/2" NPT						GE-S-12-1/2"-NPT-OMD	13,19
S	400	12	3/4" NPT						GE-S-12-3/4"-NPT-OMD	17,28
S	630	14	3/8" NPT						GE-S-14-3/8"-NPT-OMD	14,44
S	630	14	1/2" NPT						GE-S-14-1/2"-NPT-OMD	16,03
S	400	14	3/4" NPT						GE-S-14-3/4"-NPT-OMD	18,22
S	400	16	3/8" NPT						GE-S-16-3/8"-NPT-OMD	19,60
S	400	16	1/2" NPT						GE-S-16-1/2"-NPT-OMD	21,19
S	400	16	3/4" NPT						GE-S-16-3/4"-NPT-OMD	21,70
S	400	16	1" NPT						GE-S-16-1"-NPT-OMD	25,41
S	400	20	3/8" NPT						GE-S-20-3/8"-NPT-OMD	27,26
S	400	20	1/2" NPT						GE-S-20-1/2"-NPT-OMD	26,23
S	400	20	3/4" NPT						GE-S-20-3/4"-NPT-OMD	26,49
S	400	20	1" NPT						GE-S-20-1"-NPT-OMD	35,16
S	400	20	1 1/4" NPT						GE-S-20-1 1/4"-NPT-OMD	52,82
S	400	25	1/2" NPT						GE-S-25-1/2"-NPT-OMD	42,74
S	400	25	3/4" NPT						GE-S-25-3/4"-NPT-OMD	39,67
S	400	25	1" NPT						GE-S-25-1"-NPT-OMD	39,67
S	400	25	1 1/4" NPT						GE-S-25-1 1/4"-NPT-OMD	45,29
S	400	30	3/4" NPT						GE-S-30-3/4"-NPT-OMD	55,81
S	400	30	1" NPT						GE-S-30-1"-NPT-OMD	59,39
S	400	30	1 1/4" NPT						GE-S-30-1 1/4"-NPT-OMD	55,81
S	315	30	1 1/2" NPT						GE-S-30-1 1/2"-NPT-OMD	66,04
S	315	38	1" NPT						GE-S-38-1"-NPT-OMD	83,23
S	315	38	1 1/4" NPT						GE-S-38-1 1/4"-NPT-OMD	83,23
S	315	38	1 1/2" NPT						GE-S-38-1 1/2"-NPT-OMD	80,68

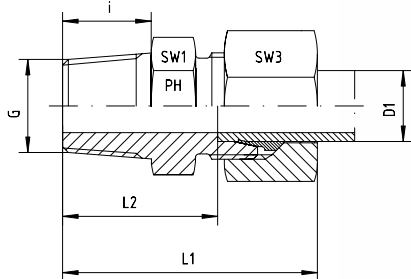

Gerade Einschraubverschraubungen

LL- und L-Reihe

Einschraubgewinde: Whitworth-Rohrgewinde - Kegelig
Andere Sprunggrößen auf Anfrage!

Male Stud Couplings

LL- and L-Series

Thread: BSP - Taper

Other jump sizes on request!

Reihe Series	Druck Pressure PN	Rohr A.D. Tube O.D. D1	Gewinde Thread G	Ca. Maße Approx. Dimensions					Bestellzeichen Order-Code Standard	Brutto-Preis Gross-Price Euro (€)
				L1	L2	i	SW1	SW3		
LL	100	4	R 1/8" keg	26	16,0	8	11	10	GE-LL-04-R 1/8"-k	8,16
LL	100	6	R 1/8" keg	26	14,5	8	11	12	GE-LL-06-R 1/8"-k	9,00
LL	100	6	R 1/4" keg	31	18,5	12	14	12	GE-LL-06-R 1/4"-k	9,71
LL	100	8	R 1/8" keg	28	16,5	8	12	14	GE-LL-08-R 1/8"-k	9,71
LL	100	8	R 1/4" keg	32	20,5	12	14	12	GE-LL-08-R 1/4"-k	10,74

Reihe Series	Druck Pressure PN	Rohr A.D. Tube O.D. D1	Gewinde Thread G	Ca. Maße Approx. Dimensions					Bestellzeichen Order-Code Standard	Brutto-Preis Gross-Price Euro (€)
				L1	L2	i	SW1	SW3		
L	315	6	R 1/8" keg	30	15,0	8	14	14	GE-L-06-R 1/8"-k	10,43
L	315	6	R 1/4" keg	35	20,0	12	17	14	GE-L-06-R 1/4"-k	10,15
L	315	6	R 3/8" keg	36	21,0	12	17	14	GE-L-06-R 3/8"-k	11,76
L	315	6	R 1/2" keg	40	23,0	14	22	14	GE-L-06-R 1/2"-k	15,31
L	315	8	R 1/8" keg	31	16,0	8	14	17	GE-L-08-R 1/8"-k	11,15
L	315	8	R 1/4" keg	35	20,0	12	17	17	GE-L-08-R 1/4"-k	10,40
L	315	8	R 3/8" keg	35	20,0	12	17	17	GE-L-08-R 3/8"-k	12,09
L	315	8	R 1/2" keg	38	22,0	14	22	17	GE-L-08-R 1/2"-k	16,05
L	315	10	R 1/8" keg	32	17,0	8	17	19	GE-L-10-R 1/8"-k	12,73
L	315	10	R 1/4" keg	36	21,0	12	17	19	GE-L-10-R 1/4"-k	12,07
L	315	10	R 3/8" keg	36	21,0	12	17	19	GE-L-10-R 3/8"-k	12,58
L	315	10	R 1/2" keg	39	24,0	14	22	19	GE-L-10-R 1/2"-k	17,44
L	315	12	R 1/8" keg			8	19	22	GE-L-12-R 1/8"-k	15,75
L	315	12	R 1/4" keg	37	22,0	12	19	22	GE-L-12-R 1/4"-k	14,70
L	315	12	R 3/8" keg	37	22,0	12	19	22	GE-L-12-R 3/8"-k	14,70
L	315	12	R 1/2" keg	39	24,0	14	22	22	GE-L-12-R 1/2"-k	16,62
L	160	12	R 3/4" keg	43	27,0	16	27	22	GE-L-12-R 3/4"-k	25,65
L	315	15	R 1/4" keg			12	24	27	GE-L-15-R 1/4"-k	19,90
L	315	15	R 3/8" keg	38	23,0	12	24	27	GE-L-15-R 3/8"-k	18,87
L	315	15	R 1/2" keg	40	25,0	14	24	27	GE-L-15-R 1/2"-k	18,82
L	160	15	R 3/4" keg	45	28,0	16	27	27	GE-L-15-R 3/4"-k	26,50
L	315	18	R 3/8" keg	42	23,5	12	27	32	GE-L-18-R 3/8"-k	24,54
L	315	18	R 1/2" keg	42	25,5	14	27	32	GE-L-18-R 1/2"-k	24,54
L	160	18	R 3/4" keg	47	27,5	16	27	32	GE-L-18-R 3/4"-k	31,90
L	160	22	R 3/8" keg	46	25,5	12	32	36	GE-L-22-R 3/8"-k	34,72
L	160	22	R 1/2" keg	46	25,5	14	32	36	GE-L-22-R 1/2"-k	32,98
L	160	22	R 3/4" keg	46	29,5	16	32	36	GE-L-22-R 3/4"-k	32,98
L	160	22	R 1" keg	50	31,5	18	36	36	GE-L-22-R 1"-k	53,43
L	160	28	R 1/2" keg			14	41	41	GE-L-28-R 1/2"-k	53,94
L	160	28	R 3/4" keg	49	30,5	16	41	41	GE-L-28-R 3/4"-k	53,94
L	160	28	R 1" keg	49	32,5	18	41	41	GE-L-28-R 1"-k	53,94
L	160	28	R 1 1/4" keg	49	30,5	20	46	41	GE-L-28-R 1 1/4"-k	72,60
L	160	35	R 1" keg	51	27,5	18	46	50	GE-L-35-R 1"-k	73,63
L	160	35	R 1 1/4" keg	56	34,5	20	46	50	GE-L-35-R 1 1/4"-k	73,63
L	160	35	R 1 1/2" keg	63	37,5	22	50	50	GE-L-35-R 1 1/2"-k	84,36
L	160	42	R 1 1/4" keg	55	31,0	20	55	60	GE-L-42-R 1 1/4"-k	91,52
L	160	42	R 1 1/2" keg	61	38,0	22	55	60	GE-L-42-R 1 1/2"-k	89,48

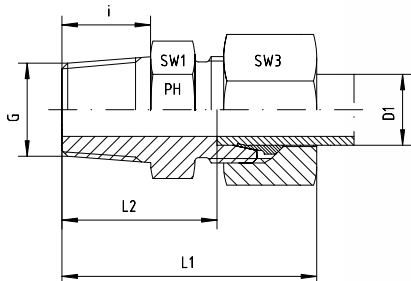

Gerade Einschraubverschraubungen

L-Reihe

Einschraubgewinde: Whitworth-Rohrgewinde - Kegelig
Andere Sprunggrößen auf Anfrage!

Male Stud Couplings

L-Series

Thread: BSP - Taper

Other jump sizes on request!

Reihe Series	Druck Pressure PN	Rohr A.D. Tube O.D. D1	Gewinde Thread G	Ca. Maße Approx. Dimensions					Bestellzeichen Order-Code SC	Brutto-Preis Gross-Price Euro (€)
				L1	L2	i	SW1	SW3		
L	315	6	R 1/8" keg	30	15,0	8	14	14	GE-L-06-R 1/8"-k-SC	10,75
L	315	6	R 1/4" keg	35	20,0	12	17	14	GE-L-06-R 1/4"-k-SC	10,47
L	315	6	R 3/8" keg	36	21,0	12	17	14	GE-L-06-R 3/8"-k-SC	12,08
L	315	6	R 1/2" keg	40	23,0	14	22	14	GE-L-06-R 1/2"-k-SC	15,63
L	315	8	R 1/8" keg	31	16,0	8	14	17	GE-L-08-R 1/8"-k-SC	11,59
L	315	8	R 1/4" keg	35	20,0	12	17	17	GE-L-08-R 1/4"-k-SC	10,84
L	315	8	R 3/8" keg	35	20,0	12	17	17	GE-L-08-R 3/8"-k-SC	12,53
L	315	8	R 1/2" keg	38	22,0	14	22	17	GE-L-08-R 1/2"-k-SC	16,49
L	315	10	R 1/8" keg	32	17,0	8	17	19	GE-L-10-R 1/8"-k-SC	13,17
L	315	10	R 1/4" keg	36	21,0	12	17	19	GE-L-10-R 1/4"-k-SC	12,51
L	315	10	R 3/8" keg	36	21,0	12	17	19	GE-L-10-R 3/8"-k-SC	13,02
L	315	10	R 1/2" keg	39	24,0	14	22	19	GE-L-10-R 1/2"-k-SC	17,88
L	315	12	R 1/8" keg			8	19	22	GE-L-12-R 1/8"-k-SC	16,31
L	315	12	R 1/4" keg	37	22,0	12	19	22	GE-L-12-R 1/4"-k-SC	15,26
L	315	12	R 3/8" keg	37	22,0	12	19	22	GE-L-12-R 3/8"-k-SC	15,26
L	315	12	R 1/2" keg	39	24,0	14	22	22	GE-L-12-R 1/2"-k-SC	17,18
L	160	12	R 3/4" keg	43	27,0	16	27	22	GE-L-12-R 3/4"-k-SC	26,21
L	315	15	R 1/4" keg			12	24	27	GE-L-15-R 1/4"-k-SC	20,98
L	315	15	R 3/8" keg	38	23,0	12	24	27	GE-L-15-R 3/8"-k-SC	19,95
L	315	15	R 1/2" keg	40	25,0	14	24	27	GE-L-15-R 1/2"-k-SC	19,90
L	160	15	R 3/4" keg	45	28,0	16	27	27	GE-L-15-R 3/4"-k-SC	27,58
L	315	18	R 3/8" keg	42	23,5	12	27	32	GE-L-18-R 3/8"-k-SC	26,18
L	315	18	R 1/2" keg	42	25,5	14	27	32	GE-L-18-R 1/2"-k-SC	26,18
L	160	18	R 3/4" keg	47	27,5	16	27	32	GE-L-18-R 3/4"-k-SC	33,54
L	160	22	R 3/8" keg	46	25,5	12	32	36	GE-L-22-R 3/8"-k-SC	36,48
L	160	22	R 1/2" keg	46	25,5	14	32	36	GE-L-22-R 1/2"-k-SC	34,74
L	160	22	R 3/4" keg	46	29,5	16	32	36	GE-L-22-R 3/4"-k-SC	34,74
L	160	22	R 1" keg	50	31,5	18	36	36	GE-L-22-R 1"-k-SC	55,19
L	160	28	R 1/2" keg			14	41	41	GE-L-28-R 1/2"-k-SC	55,94
L	160	28	R 3/4" keg	49	30,5	16	41	41	GE-L-28-R 3/4"-k-SC	55,94
L	160	28	R 1" keg	49	32,5	18	41	41	GE-L-28-R 1"-k-SC	55,94
L	160	28	R 1 1/4" keg	49	30,5	20	46	41	GE-L-28-R 1 1/4"-k-SC	74,60
L	160	35	R 1" keg	51	27,5	18	46	50	GE-L-35-R 1"-k-SC	77,35
L	160	35	R 1 1/4" keg	56	34,5	20	46	50	GE-L-35-R 1 1/4"-k-SC	77,35
L	160	35	R 1 1/2" keg	63	37,5	22	50	50	GE-L-35-R 1 1/2"-k-SC	88,08
L	160	42	R 1 1/4" keg	55	31,0	20	55	60	GE-L-42-R 1 1/4"-k-SC	95,84
L	160	42	R 1 1/2" keg	61	38,0	22	55	60	GE-L-42-R 1 1/2"-k-SC	93,80



Gerade Einschraubverschraubungsstutzen

LL- und L-Reihe

Einschraubgewinde: Whitworth-Rohrgewinde - Kegelig

Andere Sprunggrößen auf Anfrage!

Male Stud Coupling Bodies

LL- and L-Series

Thread: BSP - Taper

Other jump sizes on request!

Reihe Series	Druck Pressure PN	Rohr A.D. Tube O.D. D1	Gewinde Thread G	Ca. Maße Approx. Dimensions					Bestellzeichen Order-Code OMD	Brutto-Preis Gross-Price Euro (€)
LL	100	4	R 1/8" keg						GE-LL-04-R 1/8"-k-OMD	5,50
LL	100	6	R 1/8" keg						GE-LL-06-R 1/8"-k-OMD	5,96
LL	100	6	R 1/4" keg						GE-LL-06-R 1/4"-k-OMD	6,67
LL	100	8	R 1/8" keg						GE-LL-08-R 1/8"-k-OMD	6,21
LL	100	8	R 1/4" keg						GE-LL-08-R 1/4"-k-OMD	7,24

Reihe Series	Druck Pressure PN	Rohr A.D. Tube O.D. D1	Gewinde Thread G	Ca. Maße Approx. Dimensions					Bestellzeichen Order-Code OMD	Brutto-Preis Gross-Price Euro (€)
L	315	6	R 1/8" keg						GE-L-06-R 1/8"-k-OMD	8,12
L	315	6	R 1/4" keg						GE-L-06-R 1/4"-k-OMD	7,84
L	315	6	R 3/8" keg						GE-L-06-R 3/8"-k-OMD	9,45
L	315	6	R 1/2" keg						GE-L-06-R 1/2"-k-OMD	13,00
L	315	8	R 1/8" keg						GE-L-08-R 1/8"-k-OMD	8,35
L	315	8	R 1/4" keg						GE-L-08-R 1/4"-k-OMD	7,60
L	315	8	R 3/8" keg						GE-L-08-R 3/8"-k-OMD	9,29
L	315	8	R 1/2" keg						GE-L-08-R 1/2"-k-OMD	13,25
L	315	10	R 1/8" keg						GE-L-10-R 1/8"-k-OMD	9,37
L	315	10	R 1/4" keg						GE-L-10-R 1/4"-k-OMD	8,71
L	315	10	R 3/8" keg						GE-L-10-R 3/8"-k-OMD	9,22
L	315	10	R 1/2" keg						GE-L-10-R 1/2"-k-OMD	14,08
L	315	12	R 1/8" keg						GE-L-12-R 1/8"-k-OMD	11,86
L	315	12	R 1/4" keg						GE-L-12-R 1/4"-k-OMD	10,81
L	315	12	R 3/8" keg						GE-L-12-R 3/8"-k-OMD	10,81
L	315	12	R 1/2" keg						GE-L-12-R 1/2"-k-OMD	12,73
L	160	12	R 3/4" keg						GE-L-12-R 3/4"-k-OMD	21,76
L	315	15	R 1/4" keg						GE-L-15-R 1/4"-k-OMD	14,76
L	315	15	R 3/8" keg						GE-L-15-R 3/8"-k-OMD	13,73
L	315	15	R 1/2" keg						GE-L-15-R 1/2"-k-OMD	13,68
L	160	15	R 3/4" keg						GE-L-15-R 3/4"-k-OMD	21,36
L	315	18	R 3/8" keg						GE-L-18-R 3/8"-k-OMD	15,92
L	315	18	R 1/2" keg						GE-L-18-R 1/2"-k-OMD	15,92
L	160	18	R 3/4" keg						GE-L-18-R 3/4"-k-OMD	23,28
L	160	22	R 3/8" keg						GE-L-22-R 3/8"-k-OMD	24,41
L	160	22	R 1/2" keg						GE-L-22-R 1/2"-k-OMD	22,67
L	160	22	R 3/4" keg						GE-L-22-R 3/4"-k-OMD	22,67
L	160	22	R 1" keg						GE-L-22-R 1"-k-OMD	43,12
L	160	28	R 1/2" keg						GE-L-28-R 1/2"-k-OMD	39,09
L	160	28	R 3/4" keg						GE-L-28-R 3/4"-k-OMD	39,09
L	160	28	R 1" keg						GE-L-28-R 1"-k-OMD	39,09
L	160	28	R 1 1/4" keg						GE-L-28-R 1 1/4"-k-OMD	57,75
L	160	35	R 1" keg						GE-L-35-R 1"-k-OMD	52,52
L	160	35	R 1 1/4" keg						GE-L-35-R 1 1/4"-k-OMD	52,52
L	160	35	R 1 1/2" keg						GE-L-35-R 1 1/2"-k-OMD	63,25
L	160	42	R 1 1/4" keg						GE-L-42-R 1 1/4"-k-OMD	64,09
L	160	42	R 1 1/2" keg						GE-L-42-R 1 1/2"-k-OMD	62,05

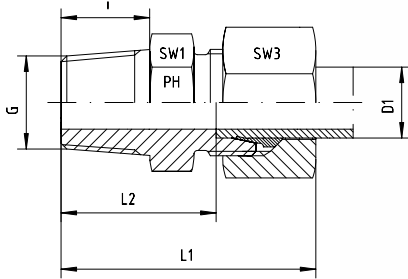

Gerade Einschraubverschraubungen

S-Reihe

Einschraubgewinde: Whitworth-Rohrgewinde - Kegelig
Andere Sprunggrößen auf Anfrage!

Male Stud Couplings

S-Series

Thread: BSP - Taper

Other jump sizes on request!

Reihe Series	Druck Pressure PN ⁽¹⁾	Rohr A.D. Tube O.D. D1	Gewinde Thread G	Ca. Maße Approx. Dimensions					Bestellzeichen Order-Code Standard	Brutto-Preis Gross-Price Euro (€)
				L1	L2	i	SW1	SW3		
S	630	6	R 1/8" keg			8	17	17	GE-S-06-R 1/8"-k	11,20
S	630	6	R 1/4" keg	40,0	25,0	12	17	17	GE-S-06-R 1/4"-k	11,56
S	630	6	R 3/8" keg	40,0	25,0	12	17	17	GE-S-06-R 3/8"-k	14,40
S	630	8	R 1/8" keg	35,0	19,0	8	17	19	GE-S-08-R 1/8"-k	14,27
S	630	8	R 1/4" keg	40,0	25,0	12	17	19	GE-S-08-R 1/4"-k	13,50
S	630	8	R 3/8" keg	40,0	25,0	12	19	19	GE-S-08-R 3/8"-k	14,60
S	630	10	R 1/4" keg	41,0	25,0	12	19	22	GE-S-10-R 1/4"-k	15,64
S	630	10	R 3/8" keg	41,0	25,0	12	19	22	GE-S-10-R 3/8"-k	16,11
S	630	10	R 1/2" keg			14	22	22	GE-S-10-R 1/2"-k	*
S	630	12	R 1/4" keg	43,0	26,5	12	22	24	GE-S-12-R 1/4"-k	17,44
S	630	12	R 3/8" keg	42,0	25,0	12	22	24	GE-S-12-R 3/8"-k	18,38
S	630	12	R 1/2" keg	44,0	26,5	14	22	24	GE-S-12-R 1/2"-k	17,64
S	630	14	R 3/8" keg	46,0	27,0	12	24	27	GE-S-14-R 3/8"-k	23,95
S	630	14	R 1/2" keg	50,5	32,0	14	24	27	GE-S-14-R 1/2"-k	21,53
S	400	16	R 3/8" keg	48,0	28,5	12	27	30	GE-S-16-R 3/8"-k	27,81
S	400	16	R 1/2" keg	49,0	29,0	14	27	30	GE-S-16-R 1/2"-k	29,40
S	400	16	R 3/4" keg	53,0	31,5	16	27	30	GE-S-16-R 3/4"-k	39,80
S	400	20	R 1/2" keg	54,0	29,5	14	32	36	GE-S-20-R 1/2"-k	36,81
S	400	20	R 3/4" keg	55,0	33,5	16	32	36	GE-S-20-R 3/4"-k	37,07
S	160	20	R 1" keg	58,0	35,5	18	36	36	GE-S-20-R 1"-k	*
S	160	25	R 3/4" keg			16	41	46	GE-S-25-R 3/4"-k	*
S	160	25	R 1" keg	59,0	33,0	18	41	46	GE-S-25-R 1"-k	58,29
S	160	30	R 1 1/4" keg	63,0	35,5	20	46	50	GE-S-30-R 1 1/4"-k	79,25
S	160	38	R 1 1/2" keg	81,0	49,0	22	55	60	GE-S-38-R 1 1/2"-k	112,49

⁽¹⁾ Die angegebenen Druckstufen sind nur gültig, wenn die Einschraublöcher mit kegeligem Gewinde vorhanden sind.

⁽¹⁾ The pressure rates are only valid, if the female parts are with tapered threads, too.

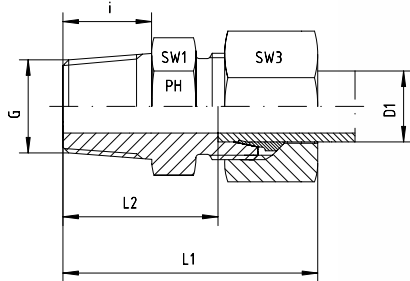

Gerade Einschraubverschraubungen

S-Reihe

Einschraubgewinde: Whitworth-Rohrgewinde - Kegelig
Andere Sprunggrößen auf Anfrage!

Male Stud Couplings

S-Series

Thread: BSP - Taper

Other jump sizes on request!

Reihe Series	Druck Pressure PN ⁽¹⁾	Rohr A.D. Tube O.D. D1	Gewinde Thread G	Ca. Maße Approx. Dimensions					Bestellzeichen Order-Code SC	Brutto-Preis Gross-Price Euro (€)
				L1	L2	i	SW1	SW3		
S	630	6	R 1/8" keg			8	17	17	GE-S-06-R 1/8"-k-SC	*
S	630	6	R 1/4" keg	40,0	25,0	12	17	17	GE-S-06-R 1/4"-k-SC	12,00
S	630	6	R 3/8" keg	40,0	25,0	12	17	17	GE-S-06-R 3/8"-k-SC	14,97
S	630	8	R 1/8" keg	35,0	19,0	8	17	19	GE-S-08-R 1/8"-k-SC	14,71
S	630	8	R 1/4" keg	40,0	25,0	12	17	19	GE-S-08-R 1/4"-k-SC	13,94
S	630	8	R 3/8" keg	40,0	25,0	12	19	19	GE-S-08-R 3/8"-k-SC	15,04
S	630	10	R 1/4" keg	41,0	25,0	12	19	22	GE-S-10-R 1/4"-k-SC	16,20
S	630	10	R 3/8" keg	41,0	25,0	12	19	22	GE-S-10-R 3/8"-k-SC	16,67
S	630	10	R 1/2" keg			14	22	22	GE-S-10-R 1/2"-k-SC	*
S	630	12	R 1/4" keg	43,0	26,5	12	22	24	GE-S-12-R 1/4"-k-SC	18,28
S	630	12	R 3/8" keg	42,0	25,0	12	22	24	GE-S-12-R 3/8"-k-SC	19,22
S	630	12	R 1/2" keg	44,0	26,5	14	22	24	GE-S-12-R 1/2"-k-SC	18,48
S	630	14	R 3/8" keg			12	24	27	GE-S-14-R 3/8"-k-SC	25,51
S	630	14	R 1/2" keg	50,5	32,0	14	24	27	GE-S-14-R 1/2"-k-SC	23,09
S	400	16	R 3/8" keg	48,0	28,5	12	27	30	GE-S-16-R 3/8"-k-SC	29,37
S	400	16	R 1/2" keg	49,0	29,0	14	27	30	GE-S-16-R 1/2"-k-SC	30,96
S	400	16	R 3/4" keg	53,0	31,5	16	27	30	GE-S-16-R 3/4"-k-SC	41,78
S	400	20	R 1/2" keg	54,0	29,5	14	32	36	GE-S-20-R 1/2"-k-SC	38,69
S	400	20	R 3/4" keg	55,0	33,5	16	32	36	GE-S-20-R 3/4"-k-SC	38,95
S	160	20	R 1" keg	58,0	35,5	18	36	36	GE-S-20-R 1"-k-SC	*
S	160	25	R 3/4" keg			16	41	46	GE-S-25-R 3/4"-k-SC	*
S	160	25	R 1" keg	59,0	33,0	18	41	46	GE-S-25-R 1"-k-SC	61,29
S	160	30	R 1 1/4" keg	63,0	35,5	20	46	50	GE-S-30-R 1 1/4"-k-SC	83,41
S	160	38	R 1 1/2" keg	81,0	49,0	22	55	60	GE-S-38-R 1 1/2"-k-SC	*

⁽¹⁾ Die angegebenen Druckstufen sind nur gültig, wenn die Einschraublöcher mit kegeligem Gewinde vorhanden sind.

⁽¹⁾ The pressure rates are only valid, if the female parts are with tapered threads, too.



Gerade Einschraubverschraubungsstutzen

S-Reihe

Einschraubgewinde: Whitworth-Rohrgewinde - Kegelig
Andere Sprunggrößen auf Anfrage!

Male Stud Coupling Bodies

S-Series

Thread: BSP - Taper

Other jump sizes on request!

Reihe Series	Druck Pressure PN ⁽¹⁾	Rohr A.D. Tube O.D. D1	Gewinde Thread G	Ca. Maße Approx. Dimensions					Bestellzeichen Order-Code OMD	Brutto-Preis Gross-Price Euro (€)
S	630	6	R 1/8" keg						GE-S-06-R 1/8"-k-OMD	*
S	630	6	R 1/4" keg						GE-S-06-R 1/4"-k-OMD	8,77
S	630	6	R 3/8" keg						GE-S-06-R 3/8"-k-OMD	11,61
S	630	8	R 1/8" keg						GE-S-08-R 1/8"-k-OMD	11,07
S	630	8	R 1/4" keg						GE-S-08-R 1/4"-k-OMD	10,30
S	630	8	R 3/8" keg						GE-S-08-R 3/8"-k-OMD	11,40
S	630	10	R 1/4" keg						GE-S-10-R 1/4"-k-OMD	11,70
S	630	10	R 3/8" keg						GE-S-10-R 3/8"-k-OMD	12,17
S	630	10	R 1/2" keg						GE-S-10-R 1/2"-k-OMD	*
S	630	12	R 1/4" keg						GE-S-12-R 1/4"-k-OMD	12,99
S	630	12	R 3/8" keg						GE-S-12-R 3/8"-k-OMD	13,93
S	630	12	R 1/2" keg						GE-S-12-R 1/2"-k-OMD	13,19
S	630	14	R 3/8" keg						GE-S-14-R 3/8"-k-OMD	18,45
S	630	14	R 1/2" keg						GE-S-14-R 1/2"-k-OMD	16,03
S	400	16	R 3/8" keg						GE-S-16-R 3/8"-k-OMD	19,60
S	400	16	R 1/2" keg						GE-S-16-R 1/2"-k-OMD	21,19
S	400	16	R 3/4" keg						GE-S-16-R 3/4"-k-OMD	31,59
S	400	20	R 1/2" keg						GE-S-20-R 1/2"-k-OMD	26,23
S	400	20	R 3/4" keg						GE-S-20-R 3/4"-k-OMD	26,49
S	160	20	R 1" keg						GE-S-20-R 1"-k-OMD	*
S	160	25	R 3/4" keg						GE-S-25-R 3/4"-k-OMD	*
S	160	25	R 1" keg						GE-S-25-R 1"-k-OMD	39,67
S	160	30	R 1 1/4" keg						GE-S-30-R 1 1/4"-k-OMD	55,81
S	160	38	R 1 1/2" keg						GE-S-38-R 1 1/2"-k-OMD	80,68

⁽¹⁾ Die angegebenen Druckstufen sind nur gültig, wenn die Einschraublöcher mit kegeligem Gewinde vorhanden sind.

⁽¹⁾ The pressure rates are only valid, if the female parts are with tapered threads, too.

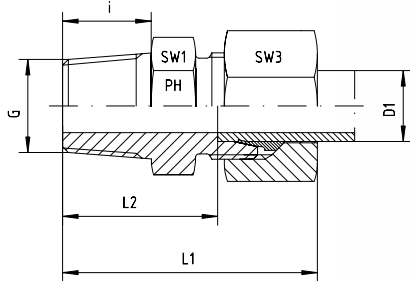

Gerade Einschraubverschraubungen
LL- und L-Reihe
Einschraubgewinde: Metrisches Feingewinde - Kegelig

Male Stud Couplings
LL- and L-Series
Thread: Metric - Taper

Reihe Series	Druck Pressure PN	Rohr A.D. Tube O.D. D1	Gewinde Thread G	Ca. Maße Approx. Dimensions					Bestellzeichen Order-Code Standard	Brutto-Preis Gross-Price Euro (€)
				L1	L2	i	SW1	SW3		
LL	100	4	M 6 x 1 keg	26,0	16,0	8	10	10	GE-LL-04-M 6x1-k	8,41
LL	100	4	M 8 x 1 keg	26,0	16,0	8	10	10	GE-LL-04-M 8x1-k	8,41
LL	100	4	M 10 x 1 keg	26,0	16,0	8	11	10	GE-LL-04-M 10x1-k	8,95
LL	100	6	M 6 x 1 keg	26,0	14,5	8	11	12	GE-LL-06-M 6x1-k	9,31
LL	100	6	M 8 x 1 keg	26,0	14,5	8	11	12	GE-LL-06-M 8x1-k	9,31
LL	100	6	M 10 x 1 keg	26,0	14,5	8	11	12	GE-LL-06-M 10x1-k	9,31
LL	100	8	M 6 x 1 keg	28,0	16,5	8	12	14	GE-LL-08-M 6x1-k	10,02
LL	100	8	M 8 x 1 keg	28,0	16,5	8	12	14	GE-LL-08-M 8x1-k	10,02
LL	100	8	M 10 x 1 keg	28,0	16,5	8	12	14	GE-LL-08-M 10x1-k	10,02

Reihe Series	Druck Pressure PN	Rohr A.D. Tube O.D. D1	Gewinde Thread G	Ca. Maße Approx. Dimensions					Bestellzeichen Order-Code Standard	Brutto-Preis Gross-Price Euro (€)
				L1	L2	i	SW1	SW3		
L	315	6	M 10 x 1 keg	30,5	16,0	8	14	14	GE-L-06-M 10x1-k	9,71
L	315	8	M 12 x 1,5 keg	35,0	20,0	12	17	17	GE-L-08-M 12x1,5-k	10,48
L	315	10	M 14 x 1,5 keg	36,0	21,0	12	17	19	GE-L-10-M 14x1,5-k	12,02
L	315	12	M 16 x 1,5 keg	37,0	22,0	12	19	22	GE-L-12-M 16x1,5-k	14,62
L	315	15	M 18 x 1,5 keg	40,0	23,0	12	24	27	GE-L-15-M 18x1,5-k	15,59
L	315	18	M 22 x 1,5 keg	42,0	25,5	14	27	32	GE-L-18-M 22x1,5-k	25,80



Gerade Einschraubverschraubungen
 L-Reihe
 Einschraubgewinde: Metrisches Feingewinde - Kegelig

Male Stud Couplings
 L-Series
 Thread: Metric - Taper

Reihe Series	Druck Pressure PN	Rohr A.D. Tube O.D. D1	Gewinde Thread G	Ca. Maße Approx. Dimensions					Bestellzeichen Order-Code SC	Brutto-Preis Gross-Price Euro (€)
				L1	L2	i	SW1	SW3		
L	315	6	M 10 x 1 keg	30,5	16,0	8	14	14	GE-L-06-M 10x1-k-SC	10,03
L	315	8	M 12 x 1,5 keg	35,0	20,0	12	17	17	GE-L-08-M 12x1,5-k-SC	10,92
L	315	10	M 14 x 1,5 keg	36,0	21,0	12	17	19	GE-L-10-M 14x1,5-k-SC	12,46
L	315	12	M 16 x 1,5 keg	37,0	22,0	12	19	22	GE-L-12-M 16x1,5-k-SC	15,18
L	315	15	M 18 x 1,5 keg	40,0	23,0	12	24	27	GE-L-15-M 18x1,5-k-SC	16,67
L	315	18	M 22 x 1,5 keg	42,0	25,5	14	27	32	GE-L-18-M 22x1,5-k-SC	27,44



Gerade Einschraubverschraubungsstutzen
LL- und L-Reihe
Einschraubgewinde: Metrisches Feingewinde - Kegelig

Male Stud Coupling Bodies
LL- and L-Series
Thread: Metric - Taper

Reihe Series	Druck Pressure PN	Rohr A.D. Tube O.D. D1	Gewinde Thread G	Ca. Maße Approx. Dimensions					Bestellzeichen Order-Code OMD	Brutto-Preis Gross-Price Euro (€)
LL	100	4	M 6 x 1 keg						GE-LL-04-M 6x1-k-OMD	5,75
LL	100	4	M 8 x 1 keg						GE-LL-04-M 8x1-k-OMD	5,75
LL	100	4	M 10 x 1 keg						GE-LL-04-M 10x1-k-OMD	6,29
LL	100	6	M 6 x 1 keg						GE-LL-06-M 6x1-k-OMD	6,27
LL	100	6	M 8 x 1 keg						GE-LL-06-M 8x1-k-OMD	6,27
LL	100	6	M 10 x 1 keg						GE-LL-06-M 10x1-k-OMD	6,27
LL	100	8	M 6 x 1 keg						GE-LL-08-M 6x1-k-OMD	6,52
LL	100	8	M 8 x 1 keg						GE-LL-08-M 8x1-k-OMD	6,52
LL	100	8	M 10 x 1 keg						GE-LL-08-M 10x1-k-OMD	6,52

Reihe Series	Druck Pressure PN	Rohr A.D. Tube O.D. D1	Gewinde Thread G	Ca. Maße Approx. Dimensions					Bestellzeichen Order-Code OMD	Brutto-Preis Gross-Price Euro (€)
L	315	6	M 10 x 1 keg						GE-L-06-M 10x1-k-OMD	7,40
L	315	8	M 12 x 1,5 keg						GE-L-08-M 12x1,5-k-OMD	7,68
L	315	10	M 14 x 1,5 keg						GE-L-10-M 14x1,5-k-OMD	8,66
L	315	12	M 16 x 1,5 keg						GE-L-12-M 16x1,5-k-OMD	10,73
L	315	15	M 18 x 1,5 keg						GE-L-15-M 18x1,5-k-OMD	10,45
L	315	18	M 22 x 1,5 keg						GE-L-18-M 22x1,5-k-OMD	17,18

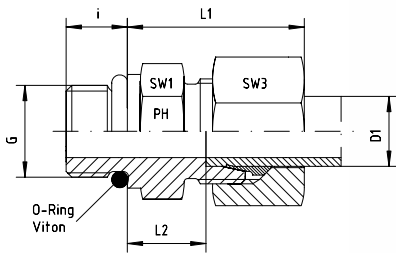

Gerade Einschraubverschraubungen

L-Reihe

Einschraubgewinde: UNF (ASA B 1.1 - 1960)

Abdichtung durch Runddichtring (O-Ring) - SAE J 514

Achtung: Spezielle Gewindeausenkung erforderlich.

Andere Sprunggrößen auf Anfrage!

Male Stud Couplings

L-Series

Thread: UNF (ASA B 1.1 - 1960)

Sealing by O-ring in Thread Undercut - SAE J 514

Note: A special part shape must be machined.

Other jump sizes on request!

Reihe Series	Druck Pressure PN	Rohr A.D. Tube O.D. D1	Gewinde Thread G	Ca. Maße Approx. Dimensions					O-Ring O-ring	Bestellzeichen Order-Code Standard	Brutto-Preis Gross-Price Euro (€)
				L1	L2	i	SW1	SW3			
L	315	6	7/16"-20 UNF	23,5	9,0	9,2	17	14	8,92 x 1,83	GE-L-06-7/16"-UNF	22,71
L	315	6	1/2"-20 UNF		10,0	9,2	17	14	10,52 x 1,83	GE-L-06-1/2"-UNF	22,71
L	315	6	9/16"-18 UNF			10,0	19	14	11,90 x 1,98	GE-L-06-9/16"-UNF	22,71
L	315	8	7/16"-20 UNF	25,0	10,0	9,2	17	17	8,92 x 1,83	GE-L-08-7/16"-UNF	23,20
L	315	8	1/2"-20 UNF	25,0	10,0	9,2	17	17	10,52 x 1,83	GE-L-08-1/2"-UNF	23,20
L	315	8	9/16"-18 UNF	25,0	10,0	10,0	19	17	11,90 x 1,98	GE-L-08-9/16"-UNF	23,20
L	315	10	7/16"-20 UNF	26,0	11,0	9,2	17	19	8,92 x 1,83	GE-L-10-7/16"-UNF	23,76
L	315	10	1/2"-20 UNF	26,0	11,0	9,2	17	19	10,52 x 1,83	GE-L-10-1/2"-UNF	23,76
L	315	10	9/16"-18 UNF	26,0	11,0	10,0	19	19	11,90 x 1,98	GE-L-10-9/16"-UNF	23,76
L	315	10	3/4"-16 UNF	30,5	13,0	11,2	24	19	16,36 x 2,20	GE-L-10-3/4"-UNF	25,41
L	315	12	9/16"-18 UNF	26,0	12,5	10,0	19	22	11,90 x 1,98	GE-L-12-9/16"-UNF	23,76
L	315	12	3/4"-16 UNF	27,0	12,5	11,2	24	22	16,36 x 2,20	GE-L-12-3/4"-UNF	25,94
L	315	12	7/8"-14 UNF	27,5	13,5	12,7	27	22	19,18 x 2,46	GE-L-12-7/8"-UNF	26,64
L	315	15	9/16"-18 UNF	29,0	14,0	10,0	24	27	11,90 x 1,98	GE-L-15-9/16"-UNF	28,99
L	315	15	3/4"-16 UNF	29,0	14,0	11,2	24	27	16,36 x 2,20	GE-L-15-3/4"-UNF	27,19
L	315	15	7/8"-14 UNF	29,0	14,0	12,7	27	27	19,18 x 2,46	GE-L-15-7/8"-UNF	27,89
L	315	18	3/4"-16 UNF	31,0	14,5	11,2	27	32	16,36 x 2,20	GE-L-18-3/4"-UNF	32,47
L	315	18	7/8"-14 UNF	31,0	14,5	12,7	27	32	19,18 x 2,46	GE-L-18-7/8"-UNF	32,47
L	315	18	1 1/16"-12 UN	31,0	14,5	15,0	32	32	23,47 x 2,95	GE-L-18-1 1/16"-UN	45,42
L	160	22	3/4"-16 UNF	33,0	16,5	11,2	32	36	16,36 x 2,20	GE-L-22-3/4"-UNF	48,01
L	160	22	7/8"-14 UNF	33,0	16,5	12,7	32	36	19,18 x 2,46	GE-L-22-7/8"-UNF	48,01
L	160	22	1 1/16"-12 UN	33,0	16,5	15,0	32	36	23,47 x 2,95	GE-L-22-1 1/16"-UN	46,41
L	160	22	1 5/16"-12 UN	33,0	16,5	15,0	41	36	29,74 x 2,95	GE-L-22-1 5/16"-UN	65,16
L	160	28	7/8"-14 UNF	34,0	17,5	12,7	41	41	19,18 x 2,46	GE-L-28-7/8"-UNF	*
L	160	28	1 1/16"-12 UN	34,0	17,5	15,0	41	41	23,47 x 2,95	GE-L-28-1 1/16"-UN	69,65
L	160	28	1 5/16"-12 UN	34,0	17,5	15,0	41	41	29,74 x 2,95	GE-L-28-1 5/16"-UN	68,80
L	160	28	1 5/8"-12 UN	34,0	17,5	15,0	50	41	37,46 x 3,00	GE-L-28-1 5/8"-UN	196,50
L	160	35	1 1/16"-12 UN	39,0	17,5	15,0	46	50	23,47 x 2,95	GE-L-35-1 1/16"-UN	*
L	160	35	1 5/16"-12 UN	39,0	17,5	15,0	46	50	29,74 x 2,95	GE-L-35-1 5/16"-UN	154,00
L	160	35	1 5/8"-12 UN	39,0	17,5	15,0	50	50	37,46 x 3,00	GE-L-35-1 5/8"-UN	149,11
L	160	42	1 5/8"-12 UN	42,0	19,0	15,0	55	60	37,46 x 3,00	GE-L-42-1 5/8"-UN	201,00
L	160	42	1 7/8"-12 UN	42,0	19,0	15,0	55	60	43,69 x 3,00	GE-L-42-1 7/8"-UN	201,00

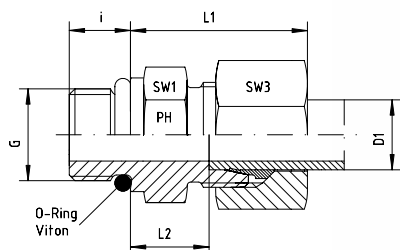

Gerade Einschraubverschraubungen

L-Reihe

Einschraubgewinde: UNF (ASA B 1.1 - 1960)

Abdichtung durch Runddichtring (O-Ring) - SAE J 514

Achtung: Spezielle Gewindeausenkung erforderlich.

Andere Sprunggrößen auf Anfrage!

Male Stud Couplings

L-Series

Thread: UNF (ASA B 1.1 - 1960)

Sealing by O-ring in Thread Undercut - SAE J 514

Note: A special part shape must be machined.

Other jump sizes on request!

Reihe Series	Druck Pressure PN	Rohr A.D. Tube O.D. D1	Gewinde Thread G	Ca. Maße Approx. Dimensions					O-Ring O-ring	Bestellzeichen Order-Code SC	Brutto-Preis Gross-Price Euro (€)
				L1	L2	i	SW1	SW3			
L	315	6	7/16"-20 UNF	23,5	9,0	9,2	17	14	8,92 x 1,83	GE-L06-7/16"-UNF-SC	23,03
L	315	6	1/2"-20 UNF		10,0	9,2	17	14	10,52 x 1,83	GE-L06-1/2"-UNF-SC	23,03
L	315	6	9/16"-18 UNF			10,0	19	14	11,90 x 1,98	GE-L06-9/16"-UNF-SC	23,03
L	315	8	7/16"-20 UNF	25,0	10,0	9,2	17	17	8,92 x 1,83	GE-L08-7/16"-UNF-SC	23,64
L	315	8	1/2"-20 UNF	25,0	10,0	9,2	17	17	10,52 x 1,83	GE-L08-1/2"-UNF-SC	23,64
L	315	8	9/16"-18 UNF	25,0	10,0	10,0	19	17	11,90 x 1,98	GE-L08-9/16"-UNF-SC	23,64
L	315	10	7/16"-20 UNF	26,0	11,0	9,2	17	19	8,92 x 1,83	GE-L10-7/16"-UNF-SC	24,20
L	315	10	1/2"-20 UNF	26,0	11,0	9,2	17	19	10,52 x 1,83	GE-L10-1/2"-UNF-SC	24,20
L	315	10	9/16"-18 UNF	26,0	11,0	10,0	19	19	11,90 x 1,98	GE-L10-9/16"-UNF-SC	24,20
L	315	10	3/4"-16 UNF	30,5	13,0	11,2	24	19	16,36 x 2,20	GE-L10-3/4"-UNF-SC	25,85
L	315	12	9/16"-18 UNF	26,0	12,5	10,0	19	22	11,90 x 1,98	GE-L12-9/16"-UNF-SC	24,20
L	315	12	3/4"-16 UNF	27,0	12,5	11,2	24	22	16,36 x 2,20	GE-L12-3/4"-UNF-SC	26,50
L	315	12	7/8"-14 UNF	27,5	13,5	12,7	27	22	19,18 x 2,46	GE-L12-7/8"-UNF-SC	27,20
L	315	15	9/16"-18 UNF	29,0	14,0	10,0	24	27	11,90 x 1,98	GE-L15-9/16"-UNF-SC	30,07
L	315	15	3/4"-16 UNF	29,0	14,0	11,2	24	27	16,36 x 2,20	GE-L15-3/4"-UNF-SC	28,27
L	315	15	7/8"-14 UNF	29,0	14,0	12,7	27	27	19,18 x 2,46	GE-L15-7/8"-UNF-SC	28,97
L	315	18	3/4"-16 UNF	31,0	14,5	11,2	27	32	16,36 x 2,20	GE-L18-3/4"-UNF-SC	34,11
L	315	18	7/8"-14 UNF	31,0	14,5	12,7	27	32	19,18 x 2,46	GE-L18-7/8"-UNF-SC	34,11
L	315	18	1 1/16"-12 UN	31,0	14,5	15,0	32	32	23,47 x 2,95	GE-L18-1 1/16"-UN-SC	47,06
L	160	22	3/4"-16 UNF	33,0	16,5	11,2	32	36	16,36 x 2,20	GE-L22-3/4"-UNF-SC	49,77
L	160	22	7/8"-14 UNF	33,0	16,5	12,7	32	36	19,18 x 2,46	GE-L22-7/8"-UNF-SC	49,77
L	160	22	1 1/16"-12 UN	33,0	16,5	15,0	32	36	23,47 x 2,95	GE-L22-1 1/16"-UN-SC	48,17
L	160	22	1 5/16"-12 UN	33,0	16,5	15,0	41	36	29,74 x 2,95	GE-L22-1 5/16"-UN-SC	66,92
L	160	28	7/8"-14 UNF	34,0	17,5	12,7	41	41	19,18 x 2,46	GE-L28-7/8"-UNF-SC	*
L	160	28	1 1/16"-12 UN	34,0	17,5	15,0	41	41	23,47 x 2,95	GE-L28-1 1/16"-UN-SC	71,65
L	160	28	1 5/16"-12 UN	34,0	17,5	15,0	41	41	29,74 x 2,95	GE-L28-1 5/16"-UN-SC	70,80
L	160	28	1 5/8"-12 UN	34,0	17,5	15,0	50	41	37,46 x 3,00	GE-L28-1 5/8"-UN-SC	198,50
L	160	35	1 1/16"-12 UN	39,0	17,5	15,0	46	50	23,47 x 2,95	GE-L35-1 1/16"-UN-SC	*
L	160	35	1 5/16"-12 UN	39,0	17,5	15,0	46	50	29,74 x 2,95	GE-L35-1 5/16"-UN-SC	*
L	160	35	1 5/8"-12 UN	39,0	17,5	15,0	50	50	37,46 x 3,00	GE-L35-1 5/8"-UN-SC	153,43
L	160	42	1 5/8"-12 UN	42,0	19,0	15,0	55	60	37,46 x 3,00	GE-L42-1 5/8"-UN-SC	*
L	160	42	1 7/8"-12 UN	42,0	19,0	15,0	55	60	43,69 x 3,00	GE-L42-1 7/8"-UN-SC	*



Gerade Einschraubverschraubungsstutzen
L-Reihe

Einschraubgewinde: UNF (ASA B 1.1 - 1960)

Abdichtung durch Runddichtring (O-Ring) - SAE J 514

Achtung: Spezielle Gewindeausenkung erforderlich.

Andere Sprunggrößen auf Anfrage!

Male Stud Coupling Bodies

L-Series

Thread: UNF (ASA B 1.1 - 1960)

Sealing by O-ring in Thread Undercut - SAE J 514

Note: A special part shape must be machined.

Other jump sizes on request!

Reihe Series	Druck Pressure PN	Rohr A.D. Tube O.D. D1	Gewinde Thread G	Ca. Maße Approx. Dimensions				O-Ring O-ring	Bestellzeichen Order-Code OMD	Brutto-Preis Gross-Price Euro (€)
L	315	6	7/16"-20 UNF					8,92 x 1,83	GE-L-06-7/16"-UNF-OMD	20,40
L	315	6	1/2"-20 UNF					10,52 x 1,83	GE-L-06-1/2"-UNF-OMD	20,40
L	315	6	9/16"-18 UNF					11,90 x 1,98	GE-L-06-9/16"-UNF-OMD	20,40
L	315	8	7/16"-20 UNF					8,92 x 1,83	GE-L-08-7/16"-UNF-OMD	20,40
L	315	8	1/2"-20 UNF					10,52 x 1,83	GE-L-08-1/2"-UNF-OMD	20,40
L	315	8	9/16"-18 UNF					11,90 x 1,98	GE-L-08-9/16"-UNF-OMD	20,40
L	315	10	7/16"-20 UNF					8,92 x 1,83	GE-L-10-7/16"-UNF-OMD	20,40
L	315	10	1/2"-20 UNF					10,52 x 1,83	GE-L-10-1/2"-UNF-OMD	20,40
L	315	10	9/16"-18 UNF					11,90 x 1,98	GE-L-10-9/16"-UNF-OMD	20,40
L	315	10	3/4"-16 UNF					16,36 x 2,20	GE-L-10-3/4"-UNF-OMD	22,05
L	315	12	9/16"-18 UNF					11,90 x 1,98	GE-L-12-9/16"-UNF-OMD	20,40
L	315	12	3/4"-16 UNF					16,36 x 2,20	GE-L-12-3/4"-UNF-OMD	22,05
L	315	12	7/8"-14 UNF					19,18 x 2,46	GE-L-12-7/8"-UNF-OMD	22,75
L	315	15	9/16"-18 UNF					11,90 x 1,98	GE-L-15-9/16"-UNF-OMD	23,85
L	315	15	3/4"-16 UNF					16,36 x 2,20	GE-L-15-3/4"-UNF-OMD	22,05
L	315	15	7/8"-14 UNF					19,18 x 2,46	GE-L-15-7/8"-UNF-OMD	22,75
L	315	18	3/4"-16 UNF					16,36 x 2,20	GE-L-18-3/4"-UNF-OMD	23,85
L	315	18	7/8"-14 UNF					19,18 x 2,46	GE-L-18-7/8"-UNF-OMD	23,85
L	315	18	1 1/16"-12 UN					23,47 x 2,95	GE-L-18-1 1/16"-UN-OMD	36,80
L	160	22	3/4"-16 UNF					16,36 x 2,20	GE-L-22-3/4"-UNF-OMD	37,70
L	160	22	7/8"-14 UNF					19,18 x 2,46	GE-L-22-7/8"-UNF-OMD	37,70
L	160	22	1 1/16"-12 UN					23,47 x 2,95	GE-L-22-1 1/16"-UN-OMD	36,10
L	160	22	1 5/16"-12 UN					29,74 x 2,95	GE-L-22-1 5/16"-UN-OMD	54,85
L	160	28	7/8"-14 UNF					19,18 x 2,46	GE-L-28-7/8"-UNF-OMD	*
L	160	28	1 1/16"-12 UN					23,47 x 2,95	GE-L-28-1 1/16"-UN-OMD	54,80
L	160	28	1 5/16"-12 UN					29,74 x 2,95	GE-L-28-1 5/16"-UN-OMD	53,95
L	160	28	1 5/8"-12 UN					37,46 x 3,00	GE-L-28-1 5/8"-UN-OMD	181,65
L	160	35	1 1/16"-12 UN					23,47 x 2,95	GE-L-35-1 1/16"-UN-OMD	*
L	160	35	1 5/16"-12 UN					29,74 x 2,95	GE-L-35-1 5/16"-UN-OMD	132,89
L	160	35	1 5/8"-12 UN					37,46 x 3,00	GE-L-35-1 5/8"-UN-OMD	128,00
L	160	42	1 5/8"-12 UN					37,46 x 3,00	GE-L-42-1 5/8"-UN-OMD	173,57
L	160	42	1 7/8"-12 UN					43,69 x 3,00	GE-L-42-1 7/8"-UN-OMD	173,57

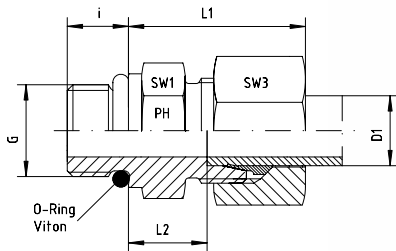

Gerade Einschraubverschraubungen

S-Reihe

Einschraubgewinde: UNF (ASA B 1.1 - 1960)

Abdichtung durch Runddichtring (O-Ring) - SAE J 514

Achtung: Spezielle Gewindeausenkung erforderlich.

Andere Sprunggrößen auf Anfrage!

Male Stud Couplings

S-Series

Thread: UNF (ASA B 1.1 -1960)

Sealing by O-ring in Thread Undercut - SAE J 514

Note: A special part shape must be machined.

Other jump sizes on request!

Reihe Series	Druck Pressure PN	Rohr A.D. Tube O.D. D1	Gewinde Thread G	Ca. Maße Approx. Dimensions					O-Ring O-ring	Bestellzeichen Order-Code Standard	Brutto-Preis Gross-Price Euro (€)
				L1	L2	i	SW1	SW3			
S	630	6	7/16"-20 UNF	28,0	13,0	9,2	17	17	8,92 x 1,83	GE-S-06-7/16"-UNF	23,19
S	630	6	9/16"-18 UNF	29,0	13,0	10,0	19	17	11,90 x 1,98	GE-S-06-9/16"-UNF	23,90
S	630	8	7/16"-20 UNF	30,0	15,0	9,2	17	19	8,92 x 1,83	GE-S-08-7/16"-UNF	23,60
S	630	8	1/2"-20 UNF	30,0	15,0	9,2	17	19	10,52 x 1,83	GE-S-08-1/2"-UNF	23,60
S	630	8	9/16"-18 UNF	30,0	13,0	10,0	19	19	11,90 x 1,98	GE-S-08-9/16"-UNF	23,60
S	630	10	9/16"-18 UNF	31,0	15,5	10,0	19	22	11,90 x 1,98	GE-S-10-9/16"-UNF	24,34
S	630	10	3/4"-16 UNF	31,0	15,0	11,2	24	22	16,36 x 2,20	GE-S-10-3/4"-UNF	25,99
S	630	12	9/16"-18 UNF		14,5	10,0	22	24	11,90 x 1,98	GE-S-12-9/16"-UNF	26,40
S	630	12	3/4"-16 UNF	33,5	17,5	11,2	24	24	16,36 x 2,20	GE-S-12-3/4"-UNF	26,50
S	630	12	7/8"-14 UNF	32,5	14,8	12,7	27	24	19,18 x 2,46	GE-S-12-7/8"-UNF	27,20
S	630	14	9/16"-18 UNF	37,0	19,0	10,0	24	27	11,90 x 1,98	GE-S-14-9/16"-UNF	*
S	630	14	3/4"-16 UNF	37,0	19,0	11,2	24	27	16,36 x 2,20	GE-S-14-3/4"-UNF	30,26
S	400	16	3/4"-16 UNF	37,0	18,5	11,2	27	30	16,36 x 2,20	GE-S-16-3/4"-UNF	30,26
S	400	16	7/8"-14 UNF	33,5	15,5	14,0	30	30	19,18 x 2,46	GE-S-16-7/8"-UNF	32,06
S	400	16	1 1/16"-12 UN	37,0	18,5	15,0	32	30	23,47 x 2,95	GE-S-16-1 1/16"-UN	44,31
S	400	20	3/4"-16 UNF	42,0	20,5	11,2	32	36	16,36 x 2,20	GE-S-20-3/4"-UNF	46,68
S	400	20	7/8"-14 UNF	42,0	20,5	12,7	32	36	19,18 x 2,46	GE-S-20-7/8"-UNF	46,68
S	400	20	1 1/16"-12 UN	42,0	20,5	15,0	32	36	23,47 x 2,95	GE-S-20-1 1/16"-UN	46,68
S	400	20	1 5/16"-12 UN		22,5	15,0	41	36	29,74 x 2,95	GE-S-20-1 5/16"-UN	72,15
S	400	25	1 1/16"-12 UN	47,0	23,0	15,0	41	46	23,47 x 2,95	GE-S-25-1 1/16"-UN	72,57
S	400	25	1 5/16"-12 UN	47,0	23,0	15,0	41	46	29,74 x 2,95	GE-S-25-1 5/16"-UN	72,57
S	400	30	1 1/16"-12 UN	50,0	23,5	15,0	46	50	23,47 x 2,95	GE-S-30-1 1/16"-UN	174,88
S	400	30	1 5/16"-12 UN	50,0	23,5	15,0	46	50	29,74 x 2,95	GE-S-30-1 5/16"-UN	151,44
S	400	30	1 5/8"-12 UN	50,0	23,5	15,0	50	50	37,46 x 3,00	GE-S-30-1 5/8"-UN	151,44
S	315	38	1 5/8"-12 UN	57,0	26,0	15,0	55	60	37,46 x 3,00	GE-S-38-1 5/8"-UN	201,21
S	315	38	1 7/8"-12 UN	57,0	26,0	15,0	55	60	43,69 x 3,00	GE-S-38-1 7/8"-UN	201,21

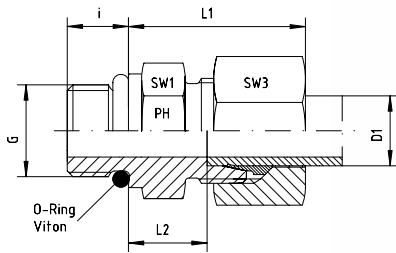

Gerade Einschraubverschraubungen

S-Reihe

Einschraubgewinde: UNF (ASA B 1.1 - 1960)

Abdichtung durch Runddichtring (O-Ring) - SAE J 514

Achtung: Spezielle Gewindeausenkung erforderlich.

Andere Sprunggrößen auf Anfrage!

Male Stud Couplings

S-Series

Thread: UNF (ASA B 1.1 -1960)

Sealing by O-ring in Thread Undercut - SAE J 514

Note: A special part shape must be machined.

Other jump sizes on request!

Reihe Series	Druck Pressure PN	Rohr A.D. Tube O.D. D1	Gewinde Thread G	Ca. Maße Approx. Dimensions					O-Ring O-ring	Bestellzeichen Order-Code SC	Brutto-Preis Gross-Price Euro (€)
				L1	L2	i	SW1	SW3			
S	630	6	7/16"-20 UNF	28,0	13,0	9,2	17	17	8,92 x 1,83	GE-S-06-7/16"-UNF-SC	23,63
S	630	6	9/16"-18 UNF	29,0	13,0	10,0	19	17	11,90 x 1,98	GE-S-06-9/16"-UNF-SC	24,47
S	630	8	7/16"-20 UNF	30,0	15,0	9,2	17	19	8,92 x 1,83	GE-S-08-7/16"-UNF-SC	24,04
S	630	8	1/2"-20 UNF	30,0	15,0	9,2	17	19	10,52 x 1,83	GE-S-08-1/2"-UNF-SC	24,04
S	630	8	9/16"-18 UNF	30,0	13,0	10,0	19	19	11,90 x 1,98	GE-S-08-9/16"-UNF-SC	24,04
S	630	10	9/16"-18 UNF	31,0	15,5	10,0	19	22	11,90 x 1,98	GE-S-10-9/16"-UNF-SC	24,90
S	630	10	3/4"-16 UNF	31,0	15,0	11,2	24	22	16,36 x 2,20	GE-S-10-3/4"-UNF-SC	26,55
S	630	12	9/16"-18 UNF		14,5	10,0	22	24	11,90 x 1,98	GE-S-12-9/16"-UNF-SC	27,24
S	630	12	3/4"-16 UNF	33,5	17,5	11,2	24	24	16,36 x 2,20	GE-S-12-3/4"-UNF-SC	27,34
S	630	12	7/8"-14 UNF	32,5	14,8	12,7	27	24	19,18 x 2,46	GE-S-12-7/8"-UNF-SC	28,04
S	630	14	9/16"-18 UNF	37,0	19,0	10,0	24	27	11,90 x 1,98	GE-S-14-9/16"-UNF-SC	*
S	630	14	3/4"-16 UNF	37,0	19,0	11,2	24	27	16,36 x 2,20	GE-S-14-3/4"-UNF-SC	*
S	400	16	3/4"-16 UNF	37,0	18,5	11,2	27	30	16,36 x 2,20	GE-S-16-3/4"-UNF-SC	31,82
S	400	16	7/8"-14 UNF	33,5	15,5	14,0	30	30	19,18 x 2,46	GE-S-16-7/8"-UNF-SC	33,62
S	400	16	1 1/16"-12 UN	37,0	18,5	15,0	32	30	23,47 x 2,95	GE-S-16-1 1/16"-UN-SC	*
S	400	20	3/4"-16 UNF	42,0	20,5	11,2	32	36	16,36 x 2,20	GE-S-20-3/4"-UNF-SC	48,56
S	400	20	7/8"-14 UNF	42,0	20,5	12,7	32	36	19,18 x 2,46	GE-S-20-7/8"-UNF-SC	48,56
S	400	20	1 1/16"-12 UN	42,0	20,5	15,0	32	36	23,47 x 2,95	GE-S-20-1 1/16"-UN-SC	48,56
S	400	20	1 5/16"-12 UN		22,5	15,0	41	36	29,74 x 2,95	GE-S-20-1 5/16"-UN-SC	74,03
S	400	25	1 1/16"-12 UN	47,0	23,0	15,0	41	46	23,47 x 2,95	GE-S-25-1 1/16"-UN-SC	75,57
S	400	25	1 5/16"-12 UN	47,0	23,0	15,0	41	46	29,74 x 2,95	GE-S-25-1 5/16"-UN-SC	75,57
S	400	30	1 1/16"-12 UN	50,0	23,5	15,0	46	50	23,47 x 2,95	GE-S-30-1 1/16"-UN-SC	179,04
S	400	30	1 5/16"-12 UN	50,0	23,5	15,0	46	50	29,74 x 2,95	GE-S-30-1 5/16"-UN-SC	155,60
S	400	30	1 5/8"-12 UN	50,0	23,5	15,0	50	50	37,46 x 3,00	GE-S-30-1 5/8"-UN-SC	155,60
S	315	38	1 5/8"-12 UN	57,0	26,0	15,0	55	60	37,46 x 3,00	GE-S-38-1 5/8"-UN-SC	206,85
S	315	38	1 7/8"-12 UN	57,0	26,0	15,0	55	60	43,69 x 3,00	GE-S-38-1 7/8"-UN-SC	206,85



**Gerade Einschraubverschraubungsstutzen
S-Reihe**

Einschraubgewinde: UNF (ASA B 1.1 - 1960)

Abdichtung durch Runddichtring (O-Ring) - SAE J 514

Achtung: Spezielle Gewindeausenkung erforderlich.

Andere Sprunggrößen auf Anfrage!

Male Stud Coupling Bodies

S-Series

Thread: UNF (ASA B 1.1 -1960)

Sealing by O-ring in Thread Undercut - SAE J 514

Note: A special part shape must be machined.

Other jump sizes on request!

Reihe Series	Druck Pressure PN	Rohr A.D. Tube O.D. D1	Gewinde Thread G	Ca. Maße Approx. Dimensions				O-Ring O-ring	Bestellzeichen Order-Code OMD	Brutto-Preis Gross-Price Euro (€)
S	630	6	7/16"-20 UNF					8,92 x 1,83	GE-S-06-7/16"-UNF-OMD	20,40
S	630	6	9/16"-18 UNF					11,90 x 1,98	GE-S-06-9/16"-UNF-OMD	21,11
S	630	8	7/16"-20 UNF					8,92 x 1,83	GE-S-08-7/16"-UNF-OMD	20,40
S	630	8	1/2"-20 UNF					10,52 x 1,83	GE-S-08-1/2"-UNF-OMD	20,40
S	630	8	9/16"-18 UNF					11,90 x 1,98	GE-S-08-9/16"-UNF-OMD	20,40
S	630	10	9/16"-18 UNF					11,90 x 1,98	GE-S-10-9/16"-UNF-OMD	20,40
S	630	10	3/4"-16 UNF					16,36 x 2,20	GE-S-10-3/4"-UNF-OMD	22,05
S	630	12	9/16"-18 UNF					11,90 x 1,98	GE-S-12-9/16"-UNF-OMD	21,95
S	630	12	3/4"-16 UNF					16,36 x 2,20	GE-S-12-3/4"-UNF-OMD	22,05
S	630	12	7/8"-14 UNF					19,18 x 2,46	GE-S-12-7/8"-UNF-OMD	22,75
S	630	14	9/16"-18 UNF					11,90 x 1,98	GE-S-14-9/16"-UNF-OMD	*
S	630	14	3/4"-16 UNF					16,36 x 2,20	GE-S-14-3/4"-UNF-OMD	24,76
S	400	16	3/4"-16 UNF					16,36 x 2,20	GE-S-16-3/4"-UNF-OMD	22,05
S	400	16	7/8"-14 UNF					19,18 x 2,46	GE-S-16-7/8"-UNF-OMD	23,85
S	400	16	1 1/16"-12 UN					23,47 x 2,95	GE-S-16-1 1/16"-UN-OMD	36,10
S	400	20	3/4"-16 UNF					16,36 x 2,20	GE-S-20-3/4"-UNF-OMD	36,10
S	400	20	7/8"-14 UNF					19,18 x 2,46	GE-S-20-7/8"-UNF-OMD	36,10
S	400	20	1 1/16"-12 UN					23,47 x 2,95	GE-S-20-1 1/16"-UN-OMD	36,10
S	400	20	1 5/16"-12 UN					29,74 x 2,95	GE-S-20-1 5/16"-UN-OMD	63,45
S	400	25	1 1/16"-12 UN					23,47 x 2,95	GE-S-25-1 1/16"-UN-OMD	53,95
S	400	25	1 5/16"-12 UN					29,74 x 2,95	GE-S-25-1 5/16"-UN-OMD	53,95
S	400	30	1 1/16"-12 UN					23,47 x 2,95	GE-S-30-1 1/16"-UN-OMD	160,03
S	400	30	1 5/16"-12 UN					29,74 x 2,95	GE-S-30-1 5/16"-UN-OMD	128,00
S	400	30	1 5/8"-12 UN					37,46 x 3,00	GE-S-30-1 5/8"-UN-OMD	128,00
S	315	38	1 5/8"-12 UN					37,46 x 3,00	GE-S-38-1 5/8"-UN-OMD	169,40
S	315	38	1 7/8"-12 UN					43,69 x 3,00	GE-S-38-1 7/8"-UN-OMD	169,40

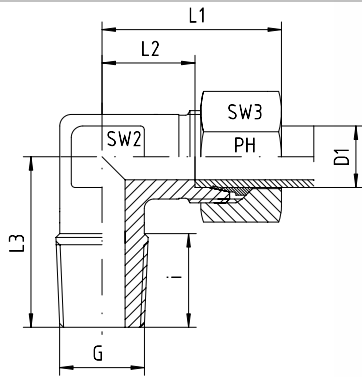

Winkel-Einschraubverschraubungen
LL- und L-Reihe
Einschraubgewinde: Whitworth-Rohrgewinde - Kegelig

Stud Elbows
LL- and L-Series
Thread: BSP - Taper

Reihe Series	Druck Pressure PN	Rohr A.D. Tube O.D. D1	Gewinde Thread G	Ca. Maße Approx. Dimensions						Bestellzeichen Order-Code Standard	Brutto-Preis Gross-Price Euro (€)
				L1	L2	L3	i	SW2	SW3		
LL	100	4	R 1/8" keg	21,0	11,0	17	8	9	10	WE-LL-04-R 1/8"-k	14,93
LL	100	6	R 1/8" keg	21,0	9,5	17	8	9	12	WE-LL-06-R 1/8"-k	15,31
LL	100	8	R 1/8" keg	23,0	11,5	20	8	12	14	WE-LL-08-R 1/8"-k	15,77

Reihe Series	Druck Pressure PN	Rohr A.D. Tube O.D. D1	Gewinde Thread G	Ca. Maße Approx. Dimensions						Bestellzeichen Order-Code Standard	Brutto-Preis Gross-Price Euro (€)
				L1	L2	L3	i	SW2	SW3		
L	315	6	R 1/8" keg	27,0	12,0	20	8	12	14	WE-L-06-R 1/8"-k	10,99
L	315	6	R 1/4" keg	27,0	12,0	26	12	12	14	WE-L-06-R 1/4"-k	14,01
L	315	6	R 3/8" keg	30,0	15,0	27	12	14	14	WE-L-06-R 3/8"-k	17,54
L	315	6	R 1/2" keg	30,5	15,5	30	14	17	14	WE-L-06-R 1/2"-k	23,78
L	315	8	R 1/8" keg	29,0	14,0	26	8	12	17	WE-L-08-R 1/8"-k	17,57
L	315	8	R 1/4" keg	29,0	14,0	26	12	12	17	WE-L-08-R 1/4"-k	13,81
L	315	8	R 3/8" keg	32,0	17,0	28	12	14	17	WE-L-08-R 3/8"-k	16,62
L	315	8	R 1/2" keg	34,5	19,5	30	14	17	17	WE-L-08-R 1/2"-k	23,83
L	315	10	R 1/8" keg	31,5	15,0	27	8	14	19	WE-L-10-R 1/8"-k	18,10
L	315	10	R 1/4" keg	30,0	15,0	27	12	14	19	WE-L-10-R 1/4"-k	15,13
L	315	10	R 3/8" keg	30,0	15,0	28	12	14	19	WE-L-10-R 3/8"-k	17,87
L	315	10	R 1/2" keg	37,0	21,0	33	14	17	19	WE-L-10-R 1/2"-k	24,08
L	315	12	R 1/8" keg	32,0	17,5	27	8	17	22	WE-L-12-R 1/8"-k	18,30
L	315	12	R 1/4" keg	32,0	17,5	27	12	17	22	WE-L-12-R 1/4"-k	17,49
L	315	12	R 3/8" keg	32,0	17,5	28	12	17	22	WE-L-12-R 3/8"-k	16,92
L	315	12	R 1/2" keg	32,0	17,5	34	14	17	22	WE-L-12-R 1/2"-k	24,54
L	315	15	R 1/4" keg	36,0	21,0	32	12	19	27	WE-L-15-R 1/4"-k	27,55
L	315	15	R 3/8" keg	36,0	21,0		12	19	27	WE-L-15-R 3/8"-k	27,05
L	315	15	R 1/2" keg	36,0	21,0	34	14	19	27	WE-L-15-R 1/2"-k	23,01
L	160	15	R 3/4" keg				16	24	27	WE-L-15-R 3/4"-k	43,60
L	315	18	R 3/8" keg	40,0	23,5		12	24	32	WE-L-18-R 3/8"-k	33,05
L	315	18	R 1/2" keg	40,0	23,5	36	14	24	32	WE-L-18-R 1/2"-k	32,29
L	160	18	R 3/4" keg	38,5	22,0	41	16	24	32	WE-L-18-R 3/4"-k	51,14
L	160	22	R 1/2" keg	44,0	27,5	41	14	27	36	WE-L-22-R 1/2"-k	51,64
L	160	22	R 3/4" keg	44,0	27,5	41	16	27	36	WE-L-22-R 3/4"-k	51,64
L	160	28	R 1" keg	51,5	30,5	47	20	36	41	WE-L-28-R 1"-k	97,15
L	160	35	R 1 1/4" keg	59,5	33,0	56	26	41	50	WE-L-35-R 1 1/4"-k	150,83

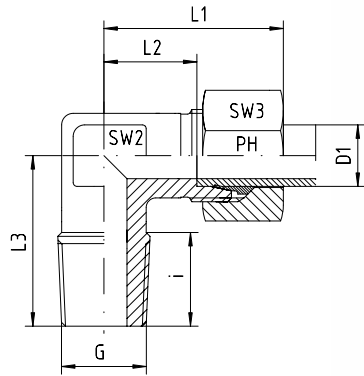

Winkel-Einschraubverschraubungen
L-Reihe
Einschraubgewinde: Whitworth-Rohrgewinde - Kegelig

Stud Elbows
L-Series
Thread: BSP - Taper

Reihe Series	Druck Pressure PN	Rohr A.D. Tube O.D. D1	Gewinde Thread G	Ca. Maße Approx. Dimensions						Bestellzeichen Order-Code SC	Brutto-Preis Gross-Price Euro (€)
				L1	L2	L3	i	SW2	SW3		
L	315	6	R 1/8" keg	27,0	12,0	20	8	12	14	WE-L-06-R 1/8"-k-SC	11,31
L	315	6	R 1/4" keg	27,0	12,0	26	12	12	14	WE-L-06-R 1/4"-k-SC	14,33
L	315	6	R 3/8" keg	30,0	15,0	27	12	14	14	WE-L-06-R 3/8"-k-SC	17,86
L	315	6	R 1/2" keg	30,5	15,5	30	14	17	14	WE-L-06-R 1/2"-k-SC	24,10
L	315	8	R 1/8" keg	29,0	14,0	26	8	12	17	WE-L-08-R 1/8"-k-SC	18,01
L	315	8	R 1/4" keg	29,0	14,0	26	12	12	17	WE-L-08-R 1/4"-k-SC	14,25
L	315	8	R 3/8" keg	32,0	17,0	28	12	14	17	WE-L-08-R 3/8"-k-SC	17,06
L	315	8	R 1/2" keg	34,5	19,5	30	14	17	17	WE-L-08-R 1/2"-k-SC	24,27
L	315	10	R 1/8" keg	31,5	15,0	27	8	14	19	WE-L-10-R 1/8"-k-SC	18,54
L	315	10	R 1/4" keg	30,0	15,0	27	12	14	19	WE-L-10-R 1/4"-k-SC	15,57
L	315	10	R 3/8" keg	30,0	15,0	28	12	14	19	WE-L-10-R 3/8"-k-SC	18,31
L	315	10	R 1/2" keg	37,0	21,0	33	14	17	19	WE-L-10-R 1/2"-k-SC	24,52
L	315	12	R 1/8" keg	32,0	17,5	27	8	17	22	WE-L-12-R 1/8"-k-SC	18,86
L	315	12	R 1/4" keg	32,0	17,5	27	12	17	22	WE-L-12-R 1/4"-k-SC	18,05
L	315	12	R 3/8" keg	32,0	17,5	28	12	17	22	WE-L-12-R 3/8"-k-SC	17,48
L	315	12	R 1/2" keg	32,0	17,5	34	14	17	22	WE-L-12-R 1/2"-k-SC	25,10
L	315	15	R 1/4" keg	36,0	21,0	32	12	19	27	WE-L-15-R 1/4"-k-SC	28,63
L	315	15	R 3/8" keg	36,0	21,0		12	19	27	WE-L-15-R 3/8"-k-SC	28,13
L	315	15	R 1/2" keg	36,0	21,0	34	14	19	27	WE-L-15-R 1/2"-k-SC	24,09
L	160	15	R 3/4" keg				16	24	27	WE-L-15-R 3/4"-k-SC	44,68
L	315	18	R 3/8" keg	40,0	23,5		12	24	32	WE-L-18-R 3/8"-k-SC	34,69
L	315	18	R 1/2" keg	40,0	23,5	36	14	24	32	WE-L-18-R 1/2"-k-SC	33,93
L	160	18	R 3/4" keg	38,5	22,0	41	16	24	32	WE-L-18-R 3/4"-k-SC	52,78
L	160	22	R 1/2" keg	44,0	27,5	41	14	27	36	WE-L-22-R 1/2"-k-SC	53,40
L	160	22	R 3/4" keg	44,0	27,5	41	16	27	36	WE-L-22-R 3/4"-k-SC	53,40
L	160	28	R 1" keg	51,5	30,5	47	20	36	41	WE-L-28-R 1"-k-SC	99,15
L	160	35	R 1 1/4" keg	59,5	33,0	56	26	41	50	WE-L-35-R 1 1/4"-k-SC	154,55



Winkel-Einschraubverschraubungsstutzen
LL- und L-Reihe
Einschraubgewinde: Whitworth-Rohrgewinde - Kegelig

Stud Elbow Bodies
LL- and L-Series
Thread: BSP - Taper

Reihe Series	Druck Pressure PN	Rohr A.D. Tube O.D. D1	Gewinde Thread G	Ca. Maße Approx. Dimensions					Bestellzeichen Order-Code OMD	Brutto-Preis Gross-Price Euro (€)
LL	100	4	R 1/8" keg						WE-LL-04-R 1/8"-k-OMD	12,27
LL	100	6	R 1/8" keg						WE-LL-06-R 1/8"-k-OMD	12,27
LL	100	8	R 1/8" keg						WE-LL-08-R 1/8"-k-OMD	12,27

Reihe Series	Druck Pressure PN	Rohr A.D. Tube O.D. D1	Gewinde Thread G	Ca. Maße Approx. Dimensions					Bestellzeichen Order-Code OMD	Brutto-Preis Gross-Price Euro (€)
L	315	6	R 1/8" keg						WE-L-06-R 1/8"-k-OMD	8,68
L	315	6	R 1/4" keg						WE-L-06-R 1/4"-k-OMD	11,70
L	315	6	R 3/8" keg						WE-L-06-R 3/8"-k-OMD	15,23
L	315	6	R 1/2" keg						WE-L-06-R 1/2"-k-OMD	21,47
L	315	8	R 1/8" keg						WE-L-08-R 1/8"-k-OMD	14,77
L	315	8	R 1/4" keg						WE-L-08-R 1/4"-k-OMD	11,01
L	315	8	R 3/8" keg						WE-L-08-R 3/8"-k-OMD	13,82
L	315	8	R 1/2" keg						WE-L-08-R 1/2"-k-OMD	21,03
L	315	10	R 1/8" keg						WE-L-10-R 1/8"-k-OMD	14,74
L	315	10	R 1/4" keg						WE-L-10-R 1/4"-k-OMD	11,77
L	315	10	R 3/8" keg						WE-L-10-R 3/8"-k-OMD	14,51
L	315	10	R 1/2" keg						WE-L-10-R 1/2"-k-OMD	20,72
L	315	12	R 1/8" keg						WE-L-12-R 1/8"-k-OMD	14,41
L	315	12	R 1/4" keg						WE-L-12-R 1/4"-k-OMD	13,60
L	315	12	R 3/8" keg						WE-L-12-R 3/8"-k-OMD	13,03
L	315	12	R 1/2" keg						WE-L-12-R 1/2"-k-OMD	20,65
L	315	15	R 1/4" keg						WE-L-15-R 1/4"-k-OMD	22,41
L	315	15	R 3/8" keg						WE-L-15-R 3/8"-k-OMD	21,91
L	315	15	R 1/2" keg						WE-L-15-R 1/2"-k-OMD	17,87
L	160	15	R 3/4" keg						WE-L-15-R 3/4"-k-OMD	42,52
L	315	18	R 3/8" keg						WE-L-18-R 3/8"-k-OMD	24,43
L	315	18	R 1/2" keg						WE-L-18-R 1/2"-k-OMD	23,67
L	160	18	R 3/4" keg						WE-L-18-R 3/4"-k-OMD	42,52
L	160	22	R 1/2" keg						WE-L-22-R 1/2"-k-OMD	41,33
L	160	22	R 3/4" keg						WE-L-22-R 3/4"-k-OMD	41,33
L	160	28	R 1" keg						WE-L-28-R 1"-k-OMD	82,30
L	160	35	R 1 1/4" keg						WE-L-35-R 1 1/4"-k-OMD	129,72

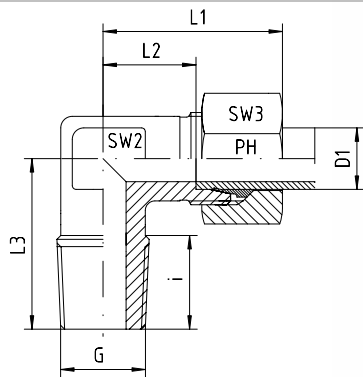

Winkel-Einschraubverschraubungen
S-Reihe
Einschraubgewinde: Whitworth-Rohrgewinde - Kegelig

Stud Elbows
S-Series
Thread: BSP - Taper

Reihe Series	Druck Pressure PN ⁽¹⁾	Rohr A.D. Tube O.D. D1	Gewinde Thread G	Ca. Maße Approx. Dimensions						Bestellzeichen Order-Code Standard	Brutto-Preis Gross-Price Euro (€)
				L1	L2	L3	i	SW2	SW3		
S	630	6	R 1/8" keg	29,5	15,0	25	8	12	17	WE-S-06-R 1/8"-k	16,48
S	630	6	R 1/4" keg	31,0	16,5	26	12	12	17	WE-S-06-R 1/4"-k	14,57
S	630	6	R 3/8" keg	32,0	17,5	27	12	14	17	WE-S-06-R 3/8"-k	18,13
S	630	6	R 1/2" keg	34,0	19,0	33	14	17	17	WE-S-06-R 1/2"-k	26,59
S	630	8	R 1/8" keg				8	14	19	WE-S-08-R 1/8"-k	*
S	630	8	R 1/4" keg	32,0	17,0	27	12	14	19	WE-S-08-R 1/4"-k	17,74
S	630	8	R 3/8" keg	33,0	18,0	28	12	14	19	WE-S-08-R 3/8"-k	17,84
S	630	8	R 1/2" keg	38,0	23,0	33	14	17	19	WE-S-08-R 1/2"-k	25,05
S	630	10	R 1/8" keg				8	17	22	WE-S-10-R 1/8"-k	*
S	630	10	R 1/4" keg	34,0	17,5	28	12	17	22	WE-S-10-R 1/4"-k	18,46
S	630	10	R 3/8" keg	34,0	17,5	28	12	17	22	WE-S-10-R 3/8"-k	17,03
S	630	10	R 1/2" keg	39,0	22,5	32	14	17	22	WE-S-10-R 1/2"-k	25,31
S	630	12	R 1/4" keg	38,0	21,5	27	12	17	24	WE-S-12-R 1/4"-k	26,13
S	630	12	R 3/8" keg	38,0	21,5	28	12	17	24	WE-S-12-R 3/8"-k	20,45
S	630	12	R 1/2" keg	39,0	22,5	32	14	17	24	WE-S-12-R 1/2"-k	25,56
S	630	14	R 3/8" keg	40,0	22,0	30	12	19	27	WE-S-14-R 3/8"-k	27,71
S	630	14	R 1/2" keg	40,0	22,0	32	14	19	27	WE-S-14-R 1/2"-k	28,07
S	400	16	R 3/8" keg	43,0	24,5	32	12	24	30	WE-S-16-R 3/8"-k	41,35
S	400	16	R 1/2" keg	43,0	24,5	32	14	24	30	WE-S-16-R 1/2"-k	40,73
S	160	16	R 3/4" keg	43,0	24,5	41	16	24	30	WE-S-16-R 3/4"-k	50,73
S	400	20	R 1/2" keg	48,0	26,5	42	14	27	36	WE-S-20-R 1/2"-k	53,53
S	400	20	R 3/4" keg	48,0	26,5	42	16	27	36	WE-S-20-R 3/4"-k	53,53

⁽¹⁾ Die angegebenen Druckstufen sind nur gültig, wenn die Einschraublöcher mit kegeligem Gewinde vorhanden sind.

⁽¹⁾ The pressure rates are only valid, if the female parts are with tapered threads, too.

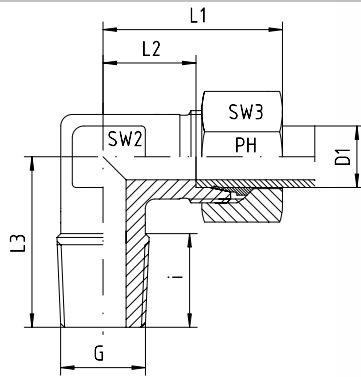

Winkel-Einschraubverschraubungen
S-Reihe
Einschraubgewinde: Whitworth-Rohrgewinde - Kegelig

Stud Elbows
S-Series
Thread: BSP - Taper

Reihe Series	Druck Pressure PN ⁽¹⁾	Rohr A.D. Tube O.D. D1	Gewinde Thread G	Ca. Maße Approx. Dimensions						Bestellzeichen Order-Code SC	Brutto-Preis Gross-Price Euro (€)
				L1	L2	L3	i	SW2	SW3		
S	630	6	R 1/8" keg	29,5	15,0	25	8	12	17	WE-S-06-R 1/8"-k-SC	16,92
S	630	6	R 1/4" keg	31,0	16,5	26	12	12	17	WE-S-06-R 1/4"-k-SC	15,01
S	630	6	R 3/8" keg	32,0	17,5	27	12	14	17	WE-S-06-R 3/8"-k-SC	18,57
S	630	6	R 1/2" keg	34,0	19,0	33	14	17	17	WE-S-06-R 1/2"-k-SC	27,03
S	630	8	R 1/8" keg				8	14	19	WE-S-08-R 1/8"-k-SC	*
S	630	8	R 1/4" keg	32,0	17,0	27	12	14	19	WE-S-08-R 1/4"-k-SC	18,18
S	630	8	R 3/8" keg	33,0	18,0	28	12	14	19	WE-S-08-R 3/8"-k-SC	18,28
S	630	8	R 1/2" keg	38,0	23,0	33	14	17	19	WE-S-08-R 1/2"-k-SC	25,49
S	630	10	R 1/8" keg				8	17	22	WE-S-10-R 1/8"-k-SC	*
S	630	10	R 1/4" keg	34,0	17,5	28	12	17	22	WE-S-10-R 1/4"-k-SC	19,02
S	630	10	R 3/8" keg	34,0	17,5	28	12	17	22	WE-S-10-R 3/8"-k-SC	17,59
S	630	10	R 1/2" keg	39,0	22,5	32	14	17	22	WE-S-10-R 1/2"-k-SC	25,87
S	630	12	R 1/4" keg	38,0	21,5	27	12	17	24	WE-S-12-R 1/4"-k-SC	26,97
S	630	12	R 3/8" keg	38,0	21,5	28	12	17	24	WE-S-12-R 3/8"-k-SC	21,29
S	630	12	R 1/2" keg	39,0	22,5	32	14	17	24	WE-S-12-R 1/2"-k-SC	26,40
S	630	14	R 3/8" keg	40,0	22,0	30	12	19	27	WE-S-14-R 3/8"-k-SC	29,27
S	630	14	R 1/2" keg	40,0	22,0	32	14	19	27	WE-S-14-R 1/2"-k-SC	29,63
S	400	16	R 3/8" keg	43,0	24,5	32	12	24	30	WE-S-16-R 3/8"-k-SC	42,91
S	400	16	R 1/2" keg	43,0	24,5	32	14	24	30	WE-S-16-R 1/2"-k-SC	42,29
S	160	16	R 3/4" keg	43,0	24,5	41	16	24	30	WE-S-16-R 3/4"-k-SC	52,29
S	400	20	R 1/2" keg	48,0	26,5	42	14	27	36	WE-S-20-R 1/2"-k-SC	55,41
S	400	20	R 3/4" keg	48,0	26,5	42	16	27	36	WE-S-20-R 3/4"-k-SC	55,41

⁽¹⁾ Die angegebenen Druckstufen sind nur gültig, wenn die Einschraublöcher mit kegeligem Gewinde vorhanden sind.

⁽¹⁾ The pressure rates are only valid, if the female parts are with tapered threads, too.



Winkel-Einschraubverschraubungsstutzen
S-Reihe

Einschraubgewinde: Whitworth-Rohrgewinde - Kegelig

Stud Elbow Bodies

S-Series

Thread: BSP - Taper

Reihe Series	Druck Pressure PN ⁽¹⁾	Rohr A.D. Tube O.D. D1	Gewinde Thread G	Ca. Maße Approx. Dimensions						Bestellzeichen Order-Code OMD	Brutto-Preis Gross-Price Euro (€)
S	630	6	R 1/8" keg							WE-S-06-R 1/8"-k-OMD	13,70
S	630	6	R 1/4" keg							WE-S-06-R 1/4"-k-OMD	11,78
S	630	6	R 3/8" keg							WE-S-06-R 3/8"-k-OMD	15,34
S	630	6	R 1/2" keg							WE-S-06-R 1/2"-k-OMD	23,80
S	630	8	R 1/8" keg							WE-S-08-R 1/8"-k-OMD	*
S	630	8	R 1/4" keg							WE-S-08-R 1/4"-k-OMD	14,54
S	630	8	R 3/8" keg							WE-S-08-R 3/8"-k-OMD	14,64
S	630	8	R 1/2" keg							WE-S-08-R 1/2"-k-OMD	21,85
S	630	10	R 1/8" keg							WE-S-10-R 1/8"-k-OMD	*
S	630	10	R 1/4" keg							WE-S-10-R 1/4"-k-OMD	14,52
S	630	10	R 3/8" keg							WE-S-10-R 3/8"-k-OMD	13,09
S	630	10	R 1/2" keg							WE-S-10-R 1/2"-k-OMD	21,37
S	630	12	R 1/4" keg							WE-S-12-R 1/4"-k-OMD	21,68
S	630	12	R 3/8" keg							WE-S-12-R 3/8"-k-OMD	16,00
S	630	12	R 1/2" keg							WE-S-12-R 1/2"-k-OMD	21,11
S	630	14	R 3/8" keg							WE-S-14-R 3/8"-k-OMD	22,21
S	630	14	R 1/2" keg							WE-S-14-R 1/2"-k-OMD	22,57
S	400	16	R 3/8" keg							WE-S-16-R 3/8"-k-OMD	33,14
S	400	16	R 1/2" keg							WE-S-16-R 1/2"-k-OMD	32,52
S	160	16	R 3/4" keg							WE-S-16-R 3/4"-k-OMD	42,52
S	400	20	R 1/2" keg							WE-S-20-R 1/2"-k-OMD	42,95
S	400	20	R 3/4" keg							WE-S-20-R 3/4"-k-OMD	42,95

⁽¹⁾ Die angegebenen Druckstufen sind nur gültig, wenn die Einschraublöcher mit kegeligem Gewinde vorhanden sind.

⁽¹⁾ The pressure rates are only valid, if the female parts are with tapered threads, too.



Winkel-Einschraubverschraubungen
L- und S-Reihe
Einschraubgewinde: Whitworth-Rohrgewinde - Zylindrisch
Abdichtung durch Dichtkante Form B

Stud Elbows
L- and S-Series
Thread: BSP - Parallel
Sealing by Sealing Shoulder Form B

Reihe Series	Druck Pressure PN	Rohr A.D. Tube O.D. D1	Gewinde Thread G	Ca. Maße Approx. Dimensions						Bestellzeichen Order-Code Standard	Brutto-Preis Gross-Price Euro (€)
				L1	L2	L3	i	SW2	SW3		
L	160	22	G 3/4" zyl	44	27,5	26	16	27	36	WE-L-22-G 3/4"-z	43,59
L	160	28	G 1" zyl	47	30,5	30	18	36	41	WE-L-28-G 1"-z	89,48
L	160	35	G 1 1/4" zyl	56	34,5	34	20	41	50	WE-L-35-G 1 1/4"-z	148,28
L	160	42	G 1 1/2" zyl	63	40,0	39	22	50	60	WE-L-42-G 1 1/2"-z	196,85

Reihe Series	Druck Pressure PN	Rohr A.D. Tube O.D. D1	Gewinde Thread G	Ca. Maße Approx. Dimensions						Bestellzeichen Order-Code Standard	Brutto-Preis Gross-Price Euro (€)
				L1	L2	L3	i	SW2	SW3		
S	400	20	G 3/4" zyl	48	26,5	26	16	27	36	WE-S-20-G 3/4"-z	45,68
S	250	25	G 1" zyl	54	30,0	30	18	36	46	WE-S-25-G 1"-z	99,70
S	160	30	G 1 1/4" zyl	62	35,5	34	20	41	50	WE-S-30-G 1 1/4"-z	148,28
S	160	38	G 1 1/2" zyl	72	41,0	39	22	50	60	WE-S-38-G 1 1/2"-z	204,52



Winkel-Einschraubverschraubungen
L- und S-Reihe
Einschraubgewinde: Whitworth-Rohrgewinde - Zylindrisch
Abdichtung durch Dichtkante Form B

Stud Elbows
L- and S-Series
Thread: BSP - Parallel
Sealing by Sealing Shoulder Form B

Reihe Series	Druck Pressure PN	Rohr A.D. Tube O.D. D1	Gewinde Thread G	Ca. Maße Approx. Dimensions						Bestellzeichen Order-Code SC	Brutto-Preis Gross-Price Euro (€)
				L1	L2	L3	i	SW2	SW3		
L	160	22	G 3/4" zyl	44	27,5	26	16	27	36	WE-L-22-G 3/4"-z-SC	45,35
L	160	28	G 1" zyl	47	30,5	30	18	36	41	WE-L-28-G 1"-z-SC	91,48
L	160	35	G 1 1/4" zyl	56	34,5	34	20	41	50	WE-L-35-G 1 1/4"-z-SC	152,00
L	160	42	G 1 1/2" zyl	63	40,0	39	22	50	60	WE-L-42-G 1 1/2"-z-SC	201,17

Reihe Series	Druck Pressure PN	Rohr A.D. Tube O.D. D1	Gewinde Thread G	Ca. Maße Approx. Dimensions						Bestellzeichen Order-Code SC	Brutto-Preis Gross-Price Euro (€)
				L1	L2	L3	i	SW2	SW3		
S	400	20	G 3/4" zyl	48	26,5	26	16	27	36	WE-S-20-G 3/4"-z-SC	47,56
S	250	25	G 1" zyl	54	30,0	30	18	36	46	WE-S-25-G 1"-z-SC	102,70
S	160	30	G 1 1/4" zyl	62	35,5	34	20	41	50	WE-S-30-G 1 1/4"-z-SC	152,44
S	160	38	G 1 1/2" zyl	72	41,0	39	22	50	60	WE-S-38-G 1 1/2"-z-SC	210,16



Winkel-Einschraubverschraubungsstutzen

L- und S-Reihe

Einschraubgewinde: Whitworth-Rohrgewinde - Zylindrisch
Abdichtung durch Dichtkante Form B

Stud Elbow Bodies

L- and S-Series

Thread: BSP - Parallel

Sealing by Sealing Shoulder Form B

Reihe Series	Druck Pressure PN	Rohr A.D. Tube O.D. D1	Gewinde Thread G	Ca. Maße Approx. Dimensions					Bestellzeichen Order-Code OMD	Brutto-Preis Gross-Price Euro (€)
L	160	22	G 3/4" zyl						WE-L-22-G 3/4"-z-OMD	33,28
L	160	28	G 1" zyl						WE-L-28-G 1"-z-OMD	74,63
L	160	35	G 1 1/4" zyl						WE-L-35-G 1 1/4"-z-OMD	127,17
L	160	42	G 1 1/2" zyl						WE-L-42-G 1 1/2"-z-OMD	169,42

Reihe Series	Druck Pressure PN	Rohr A.D. Tube O.D. D1	Gewinde Thread G	Ca. Maße Approx. Dimensions					Bestellzeichen Order-Code OMD	Brutto-Preis Gross-Price Euro (€)
S	400	20	G 3/4" zyl						WE-S-20-G 3/4"-z-OMD	35,10
S	250	25	G 1" zyl						WE-S-25-G 1"-z-OMD	81,08
S	160	30	G 1 1/4" zyl						WE-S-30-G 1 1/4"-z-OMD	124,84
S	160	38	G 1 1/2" zyl						WE-S-38-G 1 1/2"-z-OMD	172,71

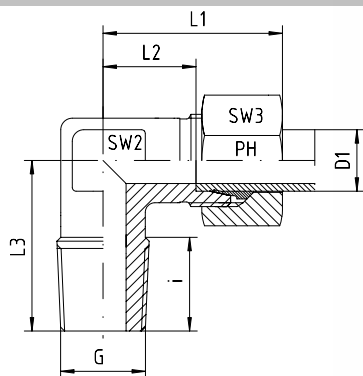

Winkel-Einschraubverschraubungen
LL-, L- und S-Reihe
Einschraubgewinde: Metrisches Feingewinde - Kegelig

Stud Elbows
LL-, L- and S-Series
Thread: Metric - Taper

Reihe Series	Druck Pressure PN	Rohr A.D. Tube O.D. D1	Gewinde Thread G	Ca. Maße Approx. Dimensions						Bestellzeichen Order-Code Standard	Brutto-Preis Gross-Price Euro (€)
				L1	L2	L3	i	SW2	SW3		
LL	100	4	M 6 x 1 keg	21	11,0	17	8	9	10	WE-LL-04-M 6x1-k	16,62
LL	100	4	M 8 x 1 keg	21	11,0	17	8	9	10	WE-LL-04-M 8x1-k	13,81
LL	100	4	M 10 x 1 keg	21	11,0	17	8	9	10	WE-LL-04-M 10x1-k	16,62
LL	100	6	M 6 x 1 keg	23	10,0	17	8	9	12	WE-LL-06-M 6x1-k	17,13
LL	100	6	M 8 x 1 keg	23	10,0	17	8	9	12	WE-LL-06-M 8x1-k	17,13
LL	100	6	M 10 x 1 keg	21	9,5	17	8	9	12	WE-LL-06-M 10x1-k	14,27
LL	100	8	M 6 x 1 keg	23	11,5	20	8	12	14	WE-LL-08-M 6x1-k	17,64
LL	100	8	M 8 x 1 keg	23	11,5	20	8	12	14	WE-LL-08-M 8x1-k	17,64
LL	100	8	M 10 x 1 keg	23	11,5	20	8	12	14	WE-LL-08-M 10x1-k	14,57

Reihe Series	Druck Pressure PN	Rohr A.D. Tube O.D. D1	Gewinde Thread G	Ca. Maße Approx. Dimensions						Bestellzeichen Order-Code Standard	Brutto-Preis Gross-Price Euro (€)
				L1	L2	L3	i	SW2	SW3		
L	315	6	M 10 x 1 keg	27	12,0	20	8	12	14	WE-L-06-M 10x1-k	12,35
L	315	8	M 12 x 1,5 keg	29	14,0	26	12	12	17	WE-L-08-M 12x1,5-k	14,27
L	315	10	M 12 x 1,5 keg	30	15,0	27	12	14	19	WE-L-10-M 12x1,5-k	17,26
L	315	10	M 14 x 1,5 keg	30	15,0	27	12	14	19	WE-L-10-M 14x1,5-k	15,80
L	315	10	M 16 x 1,5 keg	30	15,0	28	12	14	19	WE-L-10-M 16x1,5-k	18,50
L	315	12	M 16 x 1,5 keg	32	17,0	28	12	17	22	WE-L-12-M 16x1,5-k	16,34
L	315	15	M 18 x 1,5 keg	36	21,0	32	12	19	27	WE-L-15-M 18x1,5-k	24,44
L	315	18	M 22 x 1,5 keg	40	23,0	36	14	24	32	WE-L-18-M 22x1,5-k	33,67

Reihe Series	Druck Pressure PN ⁽¹⁾	Rohr A.D. Tube O.D. D1	Gewinde Thread G	Ca. Maße Approx. Dimensions						Bestellzeichen Order-Code Standard	Brutto-Preis Gross-Price Euro (€)
				L1	L2	L3	i	SW2	SW3		
S	630	6	M 12 x 1,5 keg	31	16,0	26	12	12	17	WE-S-06-M 12x1,5-k	15,24
S	630	8	M 14 x 1,5 keg	32	17,0	27	12	14	19	WE-S-08-M 14x1,5-k	17,28
S	630	10	M 16 x 1,5 keg	34	17,5	28	12	17	22	WE-S-10-M 16x1,5-k	20,86
S	630	12	M 18 x 1,5 keg	38	21,5	28	12	17	24	WE-S-12-M 18x1,5-k	26,05
S	630	14	M 20 x 1,5 keg	40	22,0	32	14	19	27	WE-S-14-M 20x1,5-k	31,75
S	630	16	M 22 x 1,5 keg	43	24,5	32	14	24	30	WE-S-16-M 22x1,5-k	40,03

⁽¹⁾ Die angegebenen Druckstufen sind nur gültig, wenn die Einschraublöcher mit kegeligem Gewinde vorhanden sind.

⁽¹⁾ The pressure rates are only valid, if the female parts are with tapered threads, too.

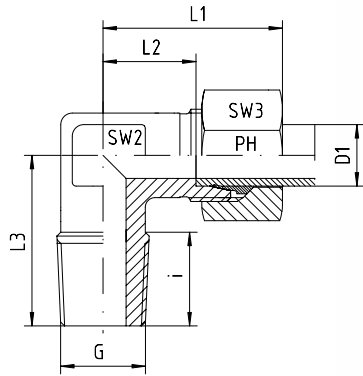

Winkel-Einschraubverschraubungen
L- und S-Reihe
Einschraubgewinde: Metrisches Feingewinde - Kegelig

Stud Elbows
L- and S-Series
Thread: Metric - Taper

Reihe Series	Druck Pressure PN	Rohr A.D. Tube O.D. D1	Gewinde Thread G	Ca. Maße Approx. Dimensions						Bestellzeichen Order-Code SC	Brutto-Preis Gross-Price Euro (€)
				L1	L2	L3	i	SW2	SW3		
L	315	6	M 10 x 1 keg	27	12,0	20	8	12	14	WE-L-06-M 10x1-k-SC	12,67
L	315	8	M 12 x 1,5 keg	29	14,0	26	12	12	17	WE-L-08-M 12x1,5-k-SC	14,71
L	315	10	M 12 x 1,5 keg	30	15,0	27	12	14	19	WE-L-10-M 12x1,5-k-SC	17,70
L	315	10	M 14 x 1,5 keg	30	15,0	27	12	14	19	WE-L-10-M 14x1,5-k-SC	16,24
L	315	12	M 16 x 1,5 keg	32	17,0	28	12	17	22	WE-L-12-M 16x1,5-k-SC	16,90
L	315	15	M 18 x 1,5 keg	36	21,0	32	12	19	27	WE-L-15-M 18x1,5-k-SC	25,52
L	315	18	M 22 x 1,5 keg	40	23,0	36	14	24	32	WE-L-18-M 22x1,5-k-SC	35,31

Reihe Series	Druck Pressure PN ⁽¹⁾	Rohr A.D. Tube O.D. D1	Gewinde Thread G	Ca. Maße Approx. Dimensions						Bestellzeichen Order-Code SC	Brutto-Preis Gross-Price Euro (€)
				L1	L2	L3	i	SW2	SW3		
S	630	6	M 12 x 1,5 keg	31	16,0	26	12	12	17	WE-S-06-M 12x1,5-k-SC	15,68
S	630	8	M 14 x 1,5 keg	32	17,0	27	12	14	19	WE-S-08-M 14x1,5-k-SC	17,72
S	630	10	M 16 x 1,5 keg	34	17,5	28	12	17	22	WE-S-10-M 16x1,5-k-SC	21,42
S	630	12	M 18 x 1,5 keg	38	21,5	28	12	17	24	WE-S-12-M 18x1,5-k-SC	26,89
S	630	14	M 20 x 1,5 keg	40	22,0	32	14	19	27	WE-S-14-M 20x1,5-k-SC	33,31
S	630	16	M 22 x 1,5 keg	43	24,5	32	14	24	30	WE-S-16-M 22x1,5-k-SC	41,59

⁽¹⁾ Die angegebenen Druckstufen sind nur gültig, wenn die Einschraublöcher mit kegeligem Gewinde vorhanden sind.

⁽¹⁾ The pressure rates are only valid, if the female parts are with tapered threads, too.



Winkel-Einschraubverschraubungsstutzen
LL-, L- und S-Reihe
Einschraubgewinde: Metrisches Feingewinde - Kegelig

Stud Elbow Bodies
LL-, L- and S-Series
Thread: Metric - Taper

Reihe Series	Druck Pressure PN	Rohr A.D. Tube O.D. D1	Gewinde Thread G	Ca. Maße Approx. Dimensions					Bestellzeichen Order-Code OMD	Brutto-Preis Gross-Price Euro (€)
LL	100	4	M 6 x 1 keg						WE-LL-04-M 6x1-k-OMD	13,96
LL	100	4	M 8 x 1 keg						WE-LL-04-M 8x1-k-OMD	11,15
LL	100	4	M 10 x 1 keg						WE-LL-04-M 10x1-k-OMD	13,96
LL	100	6	M 6 x 1 keg						WE-LL-06-M 6x1-k-OMD	14,09
LL	100	6	M 8 x 1 keg						WE-LL-06-M 8x1-k-OMD	14,09
LL	100	6	M 10 x 1 keg						WE-LL-06-M 10x1-k-OMD	11,23
LL	100	8	M 6 x 1 keg						WE-LL-08-M 6x1-k-OMD	14,14
LL	100	8	M 8 x 1 keg						WE-LL-08-M 8x1-k-OMD	14,14
LL	100	8	M 10 x 1 keg						WE-LL-08-M 10x1-k-OMD	11,07

Reihe Series	Druck Pressure PN	Rohr A.D. Tube O.D. D1	Gewinde Thread G	Ca. Maße Approx. Dimensions					Bestellzeichen Order-Code OMD	Brutto-Preis Gross-Price Euro (€)
L	315	6	M 10 x 1 keg						WE-L-06-M 10x1-k-OMD	10,04
L	315	8	M 12 x 1,5 keg						WE-L-08-M 12x1,5-k-OMD	11,47
L	315	10	M 12 x 1,5 keg						WE-L-10-M 12x1,5-k-OMD	13,90
L	315	10	M 14 x 1,5 keg						WE-L-10-M 14x1,5-k-OMD	12,44
L	315	12	M 16 x 1,5 keg						WE-L-12-M 16x1,5-k-OMD	12,45
L	315	15	M 18 x 1,5 keg						WE-L-15-M 18x1,5-k-OMD	19,30
L	315	18	M 22 x 1,5 keg						WE-L-18-M 22x1,5-k-OMD	25,05

Reihe Series	Druck Pressure PN ⁽¹⁾	Rohr A.D. Tube O.D. D1	Gewinde Thread G	Ca. Maße Approx. Dimensions					Bestellzeichen Order-Code OMD	Brutto-Preis Gross-Price Euro (€)
S	630	6	M 12 x 1,5 keg						WE-S-06-M 12x1,5-k-OMD	12,45
S	630	8	M 14 x 1,5 keg						WE-S-08-M 14x1,5-k-OMD	14,08
S	630	10	M 16 x 1,5 keg						WE-S-10-M 16x1,5-k-OMD	16,92
S	630	12	M 18 x 1,5 keg						WE-S-12-M 18x1,5-k-OMD	21,60
S	630	14	M 20 x 1,5 keg						WE-S-14-M 20x1,5-k-OMD	26,25
S	630	16	M 22 x 1,5 keg						WE-S-16-M 22x1,5-k-OMD	31,82

⁽¹⁾ Die angegebenen Druckstufen sind nur gültig, wenn die Einschraublöcher mit kegeligem Gewinde vorhanden sind.

⁽¹⁾ The pressure rates are only valid, if the female parts are with tapered threads, too.



Winkel-Einschraubverschraubungen
L- und S-Reihe
Einschraubgewinde: Metrisches Feingewinde - Zylindrisch
Abdichtung durch Dichtkante Form B

Stud Elbows
L- and S-Series
Thread: Metric - Parallel
Sealing by Sealing Shoulder Form B

Reihe Series	Druck Pressure PN	Rohr A.D. Tube O.D. D1	Gewinde Thread G	Ca. Maße Approx. Dimensions						Bestellzeichen Order-Code Standard	Brutto-Preis Gross-Price Euro (€)
				L1	L2	L3	i	SW2	SW3		
L	160	22	M 26 x 1,5 zyl	44	27,5	26	16	27	36	WE-L-22-M 26x1,5-z	48,68
L	160	28	M 33 x 2 zyl	47	30,5	30	18	36	41	WE-L-28-M 33x2-z	101,24
L	160	35	M 42 x 2 zyl	56	34,5	34	20	41	50	WE-L-35-M 42x2-z	170,26
L	160	42	M 48 x 2 zyl	63	40,0	39	22	50	60	WE-L-42-M 48x2-z	208,61

Reihe Series	Druck Pressure PN	Rohr A.D. Tube O.D. D1	Gewinde Thread G	Ca. Maße Approx. Dimensions						Bestellzeichen Order-Code Standard	Brutto-Preis Gross-Price Euro (€)
				L1	L2	L3	i	SW2	SW3		
S	400	20	M 27 x 2 zyl	48	26,5	26	16	27	36	WE-S-20-M 27x2-z	50,77
S	250	25	M 33 x 2 zyl	54	30,0	30	18	36	46	WE-S-25-M 33x2-z	106,35
S	160	30	M 42 x 2 zyl	62	35,5	34	20	41	50	WE-S-30-M 42x2-z	149,04
S	160	38	M 48 x 2 zyl	72	41,0	39	22	50	60	WE-S-38-M 48x2-z	206,05

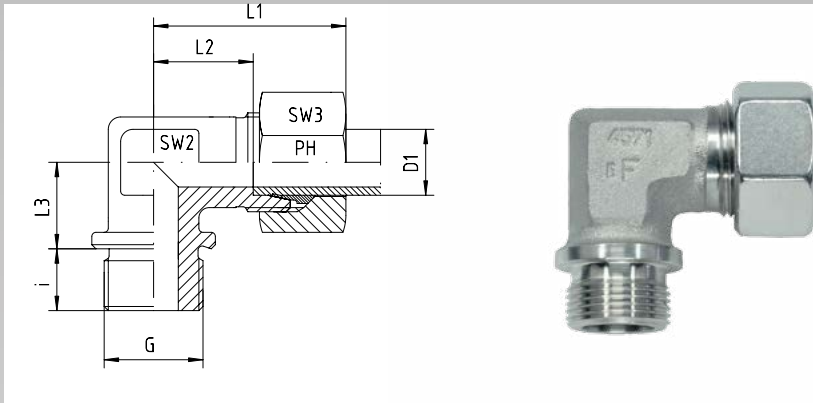

Winkel-Einschraubverschraubungen

L- und S-Reihe

Einschraubgewinde: Metrisches Feingewinde - Zylindrisch
Abdichtung durch Dichtkante Form B

Stud Elbows

L- and S-Series

Thread: Metric - Parallel

Sealing by Sealing Shoulder Form B

Reihe Series	Druck Pressure PN	Rohr A.D. Tube O.D. D1	Gewinde Thread G	Ca. Maße Approx. Dimensions						Bestellzeichen Order-Code SC	Brutto-Preis Gross-Price Euro (€)
				L1	L2	L3	i	SW2	SW3		
L	160	22	M 26 x 1,5 zyl	44	27,5	26	16	27	36	WE-L-22-M 26x1,5-z-SC	50,44
L	160	28	M 33 x 2 zyl	47	30,5	30	18	36	41	WE-L-28-M 33x2-z-SC	103,24
L	160	35	M 42 x 2 zyl	56	34,5	34	20	41	50	WE-L-35-M 42x2-z-SC	173,98
L	160	42	M 48 x 2 zyl	63	40,0	39	22	50	60	WE-L-42-M 48x2-z-SC	212,93

Reihe Series	Druck Pressure PN	Rohr A.D. Tube O.D. D1	Gewinde Thread G	Ca. Maße Approx. Dimensions						Bestellzeichen Order-Code SC	Brutto-Preis Gross-Price Euro (€)
				L1	L2	L3	i	SW2	SW3		
S	400	20	M 27 x 2 zyl	48	26,5	26	16	27	36	WE-S-20-M 27x2-z-SC	52,65
S	250	25	M 33 x 2 zyl	54	30,0	30	18	36	46	WE-S-25-M 33x2-z-SC	109,35
S	160	30	M 42 x 2 zyl	62	35,5	34	20	41	50	WE-S-30-M 42x2-z-SC	153,20
S	160	38	M 48 x 2 zyl	72	41,0	39	22	50	60	WE-S-38-M 48x2-z-SC	211,69



Winkel-Einschraubverschraubungsstutzen

L- und S-Reihe

Einschraubgewinde: Metrisches Feingewinde - Zylindrisch
Abdichtung durch Dichtkante Form B

Stud Elbow Bodies

L- and S-Series

Thread: Metric - Parallel

Sealing by Sealing Shoulder Form B

Reihe Series	Druck Pressure PN	Rohr A.D. Tube O.D. D1	Gewinde Thread G	Ca. Maße Approx. Dimensions					Bestellzeichen Order-Code OMD	Brutto-Preis Gross-Price Euro (€)
L	160	22	M 26 x 1,5 zyl						WE-L-22-M 26x1,5-z-OMD	38,37
L	160	28	M 33 x 2 zyl						WE-L-28-M 33x2-z-OMD	86,39
L	160	35	M 42 x 2 zyl						WE-L-35-M 42x2-z-OMD	149,15
L	160	42	M 48 x 2 zyl						WE-L-42-M 48x2-z-OMD	181,18

Reihe Series	Druck Pressure PN	Rohr A.D. Tube O.D. D1	Gewinde Thread G	Ca. Maße Approx. Dimensions					Bestellzeichen Order-Code OMD	Brutto-Preis Gross-Price Euro (€)
S	400	20	M 27 x 2 zyl						WE-S-20-M 27x2-z-OMD	40,19
S	250	25	M 33 x 2 zyl						WE-S-25-M 33x2-z-OMD	87,73
S	160	30	M 42 x 2 zyl						WE-S-30-M 42x2-z-OMD	125,60
S	160	38	M 48 x 2 zyl						WE-S-38-M 48x2-z-OMD	174,24

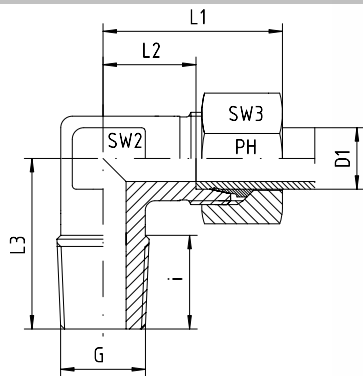

Winkel-Einschraubverschraubungen
LL- und L-Reihe
Einschraubgewinde: NPT

Stud Elbows
LL- and L-Series
Thread: NPT

Reihe Series	Druck Pressure PN	Rohr A.D. Tube O.D. D1	Gewinde Thread G	Ca. Maße Approx. Dimensions						Bestellzeichen Order-Code Standard	Brutto-Preis Gross-Price Euro (€)
				L1	L2	L3	i	SW2	SW3		
LL	100	4	1/8" NPT	21,0	11,0	17	10,0	9	10	WE-LL-04-1/8"-NPT	15,40
LL	100	6	1/8" NPT	21,0	9,5	17	10,0	9	12	WE-LL-06-1/8"-NPT	16,30
LL	100	8	1/8" NPT	23,0	11,5	20	10,0	12	14	WE-LL-08-1/8"-NPT	17,40

Reihe Series	Druck Pressure PN	Rohr A.D. Tube O.D. D1	Gewinde Thread G	Ca. Maße Approx. Dimensions						Bestellzeichen Order-Code Standard	Brutto-Preis Gross-Price Euro (€)
				L1	L2	L3	i	SW2	SW3		
L	315	6	1/8" NPT	27,0	12,0	20	10,0	12	14	WE-L-06-1/8"-NPT	16,51
L	315	6	1/4" NPT	29,0	14,0	26	15,0	12	14	WE-L-06-1/4"-NPT	17,46
L	315	6	3/8" NPT	33,0	18,0	28	15,3	14	14	WE-L-06-3/8"-NPT	23,19
L	315	6	1/2" NPT	30,5	15,5	30	20,0	17	14	WE-L-06-1/2"-NPT	27,07
L	315	8	1/8" NPT	29,0	14,0	26	10,0	12	17	WE-L-08-1/8"-NPT	18,56
L	315	8	1/4" NPT	29,0	14,0	26	15,0	12	17	WE-L-08-1/4"-NPT	19,43
L	315	8	3/8" NPT	29,0	14,0	26	15,3	14	17	WE-L-08-3/8"-NPT	23,67
L	315	8	1/2" NPT	34,5	19,5	30	20,0	17	17	WE-L-08-1/2"-NPT	27,30
L	315	10	1/8" NPT	30,0	15,0	27	10,0	14	19	WE-L-10-1/8"-NPT	23,47
L	315	10	1/4" NPT	30,0	15,0	27	15,0	14	19	WE-L-10-1/4"-NPT	22,60
L	315	10	3/8" NPT	32,0	17,0	28	15,3	14	19	WE-L-10-3/8"-NPT	23,78
L	315	10	1/2" NPT	37,0	21,0	33	20,0	17	19	WE-L-10-1/2"-NPT	26,84
L	315	12	1/8" NPT	32,0	17,0	28	10,0	17	22	WE-L-12-1/8"-NPT	24,90
L	315	12	1/4" NPT	32,0	17,0	28	15,0	17	22	WE-L-12-1/4"-NPT	24,31
L	315	12	3/8" NPT	32,0	17,0	28	15,3	17	22	WE-L-12-3/8"-NPT	24,31
L	315	12	1/2" NPT	36,0	21,0	34	20,0	17	22	WE-L-12-1/2"-NPT	27,07
L	315	15	3/8" NPT	36,0	21,0	34	15,3	19	27	WE-L-15-3/8"-NPT	30,65
L	315	15	1/2" NPT	36,0	21,0	34	20,0	19	27	WE-L-15-1/2"-NPT	30,65
L	160	15	3/4" NPT	36,0	21,0	42	20,0	24	27	WE-L-15-3/4"-NPT	50,14
L	315	18	3/8" NPT	40,0	23,5	36	15,3	24	32	WE-L-18-3/8"-NPT	43,02
L	315	18	1/2" NPT	40,0	23,5	36	20,0	24	32	WE-L-18-1/2"-NPT	41,90
L	160	18	3/4" NPT	38,5	22,0	41	20,0	24	32	WE-L-18-3/4"-NPT	51,14
L	160	22	1/2" NPT	44,0	27,5	42	20,0	27	36	WE-L-22-1/2"-NPT	51,64
L	160	22	3/4" NPT	44,0	27,5	42	20,0	27	36	WE-L-22-3/4"-NPT	51,64
L	160	28	3/4" NPT	47,0	30,5	48	20,0	36	41	WE-L-28-3/4"-NPT	104,75
L	160	28	1" NPT	47,0	30,5	48	25,0	36	41	WE-L-28-1"-NPT	97,15
L	160	35	1 1/4" NPT	56,0	34,5	54	25,5	41	50	WE-L-35-1 1/4"-NPT	150,83
L	160	42	1 1/2" NPT	63,0	40,0	61	26,0	50	60	WE-L-42-1 1/2"-NPT	207,08

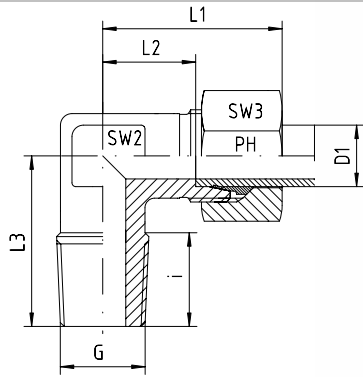

Winkel-Einschraubverschraubungen
L-Reihe
Einschraubgewinde: NPT

Stud Elbows
L-Series
Thread: NPT

Reihe Series	Druck Pressure PN	Rohr A.D. Tube O.D. D1	Gewinde Thread G	Ca. Maße Approx. Dimensions						Bestellzeichen Order-Code SC	Brutto-Preis Gross-Price Euro (€)
				L1	L2	L3	i	SW2	SW3		
L	315	6	1/8" NPT	27,0	12,0	20	10,0	12	14	WE-L-06-1/8"-NPT-SC	16,83
L	315	6	1/4" NPT	29,0	14,0	26	15,0	12	14	WE-L-06-1/4"-NPT-SC	17,78
L	315	6	3/8" NPT	33,0	18,0	28	15,3	14	14	WE-L-06-3/8"-NPT-SC	23,51
L	315	6	1/2" NPT	30,5	15,5	30	20,0	17	14	WE-L-06-1/2"-NPT-SC	27,39
L	315	8	1/8" NPT	29,0	14,0	26	10,0	12	17	WE-L-08-1/8"-NPT-SC	19,00
L	315	8	1/4" NPT	29,0	14,0	26	15,0	12	17	WE-L-08-1/4"-NPT-SC	19,87
L	315	8	3/8" NPT	29,0	14,0	26	15,3	14	17	WE-L-08-3/8"-NPT-SC	24,11
L	315	8	1/2" NPT	34,5	19,5	30	20,0	17	17	WE-L-08-1/2"-NPT-SC	27,74
L	315	10	1/8" NPT	30,0	15,0	27	10,0	14	19	WE-L-10-1/8"-NPT-SC	23,91
L	315	10	1/4" NPT	30,0	15,0	27	15,0	14	19	WE-L-10-1/4"-NPT-SC	23,04
L	315	10	3/8" NPT	32,0	17,0	28	15,3	14	19	WE-L-10-3/8"-NPT-SC	24,22
L	315	10	1/2" NPT	37,0	21,0	33	20,0	17	19	WE-L-10-1/2"-NPT-SC	27,28
L	315	12	1/8" NPT	32,0	17,0	28	10,0	17	22	WE-L-12-1/8"-NPT-SC	25,46
L	315	12	1/4" NPT	32,0	17,0	28	15,0	17	22	WE-L-12-1/4"-NPT-SC	24,87
L	315	12	3/8" NPT	32,0	17,0	28	15,3	17	22	WE-L-12-3/8"-NPT-SC	24,87
L	315	12	1/2" NPT	36,0	21,0	34	20,0	17	22	WE-L-12-1/2"-NPT-SC	27,63
L	315	15	3/8" NPT	36,0	21,0	34	15,3	19	27	WE-L-15-3/8"-NPT-SC	31,73
L	315	15	1/2" NPT	36,0	21,0	34	20,0	19	27	WE-L-15-1/2"-NPT-SC	31,73
L	160	15	3/4" NPT	36,0	21,0	42	20,0	24	27	WE-L-15-3/4"-NPT-SC	51,78
L	315	18	3/8" NPT	40,0	23,5	36	15,3	24	32	WE-L-18-3/8"-NPT-SC	44,66
L	315	18	1/2" NPT	40,0	23,5	36	20,0	24	32	WE-L-18-1/2"-NPT-SC	43,54
L	160	18	3/4" NPT	38,5	22,0	41	20,0	24	32	WE-L-18-3/4"-NPT-SC	52,78
L	160	22	1/2" NPT	44,0	27,5	42	20,0	27	36	WE-L-22-1/2"-NPT-SC	53,40
L	160	22	3/4" NPT	44,0	27,5	42	20,0	27	36	WE-L-22-3/4"-NPT-SC	53,40
L	160	28	3/4" NPT	47,0	30,5	48	20,0	36	41	WE-L-28-3/4"-NPT-SC	106,75
L	160	28	1" NPT	47,0	30,5	48	25,0	36	41	WE-L-28-1"-NPT-SC	99,15
L	160	35	1 1/4" NPT	56,0	34,5	54	25,5	41	50	WE-L-35-1 1/4"-NPT-SC	154,55
L	160	42	1 1/2" NPT	63,0	40,0	61	26,0	50	60	WE-L-42-1 1/2"-NPT-SC	211,40



Winkel-Einschraubverschraubungsstutzen
LL- und L-Reihe
Einschraubgewinde: NPT

Stud Elbow Bodies
LL- and L-Series
Thread: NPT

Reihe Series	Druck Pressure PN	Rohr A.D. Tube O.D. D1	Gewinde Thread G	Ca. Maße Approx. Dimensions					Bestellzeichen Order-Code OMD	Brutto-Preis Gross-Price Euro (€)
LL	100	4	1/8" NPT						WE-LL-04-1/8"-NPT-OMD	12,74
LL	100	6	1/8" NPT						WE-LL-06-1/8"-NPT-OMD	13,26
LL	100	8	1/8" NPT						WE-LL-08-1/8"-NPT-OMD	13,90

Reihe Series	Druck Pressure PN	Rohr A.D. Tube O.D. D1	Gewinde Thread G	Ca. Maße Approx. Dimensions					Bestellzeichen Order-Code OMD	Brutto-Preis Gross-Price Euro (€)
L	315	6	1/8" NPT						WE-L-06-1/8"-NPT-OMD	14,20
L	315	6	1/4" NPT						WE-L-06-1/4"-NPT-OMD	15,15
L	315	6	3/8" NPT						WE-L-06-3/8"-NPT-OMD	20,88
L	315	6	1/2" NPT						WE-L-06-1/2"-NPT-OMD	24,76
L	315	8	1/8" NPT						WE-L-08-1/8"-NPT-OMD	15,76
L	315	8	1/4" NPT						WE-L-08-1/4"-NPT-OMD	16,63
L	315	8	3/8" NPT						WE-L-08-3/8"-NPT-OMD	20,87
L	315	8	1/2" NPT						WE-L-08-1/2"-NPT-OMD	24,50
L	315	10	1/8" NPT						WE-L-10-1/8"-NPT-OMD	20,11
L	315	10	1/4" NPT						WE-L-10-1/4"-NPT-OMD	19,24
L	315	10	3/8" NPT						WE-L-10-3/8"-NPT-OMD	20,42
L	315	10	1/2" NPT						WE-L-10-1/2"-NPT-OMD	23,48
L	315	12	1/8" NPT						WE-L-12-1/8"-NPT-OMD	21,01
L	315	12	1/4" NPT						WE-L-12-1/4"-NPT-OMD	20,42
L	315	12	3/8" NPT						WE-L-12-3/8"-NPT-OMD	20,42
L	315	12	1/2" NPT						WE-L-12-1/2"-NPT-OMD	23,18
L	315	15	3/8" NPT						WE-L-15-3/8"-NPT-OMD	25,51
L	315	15	1/2" NPT						WE-L-15-1/2"-NPT-OMD	25,51
L	160	15	3/4" NPT						WE-L-15-3/4"-NPT-OMD	41,52
L	315	18	3/8" NPT						WE-L-18-3/8"-NPT-OMD	34,40
L	315	18	1/2" NPT						WE-L-18-1/2"-NPT-OMD	33,28
L	160	18	3/4" NPT						WE-L-18-3/4"-NPT-OMD	42,52
L	160	22	1/2" NPT						WE-L-22-1/2"-NPT-OMD	41,33
L	160	22	3/4" NPT						WE-L-22-3/4"-NPT-OMD	41,33
L	160	28	3/4" NPT						WE-L-28-3/4"-NPT-OMD	89,90
L	160	28	1" NPT						WE-L-28-1"-NPT-OMD	82,30
L	160	35	1 1/4" NPT						WE-L-35-1 1/4"-NPT-OMD	129,72
L	160	42	1 1/2" NPT						WE-L-42-1 1/2"-NPT-OMD	179,65

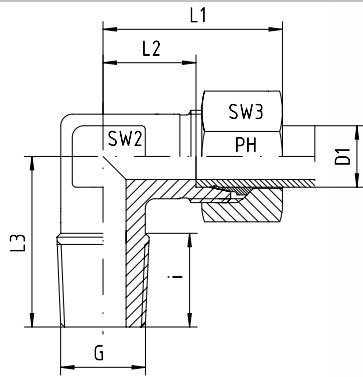

Winkel-Einschraubverschraubungen
S-Reihe
Einschraubgewinde: NPT

Stud Elbows
S-Series
Thread: NPT

Reihe Series	Druck Pressure PN	Rohr A.D. Tube O.D. D1	Gewinde Thread G	Ca. Maße Approx. Dimensions						Bestellzeichen Order-Code Standard	Brutto-Preis Gross-Price Euro (€)
				L1	L2	L3	i	SW2	SW3		
S	630	6	1/4" NPT	31	16,0	26	15,0	12	17	WE-S-06-1/4"-NPT	18,02
S	630	6	3/8" NPT	32	17,5	27	15,3	14	17	WE-S-06-3/8"-NPT	22,60
S	630	6	1/2" NPT	36	21,0	34	20,0	17	17	WE-S-06-1/2"-NPT	33,36
S	630	8	1/4" NPT	32	17,0	27	15,0	14	19	WE-S-08-1/4"-NPT	21,73
S	630	8	3/8" NPT	33	18,0	28	15,3	14	19	WE-S-08-3/8"-NPT	23,19
S	630	8	1/2" NPT	38	23,0	34	20,0	17	19	WE-S-08-1/2"-NPT	32,80
S	630	10	1/4" NPT	34	17,5	28	15,0	17	22	WE-S-10-1/4"-NPT	26,59
S	630	10	3/8" NPT	34	17,5	28	15,3	17	22	WE-S-10-3/8"-NPT	23,52
S	630	10	1/2" NPT	39	22,5	32	20,0	17	22	WE-S-10-1/2"-NPT	31,80
S	630	12	1/4" NPT	38	21,5	29	15,0	17	24	WE-S-12-1/4"-NPT	29,60
S	630	12	3/8" NPT	38	21,5	28	15,3	17	24	WE-S-12-3/8"-NPT	28,81
S	630	12	1/2" NPT	39	21,5	34	20,0	17	24	WE-S-12-1/2"-NPT	32,06
S	630	14	3/8" NPT	40	22,0	30	15,3	19	27	WE-S-14-3/8"-NPT	31,96
S	630	14	1/2" NPT	40	22,0	34	20,0	19	27	WE-S-14-1/2"-NPT	32,21
S	400	16	3/8" NPT	43	24,5	32	15,3	24	30	WE-S-16-3/8"-NPT	45,76
S	400	16	1/2" NPT	43	24,5	36	20,0	24	30	WE-S-16-1/2"-NPT	44,46
S	400	16	3/4" NPT	43	24,5	41	20,0	24	30	WE-S-16-3/4"-NPT	50,73
S	400	20	1/2" NPT	48	26,5	42	20,0	27	36	WE-S-20-1/2"-NPT	52,15
S	400	20	3/4" NPT	48	26,5	42	20,0	27	36	WE-S-20-3/4"-NPT	52,15
S	400	25	1" NPT	54	30,0	48	25,0	36	46	WE-S-25-1"-NPT	115,04
S	400	30	1 1/4" NPT	62	35,5	54	25,5	41	50	WE-S-30-1 1/4"-NPT	168,73
S	315	38	1 1/2" NPT	72	41,0	61	26,0	50	60	WE-S-38-1 1/2"-NPT	227,53

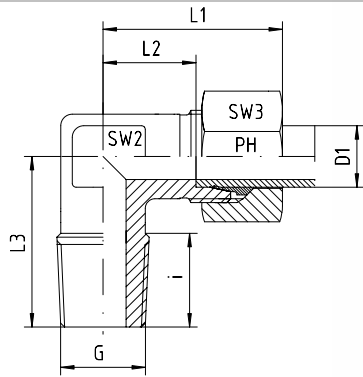

Winkel-Einschraubverschraubungen
S-Reihe
Einschraubgewinde: NPT

Stud Elbows
S-Series
Thread: NPT

Reihe Series	Druck Pressure PN	Rohr A.D. Tube O.D. D1	Gewinde Thread G	Ca. Maße Approx. Dimensions						Bestellzeichen Order-Code SC	Brutto-Preis Gross-Price Euro (€)
				L1	L2	L3	i	SW2	SW3		
S	630	6	1/4" NPT	31	16,0	26	15,0	12	17	WE-S-06-1/4"-NPT-SC	18,46
S	630	6	3/8" NPT	32	17,5	27	15,3	14	17	WE-S-06-3/8"-NPT-SC	23,04
S	630	6	1/2" NPT	36	21,0	34	20,0	17	17	WE-S-06-1/2"-NPT-SC	33,80
S	630	8	1/4" NPT	32	17,0	27	15,0	14	19	WE-S-08-1/4"-NPT-SC	22,17
S	630	8	3/8" NPT	33	18,0	28	15,3	14	19	WE-S-08-3/8"-NPT-SC	23,63
S	630	8	1/2" NPT	38	23,0	34	20,0	17	19	WE-S-08-1/2"-NPT-SC	33,24
S	630	10	1/4" NPT	34	17,5	28	15,0	17	22	WE-S-10-1/4"-NPT-SC	27,15
S	630	10	3/8" NPT	34	17,5	28	15,3	17	22	WE-S-10-3/8"-NPT-SC	24,08
S	630	10	1/2" NPT	39	22,5	32	20,0	17	22	WE-S-10-1/2"-NPT-SC	32,36
S	630	12	1/4" NPT	38	21,5	29	15,0	17	24	WE-S-12-1/4"-NPT-SC	30,44
S	630	12	3/8" NPT	38	21,5	28	15,3	17	24	WE-S-12-3/8"-NPT-SC	29,65
S	630	12	1/2" NPT	39	21,5	34	20,0	17	24	WE-S-12-1/2"-NPT-SC	32,90
S	630	14	3/8" NPT	40	22,0	30	15,3	19	27	WE-S-14-3/8"-NPT-SC	33,52
S	630	14	1/2" NPT	40	22,0	34	20,0	19	27	WE-S-14-1/2"-NPT-SC	33,77
S	400	16	3/8" NPT	43	24,5	32	15,3	24	30	WE-S-16-3/8"-NPT-SC	47,32
S	400	16	1/2" NPT	43	24,5	36	20,0	24	30	WE-S-16-1/2"-NPT-SC	46,02
S	400	16	3/4" NPT	43	24,5	41	20,0	24	30	WE-S-16-3/4"-NPT-SC	52,29
S	400	20	1/2" NPT	48	26,5	42	20,0	27	36	WE-S-20-1/2"-NPT-SC	54,03
S	400	20	3/4" NPT	48	26,5	42	20,0	27	36	WE-S-20-3/4"-NPT-SC	54,03
S	400	25	1" NPT	54	30,0	48	25,0	36	46	WE-S-25-1"-NPT-SC	118,04
S	400	30	1 1/4" NPT	62	35,5	54	25,5	41	50	WE-S-30-1 1/4"-NPT-SC	172,89
S	315	38	1 1/2" NPT	72	41,0	61	26,0	50	60	WE-S-38-1 1/2"-NPT-SC	233,17



Winkel-Einschraubverschraubungsstutzen
S-Reihe
Einschraubgewinde: NPT

Stud Elbow Bodies
S-Series
Thread: NPT

Reihe Series	Druck Pressure PN	Rohr A.D. Tube O.D. D1	Gewinde Thread G	Ca. Maße Approx. Dimensions						Bestellzeichen Order-Code OMD	Brutto-Preis Gross-Price Euro (€)
S	630	6	1/4" NPT							WE-S-06-1/4"-NPT-OMD	15,23
S	630	6	3/8" NPT							WE-S-06-3/8"-NPT-OMD	19,81
S	630	6	1/2" NPT							WE-S-06-1/2"-NPT-OMD	30,57
S	630	8	1/4" NPT							WE-S-08-1/4"-NPT-OMD	18,53
S	630	8	3/8" NPT							WE-S-08-3/8"-NPT-OMD	19,99
S	630	8	1/2" NPT							WE-S-08-1/2"-NPT-OMD	29,60
S	630	10	1/4" NPT							WE-S-10-1/4"-NPT-OMD	22,65
S	630	10	3/8" NPT							WE-S-10-3/8"-NPT-OMD	19,58
S	630	10	1/2" NPT							WE-S-10-1/2"-NPT-OMD	27,86
S	630	12	1/4" NPT							WE-S-12-1/4"-NPT-OMD	25,15
S	630	12	3/8" NPT							WE-S-12-3/8"-NPT-OMD	24,36
S	630	12	1/2" NPT							WE-S-12-1/2"-NPT-OMD	27,61
S	630	14	3/8" NPT							WE-S-14-3/8"-NPT-OMD	26,46
S	630	14	1/2" NPT							WE-S-14-1/2"-NPT-OMD	26,71
S	400	16	3/8" NPT							WE-S-16-3/8"-NPT-OMD	37,55
S	400	16	1/2" NPT							WE-S-16-1/2"-NPT-OMD	36,25
S	400	16	3/4" NPT							WE-S-16-3/4"-NPT-OMD	42,52
S	400	20	1/2" NPT							WE-S-20-1/2"-NPT-OMD	41,57
S	400	20	3/4" NPT							WE-S-20-3/4"-NPT-OMD	41,57
S	400	25	1" NPT							WE-S-25-1"-NPT-OMD	96,42
S	400	30	1 1/4" NPT							WE-S-30-1 1/4"-NPT-OMD	145,29
S	315	38	1 1/2" NPT							WE-S-38-1 1/2"-NPT-OMD	195,72

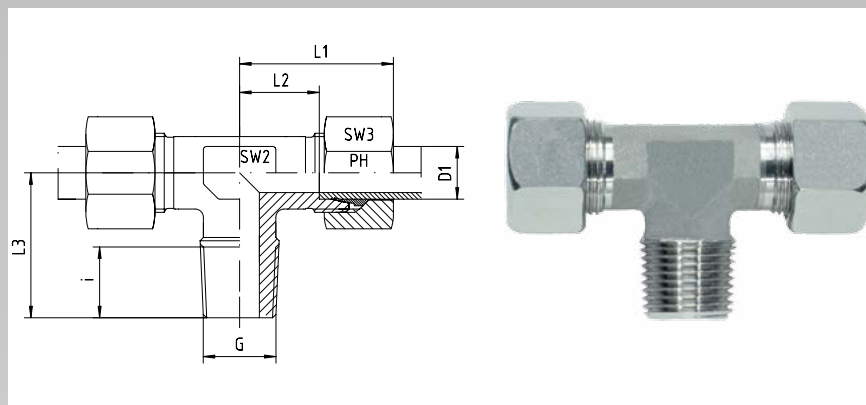

T-Einschraubverschraubungen
LL-, L- und S-Reihe
Einschraubgewinde: Whitworth-Rohrgewinde - Kegelig

Stud Branch Tees
LL-, L- and S-Series
Thread: BSP - Taper

Reihe Series	Druck Pressure PN	Rohr A.D. Tube O.D. D1	Gewinde Thread G	Ca. Maße Approx. Dimensions						Bestellzeichen Order-Code Standard	Brutto-Preis Gross-Price Euro (€)
				L1	L2	L3	i	SW2	SW3		
LL	100	4	R 1/8" keg	21	11,0	17	8	9	10	TE-LL-04-R 1/8"-k	28,44
LL	100	6	R 1/8" keg	21	9,5	17	8	9	12	TE-LL-06-R 1/8"-k	29,24
LL	100	8	R 1/8" keg	23	11,5	20	8	12	14	TE-LL-08-R 1/8"-k	30,93

Reihe Series	Druck Pressure PN	Rohr A.D. Tube O.D. D1	Gewinde Thread G	Ca. Maße Approx. Dimensions						Bestellzeichen Order-Code Standard	Brutto-Preis Gross-Price Euro (€)
				L1	L2	L3	i	SW2	SW3		
L	315	6	R 1/8" keg	27	12,0	20	8	12	14	TE-L-06-R 1/8"-k	23,93
L	315	6	R 1/4" keg	29	14,0	26	12	12	14	TE-L-06-R 1/4"-k	28,33
L	315	8	R 1/4" keg	29	14,0	26	12	12	17	TE-L-08-R 1/4"-k	28,33
L	315	8	R 3/8" keg	30	15,0	28	12	14	17	TE-L-08-R 3/8"-k	31,14
L	315	10	R 1/8" keg				8	14	19	TE-L-10-R 1/8"-k	*
L	315	10	R 1/4" keg	30	15,0	27	12	14	19	TE-L-10-R 1/4"-k	31,07
L	315	10	R 3/8" keg	30	15,0	27	12	17	19	TE-L-10-R 3/8"-k	34,26
L	315	10	R 1/2" keg	37	21,0	33	14	17	19	TE-L-10-R 1/2"-k	35,46
L	315	12	R 1/4" keg	32	17,0	28	12	17	22	TE-L-12-R 1/4"-k	34,77
L	315	12	R 3/8" keg	32	17,0	28	12	17	22	TE-L-12-R 3/8"-k	34,77
L	315	12	R 1/2" keg	38	20,5	34	14	17	22	TE-L-12-R 1/2"-k	39,88
L	315	15	R 3/8" keg	36	21,0	34	12	19	27	TE-L-15-R 3/8"-k	49,80
L	315	15	R 1/2" keg	36	21,0	34	14	19	27	TE-L-15-R 1/2"-k	47,53
L	315	18	R 1/2" keg	40	23,5	36	14	24	32	TE-L-18-R 1/2"-k	69,03

Reihe Series	Druck Pressure PN ⁽¹⁾	Rohr A.D. Tube O.D. D1	Gewinde Thread G	Ca. Maße Approx. Dimensions						Bestellzeichen Order-Code Standard	Brutto-Preis Gross-Price Euro (€)
				L1	L2	L3	i	SW2	SW3		
S	630	6	R 1/4" keg	31	16,0	26	12	12	17	TE-S-06-R 1/4"-k	28,63
S	630	8	R 1/4" keg	32	17,0	27	12	14	19	TE-S-08-R 1/4"-k	31,06
S	630	10	R 3/8" keg	34	17,5	28	12	17	22	TE-S-10-R 3/8"-k	35,05
S	630	12	R 3/8" keg	38	21,5	28	12	17	24	TE-S-12-R 3/8"-k	44,43
S	630	12	R 1/2" keg	38	21,5	34	14	19	24	TE-S-12-R 1/2"-k	57,06
S	630	14	R 1/2" keg	40	22,0	32	14	19	27	TE-S-14-R 1/2"-k	49,93
S	400	16	R 1/2" keg	43	24,5	32	14	24	30	TE-S-16-R 1/2"-k	69,03

⁽¹⁾ Die angegebenen Druckstufen sind nur gültig, wenn die Einschraublöcher mit kegeligem Gewinde vorhanden sind.

⁽¹⁾ The pressure rates are only valid, if the female parts are with tapered threads, too.

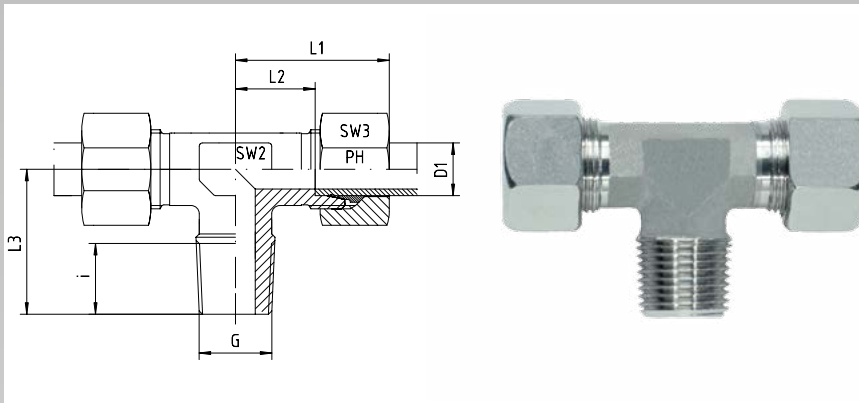

T-Einschraubverschraubungen
L- und S-Reihe
Einschraubgewinde: Whitworth-Rohrgewinde - Kegelig

Stud Branch Tees
L- and S-Series
Thread: BSP - Taper

Reihe Series	Druck Pressure PN	Rohr A.D. Tube O.D. D1	Gewinde Thread G	Ca. Maße Approx. Dimensions						Bestellzeichen Order-Code SC	Brutto-Preis Gross-Price Euro (€)
				L1	L2	L3	i	SW2	SW3		
L	315	6	R 1/8" keg	27	12,0	20	8	12	14	TE-L-06-R 1/8"-k-SC	24,57
L	315	6	R 1/4" keg	29	14,0	26	12	12	14	TE-L-06-R 1/4"-k-SC	28,97
L	315	8	R 1/4" keg	29	14,0	26	12	12	17	TE-L-08-R 1/4"-k-SC	29,21
L	315	8	R 3/8" keg	30	15,0	28	12	14	17	TE-L-08-R 3/8"-k-SC	32,02
L	315	10	R 1/8" keg				8	14	19	TE-L-10-R 1/8"-k-SC	*
L	315	10	R 1/4" keg	30	15,0	27	12	14	19	TE-L-10-R 1/4"-k-SC	31,95
L	315	10	R 3/8" keg	30	15,0	27	12	17	19	TE-L-10-R 3/8"-k-SC	35,14
L	315	10	R 1/2" keg	37	21,0	33	14	17	19	TE-L-10-R 1/2"-k-SC	36,34
L	315	12	R 1/4" keg	32	17,0	28	12	17	22	TE-L-12-R 1/4"-k-SC	35,89
L	315	12	R 3/8" keg	32	17,0	28	12	17	22	TE-L-12-R 3/8"-k-SC	35,89
L	315	12	R 1/2" keg	38	20,5	34	14	17	22	TE-L-12-R 1/2"-k-SC	41,00
L	315	15	R 3/8" keg	36	21,0	34	12	19	27	TE-L-15-R 3/8"-k-SC	51,12
L	315	15	R 1/2" keg	36	21,0	34	14	19	27	TE-L-15-R 1/2"-k-SC	49,69
L	315	18	R 1/2" keg	40	23,5	36	14	24	32	TE-L-18-R 1/2"-k-SC	72,31

Reihe Series	Druck Pressure PN ⁽¹⁾	Rohr A.D. Tube O.D. D1	Gewinde Thread G	Ca. Maße Approx. Dimensions						Bestellzeichen Order-Code SC	Brutto-Preis Gross-Price Euro (€)
				L1	L2	L3	i	SW2	SW3		
S	630	6	R 1/4" keg	31	16,0	26	12	12	17	TE-S-06-R 1/4"-k-SC	29,51
S	630	8	R 1/4" keg	32	17,0	27	12	14	19	TE-S-08-R 1/4"-k-SC	31,94
S	630	10	R 3/8" keg	34	17,5	28	12	17	22	TE-S-10-R 3/8"-k-SC	36,17
S	630	12	R 3/8" keg	38	21,5	28	12	17	24	TE-S-12-R 3/8"-k-SC	46,11
S	630	12	R 1/2" keg	38	21,5	34	14	19	24	TE-S-12-R 1/2"-k-SC	58,74
S	630	14	R 1/2" keg	40	22,0	32	14	19	27	TE-S-14-R 1/2"-k-SC	53,05
S	400	16	R 1/2" keg	43	24,5	32	14	24	30	TE-S-16-R 1/2"-k-SC	72,15

⁽¹⁾ Die angegebenen Druckstufen sind nur gültig, wenn die Einschraublöcher mit kegeligem Gewinde vorhanden sind.

⁽¹⁾ The pressure rates are only valid, if the female parts are with tapered threads, too.



T-Einschraubverschraubungsstutzen
LL-, L- und S-Reihe
Einschraubgewinde: Whitworth-Rohrgewinde - Kegelig

Stud Branch Tee Bodies
LL-, L- and S-Series
Thread: BSP - Taper

Reihe Series	Druck Pressure PN	Rohr A.D. Tube O.D. D1	Gewinde Thread G	Ca. Maße Approx. Dimensions					Bestellzeichen Order-Code OMD	Brutto-Preis Gross-Price Euro (€)
LL	100	4	R 1/8" keg						TE-LL-04-R 1/8"-k-OMD	23,12
LL	100	6	R 1/8" keg						TE-LL-06-R 1/8"-k-OMD	23,16
LL	100	8	R 1/8" keg						TE-LL-08-R 1/8"-k-OMD	23,93

Reihe Series	Druck Pressure PN	Rohr A.D. Tube O.D. D1	Gewinde Thread G	Ca. Maße Approx. Dimensions					Bestellzeichen Order-Code OMD	Brutto-Preis Gross-Price Euro (€)
L	315	6	R 1/8" keg						TE-L-06-R 1/8"-k-OMD	19,31
L	315	6	R 1/4" keg						TE-L-06-R 1/4"-k-OMD	23,71
L	315	8	R 1/4" keg						TE-L-08-R 1/4"-k-OMD	22,73
L	315	8	R 3/8" keg						TE-L-08-R 3/8"-k-OMD	25,54
L	315	10	R 1/8" keg						TE-L-10-R 1/8"-k-OMD	*
L	315	10	R 1/4" keg						TE-L-10-R 1/4"-k-OMD	24,35
L	315	10	R 3/8" keg						TE-L-10-R 3/8"-k-OMD	27,54
L	315	10	R 1/2" keg						TE-L-10-R 1/2"-k-OMD	28,74
L	315	12	R 1/4" keg						TE-L-12-R 1/4"-k-OMD	26,99
L	315	12	R 3/8" keg						TE-L-12-R 3/8"-k-OMD	26,99
L	315	12	R 1/2" keg						TE-L-12-R 1/2"-k-OMD	32,10
L	315	15	R 3/8" keg						TE-L-15-R 3/8"-k-OMD	39,53
L	315	15	R 1/2" keg						TE-L-15-R 1/2"-k-OMD	37,25
L	315	18	R 1/2" keg						TE-L-18-R 1/2"-k-OMD	51,79

Reihe Series	Druck Pressure PN ⁽¹⁾	Rohr A.D. Tube O.D. D1	Gewinde Thread G	Ca. Maße Approx. Dimensions					Bestellzeichen Order-Code OMD	Brutto-Preis Gross-Price Euro (€)
S	630	6	R 1/4" keg						TE-S-06-R 1/4"-k-OMD	23,05
S	630	8	R 1/4" keg						TE-S-08-R 1/4"-k-OMD	24,66
S	630	10	R 3/8" keg						TE-S-10-R 3/8"-k-OMD	27,17
S	630	12	R 3/8" keg						TE-S-12-R 3/8"-k-OMD	35,53
S	630	12	R 1/2" keg						TE-S-12-R 1/2"-k-OMD	48,16
S	630	14	R 1/2" keg						TE-S-14-R 1/2"-k-OMD	38,93
S	400	16	R 1/2" keg						TE-S-16-R 1/2"-k-OMD	52,61

⁽¹⁾ Die angegebenen Druckstufen sind nur gültig, wenn die Einschraublöcher mit kegeligem Gewinde vorhanden sind.

⁽¹⁾ The pressure rates are only valid, if the female parts are with tapered threads, too.



T-Einschraubverschraubungen
L- und S-Reihe
Einschraubgewinde: Whitworth-Rohrgewinde - Zylindrisch
Abdichtung durch Dichtkante Form B

Stud Branch Tees
L- and S-Series
Thread: BSP - Parallel
Sealing by Sealing Shoulder Form B

Reihe Series	Druck Pressure PN	Rohr A.D. Tube O.D. D1	Gewinde Thread G	Ca. Maße Approx. Dimensions						Bestellzeichen Order-Code Standard	Brutto-Preis Gross-Price Euro (€)
				L1	L2	L3	i	SW2	SW3		
L	160	22	G 3/4" zyl	44	27,5	26	16	27	36	TE-L-22-R 3/4"-z	87,43
L	160	28	G 1" zyl	47	30,5	30	18	36	41	TE-L-28-R 1"-z	143,16
L	160	35	G 1 1/4" zyl	56	34,5	34	20	41	50	TE-L-35-R 1 1/4"-z	269,45
L	160	42	G 1 1/2" zyl	63	40,0	39	22	50	60	TE-L-42-R 1 1/2"-z	281,21

Reihe Series	Druck Pressure PN	Rohr A.D. Tube O.D. D1	Gewinde Thread G	Ca. Maße Approx. Dimensions						Bestellzeichen Order-Code Standard	Brutto-Preis Gross-Price Euro (€)
				L1	L2	L3	i	SW2	SW3		
S	400	20	G 3/4" zyl	48	26,5	26	16	27	36	TE-S-20-R 3/4"-z	87,43
S	250	25	G 1" zyl	54	30,0	30	18	36	46	TE-S-25-R 1"-z	152,88
S	160	30	G 1 1/4" zyl	62	35,5	34	20	41	50	TE-S-30-R 1 1/4"-z	204,52
S	160	38	G 1 1/2" zyl	72	41,0	39	22	50	60	TE-S-38-R 1 1/2"-z	375,81



T-Einschraubverschraubungen

L- und S-Reihe

Einschraubgewinde: Whitworth-Rohrgewinde - Zylindrisch
Abdichtung durch Dichtkante Form B

Stud Branch Tees

L- and S-Series

Thread: BSP - Parallel

Sealing by Sealing Shoulder Form B

Reihe Series	Druck Pressure PN	Rohr A.D. Tube O.D. D1	Gewinde Thread G	Ca. Maße Approx. Dimensions						Bestellzeichen Order-Code SC	Brutto-Preis Gross-Price Euro (€)
				L1	L2	L3	i	SW2	SW3		
L	160	22	G 3/4" zyl	44	27,5	26	16	27	36	TE-L-22-R 3/4"-z-SC	90,95
L	160	28	G 1" zyl	47	30,5	30	18	36	41	TE-L-28-R 1"-z-SC	147,16
L	160	35	G 1 1/4" zyl	56	34,5	34	20	41	50	TE-L-35-R 1 1/4"-z-SC	276,89
L	160	42	G 1 1/2" zyl	63	40,0	39	22	50	60	TE-L-42-R 1 1/2"-z-SC	289,85

Reihe Series	Druck Pressure PN	Rohr A.D. Tube O.D. D1	Gewinde Thread G	Ca. Maße Approx. Dimensions						Bestellzeichen Order-Code SC	Brutto-Preis Gross-Price Euro (€)
				L1	L2	L3	i	SW2	SW3		
S	400	20	G 3/4" zyl	48	26,5	26	16	27	36	TE-S-20-R 3/4"-z-SC	91,19
S	250	25	G 1" zyl	54	30,0	30	18	36	46	TE-S-25-R 1"-z-SC	158,88
S	160	30	G 1 1/4" zyl	62	35,5	34	20	41	50	TE-S-30-R 1 1/4"-z-SC	212,84
S	160	38	G 1 1/2" zyl	72	41,0	39	22	50	60	TE-S-38-R 1 1/2"-z-SC	387,09



T-Einschraubverschraubungsstutzen

L- und S-Reihe

Einschraubgewinde: Whitworth-Rohrgewinde - Zylindrisch
Abdichtung durch Dichtkante Form B

Stud Branch Tee Bodies

L- and S-Series

Thread: BSP - Parallel

Sealing by Sealing Shoulder Form B

Reihe Series	Druck Pressure PN	Rohr A.D. Tube O.D. D1	Gewinde Thread G	Ca. Maße Approx. Dimensions						Bestellzeichen Order-Code OMD	Brutto-Preis Gross-Price Euro (€)
L	160	22	G 3/4" zyl							TE-L-22-R 3/4"-z-OMD	66,81
L	160	28	G 1" zyl							TE-L-28-R 1"-z-OMD	113,46
L	160	35	G 1 1/4" zyl							TE-L-35-R 1 1/4"-z-OMD	227,23
L	160	42	G 1 1/2" zyl							TE-L-42-R 1 1/2"-z-OMD	226,35

Reihe Series	Druck Pressure PN	Rohr A.D. Tube O.D. D1	Gewinde Thread G	Ca. Maße Approx. Dimensions						Bestellzeichen Order-Code OMD	Brutto-Preis Gross-Price Euro (€)
S	400	20	G 3/4" zyl							TE-S-20-R 3/4"-z-OMD	66,27
S	250	25	G 1" zyl							TE-S-25-R 1"-z-OMD	115,64
S	160	30	G 1 1/4" zyl							TE-S-30-R 1 1/4"-z-OMD	157,64
S	160	38	G 1 1/2" zyl							TE-S-38-R 1 1/2"-z-OMD	312,53

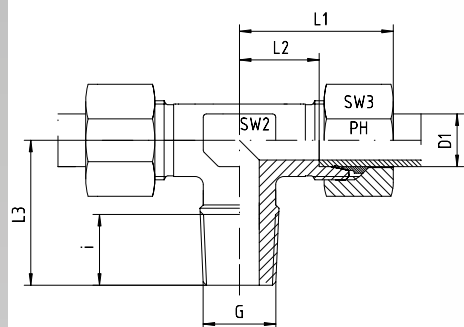

T-Einschraubverschraubungen
LL-, L- und S-Reihe
Einschraubgewinde: Metrisches Feingewinde - Kegelig

Stud Branch Tees
LL-, L- and S-Series
Thread: Metric - Taper

Reihe Series	Druck Pressure PN	Rohr A.D. Tube O.D. D1	Gewinde Thread G	Ca. Maße Approx. Dimensions						Bestellzeichen Order-Code Standard	Brutto-Preis Gross-Price Euro (€)
				L1	L2	L3	i	SW2	SW3		
LL	100	4	M 6 x 1 keg	21	11,0	17	8	9	10	TE-LL-04-M 6x1-k	28,12
LL	100	4	M 8 x 1 keg	21	11,0	17	8	9	10	TE-LL-04-M 8x1-k	28,12
LL	100	6	M 6 x 1 keg	21	9,5	17	8	9	12	TE-LL-06-M 6x1-k	30,17
LL	100	6	M 8 x 1 keg	21	9,5	17	8	9	12	TE-LL-06-M 8x1-k	30,17
LL	100	6	M 10 x 1 keg	21	9,5	17	8	9	12	TE-LL-06-M 10x1-k	29,14
LL	100	8	M 8 x 1 keg	23	11,5	20	8	12	14	TE-LL-08-M 8x1-k	*
LL	100	8	M 10 x 1 keg	23	11,5	20	8	12	14	TE-LL-08-M 10x1-k	31,96

Reihe Series	Druck Pressure PN	Rohr A.D. Tube O.D. D1	Gewinde Thread G	Ca. Maße Approx. Dimensions						Bestellzeichen Order-Code Standard	Brutto-Preis Gross-Price Euro (€)
				L1	L2	L3	i	SW2	SW3		
L	315	6	M 10 x 1 keg	27	12,0	20	8	12	14	TE-L-06-M 10x1-k	26,59
L	315	8	M 12 x 1,5 keg	29	14,0	26	12	12	17	TE-L-08-M 12x1,5-k	28,48
L	315	10	M 14 x 1,5 keg	30	15,0	27	12	14	19	TE-L-10-M 14x1,5-k	31,44
L	315	12	M 16 x 1,5 keg	32	17,0	28	12	17	22	TE-L-12-M 16x1,5-k	37,04
L	315	15	M 18 x 1,5 keg	36	21,0	32	12	19	27	TE-L-15-M 18x1,5-k	50,72
L	315	18	M 22 x 1,5 keg	40	23,5	36	14	24	32	TE-L-18-M 22x1,5-k	81,81

Reihe Series	Druck Pressure PN ⁽¹⁾	Rohr A.D. Tube O.D. D1	Gewinde Thread G	Ca. Maße Approx. Dimensions						Bestellzeichen Order-Code Standard	Brutto-Preis Gross-Price Euro (€)
				L1	L2	L3	i	SW2	SW3		
S	630	6	M 12 x 1,5 keg	31	16,0	26	12	12	17	TE-S-06-M 12x1,5-k	28,20
S	630	8	M 14 x 1,5 keg	32	17,0	27	12	14	19	TE-S-08-M 14x1,5-k	31,19
S	630	10	M 16 x 1,5 keg	34	17,5	28	12	17	22	TE-S-10-M 16x1,5-k	36,94
S	630	12	M 18 x 1,5 keg	38	21,5	28	12	17	24	TE-S-12-M 18x1,5-k	41,85
S	630	14	M 20 x 1,5 keg	40	22,0	32	14	17	27	TE-S-14-M 20x1,5-k	51,62
S	400	16	M 22 x 1,5 keg	43	24,5	32	14	19	30	TE-S-16-M 22x1,5-k	79,25

⁽¹⁾ Die angegebenen Druckstufen sind nur gültig, wenn die Einschraublöcher mit kegeligem Gewinde vorhanden sind.

⁽¹⁾ The pressure rates are only valid, if the female parts are with tapered threads, too.

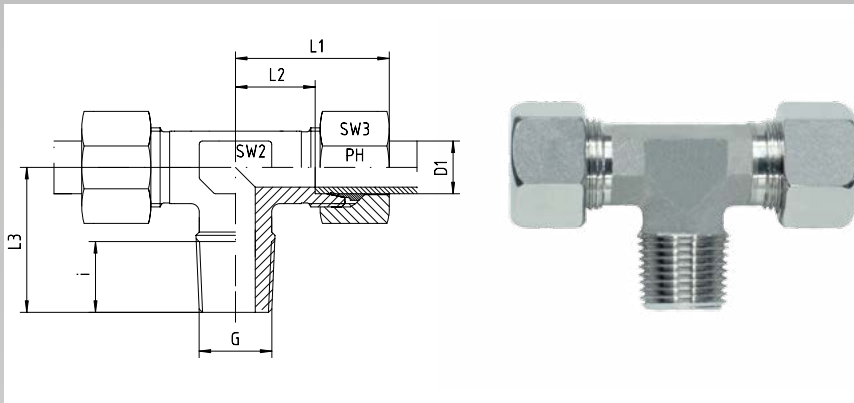

T-Einschraubverschraubungen
L- und S-Reihe
Einschraubgewinde: Metrisches Feingewinde - Kegelig

Stud Branch Tees
L- and S-Series
Thread: Metric - Taper

Reihe Series	Druck Pressure PN	Rohr A.D. Tube O.D. D1	Gewinde Thread G	Ca. Maße Approx. Dimensions						Bestellzeichen Order-Code SC	Brutto-Preis Gross-Price Euro (€)
				L1	L2	L3	i	SW2	SW3		
L	315	6	M 10 x 1 keg	27	12,0	20	8	12	14	TE-L-06-M 10x1-k-SC	27,23
L	315	8	M 12 x 1,5 keg	29	14,0	26	12	12	17	TE-L-08-M 12x1,5-k-SC	29,36
L	315	10	M 14 x 1,5 keg	30	15,0	27	12	14	19	TE-L-10-M 14x1,5-k-SC	32,32
L	315	12	M 16 x 1,5 keg	32	17,0	28	12	17	22	TE-L-12-M 16x1,5-k-SC	38,16
L	315	15	M 18 x 1,5 keg	36	21,0	32	12	19	27	TE-L-15-M 18x1,5-k-SC	52,88
L	315	18	M 22 x 1,5 keg	40	23,5	36	14	24	32	TE-L-18-M 22x1,5-k-SC	85,09

Reihe Series	Druck Pressure PN ⁽¹⁾	Rohr A.D. Tube O.D. D1	Gewinde Thread G	Ca. Maße Approx. Dimensions						Bestellzeichen Order-Code SC	Brutto-Preis Gross-Price Euro (€)
				L1	L2	L3	i	SW2	SW3		
S	630	6	M 12 x 1,5 keg	31	16,0	26	12	12	17	TE-S-06-M 12x1,5-k-SC	29,08
S	630	8	M 14 x 1,5 keg	32	17,0	27	12	14	19	TE-S-08-M 14x1,5-k-SC	32,07
S	630	10	M 16 x 1,5 keg	34	17,5	28	12	17	22	TE-S-10-M 16x1,5-k-SC	38,06
S	630	12	M 18 x 1,5 keg	38	21,5	28	12	17	24	TE-S-12-M 18x1,5-k-SC	43,53
S	630	14	M 20 x 1,5 keg	40	22,0	32	14	17	27	TE-S-14-M 20x1,5-k-SC	54,74
S	400	16	M 22 x 1,5 keg	43	24,5	32	14	19	30	TE-S-16-M 22x1,5-k-SC	82,37

⁽¹⁾ Die angegebenen Druckstufen sind nur gültig, wenn die Einschraublöcher mit kegeligem Gewinde vorhanden sind.

⁽¹⁾ The pressure rates are only valid, if the female parts are with tapered threads, too.



T-Einschraubverschraubungsstutzen
LL-, L- und S-Reihe
Einschraubgewinde: Metrisches Feingewinde - Kegelig

Stud Branch Tee Bodies
LL-, L- and S-Series
Thread: Metric - Taper

Reihe Series	Druck Pressure PN	Rohr A.D. Tube O.D. D1	Gewinde Thread G	Ca. Maße Approx. Dimensions					Bestellzeichen Order-Code OMD	Brutto-Preis Gross-Price Euro (€)
LL	100	4	M 6 x 1 keg						TE-LL-04-M 6x1-k-OMD	22,80
LL	100	4	M 8 x 1 keg						TE-LL-04-M 8x1-k-OMD	22,80
LL	100	6	M 6 x 1 keg						TE-LL-06-M 6x1-k-OMD	24,09
LL	100	6	M 8 x 1 keg						TE-LL-06-M 8x1-k-OMD	24,09
LL	100	6	M 10 x 1 keg						TE-LL-06-M 10x1-k-OMD	23,06
LL	100	8	M 8 x 1 keg						TE-LL-08-M 8x1-k-OMD	*
LL	100	8	M 10 x 1 keg						TE-LL-08-M 10x1-k-OMD	24,96

Reihe Series	Druck Pressure PN	Rohr A.D. Tube O.D. D1	Gewinde Thread G	Ca. Maße Approx. Dimensions					Bestellzeichen Order-Code OMD	Brutto-Preis Gross-Price Euro (€)
L	315	6	M 10 x 1 keg						TE-L-06-M 10x1-k-OMD	21,97
L	315	8	M 12 x 1,5 keg						TE-L-08-M 12x1,5-k-OMD	22,88
L	315	10	M 14 x 1,5 keg						TE-L-10-M 14x1,5-k-OMD	24,72
L	315	12	M 16 x 1,5 keg						TE-L-12-M 16x1,5-k-OMD	29,26
L	315	15	M 18 x 1,5 keg						TE-L-15-M 18x1,5-k-OMD	40,44
L	315	18	M 22 x 1,5 keg						TE-L-18-M 22x1,5-k-OMD	64,57

Reihe Series	Druck Pressure PN ⁽¹⁾	Rohr A.D. Tube O.D. D1	Gewinde Thread G	Ca. Maße Approx. Dimensions					Bestellzeichen Order-Code OMD	Brutto-Preis Gross-Price Euro (€)
S	630	6	M 12 x 1,5 keg						TE-S-06-M 12x1,5-k-OMD	22,62
S	630	8	M 14 x 1,5 keg						TE-S-08-M 14x1,5-k-OMD	24,79
S	630	10	M 16 x 1,5 keg						TE-S-10-M 16x1,5-k-OMD	29,06
S	630	12	M 18 x 1,5 keg						TE-S-12-M 18x1,5-k-OMD	32,95
S	630	14	M 20 x 1,5 keg						TE-S-14-M 20x1,5-k-OMD	40,62
S	400	16	M 22 x 1,5 keg						TE-S-16-M 22x1,5-k-OMD	62,83

⁽¹⁾ Die angegebenen Druckstufen sind nur gültig, wenn die Einschraublöcher mit kegeligem Gewinde vorhanden sind.
⁽¹⁾ The pressure rates are only valid, if the female parts are with tapered threads, too.

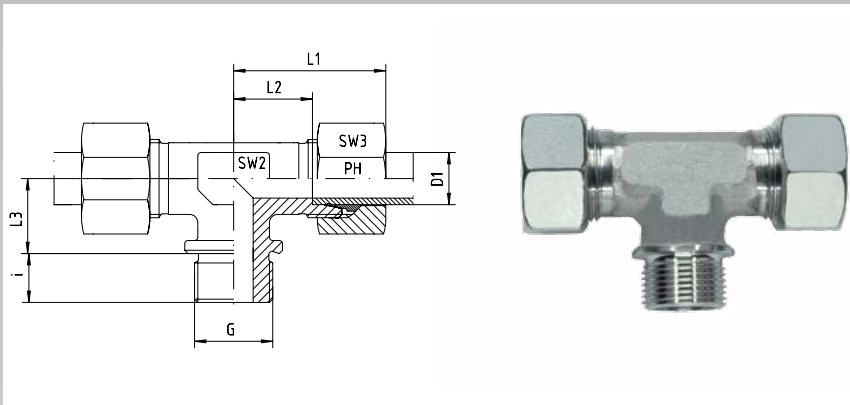

T-Einschraubverschraubungen
L- und S-Reihe
Einschraubgewinde: Metrisches Feingewinde - Zylindrisch
Abdichtung durch Dichtkante Form B

Stud Branch Tees
L- and S-Series
Thread: Metric - Parallel
Sealing by Sealing Shoulder Form B

Reihe Series	Druck Pressure PN	Rohr A.D. Tube O.D. D1	Gewinde Thread G	Ca. Maße Approx. Dimensions						Bestellzeichen Order-Code Standard	Brutto-Preis Gross-Price Euro (€)
				L1	L2	L3	i	SW2	SW3		
L	160	22	M 26 x 1,5 zyl	44	27,5	26	16	27	36	TE-L-22-M 26x1,5-z	87,94
L	160	28	M 33 x 2 zyl	47	30,5	30	18	36	41	TE-L-28-M 33x2-z	143,16
L	160	35	M 42 x 2 zyl	56	34,5	34	20	41	50	TE-L-35-M 42x2-z	270,99
L	160	42	M 48 x 2 zyl	63	40,0	39	22	50	60	TE-L-42-M 48x2-z	279,68

Reihe Series	Druck Pressure PN	Rohr A.D. Tube O.D. D1	Gewinde Thread G	Ca. Maße Approx. Dimensions						Bestellzeichen Order-Code Standard	Brutto-Preis Gross-Price Euro (€)
				L1	L2	L3	i	SW2	SW3		
S	400	20	M 27 x 2 zyl	48	26,5	26	16	27	36	TE-S-20-M 27x2-z	87,94
S	250	25	M 33 x 2 zyl	54	30,0	30	18	36	46	TE-S-25-M 33x2-z	153,24
S	160	30	M 42 x 2 zyl	62	35,5	34	20	41	50	TE-S-30-M 42x2-z	202,47
S	160	38	M 48 x 2 zyl	72	41,0	39	22	50	60	TE-S-38-M 48x2-z	378,36



T-Einschraubverschraubungen
L- und S-Reihe
Einschraubgewinde: Metrisches Feingewinde - Zylindrisch
Abdichtung durch Dichtkante Form B

Stud Branch Tees
L- and S-Series
Thread: Metric - Parallel
Sealing by Sealing Shoulder Form B

Reihe Series	Druck Pressure PN	Rohr A.D. Tube O.D. D1	Gewinde Thread G	Ca. Maße Approx. Dimensions						Bestellzeichen Order-Code SC	Brutto-Preis Gross-Price Euro (€)
				L1	L2	L3	i	SW2	SW3		
L	160	22	M 26 x 1,5 zyl	44	27,5	26	16	27	36	TE-L-22-M 26x1,5-z-SC	91,46
L	160	28	M 33 x 2 zyl	47	30,5	30	18	36	41	TE-L-28-M 33x2-z-SC	147,16
L	160	35	M 42 x 2 zyl	56	34,5	34	20	41	50	TE-L-35-M 42x2-z-SC	278,43
L	160	42	M 48 x 2 zyl	63	40,0	39	22	50	60	TE-L-42-M 48x2-z-SC	288,32

Reihe Series	Druck Pressure PN	Rohr A.D. Tube O.D. D1	Gewinde Thread G	Ca. Maße Approx. Dimensions						Bestellzeichen Order-Code SC	Brutto-Preis Gross-Price Euro (€)
				L1	L2	L3	i	SW2	SW3		
S	400	20	M 27 x 2 zyl	48	26,5	26	16	27	36	TE-S-20-M 27x2-z-SC	91,70
S	250	25	M 33 x 2 zyl	54	30,0	30	18	36	46	TE-S-25-M 33x2-z-SC	159,24
S	160	30	M 42 x 2 zyl	62	35,5	34	20	41	50	TE-S-30-M 42x2-z-SC	210,79
S	160	38	M 48 x 2 zyl	72	41,0	39	22	50	60	TE-S-38-M 48x2-z-SC	389,64



T-Einschraubverschraubungsstutzen

L- und S-Reihe

Einschraubgewinde: Metrisches Feingewinde - Zylindrisch
 Abdichtung durch Dichtkante Form B

Stud Branch Tee Bodies

L- and S-Series

Thread: Metric - Parallel

Sealing by Sealing Shoulder Form B

Reihe Series	Druck Pressure PN	Rohr A.D. Tube O.D. D1	Gewinde Thread G	Ca. Maße Approx. Dimensions						Bestellzeichen Order-Code OMD	Brutto-Preis Gross-Price Euro (€)
L	160	22	M 26 x 1,5 zyl							TE-L-22-M 26x1,5-z-OMD	67,32
L	160	28	M 33 x 2 zyl							TE-L-28-M 33x2-z-OMD	113,46
L	160	35	M 42 x 2 zyl							TE-L-35-M 42x2-z-OMD	228,77
L	160	42	M 48 x 2 zyl							TE-L-42-M 48x2-z-OMD	224,82

Reihe Series	Druck Pressure PN	Rohr A.D. Tube O.D. D1	Gewinde Thread G	Ca. Maße Approx. Dimensions						Bestellzeichen Order-Code OMD	Brutto-Preis Gross-Price Euro (€)
S	400	20	M 27 x 2 zyl							TE-S-20-M 27x2-z-OMD	66,78
S	250	25	M 33 x 2 zyl							TE-S-25-M 33x2-z-OMD	116,00
S	160	30	M 42 x 2 zyl							TE-S-30-M 42x2-z-OMD	155,59
S	160	38	M 48 x 2 zyl							TE-S-38-M 48x2-z-OMD	315,08

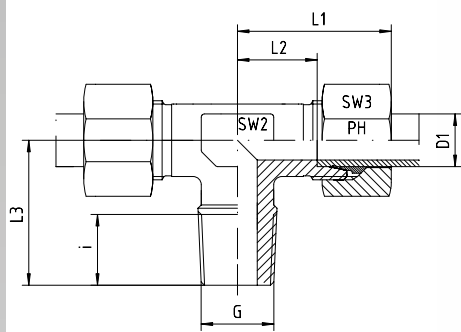

T-Einschraubverschraubungen
LL-, L- und S-Reihe
Einschraubgewinde: NPT

Stud Branch Tees
LL-, L- and S-Series
Thread: NPT

Reihe Series	Druck Pressure PN	Rohr A.D. Tube O.D. D1	Gewinde Thread G	Ca. Maße Approx. Dimensions						Bestellzeichen Order-Code Standard	Brutto-Preis Gross-Price Euro (€)
				L1	L2	L3	i	SW2	SW3		
LL	100	4	1/8" NPT	21	11,0	17,0	10,0	9	10	TE-LL-04-1/8"-NPT	*
LL	100	6	1/8" NPT	21	9,5	17,0	10,0	9	12	TE-LL-06-1/8"-NPT	28,38
LL	100	8	1/8" NPT	23	11,5	20,0	10,0	12	14	TE-LL-08-1/8"-NPT	29,14

Reihe Series	Druck Pressure PN	Rohr A.D. Tube O.D. D1	Gewinde Thread G	Ca. Maße Approx. Dimensions						Bestellzeichen Order-Code Standard	Brutto-Preis Gross-Price Euro (€)
				L1	L2	L3	i	SW2	SW3		
L	315	6	1/8" NPT	27	12,0	20,0	10,0	12	14	TE-L-06-1/8"-NPT	30,17
L	315	6	1/4" NPT	27	12,0	25,0	15,0	12	14	TE-L-06-1/4"-NPT	31,70
L	315	8	1/4" NPT	29	14,0	26,0	15,0	12	17	TE-L-08-1/4"-NPT	31,93
L	315	10	1/4" NPT	30	15,0	27,0	15,0	14	19	TE-L-10-1/4"-NPT	35,28
L	315	10	3/8" NPT	30	15,0	27,5	15,3	14	19	TE-L-10-3/8"-NPT	42,18
L	315	10	1/2" NPT	37	21,0	33,0	20,0	17	19	TE-L-10-1/2"-NPT	44,38
L	315	12	1/4" NPT	32	17,0	28,0	15,0	17	22	TE-L-12-1/4"-NPT	42,57
L	315	12	3/8" NPT	32	17,0	28,0	15,3	17	22	TE-L-12-3/8"-NPT	42,57
L	315	12	1/2" NPT	36	21,0	34,0	20,0	17	22	TE-L-12-1/2"-NPT	44,74
L	315	15	3/8" NPT	36	21,0	34,0	15,3	19	27	TE-L-15-3/8"-NPT	*
L	315	15	1/2" NPT	36	21,0	34,0	20,0	19	27	TE-L-15-1/2"-NPT	58,54
L	315	18	1/2" NPT	40	23,5	36,0	20,0	24	32	TE-L-18-1/2"-NPT	94,59
L	160	22	3/4" NPT	44	27,5	42,0	20,0	27	36	TE-L-22-3/4"-NPT	99,70
L	160	28	1" NPT	47	30,5	48,0	25,0	36	41	TE-L-28-1"-NPT	163,62
L	160	35	1 1/4" NPT	56	34,5	54,0	25,5	41	50	TE-L-35-1 1/4"-NPT	309,34
L	160	42	1 1/2" NPT	63	40,0	61,0	26,0	50	60	TE-L-42-1 1/2"-NPT	317,01

Reihe Series	Druck Pressure PN	Rohr A.D. Tube O.D. D1	Gewinde Thread G	Ca. Maße Approx. Dimensions						Bestellzeichen Order-Code Standard	Brutto-Preis Gross-Price Euro (€)
				L1	L2	L3	i	SW2	SW3		
S	630	6	1/4" NPT	31	16,0	26,0	15,0	12	17	TE-S-06-1/4"-NPT	32,88
S	630	8	1/4" NPT	32	17,0	27,0	15,0	14	19	TE-S-08-1/4"-NPT	33,59
S	630	10	1/4" NPT	34	17,5	28,0	15,0	17	22	TE-S-10-1/4"-NPT	*
S	630	10	3/8" NPT	34	17,5	28,0	15,3	17	22	TE-S-10-3/8"-NPT	40,98
S	630	10	1/2" NPT				20,0	17	22	TE-S-10-1/2"-NPT	*
S	630	12	1/4" NPT	38	21,5	29,0	15,0	17	24	TE-S-12-1/4"-NPT	*
S	630	12	3/8" NPT	38	21,5	28,0	15,3	17	24	TE-S-12-3/8"-NPT	47,93
S	630	12	1/2" NPT	39	21,5	34,0	20,0	19	24	TE-S-12-1/2"-NPT	64,80
S	630	14	1/2" NPT	40	22,0	34,0	20,0	19	27	TE-S-14-1/2"-NPT	58,80
S	400	16	1/2" NPT	43	24,5	36,0	20,0	24	30	TE-S-16-1/2"-NPT	92,03
S	400	20	3/4" NPT	48	26,5	42,0	20,0	27	36	TE-S-20-3/4"-NPT	112,49
S	400	25	1" NPT	54	30,0	48,0	25,0	36	46	TE-S-25-1"-NPT	173,84
S	400	30	1 1/4" NPT	62	35,5	54,0	25,5	41	50	TE-S-30-1 1/4"-NPT	232,64
S	315	38	1 1/2" NPT	72	41,0	61,0	26,0	50	60	TE-S-38-1 1/2"-NPT	432,05

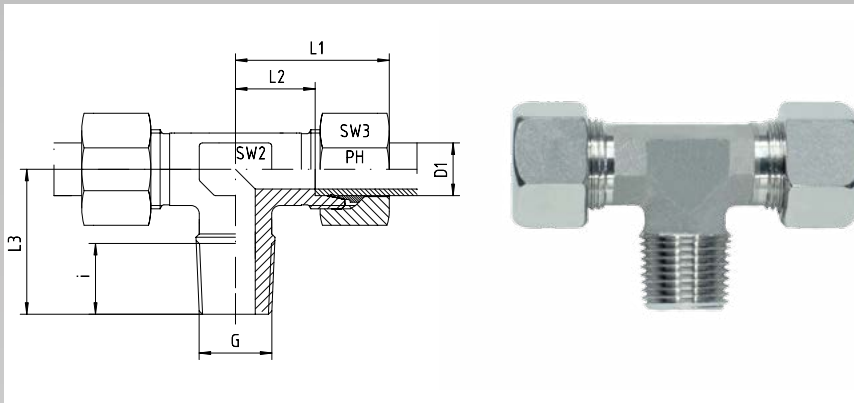

T-Einschraubverschraubungen
L- und S-Reihe
Einschraubgewinde: NPT

Stud Branch Tees
L- and S-Series
Thread: NPT

Reihe Series	Druck Pressure PN	Rohr A.D. Tube O.D. D1	Gewinde Thread G	Ca. Maße Approx. Dimensions						Bestellzeichen Order-Code SC	Brutto-Preis Gross-Price Euro (€)
				L1	L2	L3	i	SW2	SW3		
L	315	6	1/8" NPT	27	12,0	20,0	10,0	12	14	TE-L-06-1/8"-NPT-SC	30,81
L	315	6	1/4" NPT	27	12,0	25,0	15,0	12	14	TE-L-06-1/4"-NPT-SC	32,34
L	315	8	1/4" NPT	29	14,0	26,0	15,0	12	17	TE-L-08-1/4"-NPT-SC	32,81
L	315	10	1/4" NPT	30	15,0	27,0	15,0	14	19	TE-L-10-1/4"-NPT-SC	36,16
L	315	10	3/8" NPT	30	15,0	27,5	15,3	14	19	TE-L-10-3/8"-NPT-SC	43,06
L	315	10	1/2" NPT	37	21,0	33,0	20,0	17	19	TE-L-10-1/2"-NPT-SC	45,26
L	315	12	1/4" NPT	32	17,0	28,0	15,0	17	22	TE-L-12-1/4"-NPT-SC	43,69
L	315	12	3/8" NPT	32	17,0	28,0	15,3	17	22	TE-L-12-3/8"-NPT-SC	43,69
L	315	12	1/2" NPT	36	21,0	34,0	20,0	17	22	TE-L-12-1/2"-NPT-SC	45,86
L	315	15	3/8" NPT	36	21,0	34,0	15,3	19	27	TE-L-15-3/8"-NPT-SC	*
L	315	15	1/2" NPT	36	21,0	34,0	20,0	19	27	TE-L-15-1/2"-NPT-SC	60,70
L	315	18	1/2" NPT	40	23,5	36,0	20,0	24	32	TE-L-18-1/2"-NPT-SC	97,87
L	160	22	3/4" NPT	44	27,5	42,0	20,0	27	36	TE-L-22-3/4"-NPT-SC	103,22
L	160	28	1" NPT	47	30,5	48,0	25,0	36	41	TE-L-28-1"-NPT-SC	167,62
L	160	35	1 1/4" NPT	56	34,5	54,0	25,5	41	50	TE-L-35-1 1/4"-NPT-SC	316,78
L	160	42	1 1/2" NPT	63	40,0	61,0	26,0	50	60	TE-L-42-1 1/2"-NPT-SC	325,65

Reihe Series	Druck Pressure PN	Rohr A.D. Tube O.D. D1	Gewinde Thread G	Ca. Maße Approx. Dimensions						Bestellzeichen Order-Code SC	Brutto-Preis Gross-Price Euro (€)
				L1	L2	L3	i	SW2	SW3		
S	630	6	1/4" NPT	31	16,0	26,0	15,0	12	17	TE-S-06-1/4"-NPT-SC	33,76
S	630	8	1/4" NPT	32	17,0	27,0	15,0	14	19	TE-S-08-1/4"-NPT-SC	34,47
S	630	10	1/4" NPT	34	17,5	28,0	15,0	17	22	TE-S-10-1/4"-NPT-SC	*
S	630	10	3/8" NPT	34	17,5	28,0	15,3	17	22	TE-S-10-3/8"-NPT-SC	42,10
S	630	10	1/2" NPT				20,0	17	22	TE-S-10-1/2"-NPT-SC	*
S	630	12	1/4" NPT	38	21,5	29,0	15,0	17	24	TE-S-12-1/4"-NPT-SC	*
S	630	12	3/8" NPT	38	21,5	28,0	15,3	17	24	TE-S-12-3/8"-NPT-SC	49,61
S	630	12	1/2" NPT	39	21,5	34,0	20,0	19	24	TE-S-12-1/2"-NPT-SC	66,48
S	630	14	1/2" NPT	40	22,0	34,0	20,0	19	27	TE-S-14-1/2"-NPT-SC	61,92
S	400	16	1/2" NPT	43	24,5	36,0	20,0	24	30	TE-S-16-1/2"-NPT-SC	95,15
S	400	20	3/4" NPT	48	26,5	42,0	20,0	27	36	TE-S-20-3/4"-NPT-SC	116,25
S	400	25	1" NPT	54	30,0	48,0	25,0	36	46	TE-S-25-1"-NPT-SC	179,84
S	400	30	1 1/4" NPT	62	35,5	54,0	25,5	41	50	TE-S-30-1 1/4"-NPT-SC	240,96
S	315	38	1 1/2" NPT	72	41,0	61,0	26,0	50	60	TE-S-38-1 1/2"-NPT-SC	443,33



T-Einschraubverschraubungsstutzen
LL-, L- und S-Reihe
Einschraubgewinde: NPT

Stud Branch Tee Bodies
LL-, L- and S-Series
Thread: NPT

Reihe Series	Druck Pressure PN	Rohr A.D. Tube O.D. D1	Gewinde Thread G	Ca. Maße Approx. Dimensions					Bestellzeichen Order-Code OMD	Brutto-Preis Gross-Price Euro (€)
LL	100	4	1/8" NPT						TE-LL-04-1/8"-NPT-OMD	*
LL	100	6	1/8" NPT						TE-LL-06-1/8"-NPT-OMD	22,30
LL	100	8	1/8" NPT						TE-LL-08-1/8"-NPT-OMD	22,14

Reihe Series	Druck Pressure PN	Rohr A.D. Tube O.D. D1	Gewinde Thread G	Ca. Maße Approx. Dimensions					Bestellzeichen Order-Code OMD	Brutto-Preis Gross-Price Euro (€)
L	315	6	1/8" NPT						TE-L-06-1/8"-NPT-OMD	25,55
L	315	6	1/4" NPT						TE-L-06-1/4"-NPT-OMD	27,08
L	315	8	1/4" NPT						TE-L-08-1/4"-NPT-OMD	26,33
L	315	10	1/4" NPT						TE-L-10-1/4"-NPT-OMD	28,56
L	315	10	3/8" NPT						TE-L-10-3/8"-NPT-OMD	35,46
L	315	10	1/2" NPT						TE-L-10-1/2"-NPT-OMD	37,66
L	315	12	1/4" NPT						TE-L-12-1/4"-NPT-OMD	34,79
L	315	12	3/8" NPT						TE-L-12-3/8"-NPT-OMD	34,79
L	315	12	1/2" NPT						TE-L-12-1/2"-NPT-OMD	36,96
L	315	15	3/8" NPT						TE-L-15-3/8"-NPT-OMD	*
L	315	15	1/2" NPT						TE-L-15-1/2"-NPT-OMD	48,26
L	315	18	1/2" NPT						TE-L-18-1/2"-NPT-OMD	77,35
L	160	22	3/4" NPT						TE-L-22-3/4"-NPT-OMD	79,08
L	160	28	1" NPT						TE-L-28-1"-NPT-OMD	133,92
L	160	35	1 1/4" NPT						TE-L-35-1 1/4"-NPT-OMD	267,12
L	160	42	1 1/2" NPT						TE-L-42-1 1/2"-NPT-OMD	262,15

Reihe Series	Druck Pressure PN	Rohr A.D. Tube O.D. D1	Gewinde Thread G	Ca. Maße Approx. Dimensions					Bestellzeichen Order-Code OMD	Brutto-Preis Gross-Price Euro (€)
S	630	6	1/4" NPT						TE-S-06-1/4"-NPT-OMD	27,30
S	630	8	1/4" NPT						TE-S-08-1/4"-NPT-OMD	27,19
S	630	10	1/4" NPT						TE-S-10-1/4"-NPT-OMD	*
S	630	10	3/8" NPT						TE-S-10-3/8"-NPT-OMD	33,10
S	630	10	1/2" NPT						TE-S-10-1/2"-NPT-OMD	*
S	630	12	1/4" NPT						TE-S-12-1/4"-NPT-OMD	*
S	630	12	3/8" NPT						TE-S-12-3/8"-NPT-OMD	39,03
S	630	12	1/2" NPT						TE-S-12-1/2"-NPT-OMD	55,90
S	630	14	1/2" NPT						TE-S-14-1/2"-NPT-OMD	47,80
S	400	16	1/2" NPT						TE-S-16-1/2"-NPT-OMD	75,61
S	400	20	3/4" NPT						TE-S-20-3/4"-NPT-OMD	91,33
S	400	25	1" NPT						TE-S-25-1"-NPT-OMD	136,60
S	400	30	1 1/4" NPT						TE-S-30-1 1/4"-NPT-OMD	185,76
S	315	38	1 1/2" NPT						TE-S-38-1 1/2"-NPT-OMD	368,77

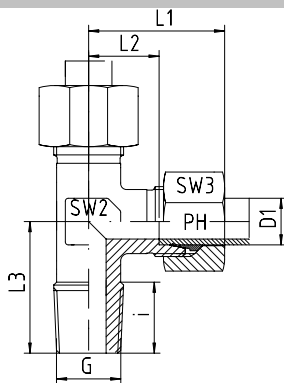

L-Einschraubverschraubungen
LL-, L- und S-Reihe
Einschraubgewinde: Whitworth-Rohrgewinde - Kegelig

Stud Barrel Tees
LL-, L- and S-Series
Thread: BSP - Taper

Reihe Series	Druck Pressure PN	Rohr A.D. Tube O.D. D1	Gewinde Thread G	Ca. Maße Approx. Dimensions						Bestellzeichen Order-Code Standard	Brutto-Preis Gross-Price Euro (€)
				L1	L2	L3	i	SW2	SW3		
LL	100	4	R 1/8" keg	21	11,0	17	8	9	10	LE-LL-04-R 1/8"-k	28,45
LL	100	6	R 1/8" keg	21	9,5	17	8	9	12	LE-LL-06-R 1/8"-k	29,25
LL	100	8	R 1/8" keg	23	11,5	20	8	12	14	LE-LL-08-R 1/8"-k	32,20

Reihe Series	Druck Pressure PN	Rohr A.D. Tube O.D. D1	Gewinde Thread G	Ca. Maße Approx. Dimensions						Bestellzeichen Order-Code Standard	Brutto-Preis Gross-Price Euro (€)
				L1	L2	L3	i	SW2	SW3		
L	315	6	R 1/8" keg	27	12,0	20	8	12	14	LE-L-06-R 1/8"-k	24,29
L	315	6	R 1/4" keg	27	12,0	26	12	12	14	LE-L-06-R 1/4"-k	28,12
L	315	8	R 1/4" keg	29	14,0	26	12	12	17	LE-L-08-R 1/4"-k	28,33
L	315	8	R 3/8" keg	32	17,0	28	12	14	17	LE-L-08-R 3/8"-k	*
L	315	10	R 1/8" keg				8	14	19	LE-L-10-R 1/8"-k	*
L	315	10	R 1/4" keg	30	15,0	27	12	14	19	LE-L-10-R 1/4"-k	31,06
L	315	10	R 3/8" keg	30	15,0	28	12	17	19	LE-L-10-R 3/8"-k	34,51
L	315	10	R 1/2" keg				14	17	19	LE-L-10-R 1/2"-k	*
L	315	12	R 1/4" keg	32	17,5	27	12	17	22	LE-L-12-R 1/4"-k	34,79
L	315	12	R 3/8" keg	32	17,5	28	12	17	22	LE-L-12-R 3/8"-k	34,79
L	315	12	R 1/2" keg				14	17	22	LE-L-12-R 1/2"-k	38,25
L	315	15	R 3/8" keg				12	19	27	LE-L-15-R 3/8"-k	*
L	315	15	R 1/2" keg	36	21,0	34	14	19	27	LE-L-15-R 1/2"-k	47,53
L	315	18	R 1/2" keg	40	23,5	36	14	24	32	LE-L-18-R 1/2"-k	69,03

Reihe Series	Druck Pressure PN ⁽¹⁾	Rohr A.D. Tube O.D. D1	Gewinde Thread G	Ca. Maße Approx. Dimensions						Bestellzeichen Order-Code Standard	Brutto-Preis Gross-Price Euro (€)
				L1	L2	L3	i	SW2	SW3		
S	630	6	R 1/4" keg	31	16,5	26	12	12	17	LE-S-06-R 1/4"-k	28,63
S	630	8	R 1/4" keg	32	17,0	27	12	14	19	LE-S-08-R 1/4"-k	31,19
S	630	10	R 3/8" keg	34	17,5	28	12	17	22	LE-S-10-R 3/8"-k	35,05
S	630	12	R 3/8" keg	38	21,5	28	12	17	24	LE-S-12-R 3/8"-k	44,43
S	630	12	R 1/2" keg	38	21,5	33	14	19	24	LE-S-12-R 1/2"-k	58,80
S	630	14	R 1/2" keg	40	22,0	32	14	19	27	LE-S-14-R 1/2"-k	49,93
S	400	16	R 1/2" keg	43	24,5	32	14	24	30	LE-S-16-R 1/2"-k	69,03

⁽¹⁾ Die angegebenen Druckstufen sind nur gültig, wenn die Einschraublöcher mit kegeligem Gewinde vorhanden sind.

⁽¹⁾ The pressure rates are only valid, if the female parts are with tapered threads, too.

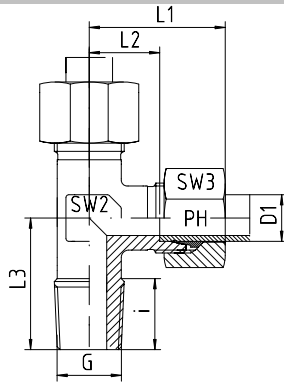

L-Einschraubverschraubungen
L- und S-Reihe
Einschraubgewinde: Whitworth-Rohrgewinde - Kegelig

Stud Barrel Tees
L- and S-Series
Thread: BSP - Taper

Reihe Series	Druck Pressure PN	Rohr A.D. Tube O.D. D1	Gewinde Thread G	Ca. Maße Approx. Dimensions						Bestellzeichen Order-Code SC	Brutto-Preis Gross-Price Euro (€)
				L1	L2	L3	i	SW2	SW3		
L	315	6	R 1/8" keg	27	12,0	20	8	12	14	LE-L-06-R 1/8"-k-SC	24,93
L	315	6	R 1/4" keg	27	12,0	26	12	12	14	LE-L-06-R 1/4"-k-SC	28,76
L	315	8	R 1/4" keg	29	14,0	26	12	12	17	LE-L-08-R 1/4"-k-SC	29,21
L	315	8	R 3/8" keg	32	17,0	28	12	14	17	LE-L-08-R 3/8"-k-SC	*
L	315	10	R 1/8" keg				8	14	19	LE-L-10-R 1/8"-k-SC	*
L	315	10	R 1/4" keg	30	15,0	27	12	14	19	LE-L-10-R 1/4"-k-SC	31,94
L	315	10	R 3/8" keg	30	15,0	28	12	17	19	LE-L-10-R 3/8"-k-SC	35,39
L	315	10	R 1/2" keg				14	17	19	LE-L-10-R 1/2"-k-SC	*
L	315	12	R 1/4" keg	32	17,5	27	12	17	22	LE-L-12-R 1/4"-k-SC	35,91
L	315	12	R 3/8" keg	32	17,5	28	12	17	22	LE-L-12-R 3/8"-k-SC	35,91
L	315	12	R 1/2" keg				14	17	22	LE-L-12-R 1/2"-k-SC	39,37
L	315	15	R 3/8" keg				12	19	27	LE-L-15-R 3/8"-k-SC	*
L	315	15	R 1/2" keg	36	21,0	34	14	19	27	LE-L-15-R 1/2"-k-SC	49,69
L	315	18	R 1/2" keg	40	23,5	36	14	24	32	LE-L-18-R 1/2"-k-SC	72,31

Reihe Series	Druck Pressure PN ⁽¹⁾	Rohr A.D. Tube O.D. D1	Gewinde Thread G	Ca. Maße Approx. Dimensions						Bestellzeichen Order-Code SC	Brutto-Preis Gross-Price Euro (€)
				L1	L2	L3	i	SW2	SW3		
S	630	6	R 1/4" keg	31	16,5	26	12	12	17	LE-S-06-R 1/4"-k-SC	29,51
S	630	8	R 1/4" keg	32	17,0	27	12	14	19	LE-S-08-R 1/4"-k-SC	32,07
S	630	10	R 3/8" keg	34	17,5	28	12	17	22	LE-S-10-R 3/8"-k-SC	36,17
S	630	12	R 3/8" keg	38	21,5	28	12	17	24	LE-S-12-R 3/8"-k-SC	46,11
S	630	12	R 1/2" keg	38	21,5	33	14	19	24	LE-S-12-R 1/2"-k-SC	60,48
S	630	14	R 1/2" keg	40	22,0	32	14	19	27	LE-S-14-R 1/2"-k-SC	53,05
S	400	16	R 1/2" keg	43	24,5	32	14	24	30	LE-S-16-R 1/2"-k-SC	72,15

⁽¹⁾ Die angegebenen Druckstufen sind nur gültig, wenn die Einschraublöcher mit kegeligem Gewinde vorhanden sind.

⁽¹⁾ The pressure rates are only valid, if the female parts are with tapered threads, too.



L-Einschraubverschraubungsstutzen
LL-, L- und S-Reihe
Einschraubgewinde: Whitworth-Rohrgewinde - Kegelig

Stud Barrel Tee Bodies
LL-, L- and S-Series
Thread: BSP - Taper

Reihe Series	Druck Pressure PN	Rohr A.D. Tube O.D. D1	Gewinde Thread G	Ca. Maße Approx. Dimensions					Bestellzeichen Order-Code OMD	Brutto-Preis Gross-Price Euro (€)
LL	100	4	R 1/8"-keg						LE-LL-04-R 1/8"-k-OMD	23,13
LL	100	6	R 1/8" keg						LE-LL-06-R 1/8"-k-OMD	23,17
LL	100	8	R 1/8" keg						LE-LL-08-R 1/8"-k-OMD	25,20

Reihe Series	Druck Pressure PN	Rohr A.D. Tube O.D. D1	Gewinde Thread G	Ca. Maße Approx. Dimensions					Bestellzeichen Order-Code OMD	Brutto-Preis Gross-Price Euro (€)
L	315	6	R 1/8" keg						LE-L-06-R 1/8"-k-OMD	19,67
L	315	6	R 1/4" keg						LE-L-06-R 1/4"-k-OMD	23,50
L	315	8	R 1/4" keg						LE-L-08-R 1/4"-k-OMD	22,73
L	315	8	R 3/8" keg						LE-L-08-R 3/8"-k-OMD	*
L	315	10	R 1/8" keg						LE-L-10-R 1/8"-k-OMD	*
L	315	10	R 1/4" keg						LE-L-10-R 1/4"-k-OMD	24,34
L	315	10	R 3/8" keg						LE-L-10-R 3/8"-k-OMD	27,79
L	315	10	R 1/2" keg						LE-L-10-R 1/2"-k-OMD	*
L	315	12	R 1/4" keg						LE-L-12-R 1/4"-k-OMD	27,01
L	315	12	R 3/8" keg						LE-L-12-R 3/8"-k-OMD	27,01
L	315	12	R 1/2" keg						LE-L-12-R 1/2"-k-OMD	30,47
L	315	15	R 3/8" keg						LE-L-15-R 3/8"-k-OMD	*
L	315	15	R 1/2" keg						LE-L-15-R 1/2"-k-OMD	37,25
L	315	18	R 1/2" keg						LE-L-18-R 1/2"-k-OMD	51,79

Reihe Series	Druck Pressure PN ⁽¹⁾	Rohr A.D. Tube O.D. D1	Gewinde Thread G	Ca. Maße Approx. Dimensions					Bestellzeichen Order-Code OMD	Brutto-Preis Gross-Price Euro (€)
S	630	6	R 1/4" keg						LE-S-06-R 1/4"-k-OMD	23,05
S	630	8	R 1/4" keg						LE-S-08-R 1/4"-k-OMD	24,79
S	630	10	R 3/8" keg						LE-S-10-R 3/8"-k-OMD	27,17
S	630	12	R 3/8" keg						LE-S-12-R 3/8"-k-OMD	35,53
S	630	12	R 1/2" keg						LE-S-12-R 1/2"-k-OMD	49,90
S	630	14	R 1/2" keg						LE-S-14-R 1/2"-k-OMD	38,93
S	400	16	R 1/2" keg						LE-S-16-R 1/2"-k-OMD	52,61

⁽¹⁾ Die angegebenen Druckstufen sind nur gültig, wenn die Einschraublöcher mit kegeligem Gewinde vorhanden sind.

⁽¹⁾ The pressure rates are only valid, if the female parts are with tapered threads, too.

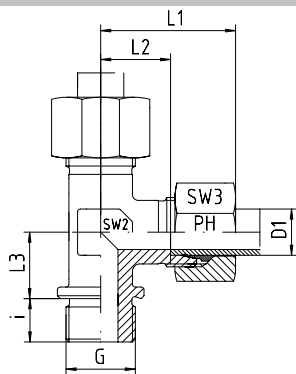

L-Einschraubverschraubungen
L- und S-Reihe
Einschraubgewinde: Whitworth-Rohrgewinde - Zylindrisch
Abdichtung durch Dichtkante Form B

Stud Barrel Tees
L- and S-Series
Thread: BSP - Parallel
Sealing by Sealing Shoulder Form B

Reihe Series	Druck Pressure PN	Rohr A.D. Tube O.D. D1	Gewinde Thread G	Ca. Maße Approx. Dimensions						Bestellzeichen Order-Code Standard	Brutto-Preis Gross-Price Euro (€)
				L1	L2	L3	i	SW2	SW3		
L	160	22	G 3/4" zyl	44	27,5	26	16	27	36	LE-L-22-R 3/4"-z	87,43
L	160	28	G 1" zyl	47	30,5	30	18	36	41	LE-L-28-R 1"-z	144,70
L	160	35	G 1 1/4" zyl	56	34,5	34	20	41	50	LE-L-35-R 1 1/4"-z	269,45
L	160	42	G 1 1/2" zyl	63	40,0	39	22	50	60	LE-L-42-R 1 1/2"-z	281,21

Reihe Series	Druck Pressure PN	Rohr A.D. Tube O.D. D1	Gewinde Thread G	Ca. Maße Approx. Dimensions						Bestellzeichen Order-Code Standard	Brutto-Preis Gross-Price Euro (€)
				L1	L2	L3	i	SW2	SW3		
S	400	20	G 3/4" zyl	48	26,5	26	16	27	36	LE-S-20-R 3/4"-z	87,43
S	250	25	G 1" zyl	54	30,0	30	18	36	46	LE-S-25-R 1"-z	152,88
S	160	30	G 1 1/4" zyl	62	35,5	34	20	41	50	LE-S-30-R 1 1/4"-z	204,52
S	160	38	G 1 1/2" zyl	72	41,0	39	22	50	60	LE-S-38-R 1 1/2"-z	375,81

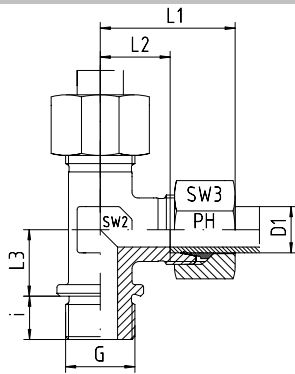

L-Einschraubverschraubungen

L- und S-Reihe

Einschraubgewinde: Whitworth-Rohrgewinde - Zylindrisch
 Abdichtung durch Dichtkante Form B

Stud Barrel Tees

L- and S-Series

Thread: BSP - Parallel

Sealing by Sealing Shoulder Form B

Reihe Series	Druck Pressure PN	Rohr A.D. Tube O.D. D1	Gewinde Thread G	Ca. Maße Approx. Dimensions						Bestellzeichen Order-Code SC	Brutto-Preis Gross-Price Euro (€)
				L1	L2	L3	i	SW2	SW3		
L	160	22	G 3/4" zyl	44	27,5	26	16	27	36	LE-L-22-R 3/4"-z-SC	90,95
L	160	28	G 1" zyl	47	30,5	30	18	36	41	LE-L-28-R 1"-z-SC	148,70
L	160	35	G 1 1/4" zyl	56	34,5	34	20	41	50	LE-L-35-R 1 1/4"-z-SC	276,89
L	160	42	G 1 1/2" zyl	63	40,0	39	22	50	60	LE-L-42-R 1 1/2"-z-SC	289,85

Reihe Series	Druck Pressure PN	Rohr A.D. Tube O.D. D1	Gewinde Thread G	Ca. Maße Approx. Dimensions						Bestellzeichen Order-Code SC	Brutto-Preis Gross-Price Euro (€)
				L1	L2	L3	i	SW2	SW3		
S	400	20	G 3/4" zyl	48	26,5	26	16	27	36	LE-S-20-R 3/4"-z-SC	91,19
S	250	25	G 1" zyl	54	30,0	30	18	36	46	LE-S-25-R 1"-z-SC	158,88
S	160	30	G 1 1/4" zyl	62	35,5	34	20	41	50	LE-S-30-R 1 1/4"-z-SC	212,84
S	160	38	G 1 1/2" zyl	72	41,0	39	22	50	60	LE-S-38-R 1 1/2"-z-SC	387,09



L-Einschraubverschraubungsstutzen

L- und S-Reihe

Einschraubgewinde: Whitworth-Rohrgewinde - Zylindrisch
Abdichtung durch Dichtkante Form B

Stud Barrel Tee Bodies

L- and S-Series

Thread: BSP - Parallel

Sealing by Sealing Shoulder Form B

Reihe Series	Druck Pressure PN	Rohr A.D. Tube O.D. D1	Gewinde Thread G	Ca. Maße Approx. Dimensions						Bestellzeichen Order-Code OMD	Brutto-Preis Gross-Price Euro (€)
L	160	22	G 3/4" zyl							LE-L-22-R 3/4"-z-OMD	66,81
L	160	28	G 1" zyl							LE-L-28-R 1"-z-OMD	115,00
L	160	35	G 1 1/4" zyl							LE-L-35-R 1 1/4"-z-OMD	227,23
L	160	42	G 1 1/2" zyl							LE-L-42-R 1 1/2"-z-OMD	226,35

Reihe Series	Druck Pressure PN	Rohr A.D. Tube O.D. D1	Gewinde Thread G	Ca. Maße Approx. Dimensions						Bestellzeichen Order-Code OMD	Brutto-Preis Gross-Price Euro (€)
S	400	20	G 3/4" zyl							LE-S-20-R 3/4"-z-OMD	66,27
S	250	25	G 1" zyl							LE-S-25-R 1"-z-OMD	115,64
S	160	30	G 1 1/4" zyl							LE-S-30-R 1 1/4"-z-OMD	157,64
S	160	38	G 1 1/2" zyl							LE-S-38-R 1 1/2"-z-OMD	312,53

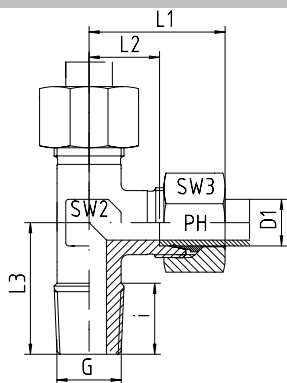

L-Einschraubverschraubungen
LL-, L- und S-Reihe
Einschraubgewinde: Metrisches Feingewinde - Kegelig

Stud Barrel Tees
LL-, L- and S-Series
Thread: Metric - Taper

Reihe Series	Druck Pressure PN	Rohr A.D. Tube O.D. D1	Gewinde Thread G	Ca. Maße Approx. Dimensions						Bestellzeichen Order-Code Standard	Brutto-Preis Gross-Price Euro (€)
				L1	L2	L3	i	SW2	SW3		
LL	100	4	M 6 x 1 keg	21	11,0	17	8	9	10	LE-LL-04-M 6x1-k	*
LL	100	4	M 8 x 1 keg	21	11,0	17	8	9	10	LE-LL-04-M 8x1-k	*
LL	100	6	M 6 x 1 keg				8	9	12	LE-LL-06-M 6x1-k	*
LL	100	6	M 8 x 1 keg				8	9	12	LE-LL-06-M 8x1-k	*
LL	100	6	M 10 x 1 keg	21	9,5	17	8	9	12	LE-LL-06-M 10x1-k	*
LL	100	8	M 8 x 1 keg				8	12	14	LE-LL-08-M 8x1-k	*
LL	100	8	M 10 x 1 keg	23	11,5	20	8	12	14	LE-LL-08-M 10x1-k	*

Reihe Series	Druck Pressure PN	Rohr A.D. Tube O.D. D1	Gewinde Thread G	Ca. Maße Approx. Dimensions						Bestellzeichen Order-Code Standard	Brutto-Preis Gross-Price Euro (€)
				L1	L2	L3	i	SW2	SW3		
L	315	6	M 10 x 1 keg	27	12,0	20	8	12	14	LE-L-06-M 10x1-k	26,59
L	315	8	M 12 x 1,5 keg	29	14,0	26	12	12	17	LE-L-08-M 12x1,5-k	28,68
L	315	10	M 14 x 1,5 keg	30	15,0	27	12	14	19	LE-L-10-M 14x1,5-k	31,70
L	315	12	M 16 x 1,5 keg	32	17,0	28	12	17	22	LE-L-12-M 16x1,5-k	37,04
L	315	15	M 18 x 1,5 keg	36	21,0	32	12	19	27	LE-L-15-M 18x1,5-k	50,77
L	315	18	M 22 x 1,5 keg	40	23,0	36	14	24	32	LE-L-18-M 22x1,5-k	81,81

Reihe Series	Druck Pressure PN ⁽¹⁾	Rohr A.D. Tube O.D. D1	Gewinde Thread G	Ca. Maße Approx. Dimensions						Bestellzeichen Order-Code Standard	Brutto-Preis Gross-Price Euro (€)
				L1	L2	L3	i	SW2	SW3		
S	630	6	M 12 x 1,5 keg	31	16,0	26	12	12	17	LE-S-06-M 12x1,5-k	28,20
S	630	8	M 14 x 1,5 keg	32	17,0	27	12	14	19	LE-S-08-M 14x1,5-k	31,19
S	630	10	M 16 x 1,5 keg	34	17,5	28	12	17	22	LE-S-10-M 16x1,5-k	36,94
S	630	12	M 18 x 1,5 keg	38	21,5	28	12	17	24	LE-S-12-M 18x1,5-k	41,82
S	630	14	M 20 x 1,5 keg	40	22,0	32	14	19	27	LE-S-14-M 20x1,5-k	51,59
S	400	16	M 22 x 1,5 keg	43	24,5	32	14	24	30	LE-S-16-M 22x1,5-k	79,25

⁽¹⁾ Die angegebenen Druckstufen sind nur gültig, wenn die Einschraublöcher mit kegeligem Gewinde vorhanden sind.
⁽¹⁾ The pressure rates are only valid, if the female parts are with tapered threads, too.

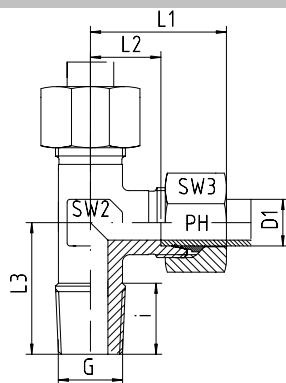

L-Einschraubverschraubungen
L- und S-Reihe
Einschraubgewinde: Metrisches Feingewinde - Kegelig

Stud Barrel Tees
L- and S-Series
Thread: Metric - Taper

Reihe Series	Druck Pressure PN	Rohr A.D. Tube O.D. D1	Gewinde Thread G	Ca. Maße Approx. Dimensions						Bestellzeichen Order-Code SC	Brutto-Preis Gross-Price Euro (€)
				L1	L2	L3	i	SW2	SW3		
L	315	6	M 10 x 1 keg	27	12,0	20	8	12	14	LE-L-06-M 10x1-k-SC	27,23
L	315	8	M 12 x 1,5 keg	29	14,0	26	12	12	17	LE-L-08-M 12x1,5-k-SC	29,56
L	315	10	M 14 x 1,5 keg	30	15,0	27	12	14	19	LE-L-10-M 14x1,5-k-SC	32,58
L	315	12	M 16 x 1,5 keg	32	17,0	28	12	17	22	LE-L-12-M 16x1,5-k-SC	38,16
L	315	15	M 18 x 1,5 keg	36	21,0	32	12	19	27	LE-L-15-M 18x1,5-k-SC	52,93
L	315	18	M 22 x 1,5 keg	40	23,0	36	14	24	32	LE-L-18-M 22x1,5-k-SC	85,09

Reihe Series	Druck Pressure PN ⁽¹⁾	Rohr A.D. Tube O.D. D1	Gewinde Thread G	Ca. Maße Approx. Dimensions						Bestellzeichen Order-Code SC	Brutto-Preis Gross-Price Euro (€)
				L1	L2	L3	i	SW2	SW3		
S	630	6	M 12 x 1,5 keg	31	16,0	26	12	12	17	LE-S-06-M 12x1,5-k-SC	29,08
S	630	8	M 14 x 1,5 keg	32	17,0	27	12	14	19	LE-S-08-M 14x1,5-k-SC	32,07
S	630	10	M 16 x 1,5 keg	34	17,5	28	12	17	22	LE-S-10-M 16x1,5-k-SC	38,06
S	630	12	M 18 x 1,5 keg	38	21,5	28	12	17	24	LE-S-12-M 18x1,5-k-SC	43,50
S	630	14	M 20 x 1,5 keg	40	22,0	32	14	19	27	LE-S-14-M 20x1,5-k-SC	54,71
S	400	16	M 22 x 1,5 keg	43	24,5	32	14	24	30	LE-S-16-M 22x1,5-k-SC	82,37

⁽¹⁾ Die angegebenen Druckstufen sind nur gültig, wenn die Einschraublöcher mit kegeligem Gewinde vorhanden sind.

⁽¹⁾ The pressure rates are only valid, if the female parts are with tapered threads, too.



L-Einschraubverschraubungsstutzen
LL-, L- und S-Reihe
Einschraubgewinde: Metrisches Feingewinde - Kegelig

Stud Barrel Tee Bodies
LL-, L- and S-Series
Thread: Metric - Taper

Reihe Series	Druck Pressure PN	Rohr A.D. Tube O.D. D1	Gewinde Thread G	Ca. Maße Approx. Dimensions					Bestellzeichen Order-Code OMD	Brutto-Preis Gross-Price Euro (€)
LL	100	4	M 6 x 1 keg						LE-LL-04-M 6x1-k-OMD	*
LL	100	4	M 8 x 1 keg						LE-LL-04-M 8x1-k-OMD	*
LL	100	6	M 6 x 1 keg						LE-LL-06-M 6x1-k-OMD	*
LL	100	6	M 8 x 1 keg						LE-LL-06-M 8x1-k-OMD	*
LL	100	6	M 10 x 1 keg						LE-LL-06-M 10x1-k-OMD	*
LL	100	8	M 8 x 1 keg						LE-LL-08-M 8x1-k-OMD	*
LL	100	8	M 10 x 1 keg						LE-LL-08-M 10x1-k-OMD	*

Reihe Series	Druck Pressure PN	Rohr A.D. Tube O.D. D1	Gewinde Thread G	Ca. Maße Approx. Dimensions					Bestellzeichen Order-Code OMD	Brutto-Preis Gross-Price Euro (€)
L	315	6	M 10 x 1 keg						LE-L-06-M 10x1-k-OMD	21,97
L	315	8	M 12 x 1,5 keg						LE-L-08-M 12x1,5-k-OMD	23,08
L	315	10	M 14 x 1,5 keg						LE-L-10-M 14x1,5-k-OMD	24,98
L	315	12	M 16 x 1,5 keg						LE-L-12-M 16x1,5-k-OMD	29,26
L	315	15	M 18 x 1,5 keg						LE-L-15-M 18x1,5-k-OMD	40,49
L	315	18	M 22 x 1,5 keg						LE-L-18-M 22x1,5-k-OMD	64,57

Reihe Series	Druck Pressure PN ⁽¹⁾	Rohr A.D. Tube O.D. D1	Gewinde Thread G	Ca. Maße Approx. Dimensions					Bestellzeichen Order-Code OMD	Brutto-Preis Gross-Price Euro (€)
S	630	6	M 12 x 1,5 keg						LE-S-06-M 12x1,5-k-OMD	22,62
S	630	8	M 14 x 1,5 keg						LE-S-08-M 14x1,5-k-OMD	24,79
S	630	10	M 16 x 1,5 keg						LE-S-10-M 16x1,5-k-OMD	29,06
S	630	12	M 18 x 1,5 keg						LE-S-12-M 18x1,5-k-OMD	32,92
S	630	14	M 20 x 1,5 keg						LE-S-14-M 20x1,5-k-OMD	40,59
S	400	16	M 22 x 1,5 keg						LE-S-16-M 22x1,5-k-OMD	62,83

⁽¹⁾ Die angegebenen Druckstufen sind nur gültig, wenn die Einschraublöcher mit kegeligem Gewinde vorhanden sind.

⁽¹⁾ The pressure rates are only valid, if the female parts are with tapered threads, too.

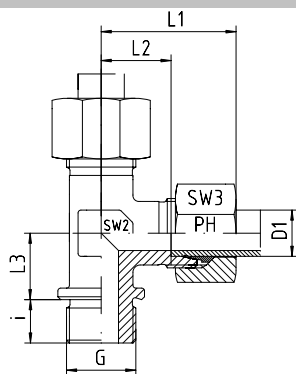

L-Einschraubverschraubungen
L- und S-Reihe
Einschraubgewinde: Metrisches Feingewinde - Zylindrisch
Abdichtung durch Dichtkante Form B

Stud Barrel Tees
L- and S-Series
Thread: Metric - Parallel
Sealing by Sealing Shoulder Form B

Reihe Series	Druck Pressure PN	Rohr A.D. Tube O.D. D1	Gewinde Thread G	Ca. Maße Approx. Dimensions						Bestellzeichen Order-Code Standard	Brutto-Preis Gross-Price Euro (€)
				L1	L2	L3	i	SW2	SW3		
L	160	22	M 26 x 1,5 zyl	44	27,5	26	16	27	36	LE-L-22-M 26x1,5-z	87,94
L	160	28	M 33 x 2 zyl	47	30,5	30	18	36	41	LE-L-28-M 33x2-z	143,93
L	160	35	M 42 x 2 zyl	56	34,5	34	20	41	50	LE-L-35-M 42x2-z	272,52
L	160	42	M 48 x 2 zyl	63	40,0	39	22	50	60	LE-L-42-M 48x2-z	279,68

Reihe Series	Druck Pressure PN	Rohr A.D. Tube O.D. D1	Gewinde Thread G	Ca. Maße Approx. Dimensions						Bestellzeichen Order-Code Standard	Brutto-Preis Gross-Price Euro (€)
				L1	L2	L3	i	SW2	SW3		
S	400	20	M 27 x 2 zyl	48	26,5	26	16	27	36	LE-S-20-M 27x2-z	87,94
S	250	25	M 33 x 2 zyl	54	30,0	30	18	36	46	LE-S-25-M 33x2-z	152,88
S	160	30	M 42 x 2 zyl	62	35,5	34	20	41	50	LE-S-30-M 42x2-z	202,47
S	160	38	M 48 x 2 zyl	72	41,0	39	22	50	60	LE-S-38-M 48x2-z	378,36

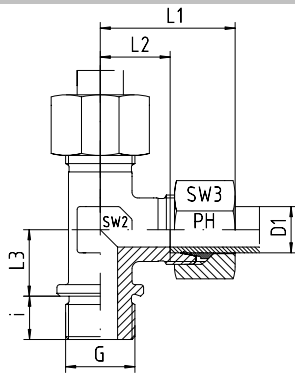

L-Einschraubverschraubungen

L- und S-Reihe

Einschraubgewinde: Metrisches Feingewinde - Zylindrisch
Abdichtung durch Dichtkante Form B

Stud Barrel Tees

L- and S-Series

Thread: Metric - Parallel

Sealing by Sealing Shoulder Form B

Reihe Series	Druck Pressure PN	Rohr A.D. Tube O.D. D1	Gewinde Thread G	Ca. Maße Approx. Dimensions						Bestellzeichen Order-Code SC	Brutto-Preis Gross-Price Euro (€)
				L1	L2	L3	i	SW2	SW3		
L	160	22	M 26 x 1,5 zyl	44	27,5	26	16	27	36	LE-L-22-M 26x1,5-z-SC	91,46
L	160	28	M 33 x 2 zyl	47	30,5	30	18	36	41	LE-L-28-M 33x2-z-SC	147,93
L	160	35	M 42 x 2 zyl	56	34,5	34	20	41	50	LE-L-35-M 42x2-z-SC	279,96
L	160	42	M 48 x 2 zyl	63	40,0	39	22	50	60	LE-L-42-M 48x2-z-SC	288,32

Reihe Series	Druck Pressure PN	Rohr A.D. Tube O.D. D1	Gewinde Thread G	Ca. Maße Approx. Dimensions						Bestellzeichen Order-Code SC	Brutto-Preis Gross-Price Euro (€)
				L1	L2	L3	i	SW2	SW3		
S	400	20	M 27 x 2 zyl	48	26,5	26	16	27	36	LE-S-20-M 27x2-z-SC	91,70
S	250	25	M 33 x 2 zyl	54	30,0	30	18	36	46	LE-S-25-M 33x2-z-SC	158,88
S	160	30	M 42 x 2 zyl	62	35,5	34	20	41	50	LE-S-30-M 42x2-z-SC	210,79
S	160	38	M 48 x 2 zyl	72	41,0	39	22	50	60	LE-S-38-M 48x2-z-SC	389,64



L-Einschraubverschraubungssutzen

L- und S-Reihe

Einschraubgewinde: Metrisches Feingewinde - Zylindrisch
Abdichtung durch Dichtkante Form B

Stud Barrel Tee Bodies

L- and S-Series

Thread: Metric - Parallel

Sealing by Sealing Shoulder Form B

Reihe Series	Druck Pressure PN	Rohr A.D. Tube O.D. D1	Gewinde Thread G	Ca. Maße Approx. Dimensions						Bestellzeichen Order-Code OMD	Brutto-Preis Gross-Price Euro (€)
L	160	22	M 26 x 1,5 zyl							LE-L-22-M 26x1,5-z-OMD	67,32
L	160	28	M 33 x 2 zyl							LE-L-28-M 33x2-z-OMD	114,23
L	160	35	M 42 x 2 zyl							LE-L-35-M 42x2-z-OMD	230,30
L	160	42	M 48 x 2 zyl							LE-L-42-M 48x2-z-OMD	224,82

Reihe Series	Druck Pressure PN	Rohr A.D. Tube O.D. D1	Gewinde Thread G	Ca. Maße Approx. Dimensions						Bestellzeichen Order-Code OMD	Brutto-Preis Gross-Price Euro (€)
S	400	20	M 27 x 2 zyl							LE-S-20-M 27x2-z-OMD	66,78
S	250	25	M 33 x 2 zyl							LE-S-25-M 33x2-z-OMD	115,64
S	160	30	M 42 x 2 zyl							LE-S-30-M 42x2-z-OMD	155,59
S	160	38	M 48 x 2 zyl							LE-S-38-M 48x2-z-OMD	315,08

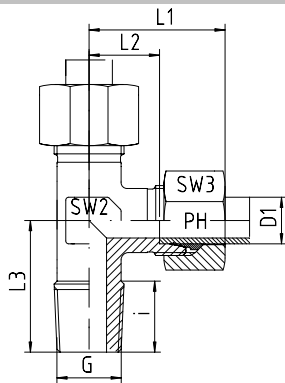

L-Einschraubverschraubungen
LL-, L- und S-Reihe
Einschraubgewinde: NPT

Stud Barrel Tees
LL-, L- and S-Series
Thread: NPT

Reihe Series	Druck Pressure PN	Rohr A.D. Tube O.D. D1	Gewinde Thread G	Ca. Maße Approx. Dimensions						Bestellzeichen Order-Code Standard	Brutto-Preis Gross-Price Euro (€)
				L1	L2	L3	i	SW2	SW3		
LL	100	4	1/8" NPT	21	11,0	17	10,0	9	10	LE-LL-04-1/8"-NPT	*
LL	100	6	1/8" NPT	21	9,5	17	10,0	9	14	LE-LL-06-1/8"-NPT	*
LL	100	8	1/8" NPT	23	11,5	20	10,0	12	17	LE-LL-08-1/8"-NPT	*

Reihe Series	Druck Pressure PN	Rohr A.D. Tube O.D. D1	Gewinde Thread G	Ca. Maße Approx. Dimensions						Bestellzeichen Order-Code Standard	Brutto-Preis Gross-Price Euro (€)
				L1	L2	L3	i	SW2	SW3		
L	315	6	1/8" NPT	27	12,0	20	10,0	12	14	LE-L-06-1/8"-NPT	30,17
L	315	6	1/4" NPT	29	14,0	26	15,0	12	14	LE-L-06-1/4"-NPT	30,63
L	315	8	1/4" NPT	29	14,0	26	15,0	12	17	LE-L-08-1/4"-NPT	31,93
L	315	10	1/4" NPT	30	15,0	27	15,0	14	19	LE-L-10-1/4"-NPT	35,28
L	315	10	3/8" NPT				15,3	17	19	LE-L-10-3/8"-NPT	*
L	315	10	1/2" NPT				20,0	17	19	LE-L-10-1/2"-NPT	*
L	315	12	1/4" NPT	32	17,0	28	15,0	17	22	LE-L-12-1/4"-NPT	44,43
L	315	12	3/8" NPT	32	17,0	28	15,3	17	22	LE-L-12-3/8"-NPT	42,57
L	315	12	1/2" NPT				20,0	17	22	LE-L-12-1/2"-NPT	45,97
L	315	15	3/8" NPT				15,3	19	27	LE-L-15-3/8"-NPT	*
L	315	15	1/2" NPT	36	21,0	34	20,0	19	27	LE-L-15-1/2"-NPT	58,54
L	315	18	1/2" NPT	40	23,5	36	20,0	24	32	LE-L-18-1/2"-NPT	94,59
L	160	22	3/4" NPT	44	27,5	42	20,0	27	36	LE-L-22-3/4"-NPT	99,70
L	160	28	1" NPT	47	30,5	48	25,0	36	41	LE-L-28-1"-NPT	163,62
L	160	35	1 1/4" NPT	56	34,5	54	25,5	41	50	LE-L-35-1 1/4"-NPT	310,87
L	160	42	1 1/2" NPT	63	40,0	61	26,0	50	60	LE-L-42-1 1/2"-NPT	319,31

Reihe Series	Druck Pressure PN	Rohr A.D. Tube O.D. D1	Gewinde Thread G	Ca. Maße Approx. Dimensions						Bestellzeichen Order-Code Standard	Brutto-Preis Gross-Price Euro (€)
				L1	L2	L3	i	SW2	SW3		
S	630	6	1/4" NPT	31	16,0	26	15,0	12	17	LE-S-06-1/4"-NPT	32,88
S	630	8	1/4" NPT	32	17,0	27	15,0	14	19	LE-S-08-1/4"-NPT	33,59
S	630	10	1/4" NPT				15,0	17	22	LE-S-10-1/4"-NPT	*
S	630	10	3/8" NPT	34	17,5	28	15,3	17	22	LE-S-10-3/8"-NPT	40,98
S	630	10	1/2" NPT				20,0	17	22	LE-S-10-1/2"-NPT	*
S	630	12	1/4" NPT				15,0	17	24	LE-S-12-1/4"-NPT	*
S	630	12	3/8" NPT	38	21,5	28	15,3	17	24	LE-S-12-3/8"-NPT	47,93
S	630	12	1/2" NPT	38	21,5	33	20,0	19	24	LE-S-12-1/2"-NPT	58,80
S	630	14	1/2" NPT	40	22,0	34	20,0	19	27	LE-S-14-1/2"-NPT	58,80
S	400	16	1/2" NPT	43	24,5	36	20,0	24	30	LE-S-16-1/2"-NPT	92,03
S	400	20	3/4" NPT	48	26,5	42	20,0	27	36	LE-S-20-3/4"-NPT	112,49
S	400	25	1" NPT	54	30,0	48	25,0	36	46	LE-S-25-1"-NPT	175,89
S	400	30	1 1/4" NPT	62	35,5	54	25,5	41	50	LE-S-30-1 1/4"-NPT	233,66
S	315	38	1 1/2" NPT	72	41,0	61	26,0	50	60	LE-S-38-1 1/2"-NPT	432,30

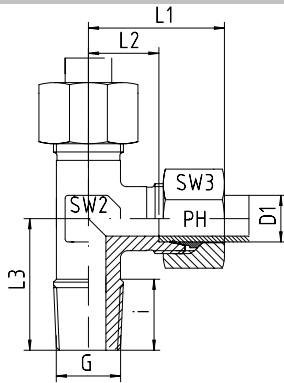

L-Einschraubverschraubungen
L- und S-Reihe
Einschraubgewinde: NPT

Stud Barrel Tees
L- and S-Series
Thread: NPT

Reihe Series	Druck Pressure PN	Rohr A.D. Tube O.D. D1	Gewinde Thread G	Ca. Maße Approx. Dimensions						Bestellzeichen Order-Code SC	Brutto-Preis Gross-Price Euro (€)
				L1	L2	L3	i	SW2	SW3		
L	315	6	1/8" NPT	27	12,0	20	10,0	12	14	LE-L-06-1/8"-NPT-SC	30,81
L	315	6	1/4" NPT	29	14,0	26	15,0	12	14	LE-L-06-1/4"-NPT-SC	31,27
L	315	8	1/4" NPT	29	14,0	26	15,0	12	17	LE-L-08-1/4"-NPT-SC	32,81
L	315	10	1/4" NPT	30	15,0	27	15,0	14	19	LE-L-10-1/4"-NPT-SC	36,16
L	315	10	3/8" NPT				15,3	17	19	LE-L-10-3/8"-NPT-SC	*
L	315	10	1/2" NPT				20,0	17	19	LE-L-10-1/2"-NPT-SC	*
L	315	12	1/4" NPT	32	17,0	28	15,0	17	22	LE-L-12-1/4"-NPT-SC	45,55
L	315	12	3/8" NPT	32	17,0	28	15,3	17	22	LE-L-12-3/8"-NPT-SC	43,69
L	315	12	1/2" NPT				20,0	17	22	LE-L-12-1/2"-NPT-SC	47,09
L	315	15	3/8" NPT				15,3	19	27	LE-L-15-3/8"-NPT-SC	*
L	315	15	1/2" NPT	36	21,0	34	20,0	19	27	LE-L-15-1/2"-NPT-SC	60,70
L	315	18	1/2" NPT	40	23,5	36	20,0	24	32	LE-L-18-1/2"-NPT-SC	97,87
L	160	22	3/4" NPT	44	27,5	42	20,0	27	36	LE-L-22-3/4"-NPT-SC	103,22
L	160	28	1" NPT	47	30,5	48	25,0	36	41	LE-L-28-1"-NPT-SC	167,62
L	160	35	1 1/4" NPT	56	34,5	54	25,5	41	50	LE-L-35-1 1/4"-NPT-SC	318,31
L	160	42	1 1/2" NPT	63	40,0	61	26,0	50	60	LE-L-42-1 1/2"-NPT-SC	327,95

Reihe Series	Druck Pressure PN	Rohr A.D. Tube O.D. D1	Gewinde Thread G	Ca. Maße Approx. Dimensions						Bestellzeichen Order-Code SC	Brutto-Preis Gross-Price Euro (€)
				L1	L2	L3	i	SW2	SW3		
S	630	6	1/4" NPT	31	16,0	26	15,0	12	17	LE-S-06-1/4"-NPT-SC	33,76
S	630	8	1/4" NPT	32	17,0	27	15,0	14	19	LE-S-08-1/4"-NPT-SC	34,47
S	630	10	1/4" NPT				15,0	17	22	LE-S-10-1/4"-NPT-SC	*
S	630	10	3/8" NPT	34	17,5	28	15,3	17	22	LE-S-10-3/8"-NPT-SC	42,10
S	630	10	1/2" NPT				20,0	17	22	LE-S-10-1/2"-NPT-SC	*
S	630	12	1/4" NPT				15,0	17	24	LE-S-12-1/4"-NPT-SC	*
S	630	12	3/8" NPT	38	21,5	28	15,3	17	24	LE-S-12-3/8"-NPT-SC	49,61
S	630	12	1/2" NPT	38	21,5	33	20,0	19	24	LE-S-12-1/2"-NPT-SC	60,48
S	630	14	1/2" NPT	40	22,0	34	20,0	19	27	LE-S-14-1/2"-NPT-SC	61,92
S	400	16	1/2" NPT	43	24,5	36	20,0	24	30	LE-S-16-1/2"-NPT-SC	95,15
S	400	20	3/4" NPT	48	26,5	42	20,0	27	36	LE-S-20-3/4"-NPT-SC	116,25
S	400	25	1" NPT	54	30,0	48	25,0	36	46	LE-S-25-1"-NPT-SC	181,89
S	400	30	1 1/4" NPT	62	35,5	54	25,5	41	50	LE-S-30-1 1/4"-NPT-SC	241,98
S	315	38	1 1/2" NPT	72	41,0	61	26,0	50	60	LE-S-38-1 1/2"-NPT-SC	443,58



L-Einschraubverschraubungsstutzen
LL-, L- und S-Reihe
Einschraubgewinde: NPT

Stud Barrel Tee Bodies
LL-, L- and S-Series
Thread: NPT

Reihe Series	Druck Pressure PN	Rohr A.D. Tube O.D. D1	Gewinde Thread G	Ca. Maße Approx. Dimensions					Bestellzeichen Order-Code OMD	Brutto-Preis Gross-Price Euro (€)
LL	100	4	1/8" NPT						LE-LL-04-1/8"-NPT-OMD	*
LL	100	6	1/8" NPT						LE-LL-06-1/8"-NPT-OMD	*
LL	100	8	1/8" NPT						LE-LL-08-1/8"-NPT-OMD	*

Reihe Series	Druck Pressure PN	Rohr A.D. Tube O.D. D1	Gewinde Thread G	Ca. Maße Approx. Dimensions					Bestellzeichen Order-Code OMD	Brutto-Preis Gross-Price Euro (€)
L	315	6	1/8" NPT						LE-L-06-1/8"-NPT-OMD	25,55
L	315	6	1/4" NPT						LE-L-06-1/4"-NPT-OMD	26,01
L	315	8	1/4" NPT						LE-L-08-1/4"-NPT-OMD	26,33
L	315	10	1/4" NPT						LE-L-10-1/4"-NPT-OMD	28,56
L	315	10	3/8" NPT						LE-L-10-3/8"-NPT-OMD	*
L	315	10	1/2" NPT						LE-L-10-1/2"-NPT-OMD	*
L	315	12	1/4" NPT						LE-L-12-1/4"-NPT-OMD	36,65
L	315	12	3/8" NPT						LE-L-12-3/8"-NPT-OMD	34,79
L	315	12	1/2" NPT						LE-L-12-1/2"-NPT-OMD	38,19
L	315	15	3/8" NPT						LE-L-15-3/8"-NPT-OMD	*
L	315	15	1/2" NPT						LE-L-15-1/2"-NPT-OMD	48,26
L	315	18	1/2" NPT						LE-L-18-1/2"-NPT-OMD	77,35
L	160	22	3/4" NPT						LE-L-22-3/4"-NPT-OMD	79,08
L	160	28	1" NPT						LE-L-28-1"-NPT-OMD	133,92
L	160	35	1 1/4" NPT						LE-L-35-1 1/4"-NPT-OMD	268,65
L	160	42	1 1/2" NPT						LE-L-42-1 1/2"-NPT-OMD	264,45

Reihe Series	Druck Pressure PN	Rohr A.D. Tube O.D. D1	Gewinde Thread G	Ca. Maße Approx. Dimensions					Bestellzeichen Order-Code OMD	Brutto-Preis Gross-Price Euro (€)
S	630	6	1/4" NPT						LE-S-06-1/4"-NPT-OMD	27,30
S	630	8	1/4" NPT						LE-S-08-1/4"-NPT-OMD	27,19
S	630	10	1/4" NPT						LE-S-10-1/4"-NPT-OMD	*
S	630	10	3/8" NPT						LE-S-10-3/8"-NPT-OMD	33,10
S	630	10	1/2" NPT						LE-S-10-1/2"-NPT-OMD	*
S	630	12	1/4" NPT						LE-S-12-1/4"-NPT-OMD	*
S	630	12	3/8" NPT						LE-S-12-3/8"-NPT-OMD	39,03
S	630	12	1/2" NPT						LE-S-12-1/2"-NPT-OMD	49,90
S	630	14	1/2" NPT						LE-S-14-1/2"-NPT-OMD	47,80
S	400	16	1/2" NPT						LE-S-16-1/2"-NPT-OMD	75,61
S	400	20	3/4" NPT						LE-S-20-3/4"-NPT-OMD	91,33
S	400	25	1" NPT						LE-S-25-1"-NPT-OMD	138,65
S	400	30	1 1/4" NPT						LE-S-30-1 1/4"-NPT-OMD	186,78
S	315	38	1 1/2" NPT						LE-S-38-1 1/2"-NPT-OMD	369,02

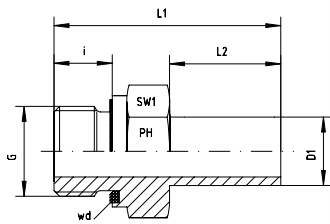

Ohne Vormontage - ov
Einschraubgewinde: Whitworth-Rohrgewinde - Zylindrisch
wd = Abdichtung durch Profildichtung - Viton

Not Pre-Assembled - ov
Thread: BSP - Parallel
wd = Sealing by an Elastomer Profiled Ring - Viton

Reihe Series	Druck Pressure PN	Rohr A.D. Tube O.D. D1	Gewinde Thread G	Ca. Maße Approx. Dimensions				Bestellzeichen Order-Code	Brutto-Preis Gross-Price Euro (€)
				L1	L2	i	SW1		
L	315	6	G 1/8"	32,5	19,0	8	14	EVGE-L-06-G 1/8"-ov-wd	11,39
L	315	6	G 1/4"	39,5	20,5	12	19	EVGE-L-06-G 1/4"-ov-wd	12,54
L	315	8	G 1/4"	41,0	20,5	12	19	EVGE-L-08-G 1/4"-ov-wd	12,05
L	315	8	G 3/8"	42,5	20,5	12	22	EVGE-L-08-G 3/8"-ov-wd	14,54
L	315	10	G 1/4"	39,5	20,5	12	19	EVGE-L-10-G 1/4"-ov-wd	13,31
L	315	10	G 3/8"	44,0	21,0	12	22	EVGE-L-10-G 3/8"-ov-wd	14,54
L	315	10	G 1/2"	47,0	21,0	14	27	EVGE-L-10-G 1/2"-ov-wd	17,94
L	315	12	G 1/4"	42,0	21,5	12	19	EVGE-L-12-G 1/4"-ov-wd	12,78
L	315	12	G 3/8"	45,0	22,0	12	22	EVGE-L-12-G 3/8"-ov-wd	14,03
L	315	12	G 1/2"	48,5	22,5	14	27	EVGE-L-12-G 1/2"-ov-wd	17,94
L	315	15	G 3/8"	45,5	22,5	12	22	EVGE-L-15-G 3/8"-ov-wd	17,02
L	315	15	G 1/2"	46,0	23,0	14	27	EVGE-L-15-G 1/2"-ov-wd	17,02
L	315	18	G 3/8"	44,0	23,5	12	22	EVGE-L-18-G 3/8"-ov-wd	26,66
L	315	18	G 1/2"	47,0	24,0	14	27	EVGE-L-18-G 1/2"-ov-wd	23,59
L	160	18	G 3/4"	52,0	24,0	16	32	EVGE-L-18-G 3/4"-ov-wd	31,26
L	160	22	G 3/8"	46,0	24,5	12	24	EVGE-L-22-G 3/8"-ov-wd	28,29
L	160	22	G 1/2"	50,5	24,5	14	27	EVGE-L-22-G 1/2"-ov-wd	28,29
L	160	22	G 3/4"	50,5	24,5	16	32	EVGE-L-22-G 3/4"-ov-wd	29,90
L	160	22	G 1"	52,5	25,5	18	41	EVGE-L-22-G 1"-ov-wd	*
L	160	28	G 3/4"	52,5	25,5	16	32	EVGE-L-28-G 3/4"-ov-wd	69,07
L	160	28	G 1"	54,0	25,5	18	41	EVGE-L-28-G 1"-ov-wd	46,51
L	160	35	G 1 1/4"	63,5	32,0	20	50	EVGE-L-35-G 1 1/4"-ov-wd	76,04
L	160	42	G 1 1/2"	70,0	32,0	22	55	EVGE-L-42-G 1 1/2"-ov-wd	82,50

Reihe Series	Druck Pressure PN	Rohr A.D. Tube O.D. D1	Gewinde Thread G	Ca. Maße Approx. Dimensions				Bestellzeichen Order-Code	Brutto-Preis Gross-Price Euro (€)
				L1	L2	i	SW1		
S	630	6	G 1/8"	32,5	19,0	8	14	EVGE-S-06-G 1/8"-ov-wd	11,88
S	630	6	G 1/4"	39,5	20,5	12	19	EVGE-S-06-G 1/4"-ov-wd	11,88
S	630	8	G 1/4"	41,0	20,5	12	19	EVGE-S-08-G 1/4"-ov-wd	11,99
S	630	8	G 3/8"	42,5	20,5	12	22	EVGE-S-08-G 3/8"-ov-wd	14,54
S	630	10	G 1/4"	39,5	20,5	12	19	EVGE-S-10-G 1/4"-ov-wd	12,98
S	630	10	G 3/8"	44,0	21,0	12	22	EVGE-S-10-G 3/8"-ov-wd	14,21
S	630	10	G 1/2"	46,5	20,5	14	27	EVGE-S-10-G 1/2"-ov-wd	17,94
S	630	12	G 1/4"	42,0	21,5	12	19	EVGE-S-12-G 1/4"-ov-wd	13,19
S	630	12	G 3/8"	45,0	22,0	12	22	EVGE-S-12-G 3/8"-ov-wd	14,52
S	630	12	G 1/2"	48,5	22,5	14	27	EVGE-S-12-G 1/2"-ov-wd	18,94
S	630	14	G 1/2"	51,0	24,5	14	27	EVGE-S-14-G 1/2"-ov-wd	19,78
S	400	16	G 3/8"	48,5	26,0	12	22	EVGE-S-16-G 3/8"-ov-wd	27,53
S	400	16	G 1/2"	51,0	26,0	14	27	EVGE-S-16-G 1/2"-ov-wd	26,25
S	400	16	G 3/4"	54,5	26,0	16	32	EVGE-S-16-G 3/4"-ov-wd	30,52
S	400	20	G 1/2"	56,5	29,5	14	27	EVGE-S-20-G 1/2"-ov-wd	27,16
S	400	20	G 3/4"	59,0	29,0	16	32	EVGE-S-20-G 3/4"-ov-wd	34,08
S	400	25	G 3/4"	63,0	33,0	16	32	EVGE-S-25-G 3/4"-ov-wd	50,41
S	400	25	G 1"	66,0	33,0	18	41	EVGE-S-25-G 1"-ov-wd	50,41
S	400	30	G 1 1/4"	71,0	34,0	20	50	EVGE-S-30-G 1 1/4"-ov-wd	60,75
S	315	38	G 1 1/2"	83,5	40,0	22	55	EVGE-S-38-G 1 1/2"-ov-wd	85,28

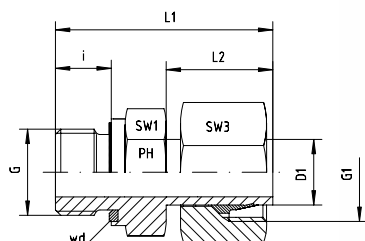

Vormontiert

Einschraubgewinde: Whitworth-Rohrgewinde - Zylindrisch
wd = Abdichtung durch Profildichtung - Viton
Anschluss D1 ist vormontiert. Die Fertigmontage erfolgt im
Stutzen mit ca. 1/2 Umdrehung der Überwurfmutter über
den Punkt des deutlich fühlbaren Kraftanstieges.

Pre-Assembled

Thread: BSP - Parallel
wd = Sealing by an Elastomer Profiled Ring - Viton
Port D1 is pre-assembled. Final assembly in appropriate
body with approx. 1/2 turn beyond the point of clearly
perceptible resistance.

Reihe Series	Druck Pressure PN	Rohr A.D. Tube O.D. D1	Gewinde Thread G	Ca. Maße Approx. Dimensions					Bestellzeichen Order-Code Standard	Brutto-Preis Gross-Price Euro (€)
				L1	L2	i	SW1	SW3		
L	315	6	G 1/8"	32,5	19,0	8	14	14	EVGE-L-06-G 1/8"-wd	13,70
L	315	6	G 1/4"	39,5	20,5	12	19	14	EVGE-L-06-G 1/4"-wd	14,85
L	315	8	G 1/4"	41,0	20,5	12	19	17	EVGE-L-08-G 1/4"-wd	14,85
L	315	8	G 3/8"	42,5	20,5	12	22	17	EVGE-L-08-G 3/8"-wd	17,90
L	315	10	G 1/4"	39,5	20,5	12	19	19	EVGE-L-10-G 1/4"-wd	16,67
L	315	10	G 3/8"	44,0	21,0	12	22	19	EVGE-L-10-G 3/8"-wd	17,90
L	315	10	G 1/2"	47,0	21,0	14	27	19	EVGE-L-10-G 1/2"-wd	21,30
L	315	12	G 1/4"	42,0	21,5	12	19	22	EVGE-L-12-G 1/4"-wd	16,67
L	315	12	G 3/8"	45,0	22,0	12	22	22	EVGE-L-12-G 3/8"-wd	17,92
L	315	12	G 1/2"	48,5	22,5	14	27	22	EVGE-L-12-G 1/2"-wd	21,83
L	315	15	G 3/8"	45,5	22,5	12	22	27	EVGE-L-15-G 3/8"-wd	22,16
L	315	15	G 1/2"	46,0	23,0	14	27	27	EVGE-L-15-G 1/2"-wd	22,16
L	315	18	G 3/8"	44,0	23,5	12	22	32	EVGE-L-18-G 3/8"-wd	35,28
L	315	18	G 1/2"	47,0	24,0	14	27	32	EVGE-L-18-G 1/2"-wd	32,21
L	160	18	G 3/4"	52,0	24,0	16	32	32	EVGE-L-18-G 3/4"-wd	39,88
L	160	22	G 3/8"	46,0	24,5	12	24	36	EVGE-L-22-G 3/8"-wd	38,60
L	160	22	G 1/2"	50,5	24,5	14	27	36	EVGE-L-22-G 1/2"-wd	38,60
L	160	22	G 3/4"	50,5	24,5	16	32	36	EVGE-L-22-G 3/4"-wd	40,21
L	160	22	G 1"	52,5	25,5	18	41	36	EVGE-L-22-G 1"-wd	*
L	160	28	G 3/4"	52,5	25,5	16	32	41	EVGE-L-28-G 3/4"-wd	83,92
L	160	28	G 1"	54,0	25,5	18	41	41	EVGE-L-28-G 1"-wd	61,36
L	160	35	G 1 1/4"	63,5	32,0	20	50	50	EVGE-L-35-G 1 1/4"-wd	97,15
L	160	42	G 1 1/2"	70,0	32,0	22	55	60	EVGE-L-42-G 1 1/2"-wd	109,93

Reihe Series	Druck Pressure PN	Rohr A.D. Tube O.D. D1	Gewinde Thread G	Ca. Maße Approx. Dimensions					Bestellzeichen Order-Code Standard	Brutto-Preis Gross-Price Euro (€)
				L1	L2	i	SW1	SW3		
S	630	6	G 1/8"	32,5	19,0	8	14	17	EVGE-S-06-G 1/8"-wd	14,67
S	630	6	G 1/4"	39,5	20,5	12	19	17	EVGE-S-06-G 1/4"-wd	14,67
S	630	8	G 1/4"	41,0	20,5	12	19	19	EVGE-S-08-G 1/4"-wd	15,19
S	630	8	G 3/8"	42,5	20,5	12	22	19	EVGE-S-08-G 3/8"-wd	17,90
S	630	10	G 1/4"	39,5	20,5	12	19	22	EVGE-S-10-G 1/4"-wd	16,92
S	630	10	G 3/8"	44,0	21,0	12	22	22	EVGE-S-10-G 3/8"-wd	18,15
S	630	10	G 1/2"	47,0	21,0	14	27	22	EVGE-S-10-G 1/2"-wd	21,88
S	630	12	G 1/4"	42,0	21,5	12	19	24	EVGE-S-12-G 1/4"-wd	17,64
S	630	12	G 3/8"	45,0	22,0	12	22	24	EVGE-S-12-G 3/8"-wd	18,97
S	630	12	G 1/2"	48,5	22,5	14	27	24	EVGE-S-12-G 1/2"-wd	23,39
S	630	14	G 1/2"	51,0	24,5	14	27	27	EVGE-S-14-G 1/2"-wd	25,28
S	400	16	G 3/8"	48,5	26,0	12	22	30	EVGE-S-16-G 3/8"-wd	35,74
S	400	16	G 1/2"	51,0	26,0	14	27	30	EVGE-S-16-G 1/2"-wd	34,46
S	400	16	G 3/4"	54,5	26,0	16	32	30	EVGE-S-16-G 3/4"-wd	38,73
S	400	20	G 1/2"	56,5	29,5	14	27	36	EVGE-S-20-G 1/2"-wd	37,74
S	400	20	G 3/4"	59,0	29,0	16	32	36	EVGE-S-20-G 3/4"-wd	44,66
S	400	25	G 3/4"	63,0	33,0	16	32	46	EVGE-S-25-G 3/4"-wd	69,03
S	400	25	G 1"	66,0	33,0	18	41	46	EVGE-S-25-G 1"-wd	69,03
S	400	30	G 1 1/4"	71,0	34,0	20	50	50	EVGE-S-30-G 1 1/4"-wd	84,19
S	315	38	G 1 1/2"	83,5	40,0	22	55	60	EVGE-S-38-G 1 1/2"-wd	117,09

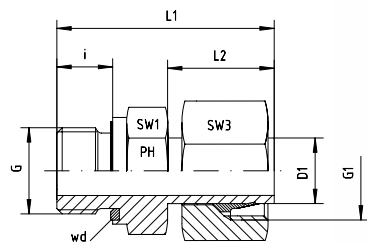

Vormontiert

Einschraubgewinde: Whitworth-Rohrgewinde - Zylindrisch
wd = Abdichtung durch Profildichtung - Viton
Anschluss D1 ist vormontiert. Die Fertigmontage erfolgt im
Stutzen mit ca. 1/2 Umdrehung der Überwurfmutter über
den Punkt des deutlich fühlbaren Kraftanstieges.

Pre-Assembled

Thread: BSP - Parallel
wd = Sealing by an Elastomer Profiled Ring - Viton
Port D1 is pre-assembled. Final assembly in appropriate
body with approx. 1/2 turn beyond the point of clearly
perceptible resistance.

Reihe Series	Druck Pressure PN	Rohr A.D. Tube O.D. D1	Gewinde Thread G	Ca. Maße Approx. Dimensions					Bestellzeichen Order-Code SC	Brutto-Preis Gross-Price Euro (€)
				L1	L2	i	SW1	SW3		
L	315	6	G 1/8"	32,5	19,0	8	14	14	EVGE-L-06-G 1/8"-wd-SC	14,02
L	315	6	G 1/4"	39,5	20,5	12	19	14	EVGE-L-06-G 1/4"-wd-SC	15,17
L	315	8	G 1/4"	41,0	20,5	12	19	17	EVGE-L-08-G 1/4"-wd-SC	15,29
L	315	8	G 3/8"	42,5	20,5	12	22	17	EVGE-L-08-G 3/8"-wd-SC	18,34
L	315	10	G 1/4"	39,5	20,5	12	19	19	EVGE-L-10-G 1/4"-wd-SC	17,11
L	315	10	G 3/8"	44,0	21,0	12	22	19	EVGE-L-10-G 3/8"-wd-SC	18,34
L	315	10	G 1/2"	47,0	21,0	14	27	19	EVGE-L-10-G 1/2"-wd-SC	21,74
L	315	12	G 1/4"	42,0	21,5	12	19	22	EVGE-L-12-G 1/4"-wd-SC	17,23
L	315	12	G 3/8"	45,0	22,0	12	22	22	EVGE-L-12-G 3/8"-wd-SC	18,48
L	315	12	G 1/2"	48,5	22,5	14	27	22	EVGE-L-12-G 1/2"-wd-SC	22,39
L	315	15	G 3/8"	45,5	22,5	12	22	27	EVGE-L-15-G 3/8"-wd-SC	23,24
L	315	15	G 1/2"	46,0	23,0	14	27	27	EVGE-L-15-G 1/2"-wd-SC	23,24
L	315	18	G 3/8"	44,0	23,5	12	22	32	EVGE-L-18-G 3/8"-wd-SC	36,92
L	315	18	G 1/2"	47,0	24,0	14	27	32	EVGE-L-18-G 1/2"-wd-SC	33,85
L	160	18	G 3/4"	52,0	24,0	16	32	32	EVGE-L-18-G 3/4"-wd-SC	41,52
L	160	22	G 3/8"	46,0	24,5	12	24	36	EVGE-L-22-G 3/8"-wd-SC	40,36
L	160	22	G 1/2"	50,5	24,5	14	27	36	EVGE-L-22-G 1/2"-wd-SC	40,36
L	160	22	G 3/4"	50,5	24,5	16	32	36	EVGE-L-22-G 3/4"-wd-SC	41,97
L	160	22	G 1"	52,5	25,5	18	41	36	EVGE-L-22-G 1"-wd-SC	*
L	160	28	G 3/4"	52,5	25,5	16	32	41	EVGE-L-28-G 3/4"-wd-SC	86,60
L	160	28	G 1"	54,0	25,5	18	41	41	EVGE-L-28-G 1"-wd-SC	63,36
L	160	35	G 1 1/4"	63,5	32,0	20	50	50	EVGE-L-35-G 1 1/4"-wd-SC	100,87
L	160	42	G 1 1/2"	70,0	32,0	22	55	60	EVGE-L-42-G 1 1/2"-wd-SC	114,25

Reihe Series	Druck Pressure PN	Rohr A.D. Tube O.D. D1	Gewinde Thread G	Ca. Maße Approx. Dimensions					Bestellzeichen Order-Code SC	Brutto-Preis Gross-Price Euro (€)
				L1	L2	i	SW1	SW3		
S	630	6	G 1/8"	32,5	19,0	8	14	17	EVGE-S-06-G 1/8"-wd-SC	15,11
S	630	6	G 1/4"	39,5	20,5	12	19	17	EVGE-S-06-G 1/4"-wd-SC	15,11
S	630	8	G 1/4"	41,0	20,5	12	19	19	EVGE-S-08-G 1/4"-wd-SC	15,63
S	630	8	G 3/8"	42,5	20,5	12	22	19	EVGE-S-08-G 3/8"-wd-SC	18,34
S	630	10	G 1/4"	39,5	20,5	12	19	22	EVGE-S-10-G 1/4"-wd-SC	17,48
S	630	10	G 3/8"	44,0	21,0	12	22	22	EVGE-S-10-G 3/8"-wd-SC	18,71
S	630	10	G 1/2"	47,0	21,0	14	27	22	EVGE-S-10-G 1/2"-wd-SC	22,44
S	630	12	G 1/4"	42,0	21,5	12	19	24	EVGE-S-12-G 1/4"-wd-SC	18,48
S	630	12	G 3/8"	45,0	22,0	12	22	24	EVGE-S-12-G 3/8"-wd-SC	19,81
S	630	12	G 1/2"	48,5	22,5	14	27	24	EVGE-S-12-G 1/2"-wd-SC	24,23
S	630	14	G 1/2"	51,0	24,5	14	27	27	EVGE-S-14-G 1/2"-wd-SC	26,84
S	400	16	G 3/8"	48,5	26,0	12	22	30	EVGE-S-16-G 3/8"-wd-SC	37,30
S	400	16	G 1/2"	51,0	26,0	14	27	30	EVGE-S-16-G 1/2"-wd-SC	36,02
S	400	16	G 3/4"	54,5	26,0	16	32	30	EVGE-S-16-G 3/4"-wd-SC	40,29
S	400	20	G 1/2"	56,5	29,5	14	27	36	EVGE-S-20-G 1/2"-wd-SC	39,62
S	400	20	G 3/4"	59,0	29,0	16	32	36	EVGE-S-20-G 3/4"-wd-SC	46,54
S	400	25	G 3/4"	63,0	33,0	16	32	46	EVGE-S-25-G 3/4"-wd-SC	72,03
S	400	25	G 1"	66,0	33,0	18	41	46	EVGE-S-25-G 1"-wd-SC	72,03
S	400	30	G 1 1/4"	71,0	34,0	20	50	50	EVGE-S-30-G 1 1/4"-wd-SC	88,35
S	315	38	G 1 1/2"	83,5	40,0	22	55	60	EVGE-S-38-G 1 1/2"-wd-SC	122,73

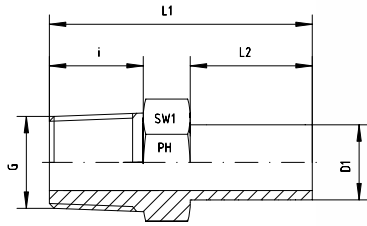

Ohne Vormontage - ov
Einschraubgewinde: NPT

Not Pre-Assembled - ov
Thread: NPT

Reihe Series	Druck Pressure PN	Rohr A.D. Tube O.D. D1	Gewinde Thread G	Ca. Maße Approx. Dimensions				Bestellzeichen Order-Code	Brutto-Preis Gross-Price Euro (€)
				L1	L2	i	SW1		
L	315	6	1/8" NPT	32,0	19,0	10,0	12	EVGE-L-06-1/8"-ov-NPT	8,81
L	315	6	1/4" NPT	40,0	19,0	15,0	14	EVGE-L-06-1/4"-ov-NPT	10,17
L	315	8	1/4" NPT	40,5	20,0	15,0	14	EVGE-L-08-1/4"-ov-NPT	9,68
L	315	10	1/4" NPT	39,5	19,0	15,0	14	EVGE-L-10-1/4"-ov-NPT	10,32
L	315	12	1/4" NPT	42,0	22,0	15,0	14	EVGE-L-12-1/4"-ov-NPT	11,42
L	315	12	3/8" NPT	43,0	22,0	15,3	19	EVGE-L-12-3/8"-ov-NPT	12,88
L	315	12	1/2" NPT	50,0	22,0	20,0	22	EVGE-L-12-1/2"-ov-NPT	13,11
L	315	15	3/8" NPT			15,3	19	EVGE-L-15-3/8"-ov-NPT	13,22
L	315	15	1/2" NPT	48,0	22,0	20,0	22	EVGE-L-15-1/2"-ov-NPT	17,54
L	315	18	1/2" NPT	50,0	24,0	20,0	22	EVGE-L-18-1/2"-ov-NPT	27,07
L	160	22	3/4" NPT	52,0	24,5	20,0	27	EVGE-L-22-3/4"-ov-NPT	33,51
L	160	28	1" NPT	59,0	25,5	25,0	36	EVGE-L-28-1"-ov-NPT	54,18
L	160	35	1 1/4" NPT	66,0	32,0	25,5	46	EVGE-L-35-1 1/4"-ov-NPT	93,93
L	160	42	1 1/2" NPT	68,0	32,0	26,0	50	EVGE-L-42-1 1/2"-ov-NPT	97,84

Reihe Series	Druck Pressure PN	Rohr A.D. Tube O.D. D1	Gewinde Thread G	Ca. Maße Approx. Dimensions				Bestellzeichen Order-Code	Brutto-Preis Gross-Price Euro (€)
				L1	L2	i	SW1		
S	630	6	1/4" NPT	40,0	19,0	15,0	14	EVGE-S-06-1/4"-ov-NPT	10,86
S	630	8	1/4" NPT	40,5	20,0	15,0	14	EVGE-S-08-1/4"-ov-NPT	11,12
S	630	10	1/4" NPT	39,5	19,0	15,0	14	EVGE-S-10-1/4"-ov-NPT	11,32
S	630	10	3/8" NPT	44,0	21,0	15,3	19	EVGE-S-10-3/8"-ov-NPT	13,19
S	630	12	1/4" NPT	42,0	22,0	15,0	14	EVGE-S-12-1/4"-ov-NPT	15,85
S	630	12	3/8" NPT	43,0	22,0	15,3	19	EVGE-S-12-3/8"-ov-NPT	16,87
S	630	12	1/2" NPT	50,0	22,0	20,0	22	EVGE-S-12-1/2"-ov-NPT	18,66
S	630	14	1/2" NPT	48,0	23,5	20,0	22	EVGE-S-14-1/2"-ov-NPT	20,17
S	400	16	1/2" NPT	54,0	24,0	20,0	22	EVGE-S-16-1/2"-ov-NPT	28,71
S	400	20	3/4" NPT	58,0	28,0	20,0	27	EVGE-S-20-3/4"-ov-NPT	36,64
S	400	25	1" NPT	68,0	33,0	25,0	36	EVGE-S-25-1"-ov-NPT	57,56
S	400	30	1 1/4" NPT	73,0	33,0	25,5	46	EVGE-S-30-1 1/4"-ov-NPT	101,83
S	315	38	1 1/2" NPT	81,0	38,0	26,0	50	EVGE-S-38-1 1/2"-ov-NPT	104,71

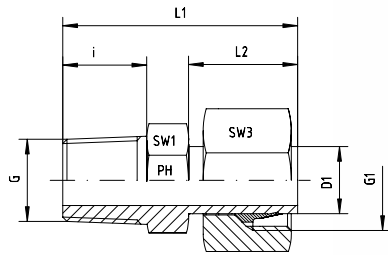

Vormontiert

Einschraubgewinde: NPT

Anschluss D1 ist vormontiert. Die Fertigmontage erfolgt im Studen mit ca. 1/2 Umdrehung der Überwurfmutter über den Punkt des deutlich fühlbaren Kraftanstieges.

Pre-Assembled

Thread: NPT

Port D1 is pre-assembled. Final assembly in appropriate body with approx. 1/2 turn beyond the point of clearly perceptible resistance.

Reihe Series	Druck Pressure PN	Rohr A.D. Tube O.D. D1	Gewinde Thread		Ca. Maße Approx. Dimensions					Bestellzeichen Order-Code Standard	Brutto-Preis Gross-Price Euro (€)
			G	G1	L1	L2	i	SW1	SW3		
L	315	6	1/8" NPT	M 12 x 1,5	32,0	19,0	10,0	12	14	EVGE-L-06-1/8"-NPT	11,12
L	315	6	1/4" NPT	M 12 x 1,5	40,0	19,0	15,0	14	14	EVGE-L-06-1/4"-NPT	12,48
L	315	8	1/4" NPT	M 14 x 1,5	40,5	20,0	15,0	14	17	EVGE-L-08-1/4"-NPT	12,48
L	315	10	1/4" NPT	M 16 x 1,5	39,5	19,0	15,0	14	19	EVGE-L-10-1/4"-NPT	13,68
L	315	12	1/4" NPT	M 18 x 1,5	42,0	22,0	15,0	14	22	EVGE-L-12-1/4"-NPT	15,31
L	315	12	3/8" NPT	M 18 x 1,5	43,0	22,0	15,3	19	22	EVGE-L-12-3/8"-NPT	16,77
L	315	12	1/2" NPT	M 18 x 1,5	50,0	22,0	20,0	22	22	EVGE-L-12-1/2"-NPT	17,00
L	315	15	3/8" NPT	M 22 x 1,5			15,3	19	27	EVGE-L-15-3/8"-NPT	18,36
L	315	15	1/2" NPT	M 22 x 1,5	48,0	22,0	20,0	22	27	EVGE-L-15-1/2"-NPT	22,68
L	315	18	1/2" NPT	M 26 x 1,5	50,0	24,0	20,0	22	32	EVGE-L-18-1/2"-NPT	35,69
L	160	22	3/4" NPT	M 30 x 2	52,0	24,5	20,0	27	36	EVGE-L-22-3/4"-NPT	43,82
L	160	28	1" NPT	M 36 x 2	59,0	25,5	25,0	36	41	EVGE-L-28-1"-NPT	69,03
L	160	35	1 1/4" NPT	M 45 x 2	66,0	32,0	25,5	46	50	EVGE-L-35-1 1/4"-NPT	115,04
L	160	42	1 1/2" NPT	M 52 x 2	68,0	32,0	26,0	50	60	EVGE-L-42-1 1/2"-NPT	125,27

Reihe Series	Druck Pressure PN	Rohr A.D. Tube O.D. D1	Gewinde Thread		Ca. Maße Approx. Dimensions					Bestellzeichen Order-Code Standard	Brutto-Preis Gross-Price Euro (€)
			G	G1	L1	L2	i	SW1	SW3		
S	630	6	1/4" NPT	M 14 x 1,5	40,0	19,0	15,0	14	17	EVGE-S-06-1/4"-NPT	13,65
S	630	8	1/4" NPT	M 16 x 1,5	40,5	20,0	15,0	14	19	EVGE-S-08-1/4"-NPT	14,32
S	630	10	1/4" NPT	M 18 x 1,5	39,5	19,0	15,0	14	22	EVGE-S-10-1/4"-NPT	15,26
S	630	10	3/8" NPT	M 18 x 1,5	44,0	21,0	15,3	19	22	EVGE-S-10-3/8"-NPT	17,13
S	630	12	1/4" NPT	M 20 x 1,5	42,0	22,0	15,0	14	24	EVGE-S-12-1/4"-NPT	20,30
S	630	12	3/8" NPT	M 20 x 1,5	43,0	22,0	15,3	19	24	EVGE-S-12-3/8"-NPT	21,32
S	630	12	1/2" NPT	M 20 x 1,5	50,0	22,0	20,0	22	24	EVGE-S-12-1/2"-NPT	23,11
S	630	14	1/2" NPT	M 22 x 1,5	48,0	23,5	20,0	22	27	EVGE-S-14-1/2"-NPT	25,67
S	400	16	1/2" NPT	M 24 x 1,5	54,0	24,0	20,0	22	30	EVGE-S-16-1/2"-NPT	36,92
S	400	20	3/4" NPT	M 30 x 2	58,0	28,0	20,0	27	36	EVGE-S-20-3/4"-NPT	47,22
S	400	25	1" NPT	M 36 x 2	68,0	33,0	25,0	36	46	EVGE-S-25-1"-NPT	76,18
S	400	30	1 1/4" NPT	M 42 x 2	73,0	33,0	25,5	46	50	EVGE-S-30-1 1/4"-NPT	125,27
S	315	38	1 1/2" NPT	M 52 x 2	81,0	38,0	26,0	50	60	EVGE-S-38-1 1/2"-NPT	136,52

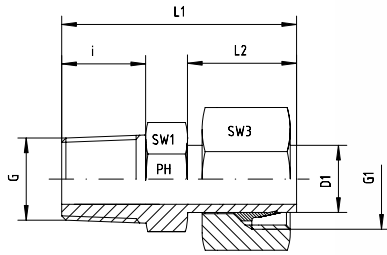

Vormontiert

Einschraubgewinde: NPT

Anschluss D1 ist vormontiert. Die Fertigmontage erfolgt im Stutzen mit ca. 1/2 Umdrehung der Überwurfmutter über den Punkt des deutlich fühlbaren Kraftanstieges.

Pre-Assembled

Thread: NPT

Port D1 is pre-assembled. Final assembly in appropriate body with approx. 1/2 turn beyond the point of clearly perceptible resistance.

Reihe Series	Druck Pressure PN	Rohr A.D. Tube O.D. D1	Gewinde Thread		Ca. Maße Approx. Dimensions					Bestellzeichen Order-Code SC	Brutto-Preis Gross-Price Euro (€)
			G	G1	L1	L2	i	SW1	SW3		
L	315	6	1/8" NPT	M 12 x 1,5	32,0	19,0	10,0	12	14	EVGE-L-06-1/8"-NPT-SC	11,44
L	315	6	1/4" NPT	M 12 x 1,5	40,0	19,0	15,0	14	14	EVGE-L-06-1/4"-NPT-SC	12,80
L	315	8	1/4" NPT	M 14 x 1,5	40,5	20,0	15,0	14	17	EVGE-L-08-1/4"-NPT-SC	12,92
L	315	10	1/4" NPT	M 16 x 1,5	39,5	19,0	15,0	14	19	EVGE-L-10-1/4"-NPT-SC	14,12
L	315	12	1/4" NPT	M 18 x 1,5	42,0	22,0	15,0	14	22	EVGE-L-12-1/4"-NPT-SC	15,87
L	315	12	3/8" NPT	M 18 x 1,5	43,0	22,0	15,3	19	22	EVGE-L-12-3/8"-NPT-SC	17,33
L	315	12	1/2" NPT	M 18 x 1,5	50,0	22,0	20,0	22	22	EVGE-L-12-1/2"-NPT-SC	17,56
L	315	15	3/8" NPT	M 22 x 1,5			15,3	19	27	EVGE-L-15-3/8"-NPT-SC	19,44
L	315	15	1/2" NPT	M 22 x 1,5	48,0	22,0	20,0	22	27	EVGE-L-15-1/2"-NPT-SC	23,76
L	315	18	1/2" NPT	M 26 x 1,5	50,0	24,0	20,0	22	32	EVGE-L-18-1/2"-NPT-SC	37,33
L	160	22	3/4" NPT	M 30 x 2	52,0	24,5	20,0	27	36	EVGE-L-22-3/4"-NPT-SC	45,58
L	160	28	1" NPT	M 36 x 2	59,0	25,5	25,0	36	41	EVGE-L-28-1"-NPT-SC	71,03
L	160	35	1 1/4" NPT	M 45 x 2	66,0	32,0	25,5	46	50	EVGE-L-35-1 1/4"-NPT-SC	118,76
L	160	42	1 1/2" NPT	M 52 x 2	68,0	32,0	26,0	50	60	EVGE-L-42-1 1/2"-NPT-SC	129,59

Reihe Series	Druck Pressure PN	Rohr A.D. Tube O.D. D1	Gewinde Thread		Ca. Maße Approx. Dimensions					Bestellzeichen Order-Code SC	Brutto-Preis Gross-Price Euro (€)
			G	G1	L1	L2	i	SW1	SW3		
S	630	6	1/4" NPT	M 14 x 1,5	40,0	19,0	15,0	14	17	EVGE-S-06-1/4"-NPT-SC	14,09
S	630	8	1/4" NPT	M 16 x 1,5	40,5	20,0	15,0	14	19	EVGE-S-08-1/4"-NPT-SC	14,76
S	630	10	1/4" NPT	M 18 x 1,5	39,5	19,0	15,0	14	22	EVGE-S-10-1/4"-NPT-SC	15,82
S	630	10	3/8" NPT	M 18 x 1,5	44,0	21,0	15,3	19	22	EVGE-S-10-3/8"-NPT-SC	17,69
S	630	12	1/4" NPT	M 20 x 1,5	42,0	22,0	15,0	14	24	EVGE-S-12-1/4"-NPT-SC	21,14
S	630	12	3/8" NPT	M 20 x 1,5	43,0	22,0	15,3	19	24	EVGE-S-12-3/8"-NPT-SC	22,16
S	630	12	1/2" NPT	M 20 x 1,5	50,0	22,0	20,0	22	24	EVGE-S-12-1/2"-NPT-SC	23,95
S	630	14	1/2" NPT	M 22 x 1,5	48,0	23,5	20,0	22	27	EVGE-S-14-1/2"-NPT-SC	27,23
S	400	16	1/2" NPT	M 24 x 1,5	54,0	24,0	20,0	22	30	EVGE-S-16-1/2"-NPT-SC	38,48
S	400	20	3/4" NPT	M 30 x 2	58,0	28,0	20,0	27	36	EVGE-S-20-3/4"-NPT-SC	49,10
S	400	25	1" NPT	M 36 x 2	68,0	33,0	25,0	36	46	EVGE-S-25-1"-NPT-SC	79,18
S	400	30	1 1/4" NPT	M 42 x 2	73,0	33,0	25,5	46	50	EVGE-S-30-1 1/4"-NPT-SC	129,43
S	315	38	1 1/2" NPT	M 52 x 2	81,0	38,0	26,0	50	60	EVGE-S-38-1 1/2"-NPT-SC	142,16

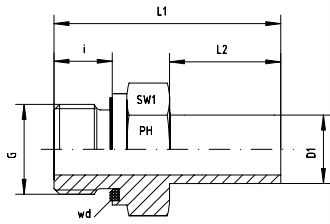

Ohne Vormontage

Einschraubgewinde: Metrisches Feingewinde - Zylindrisch
wd = Abdichtung durch Profildichtung - Viton

Not Pre-Assembled

Thread: Metric - Parallel

wd = Sealing by an Elastomer Profiled Ring - Viton

Reihe Series	Druck Pressure PN	Rohr A.D. Tube O.D. D1	Gewinde Thread G	Ca. Maße Approx. Dimensions				Bestellzeichen Order-Code	Brutto-Preis Gross-Price Euro (€)
				L1	L2	i	SW1		
L	315	6	M 10 x 1	32,5	19,0	8	14	EVGE-L-06-M 10x1-ov-wd	11,42
L	315	8	M 12 x 1,5	38,5	19,5	12	17	EVGE-L-08-M 12x1,5-ov-wd	12,16
L	315	10	M 14 x 1,5	39,5	20,5	12	19	EVGE-L-10-M 14x1,5-ov-wd	13,10
L	315	12	M 16 x 1,5	42,0	22,0	12	22	EVGE-L-12-M 16x1,5-ov-wd	14,87
L	315	15	M 18 x 1,5	43,5	23,0	12	24	EVGE-L-15-M 18x1,5-ov-wd	18,25
L	315	18	M 22 x 1,5	47,0	24,0	14	27	EVGE-L-18-M 22x1,5-ov-wd	24,61
L	160	22	M 26 x 1,5	50,5	24,5	16	32	EVGE-L-22-M 26x1,5-ov-wd	30,42
L	160	28	M 33 x 2	54,0	25,5	18	41	EVGE-L-28-M 33x2-ov-wd	46,51
L	160	35	M 42 x 2	62,5	30,5	20	50	EVGE-L-35-M 42x2-ov-wd	78,59
L	160	42	M 48 x 2	68,5	32,5	22	55	EVGE-L-42-M 48x2-ov-wd	82,50

Reihe Series	Druck Pressure PN	Rohr A.D. Tube O.D. D1	Gewinde Thread G	Ca. Maße Approx. Dimensions				Bestellzeichen Order-Code	Brutto-Preis Gross-Price Euro (€)
				L1	L2	i	SW1		
S	630	6	M 12 x 1,5	39,5	19,0	12	17	EVGE-S-06-M 12x1,5-ov-wd	11,63
S	630	8	M 14 x 1,5	40,5	19,5	12	19	EVGE-S-08-M 14x1,5-ov-wd	12,60
S	630	10	M 16 x 1,5	44,0	21,5	12	22	EVGE-S-10-M 16x1,5-ov-wd	14,29
S	630	12	M 18 x 1,5	46,0	22,5	12	24	EVGE-S-12-M 18x1,5-ov-wd	15,72
S	630	14	M 20 x 1,5	50,0	23,5	14	27	EVGE-S-14-M 20x1,5-ov-wd	18,86
S	400	16	M 22 x 1,5	51,0	24,0	14	27	EVGE-S-16-M 22x1,5-ov-wd	25,25
S	400	20	M 27 x 2	59,0	28,0	16	32	EVGE-S-20-M 27x2-ov-wd	35,74
S	400	25	M 33 x 2	65,5	31,0	18	41	EVGE-S-25-M 33x2-ov-wd	50,41
S	400	30	M 42 x 2	71,0	34,0	20	50	EVGE-S-30-M 42x2-ov-wd	58,37
S	315	38	M 48 x 2	83,5	40,0	22	55	EVGE-S-38-M 48x2-ov-wd	93,46

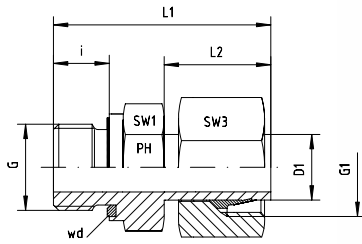

Vormontiert

Einschraubgewinde: Metrisches Feingewinde - Zylindrisch
wd = Abdichtung durch Profildichtung - Viton

Pre-Assembled

Thread: Metric - Parallel

wd = Sealing by an Elastomer Profiled Ring - Viton

Reihe Series	Druck Pressure PN	Rohr A.D. Tube O.D. D1	Gewinde Thread		Ca. Maße Approx. Dimensions					Bestellzeichen Order-Code Standard	Brutto-Preis Gross-Price Euro (€)
			G	G1	L1	L2	i	SW1	SW3		
L	315	6	M 10 x 1	M 12 x 1,5	32,5	19,0	8	14	14	EVGE-L-06-M 10x1-wd	13,73
L	315	8	M 12 x 1,5	M 14 x 1,5	38,5	19,5	12	17	17	EVGE-L-08-M 12x1,5-wd	14,96
L	315	10	M 14 x 1,5	M 16 x 1,5	39,5	20,5	12	19	19	EVGE-L-10-M 14x1,5-wd	16,46
L	315	12	M 16 x 1,5	M 18 x 1,5	42,0	22,0	12	22	22	EVGE-L-12-M 16x1,5-wd	18,76
L	315	15	M 18 x 1,5	M 22 x 1,5	43,5	23,0	12	24	27	EVGE-L-15-M 18x1,5-wd	23,39
L	315	18	M 22 x 1,5	M 26 x 1,5	47,0	24,0	14	27	32	EVGE-L-18-M 22x1,5-wd	33,23
L	160	22	M 26 x 1,5	M 30 x 2	50,5	24,5	16	32	36	EVGE-L-22-M 26x1,5-wd	40,73
L	160	28	M 33 x 2	M 36 x 2	54,0	25,5	18	41	41	EVGE-L-28-M 33x2-wd	61,36
L	160	35	M 42 x 2	M 45 x 2	62,5	30,5	20	50	50	EVGE-L-35-M 42x2-wd	99,70
L	160	42	M 48 x 2	M 52 x 2	68,5	32,5	22	55	60	EVGE-L-42-M 48x2-wd	109,93

Reihe Series	Druck Pressure PN	Rohr A.D. Tube O.D. D1	Gewinde Thread		Ca. Maße Approx. Dimensions					Bestellzeichen Order-Code Standard	Brutto-Preis Gross-Price Euro (€)
			G	G1	L1	L2	i	SW1	SW3		
S	630	6	M 12 x 1,5	M 14 x 1,5	39,5	19,0	12	17	17	EVGE-S-06-M 12x1,5-wd	14,42
S	630	8	M 14 x 1,5	M 16 x 1,5	40,5	19,5	12	19	19	EVGE-S-08-M 14x1,5-wd	15,80
S	630	10	M 16 x 1,5	M 18 x 1,5	44,0	21,5	12	22	22	EVGE-S-10-M 16x1,5-wd	18,23
S	630	12	M 18 x 1,5	M 20 x 1,5	46,0	22,5	12	24	24	EVGE-S-12-M 18x1,5-wd	20,17
S	630	14	M 20 x 1,5	M 22 x 1,5	50,0	23,5	14	27	27	EVGE-S-14-M 20x1,5-wd	24,36
S	400	16	M 22 x 1,5	M 24 x 1,5	51,0	24,0	14	27	30	EVGE-S-16-M 22x1,5-wd	33,46
S	400	20	M 27 x 2	M 30 x 2	59,0	28,0	16	32	36	EVGE-S-20-M 27x2-wd	46,32
S	400	25	M 33 x 2	M 36 x 2	65,5	31,0	18	41	46	EVGE-S-25-M 33x2-wd	69,03
S	400	30	M 42 x 2	M 42 x 2	71,0	34,0	20	50	50	EVGE-S-30-M 42x2-wd	81,81
S	315	38	M 48 x 2	M 52 x 2	83,5	40,0	22	55	60	EVGE-S-38-M 48x2-wd	125,27

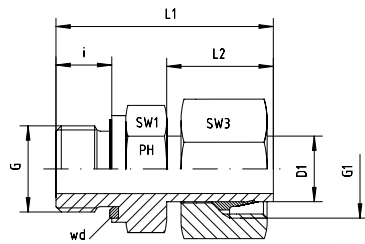

Vormontiert

Einschraubgewinde: Metrisches Feingewinde - Zylindrisch
wd = Abdichtung durch Profildichtung - Viton

Pre-Assembled

Thread: Metric - Parallel

wd = Sealing by an Elastomer Profiled Ring - Viton

Reihe Series	Druck Pressure PN	Rohr A.D. Tube O.D. D1	Gewinde Thread		Ca. Maße Approx. Dimensions					Bestellzeichen Order-Code SC	Brutto-Preis Gross-Price Euro (€)
			G	G1	L1	L2	i	SW1	SW3		
L	315	6	M 10 x 1	M 12 x 1,5	32,5	19,0	8	14	14	EVGE-L-06-M 10x1-wd-SC	14,05
L	315	8	M 12 x 1,5	M 14 x 1,5	38,5	19,5	12	17	17	EVGE-L-08-M 12x1,5-wd-SC	15,40
L	315	10	M 14 x 1,5	M 16 x 1,5	39,5	20,5	12	19	19	EVGE-L-10-M 14x1,5-wd-SC	16,90
L	315	12	M 16 x 1,5	M 18 x 1,5	42,0	22,0	12	22	22	EVGE-L-12-M 16x1,5-wd-SC	19,32
L	315	15	M 18 x 1,5	M 22 x 1,5	43,5	23,0	12	24	27	EVGE-L-15-M 18x1,5-wd-SC	24,47
L	315	18	M 22 x 1,5	M 26 x 1,5	47,0	24,0	14	27	32	EVGE-L-18-M 22x1,5-wd-SC	34,87
L	160	22	M 26 x 1,5	M 30 x 2	50,5	24,5	16	32	36	EVGE-L-22-M 26x1,5-wd-SC	42,49
L	160	28	M 33 x 2	M 36 x 2	54,0	25,5	18	41	41	EVGE-L-28-M 33x2-wd-SC	63,36
L	160	35	M 42 x 2	M 45 x 2	62,5	30,5	20	50	50	EVGE-L-35-M 42x2-wd-SC	103,42
L	160	42	M 48 x 2	M 52 x 2	68,5	32,5	22	55	60	EVGE-L-42-M 48x2-wd-SC	114,25

Reihe Series	Druck Pressure PN	Rohr A.D. Tube O.D. D1	Gewinde Thread		Ca. Maße Approx. Dimensions					Bestellzeichen Order-Code SC	Brutto-Preis Gross-Price Euro (€)
			G	G1	L1	L2	i	SW1	SW3		
S	630	6	M 12 x 1,5	M 14 x 1,5	39,5	19,0	12	17	17	EVGE-S-06-M 12x1,5-wd-SC	14,86
S	630	8	M 14 x 1,5	M 16 x 1,5	40,5	19,5	12	19	19	EVGE-S-08-M 14x1,5-wd-SC	16,24
S	630	10	M 16 x 1,5	M 18 x 1,5	44,0	21,5	12	22	22	EVGE-S-10-M 16x1,5-wd-SC	18,79
S	630	12	M 18 x 1,5	M 20 x 1,5	46,0	22,5	12	24	24	EVGE-S-12-M 18x1,5-wd-SC	21,01
S	630	14	M 20 x 1,5	M 22 x 1,5	50,0	23,5	14	27	27	EVGE-S-14-M 20x1,5-wd-SC	25,92
S	400	16	M 22 x 1,5	M 24 x 1,5	51,0	24,0	14	27	30	EVGE-S-16-M 22x1,5-wd-SC	35,02
S	400	20	M 27 x 2	M 30 x 2	59,0	28,0	16	32	36	EVGE-S-20-M 27x2-wd-SC	48,20
S	400	25	M 33 x 2	M 36 x 2	65,5	31,0	18	41	46	EVGE-S-25-M 33x2-wd-SC	72,03
S	400	30	M 42 x 2	M 42 x 2	71,0	34,0	20	50	50	EVGE-S-30-M 42x2-wd-SC	85,97
S	315	38	M 48 x 2	M 52 x 2	83,5	40,0	22	55	60	EVGE-S-38-M 48x2-wd-SC	130,91

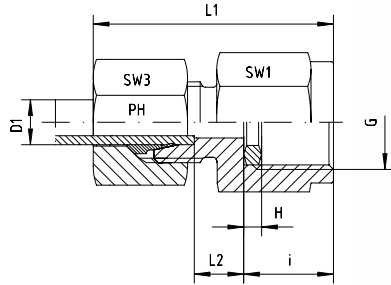

Manometer-Verschraubungen
Mit Dichtkantenring - DKRi
Innengewinde: Whitworth-Rohrgewinde - Zylindrisch

Gauge Couplings
With Metal Sealing Ring - DKRi
Internal Thread: BSP - Female - Parallel

Reihe Series	Druck Pressure PN	Rohr A.D. Tube O.D. D1	Gewinde Thread G	Ca. Maße Approx. Dimensions						Bestellzeichen Order-Code Standard	Brutto-Preis Gross-Price Euro (€)
				L1	L2	i	H	SW1	SW3		
L	315	6	G 1/4"	37,0	7,5	14,5	4,5	19	14	MV-L-06-G 1/4"	12,45
L	315	6	G 1/2"	46,0	9,0	20,0	5,0	27	14	MV-L-06-G 1/2"	19,58
L	315	8	G 1/4"	37,0	7,5	14,5	4,5	19	17	MV-L-08-G 1/4"	12,96
L	315	8	G 1/2"	46,0	9,0	20,0	5,0	27	17	MV-L-08-G 1/2"	19,58
L	315	10	G 1/4"	38,0	8,5	14,5	4,5	19	19	MV-L-10-G 1/4"	13,63
L	315	10	G 1/2"	47,0	9,5	20,0	5,0	27	19	MV-L-10-G 1/2"	19,69
L	315	12	G 1/4"	38,0	8,5	14,5	4,5	19	22	MV-L-12-G 1/4"	13,81
L	315	12	G 1/2"	48,0	10,0	20,0	5,0	27	22	MV-L-12-G 1/2"	19,84

Reihe Series	Druck Pressure PN	Rohr A.D. Tube O.D. D1	Gewinde Thread G	Ca. Maße Approx. Dimensions						Bestellzeichen Order-Code Standard	Brutto-Preis Gross-Price Euro (€)
				L1	L2	i	H	SW1	SW3		
S	630	6	G 1/2"	46,0	11,0	20,0	5,0	27	17	MV-S-06-G 1/2"	17,90
S	630	8	G 1/4"	40,0	9,5	14,5	4,5	19	19	MV-S-08-G 1/4"	21,00
S	630	8	G 1/2"	46,0	11,0	20,0	5,0	27	19	MV-S-08-G 1/2"	18,28
S	630	10	G 1/4"	40,5	9,0	14,5	4,5	19	22	MV-S-10-G 1/4"	19,10
S	630	10	G 1/2"	47,0	10,5	20,0	5,0	27	22	MV-S-10-G 1/2"	19,10
S	630	12	G 1/4"	41,0	8,0	14,5	4,5	22	24	MV-S-12-G 1/4"	19,66
S	630	12	G 1/2"	47,0	10,5	20,0	5,0	27	24	MV-S-12-G 1/2"	19,66

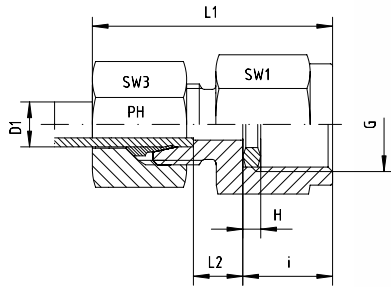

Manometer-Verschraubungen
Mit Dichtkantenring - DKRi
Innengewinde: Whitworth-Rohrgewinde - Zylindrisch

Gauge Couplings
With Metal Sealing Ring - DKRi
Internal Thread: BSP - Female - Parallel

Reihe Series	Druck Pressure PN	Rohr A.D. Tube O.D. D1	Gewinde Thread G	Ca. Maße Approx. Dimensions						Bestellzeichen Order-Code SC	Brutto-Preis Gross-Price Euro (€)
				L1	L2	i	H	SW1	SW3		
L	315	6	G 1/4"	37,0	7,5	14,5	4,5	19	14	MV-L-06-G 1/4"-SC	12,77
L	315	6	G 1/2"	46,0	9,0	20,0	5,0	27	14	MV-L-06-G 1/2"-SC	19,90
L	315	8	G 1/4"	37,0	7,5	14,5	4,5	19	17	MV-L-08-G 1/4"-SC	13,40
L	315	8	G 1/2"	46,0	9,0	20,0	5,0	27	17	MV-L-08-G 1/2"-SC	20,02
L	315	10	G 1/4"	38,0	8,5	14,5	4,5	19	19	MV-L-10-G 1/4"-SC	14,07
L	315	10	G 1/2"	47,0	9,5	20,0	5,0	27	19	MV-L-10-G 1/2"-SC	20,13
L	315	12	G 1/4"	38,0	8,5	14,5	4,5	19	22	MV-L-12-G 1/4"-SC	14,37
L	315	12	G 1/2"	48,0	10,0	20,0	5,0	27	22	MV-L-12-G 1/2"-SC	20,40

Reihe Series	Druck Pressure PN	Rohr A.D. Tube O.D. D1	Gewinde Thread G	Ca. Maße Approx. Dimensions						Bestellzeichen Order-Code SC	Brutto-Preis Gross-Price Euro (€)
				L1	L2	i	H	SW1	SW3		
S	630	6	G 1/2"	46,0	11,0	20,0	5,0	27	17	MV-S-06-G 1/2"-SC	18,34
S	630	8	G 1/4"	40,0	9,5	14,5	4,5	19	19	MV-S-08-G 1/4"-SC	21,44
S	630	8	G 1/2"	46,0	11,0	20,0	5,0	27	19	MV-S-08-G 1/2"-SC	18,72
S	630	10	G 1/4"	40,5	9,0	14,5	4,5	19	22	MV-S-10-G 1/4"-SC	19,66
S	630	10	G 1/2"	47,0	10,5	20,0	5,0	27	22	MV-S-10-G 1/2"-SC	19,66
S	630	12	G 1/4"	41,0	8,0	14,5	4,5	22	24	MV-S-12-G 1/4"-SC	20,50
S	630	12	G 1/2"	47,0	10,5	20,0	5,0	27	24	MV-S-12-G 1/2"-SC	20,50



Manometer-Verschraubungsstutzen
Mit Dichtkantenring - DKRi
Innengewinde: Whitworth-Rohrgewinde - Zylindrisch

Gauge Coupling Bodies
With Metal Sealing Ring - DKRi
Internal Thread: BSP - Female - Parallel

Reihe Series	Druck Pressure PN	Rohr A.D. Tube O.D. D1	Gewinde Thread G	Ca. Maße Approx. Dimensions						Bestellzeichen Order-Code OMD	Brutto-Preis Gross-Price Euro (€)
L	315	6	G 1/4"							MV-L-06-G 1/4"-OMD	10,14
L	315	6	G 1/2"							MV-L-06-G 1/2"-OMD	17,27
L	315	8	G 1/4"							MV-L-08-G 1/4"-OMD	10,16
L	315	8	G 1/2"							MV-L-08-G 1/2"-OMD	16,78
L	315	10	G 1/4"							MV-L-10-G 1/4"-OMD	10,27
L	315	10	G 1/2"							MV-L-10-G 1/2"-OMD	16,33
L	315	12	G 1/4"							MV-L-12-G 1/4"-OMD	9,92
L	315	12	G 1/2"							MV-L-12-G 1/2"-OMD	15,95

Reihe Series	Druck Pressure PN	Rohr A.D. Tube O.D. D1	Gewinde Thread G	Ca. Maße Approx. Dimensions						Bestellzeichen Order-Code OMD	Brutto-Preis Gross-Price Euro (€)
S	630	6	G 1/2"							MV-S-06-G 1/2"-OMD	15,11
S	630	8	G 1/4"							MV-S-08-G 1/4"-OMD	17,80
S	630	8	G 1/2"							MV-S-08-G 1/2"-OMD	15,08
S	630	10	G 1/4"							MV-S-10-G 1/4"-OMD	15,16
S	630	10	G 1/2"							MV-S-10-G 1/2"-OMD	15,16
S	630	12	G 1/4"							MV-S-12-G 1/4"-OMD	15,21
S	630	12	G 1/2"							MV-S-12-G 1/2"-OMD	15,21

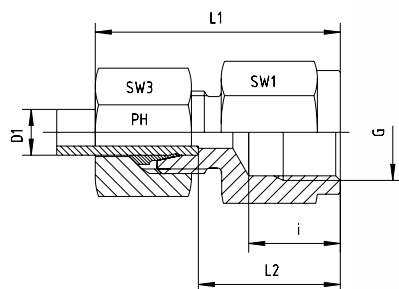

Manometer-Verschraubungen
Innengewinde: NPT

Gauge Couplings
Internal Thread: NPT

Reihe Series	Druck Pressure PN	Rohr A.D. Tube O.D. D1	Gewinde Thread G	Ca. Maße Approx. Dimensions					Bestellzeichen Order-Code Standard	Brutto-Preis Gross-Price Euro (€)
				L1	L2	i	SW1	SW3		
L	315	6	1/4" NPT	38	23,5	16,4	19	14	MV-L-06-NPT-1/4"	14,39
L	315	6	1/2" NPT	46	31,0	22,6	27	14	MV-L-06-NPT-1/2"	20,45
L	315	8	1/4" NPT	38	23,5	16,4	19	17	MV-L-08-NPT-1/4"	14,90
L	315	8	1/2" NPT	46	31,0	22,6	27	17	MV-L-08-NPT-1/2"	21,55
L	315	10	1/4" NPT	39	24,0	16,4	19	19	MV-L-10-NPT-1/4"	15,93
L	315	10	1/2" NPT	47	32,0	22,6	27	19	MV-L-10-NPT-1/2"	22,11
L	315	12	1/4" NPT			16,4	19	22	MV-L-12-NPT-1/4"	16,82
L	315	12	1/2" NPT	47	32,0	22,6	27	22	MV-L-12-NPT-1/2"	23,01

Reihe Series	Druck Pressure PN	Rohr A.D. Tube O.D. D1	Gewinde Thread G	Ca. Maße Approx. Dimensions					Bestellzeichen Order-Code Standard	Brutto-Preis Gross-Price Euro (€)
				L1	L2	i	SW1	SW3		
S	630	6	1/2" NPT	48	33,0	22,6	27	17	MV-S-06-NPT-1/2"	20,45
S	630	8	1/2" NPT	48	33,0	22,6	27	19	MV-S-08-NPT-1/2"	21,55
S	630	10	1/2" NPT	49	32,5	22,6	27	22	MV-S-10-NPT-1/2"	22,11
S	630	12	1/2" NPT	49	32,5	22,6	27	24	MV-S-12-NPT-1/2"	23,01

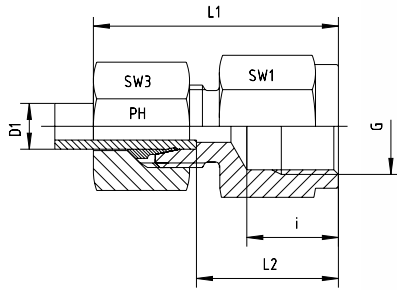

Manometer-Verschraubungen
Innengewinde: NPT

Gauge Couplings
Internal Thread: NPT

Reihe Series	Druck Pressure PN	Rohr A.D. Tube O.D. D1	Gewinde Thread G	Ca. Maße Approx. Dimensions					Bestellzeichen Order-Code SC	Brutto-Preis Gross-Price Euro (€)
				L1	L2	i	SW1	SW3		
L	315	6	1/4" NPT	38	23,5	16,4	19	14	MV-L-06-NPT-1/4"-SC	14,71
L	315	6	1/2" NPT	46	31,0	22,6	27	14	MV-L-06-NPT-1/2"-SC	20,77
L	315	8	1/4" NPT	38	23,5	16,4	19	17	MV-L-08-NPT-1/4"-SC	15,34
L	315	8	1/2" NPT	46	31,0	22,6	27	17	MV-L-08-NPT-1/2"-SC	21,99
L	315	10	1/4" NPT	39	24,0	16,4	19	19	MV-L-10-NPT-1/4"-SC	16,37
L	315	10	1/2" NPT	47	32,0	22,6	27	19	MV-L-10-NPT-1/2"-SC	22,55
L	315	12	1/4" NPT			16,4	19	22	MV-L-12-NPT-1/4"-SC	17,38
L	315	12	1/2" NPT	47	32,0	22,6	27	22	MV-L-12-NPT-1/2"-SC	23,57

Reihe Series	Druck Pressure PN	Rohr A.D. Tube O.D. D1	Gewinde Thread G	Ca. Maße Approx. Dimensions					Bestellzeichen Order-Code SC	Brutto-Preis Gross-Price Euro (€)
				L1	L2	i	SW1	SW3		
S	630	6	1/2" NPT	48	33,0	22,6	27	17	MV-S-06-NPT-1/2"-SC	20,89
S	630	8	1/2" NPT	48	33,0	22,6	27	19	MV-S-08-NPT-1/2"-SC	21,99
S	630	10	1/2" NPT	49	32,5	22,6	27	22	MV-S-10-NPT-1/2"-SC	22,67
S	630	12	1/2" NPT	49	32,5	22,6	27	24	MV-S-12-NPT-1/2"-SC	23,85



Manometer-Verschraubungsstutzen
Innengewinde: NPT

Gauge Coupling Bodies
Internal Thread: NPT

Reihe Series	Druck Pressure PN	Rohr A.D. Tube O.D. D1	Gewinde Thread G	Ca. Maße Approx. Dimensions					Bestellzeichen Order-Code OMD	Brutto-Preis Gross-Price Euro (€)
L	315	6	1/4" NPT						MV-L-06-NPT-1/4"-OMD	12,08
L	315	6	1/2" NPT						MV-L-06-NPT-1/2"-OMD	18,14
L	315	8	1/4" NPT						MV-L-08-NPT-1/4"-OMD	12,10
L	315	8	1/2" NPT						MV-L-08-NPT-1/2"-OMD	18,75
L	315	10	1/4" NPT						MV-L-10-NPT-1/4"-OMD	12,57
L	315	10	1/2" NPT						MV-L-10-NPT-1/2"-OMD	18,75
L	315	12	1/4" NPT						MV-L-12-NPT-1/4"-OMD	12,93
L	315	12	1/2" NPT						MV-L-12-NPT-1/2"-OMD	19,12

Reihe Series	Druck Pressure PN	Rohr A.D. Tube O.D. D1	Gewinde Thread G	Ca. Maße Approx. Dimensions					Bestellzeichen Order-Code OMD	Brutto-Preis Gross-Price Euro (€)
S	630	6	1/2" NPT						MV-S-06-NPT-1/2"-OMD	17,66
S	630	8	1/2" NPT						MV-S-08-NPT-1/2"-OMD	18,35
S	630	10	1/2" NPT						MV-S-10-NPT-1/2"-OMD	18,17
S	630	12	1/2" NPT						MV-S-12-NPT-1/2"-OMD	18,56

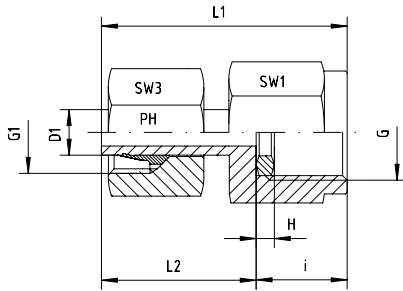

Einstellbare Manometer-Verschraubungen

Mit Dichtkantenring - DKRi

Innengewinde: Whitworth-Rohrgewinde - Zylindrisch

Anschluss D1 ist vormontiert. Die Fertigmontage erfolgt im Stutzen mit ca. 1/2 Umdrehung der Überwurfmutter über den Punkt des deutlich fühlbaren Kraftanstieges.

Gauge Swivel Couplings

With Metal Sealing Ring - DKRi

Thread: BSP - Female - Parallel

Port D1 is pre-assembled. Final assembly in appropriate body with approx. 1/2 turn beyond the point of clearly perceptible resistance.

Reihe Series	Druck Pressure PN	Rohr A.D. Tube O.D. D1	Gewinde Thread		Ca. Maße Approx. Dimensions						Bestellzeichen Order-Code Standard	Brutto-Preis Gross-Price Euro (€)
			G	G1	L1	L2	i	H	SW1	SW3		
L	315	6	G 1/4"	M 12 x 1,5	38,0		14,5	4,5	19	14	MV-ev-L-06-G 1/4"	17,38
L	315	6	G 1/2"	M 12 x 1,5	45,0		20,0	5,0	27	14	MV-ev-L-06-G 1/2"	26,20
L	315	8	G 1/4"	M 14 x 1,5	38,0		14,5	4,5	19	17	MV-ev-L-08-G 1/4"	18,07
L	315	8	G 1/2"	M 14 x 1,5	47,6		20,0	5,0	27	17	MV-ev-L-08-G 1/2"	27,12
L	315	10	G 1/4"	M 16 x 1,5	39,5		14,5	4,5	19	19	MV-ev-L-10-G 1/4"	18,87
L	315	10	G 1/2"	M 16 x 1,5	47,0		20,0	5,0	27	19	MV-ev-L-10-G 1/2"	28,45
L	315	12	G 1/4"	M 18 x 1,5	40,5		14,5	4,5	19	22	MV-ev-L-12-G 1/4"	19,61
L	315	12	G 1/2"	M 18 x 1,5	47,5		20,0	5,0	27	22	MV-ev-L-12-G 1/2"	29,53

Reihe Series	Druck Pressure PN	Rohr A.D. Tube O.D. D1	Gewinde Thread		Ca. Maße Approx. Dimensions						Bestellzeichen Order-Code Standard	Brutto-Preis Gross-Price Euro (€)
			G	G1	L1	L2	i	H	SW1	SW3		
S	630	6	G 1/4"	M 14 x 1,5	38,0		14,5	4,5	19	17	MV-ev-S-06-G 1/4"	17,38
S	630	6	G 1/2"	M 14 x 1,5	45,0		20,0	5,0	27	17	MV-ev-S-06-G 1/2"	26,20
S	630	8	G 1/4"	M 16 x 1,5	38,0		14,5	4,5	19	19	MV-ev-S-08-G 1/4"	18,07
S	630	8	G 1/2"	M 16 x 1,5	47,6		20,0	5,0	27	19	MV-ev-S-08-G 1/2"	27,12
S	630	10	G 1/4"	M 18 x 1,5	39,5		14,5	4,5	19	22	MV-ev-S-10-G 1/4"	18,87
S	630	10	G 1/2"	M 18 x 1,5	47,0		20,0	5,0	27	22	MV-ev-S-10-G 1/2"	28,45
S	630	12	G 1/4"	M 20 x 1,5	40,5		14,5	4,5	19	24	MV-ev-S-12-G 1/4"	19,61
S	630	12	G 1/2"	M 20 x 1,5	47,5		20,0	5,0	27	24	MV-ev-S-12-G 1/2"	29,53

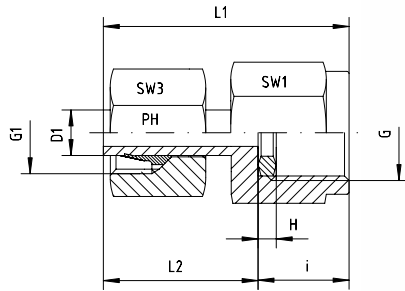

Einstellbare Manometer-Verschraubungen

Mit Dichtkantenring - DKRi

Innengewinde: Whitworth-Rohrgewinde - Zylindrisch

Anschluss D1 ist vormontiert. Die Fertigmontage erfolgt im Stutzen mit ca. 1/2 Umdrehung der Überwurfmutter über den Punkt des deutlich fühlbaren Kraftanstieges.

Gauge Swivel Couplings

With Metal Sealing Ring - DKRi

Thread: BSP - Female - Parallel

Port D1 is pre-assembled. Final assembly in appropriate body with approx. 1/2 turn beyond the point of clearly perceptible resistance.

Reihe Series	Druck Pressure PN	Rohr A.D. Tube O.D. D1	Gewinde Thread		Ca. Maße Approx. Dimensions						Bestellzeichen Order-Code SC	Brutto-Preis Gross-Price Euro (€)
			G	G1	L1	L2	i	H	SW1	SW3		
L	315	6	G 1/4"	M 12 x 1,5	38,0		14,5	4,5	19	14	MV-ev-L-06-G 1/4"-SC	17,70
L	315	6	G 1/2"	M 12 x 1,5	45,0		20,0	5,0	27	14	MV-ev-L-06-G 1/2"-SC	26,52
L	315	8	G 1/4"	M 14 x 1,5	38,0		14,5	4,5	19	17	MV-ev-L-08-G 1/4"-SC	18,51
L	315	8	G 1/2"	M 14 x 1,5	47,6		20,0	5,0	27	17	MV-ev-L-08-G 1/2"-SC	27,56
L	315	10	G 1/4"	M 16 x 1,5	39,5		14,5	4,5	19	19	MV-ev-L-10-G 1/4"-SC	19,31
L	315	10	G 1/2"	M 16 x 1,5	47,0		20,0	5,0	27	19	MV-ev-L-10-G 1/2"-SC	28,89
L	315	12	G 1/4"	M 18 x 1,5	40,5		14,5	4,5	19	22	MV-ev-L-12-G 1/4"-SC	20,17
L	315	12	G 1/2"	M 18 x 1,5	47,5		20,0	5,0	27	22	MV-ev-L-12-G 1/2"-SC	30,09

Reihe Series	Druck Pressure PN	Rohr A.D. Tube O.D. D1	Gewinde Thread		Ca. Maße Approx. Dimensions						Bestellzeichen Order-Code SC	Brutto-Preis Gross-Price Euro (€)
			G	G1	L1	L2	i	H	SW1	SW3		
S	630	6	G 1/4"	M 14 x 1,5	38,0		14,5	4,5	19	17	MV-ev-S-06-G 1/4"-SC	17,82
S	630	6	G 1/2"	M 14 x 1,5	45,0		20,0	5,0	27	17	MV-ev-S-06-G 1/2"-SC	26,64
S	630	8	G 1/4"	M 16 x 1,5	38,0		14,5	4,5	19	19	MV-ev-S-08-G 1/4"-SC	18,51
S	630	8	G 1/2"	M 16 x 1,5	47,6		20,0	5,0	27	19	MV-ev-S-08-G 1/2"-SC	27,56
S	630	10	G 1/4"	M 18 x 1,5	39,5		14,5	4,5	19	22	MV-ev-S-10-G 1/4"-SC	19,43
S	630	10	G 1/2"	M 18 x 1,5	47,0		20,0	5,0	27	22	MV-ev-S-10-G 1/2"-SC	29,01
S	630	12	G 1/4"	M 20 x 1,5	40,5		14,5	4,5	19	24	MV-ev-S-12-G 1/4"-SC	20,45
S	630	12	G 1/2"	M 20 x 1,5	47,5		20,0	5,0	27	24	MV-ev-S-12-G 1/2"-SC	30,37



Einstellbare Manometer-Verschraubungsstutzen
Mit Dichtkantenring - DKRi
Innengewinde: Whitworth-Rohrgewinde - Zylindrisch

Gauge Swivel Coupling Bodies
With Metal Sealing Ring - DKRi
Thread: BSP - Female - Parallel

Reihe Series	Druck Pressure PN	Rohr A.D. Tube O.D. D1	Gewinde Thread		Ca. Maße Approx. Dimensions					Bestellzeichen Order-Code OMD	Brutto-Preis Gross-Price Euro (€)	
			G									
L	315	6	G 1/4"								MV-ev-L-06-G 1/4"-OMD	15,07
L	315	6	G 1/2"								MV-ev-L-06-G 1/2"-OMD	23,89
L	315	8	G 1/4"								MV-ev-L-08-G 1/4"-OMD	15,27
L	315	8	G 1/2"								MV-ev-L-08-G 1/2"-OMD	24,32
L	315	10	G 1/4"								MV-ev-L-10-G 1/4"-OMD	15,51
L	315	10	G 1/2"								MV-ev-L-10-G 1/2"-OMD	25,09
L	315	12	G 1/4"								MV-ev-L-12-G 1/4"-OMD	15,72
L	315	12	G 1/2"								MV-ev-L-12-G 1/2"-OMD	25,64

Reihe Series	Druck Pressure PN	Rohr A.D. Tube O.D. D1	Gewinde Thread		Ca. Maße Approx. Dimensions					Bestellzeichen Order-Code OMD	Brutto-Preis Gross-Price Euro (€)	
			G									
S	630	6	G 1/4"								MV-ev-S-06-G 1/4"-OMD	14,59
S	630	6	G 1/2"								MV-ev-S-06-G 1/2"-OMD	23,41
S	630	8	G 1/4"								MV-ev-S-08-G 1/4"-OMD	14,87
S	630	8	G 1/2"								MV-ev-S-08-G 1/2"-OMD	23,92
S	630	10	G 1/4"								MV-ev-S-10-G 1/4"-OMD	14,93
S	630	10	G 1/2"								MV-ev-S-10-G 1/2"-OMD	24,51
S	630	12	G 1/4"								MV-ev-S-12-G 1/4"-OMD	15,16
S	630	12	G 1/2"								MV-ev-S-12-G 1/2"-OMD	25,08

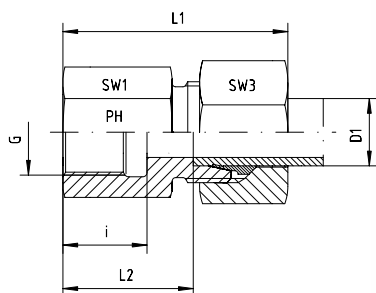

Gerade Aufschraub-Verschraubungen
Innengewinde: Whitworth-Rohrgewinde - Zylindrisch

Female Stud Couplings
Female Thread: BSP - Parallel

Reihe Series	Druck Pressure PN	Rohr A.D. Tube O.D. D1	Gewinde Thread G	Ca. Maße Approx. Dimensions					Bestellzeichen Order-Code Standard	Brutto-Preis Gross-Price Euro (€)
				L1	L2	i	SW1	SW3		
L	315	6	G 1/8"	36,0	19,0	12,0	14	14	GAI-L-06-G 1/8"	12,02
L	315	6	G 1/4"	41,0	24,0	17,0	19	14	GAI-L-06-G 1/4"	14,06
L	315	6	G 3/8"	42,0	24,0	17,0	24	14	GAI-L-06-G 3/8"	18,12
L	315	6	G 1/2"	46,0	31,0	20,0	27	14	GAI-L-06-G 1/2"	22,70
L	315	8	G 1/8"	36,0	19,0	12,0	14	17	GAI-L-08-G 1/8"	16,20
L	315	8	G 1/4"	41,0	24,0	17,0	19	17	GAI-L-08-G 1/4"	15,85
L	315	8	G 3/8"	42,0	25,0	17,0	24	17	GAI-L-08-G 3/8"	18,12
L	315	8	G 1/2"	46,0	32,0	20,0	27	17	GAI-L-08-G 1/2"	23,19
L	315	10	G 1/8"	36,0	19,0	12,0	17	19	GAI-L-10-G 1/8"	16,25
L	315	10	G 1/4"	42,0	25,0	17,0	19	19	GAI-L-10-G 1/4"	15,80
L	315	10	G 3/8"	43,0	26,0	17,0	24	19	GAI-L-10-G 3/8"	19,17
L	315	10	G 1/2"	47,0	30,0	20,0	27	19	GAI-L-10-G 1/2"	23,75
L	315	12	G 1/4"	42,0	25,0	17,0	19	22	GAI-L-12-G 1/4"	18,66
L	315	12	G 3/8"	43,0	26,0	17,0	24	22	GAI-L-12-G 3/8"	18,66
L	315	12	G 1/2"	48,0	30,0	20,0	27	22	GAI-L-12-G 1/2"	21,70
L	315	15	G 3/8"	46,0	27,0	17,5	24	27	GAI-L-15-G 3/8"	21,99
L	315	15	G 1/2"	49,0	31,0	20,0	27	27	GAI-L-15-G 1/2"	24,90
L	160	15	G 3/4"	53,0	34,0	22,0	32	27	GAI-L-15-G 3/4"	43,13
L	315	18	G 3/8"	47,0	26,5	17,5	27	32	GAI-L-18-G 3/8"	29,83
L	315	18	G 1/2"	50,5	30,5	20,0	27	32	GAI-L-18-G 1/2"	29,83
L	160	18	G 3/4"	53,5	33,5	22,0	36	32	GAI-L-18-G 3/4"	43,13
L	160	22	G 1/2"	55,0	33,5	20,0	32	36	GAI-L-22-G 1/2"	40,21
L	160	22	G 3/4"	56,0	35,5	22,0	36	36	GAI-L-22-G 3/4"	38,40
L	160	28	G 3/4"	57,5	35,0	22,0	41	41	GAI-L-28-G 3/4"	69,20
L	160	28	G 1"	60,5	38,0	24,5	41	41	GAI-L-28-G 1"	54,15
L	160	35	G 1 1/4"	68,5	41,0	26,5	55	50	GAI-L-35-G 1 1/4"	89,48
L	160	42	G 1 1/2"	69,5	42,5	28,5	60	60	GAI-L-42-G 1 1/2"	112,49

Reihe Series	Druck Pressure PN	Rohr A.D. Tube O.D. D1	Gewinde Thread G	Ca. Maße Approx. Dimensions					Bestellzeichen Order-Code Standard	Brutto-Preis Gross-Price Euro (€)
				L1	L2	i	SW1	SW3		
S	630	6	G 1/4"	42,0	26,0	17,0	19	17	GAI-S-06-G 1/4"	15,93
S	630	6	G 3/8"			17,0	24	17	GAI-S-06-G 3/8"	*
S	630	6	G 1/2"	48,0	31,0	20,0	27	17	GAI-S-06-G 1/2"	*
S	630	8	G 1/4"	43,0	26,0	17,0	19	19	GAI-S-08-G 1/4"	16,31
S	630	8	G 3/8"	44,0	27,0	17,0	24	19	GAI-S-08-G 3/8"	21,80
S	630	8	G 1/2"	48,0	31,0	20,0	27	19	GAI-S-08-G 1/2"	23,70
S	630	10	G 3/8"	45,0	26,5	17,0	24	22	GAI-S-10-G 3/8"	21,47
S	630	10	G 1/2"	49,5	30,5	20,0	27	22	GAI-S-10-G 1/2"	23,52
S	630	12	G 1/4"	46,0	27,5	17,0	22	24	GAI-S-12-G 1/4"	23,01
S	630	12	G 3/8"	45,0	26,5	17,0	24	24	GAI-S-12-G 3/8"	22,37
S	630	12	G 1/2"	50,0	30,5	20,0	27	24	GAI-S-12-G 1/2"	23,52
S	630	14	G 3/8"	50,0	30,0	17,0	24	27	GAI-S-14-G 3/8"	29,90
S	630	14	G 1/2"	52,0	32,0	20,0	27	27	GAI-S-14-G 1/2"	28,12
S	400	16	G 3/8"	48,0	26,5	17,5	27	30	GAI-S-16-G 3/8"	29,81
S	400	16	G 1/2"	53,0	31,5	20,0	27	30	GAI-S-16-G 1/2"	29,81
S	400	16	G 3/4"	55,0	34,5	22,0	36	30	GAI-S-16-G 3/4"	42,72
S	400	20	G 1/2"	57,0	32,5	20,0	32	36	GAI-S-20-G 1/2"	39,34
S	400	20	G 3/4"	60,0	34,5	22,0	32	36	GAI-S-20-G 3/4"	43,13
S	400	25	G 3/4"	60,0	35,0	22,0	41	46	GAI-S-25-G 3/4"	60,03
S	400	25	G 1"	66,5	37,5	24,5	41	46	GAI-S-25-G 1"	60,03
S	400	30	G 1 1/4"	72,5	42,0	26,5	55	50	GAI-S-30-G 1 1/4"	104,82
S	315	38	G 1 1/2"	79,5	43,5	28,5	60	60	GAI-S-38-G 1 1/2"	127,82

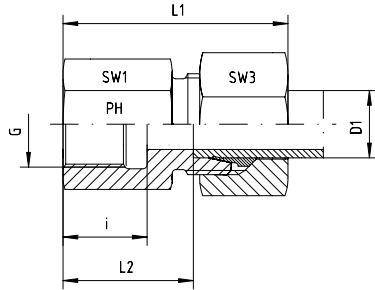

Gerade Aufsraub-Verschraubungen
Innengewinde: Whitworth-Rohrgewinde - Zylindrisch

Female Stud Couplings
Female Thread: BSP - Parallel

Reihe Series	Druck Pressure PN	Rohr A.D. Tube O.D. D1	Gewinde Thread G	Ca. Maße Approx. Dimensions					Bestellzeichen Order-Code SC	Brutto-Preis Gross-Price Euro (€)
				L1	L2	i	SW1	SW3		
L	315	6	G 1/8"	36,0	19,0	12,0	14	14	GAI-L-06-G 1/8"-SC	12,34
L	315	6	G 1/4"	41,0	24,0	17,0	19	14	GAI-L-06-G 1/4"-SC	14,38
L	315	6	G 3/8"	42,0	24,0	17,0	24	14	GAI-L-06-G 3/8"-SC	18,44
L	315	6	G 1/2"	46,0	31,0	20,0	27	14	GAI-L-06-G 1/2"-SC	23,02
L	315	8	G 1/8"	36,0	19,0	12,0	14	17	GAI-L-08-G 1/8"-SC	16,64
L	315	8	G 1/4"	41,0	24,0	17,0	19	17	GAI-L-08-G 1/4"-SC	16,29
L	315	8	G 3/8"	42,0	25,0	17,0	24	17	GAI-L-08-G 3/8"-SC	18,56
L	315	8	G 1/2"	46,0	32,0	20,0	27	17	GAI-L-08-G 1/2"-SC	23,63
L	315	10	G 1/8"	36,0	19,0	12,0	17	19	GAI-L-10-G 1/8"-SC	16,69
L	315	10	G 1/4"	42,0	25,0	17,0	19	19	GAI-L-10-G 1/4"-SC	16,24
L	315	10	G 3/8"	43,0	26,0	17,0	24	19	GAI-L-10-G 3/8"-SC	19,61
L	315	10	G 1/2"	47,0	30,0	20,0	27	19	GAI-L-10-G 1/2"-SC	24,19
L	315	12	G 1/4"	42,0	25,0	17,0	19	22	GAI-L-12-G 1/4"-SC	19,22
L	315	12	G 3/8"	43,0	26,0	17,0	24	22	GAI-L-12-G 3/8"-SC	19,22
L	315	12	G 1/2"	48,0	30,0	20,0	27	22	GAI-L-12-G 1/2"-SC	22,26
L	315	15	G 3/8"	46,0	27,0	17,5	24	27	GAI-L-15-G 3/8"-SC	23,07
L	315	15	G 1/2"	49,0	31,0	20,0	27	27	GAI-L-15-G 1/2"-SC	25,98
L	160	15	G 3/4"	53,0	34,0	22,0	32	27	GAI-L-15-G 3/4"-SC	44,77
L	315	18	G 3/8"	47,0	26,5	17,5	27	32	GAI-L-18-G 3/8"-SC	31,47
L	315	18	G 1/2"	50,5	30,5	20,0	27	32	GAI-L-18-G 1/2"-SC	31,47
L	160	18	G 3/4"	53,5	33,5	22,0	36	32	GAI-L-18-G 3/4"-SC	44,77
L	160	22	G 1/2"	55,0	33,5	20,0	32	36	GAI-L-22-G 1/2"-SC	41,97
L	160	22	G 3/4"	56,0	35,5	22,0	36	36	GAI-L-22-G 3/4"-SC	40,16
L	160	28	G 3/4"	57,5	35,0	22,0	41	41	GAI-L-28-G 3/4"-SC	71,20
L	160	28	G 1"	60,5	38,0	24,5	41	41	GAI-L-28-G 1"-SC	56,15
L	160	35	G 1 1/4"	68,5	41,0	26,5	55	50	GAI-L-35-G 1 1/4"-SC	93,20
L	160	42	G 1 1/2"	69,5	42,5	28,5	60	60	GAI-L-42-G 1 1/2"-SC	116,81

Reihe Series	Druck Pressure PN	Rohr A.D. Tube O.D. D1	Gewinde Thread G	Ca. Maße Approx. Dimensions					Bestellzeichen Order-Code SC	Brutto-Preis Gross-Price Euro (€)
				L1	L2	i	SW1	SW3		
S	630	6	G 1/4"	42,0	26,0	17,0	19	17	GAI-S-06-G 1/4"-SC	16,37
S	630	6	G 3/8"			17,0	24	17	GAI-S-06-G 3/8"-SC	*
S	630	6	G 1/2"	48,0	31,0	20,0	27	17	GAI-S-06-G 1/2"-SC	*
S	630	8	G 1/4"	43,0	26,0	17,0	19	19	GAI-S-08-G 1/4"-SC	16,75
S	630	8	G 3/8"	44,0	27,0	17,0	24	19	GAI-S-08-G 3/8"-SC	22,24
S	630	8	G 1/2"	48,0	31,0	20,0	27	19	GAI-S-08-G 1/2"-SC	24,14
S	630	10	G 3/8"	45,0	26,5	17,0	24	22	GAI-S-10-G 3/8"-SC	22,03
S	630	10	G 1/2"	49,5	30,5	20,0	27	22	GAI-S-10-G 1/2"-SC	24,08
S	630	12	G 1/4"	46,0	27,5	17,0	22	24	GAI-S-12-G 1/4"-SC	23,85
S	630	12	G 3/8"	45,0	26,5	17,0	24	24	GAI-S-12-G 3/8"-SC	23,21
S	630	12	G 1/2"	50,0	30,5	20,0	27	24	GAI-S-12-G 1/2"-SC	24,36
S	630	14	G 3/8"	50,0	30,0	17,0	24	27	GAI-S-14-G 3/8"-SC	*
S	630	14	G 1/2"	52,0	32,0	20,0	27	27	GAI-S-14-G 1/2"-SC	29,68
S	400	16	G 3/8"	48,0	26,5	17,5	27	30	GAI-S-16-G 3/8"-SC	31,37
S	400	16	G 1/2"	53,0	31,5	20,0	27	30	GAI-S-16-G 1/2"-SC	31,37
S	400	16	G 3/4"	55,0	34,5	22,0	36	30	GAI-S-16-G 3/4"-SC	66,64
S	400	20	G 1/2"	57,0	32,5	20,0	32	36	GAI-S-20-G 1/2"-SC	41,22
S	400	20	G 3/4"	60,0	34,5	22,0	32	36	GAI-S-20-G 3/4"-SC	45,01
S	400	25	G 3/4"	60,0	35,0	22,0	41	46	GAI-S-25-G 3/4"-SC	63,03
S	400	25	G 1"	66,5	37,5	24,5	41	46	GAI-S-25-G 1"-SC	63,03
S	400	30	G 1 1/4"	72,5	42,0	26,5	55	50	GAI-S-30-G 1 1/4"-SC	108,98
S	315	38	G 1 1/2"	79,5	43,5	28,5	60	60	GAI-S-38-G 1 1/2"-SC	133,46

Gerade Aufschraub-Verschraubungsstutzen
Innengewinde: Whitworth-Rohrgewinde - Zylindrisch

Female Stud Coupling Bodies
Female Thread: BSP - Parallel



Reihe Series	Druck Pressure PN	Rohr A.D. Tube O.D. D1	Gewinde Thread G	Ca. Maße Approx. Dimensions				Bestellzeichen Order-Code OMD	Brutto-Preis Gross-Price Euro (€)
L	315	6	G 1/8"					GAI-L-06-G 1/8"-OMD	9,71
L	315	6	G 1/4"					GAI-L-06-G 1/4"-OMD	11,75
L	315	6	G 3/8"					GAI-L-06-G 3/8"-OMD	15,81
L	315	6	G 1/2"					GAI-L-06-G 1/2"-OMD	20,39
L	315	8	G 1/8"					GAI-L-08-G 1/8"-OMD	13,40
L	315	8	G 1/4"					GAI-L-08-G 1/4"-OMD	13,05
L	315	8	G 3/8"					GAI-L-08-G 3/8"-OMD	15,32
L	315	8	G 1/2"					GAI-L-08-G 1/2"-OMD	20,39
L	315	10	G 1/8"					GAI-L-10-G 1/8"-OMD	12,89
L	315	10	G 1/4"					GAI-L-10-G 1/4"-OMD	12,44
L	315	10	G 3/8"					GAI-L-10-G 3/8"-OMD	15,81
L	315	10	G 1/2"					GAI-L-10-G 1/2"-OMD	20,39
L	315	12	G 1/4"					GAI-L-12-G 1/4"-OMD	14,77
L	315	12	G 3/8"					GAI-L-12-G 3/8"-OMD	14,77
L	315	12	G 1/2"					GAI-L-12-G 1/2"-OMD	17,81
L	315	15	G 3/8"					GAI-L-15-G 3/8"-OMD	16,85
L	315	15	G 1/2"					GAI-L-15-G 1/2"-OMD	19,76
L	160	15	G 3/4"					GAI-L-15-G 3/4"-OMD	34,51
L	315	18	G 3/8"					GAI-L-18-G 3/8"-OMD	21,21
L	315	18	G 1/2"					GAI-L-18-G 1/2"-OMD	21,21
L	160	18	G 3/4"					GAI-L-18-G 3/4"-OMD	34,51
L	160	22	G 1/2"					GAI-L-22-G 1/2"-OMD	29,90
L	160	22	G 3/4"					GAI-L-22-G 3/4"-OMD	28,09
L	160	28	G 3/4"					GAI-L-28-G 3/4"-OMD	54,35
L	160	28	G 1"					GAI-L-28-G 1"-OMD	39,30
L	160	35	G 1 1/4"					GAI-L-35-G 1 1/4"-OMD	68,37
L	160	42	G 1 1/2"					GAI-L-42-G 1 1/2"-OMD	85,06

Reihe Series	Druck Pressure PN	Rohr A.D. Tube O.D. D1	Gewinde Thread G	Ca. Maße Approx. Dimensions				Bestellzeichen Order-Code OMD	Brutto-Preis Gross-Price Euro (€)
S	630	6	G 1/4"					GAI-S-06-G 1/4"-OMD	13,14
S	630	6	G 3/8"					GAI-S-06-G 3/8"-OMD	*
S	630	6	G 1/2"					GAI-S-06-G 1/2"-OMD	*
S	630	8	G 1/4"					GAI-S-08-G 1/4"-OMD	13,11
S	630	8	G 3/8"					GAI-S-08-G 3/8"-OMD	18,60
S	630	8	G 1/2"					GAI-S-08-G 1/2"-OMD	20,50
S	630	10	G 3/8"					GAI-S-10-G 3/8"-OMD	17,53
S	630	10	G 1/2"					GAI-S-10-G 1/2"-OMD	19,58
S	630	12	G 1/4"					GAI-S-12-G 1/4"-OMD	18,56
S	630	12	G 3/8"					GAI-S-12-G 3/8"-OMD	17,92
S	630	12	G 1/2"					GAI-S-12-G 1/2"-OMD	19,07
S	630	14	G 3/8"					GAI-S-14-G 3/8"-OMD	24,40
S	630	14	G 1/2"					GAI-S-14-G 1/2"-OMD	22,62
S	400	16	G 3/8"					GAI-S-16-G 3/8"-OMD	21,60
S	400	16	G 1/2"					GAI-S-16-G 1/2"-OMD	21,60
S	400	16	G 3/4"					GAI-S-16-G 3/4"-OMD	34,51
S	400	20	G 1/2"					GAI-S-20-G 1/2"-OMD	28,76
S	400	20	G 3/4"					GAI-S-20-G 3/4"-OMD	32,55
S	400	25	G 3/4"					GAI-S-25-G 3/4"-OMD	41,41
S	400	25	G 1"					GAI-S-25-G 1"-OMD	41,41
S	400	30	G 1 1/4"					GAI-S-30-G 1 1/4"-OMD	81,38
S	315	38	G 1 1/2"					GAI-S-38-G 1 1/2"-OMD	96,01

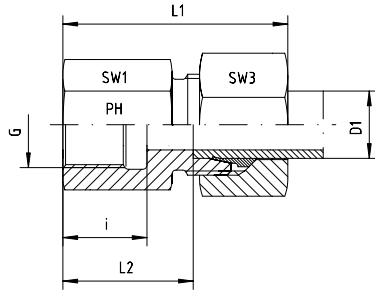

Gerade Aufschraub-Verschraubungen
Innengewinde: Metrisches Feingewinde - Zylindrisch

Female Stud Couplings
Female Thread: Metric - Parallel

Reihe Series	Druck Pressure PN	Rohr A.D. Tube O.D. D1	Gewinde Thread G	Ca. Maße Approx. Dimensions					Bestellzeichen Order-Code Standard	Brutto-Preis Gross-Price Euro (€)
				L1	L2	i	SW1	SW3		
L	315	6	M 10 x 1	34	19,5	12,5	14	14	GAI-L-06-M 10x1	14,11
L	315	8	M 12 x 1,5	39	24,0	17,0	17	17	GAI-L-08-M 12x1,5	16,62
L	315	10	M 14 x 1,5	40	25,0	17,0	19	19	GAI-L-10-M 14x1,5	19,45
L	315	12	M 16 x 1,5	41	26,0	17,0	22	22	GAI-L-12-M 16x1,5	23,16
L	315	15	M 18 x 1,5	43	28,0	17,0	24	27	GAI-L-15-M 18x1,5	32,85
L	315	18	M 22 x 1,5	46	29,5	19,0	30	32	GAI-L-18-M 22x1,5	35,59
L	160	22	M 26 x 1,5	51	34,5	21,0	32	36	GAI-L-22-M 26x1,5	42,08
L	160	28	M 33 x 2	54	37,5	24,0	41	41	GAI-L-28-M 33x2	61,36
L	160	35	M 42 x 2	62	40,5	26,0	50	50	GAI-L-35-M 42x2	103,79
L	160	42	M 48 x 2	65	42,0	28,0	55	60	GAI-L-42-M 48x2	137,74

Reihe Series	Druck Pressure PN	Rohr A.D. Tube O.D. D1	Gewinde Thread G	Ca. Maße Approx. Dimensions					Bestellzeichen Order-Code Standard	Brutto-Preis Gross-Price Euro (€)
				L1	L2	i	SW1	SW3		
S	630	6	M 12 x 1,5	41	26,0	17,0	17	17	GAI-S-06-M 12x1,5	16,82
S	630	8	M 14 x 1,5	41	26,0	17,0	19	19	GAI-S-08-M 14x1,5	19,15
S	630	10	M 16 x 1,5	43	26,5	17,0	22	22	GAI-S-10-M 16x1,5	23,32
S	630	12	M 18 x 1,5	44	27,5	17,0	24	24	GAI-S-12-M 18x1,5	27,56
S	630	14	M 20 x 1,5	49	31,0	19,0	27	27	GAI-S-14-M 20x1,5	33,49
S	400	16	M 22 x 1,5	49	30,5	19,0	30	30	GAI-S-16-M 22x1,5	36,76
S	400	20	M 27 x 2	56	34,5	22,0	32	36	GAI-S-20-M 27x2	47,04
S	400	25	M 33 x 2	61	37,0	24,0	41	46	GAI-S-25-M 33x2	65,96
S	400	30	M 42 x 2	68	41,5	26,0	50	50	GAI-S-30-M 42x2	108,40
S	315	38	M 48 x 2	74	43,0	28,0	55	60	GAI-S-38-M 48x2	140,10

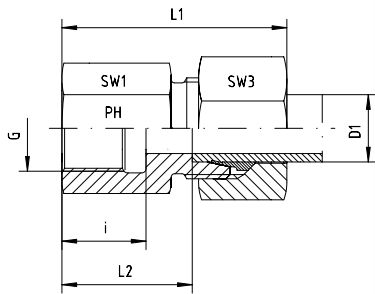

Gerade Aufsraub-Verschraubungen
Innengewinde: Metrisches Feingewinde - Zylindrisch

Female Stud Couplings
Female Thread: Metric - Parallel

Reihe Series	Druck Pressure PN	Rohr A.D. Tube O.D. D1	Gewinde Thread G	Ca. Maße Approx. Dimensions					Bestellzeichen Order-Code SC	Brutto-Preis Gross-Price Euro (€)
				L1	L2	i	SW1	SW3		
L	315	6	M 10 x 1	34	19,5	12,5	14	14	GAI-L-06-M 10x1-SC	14,43
L	315	8	M 12 x 1,5	39	24,0	17,0	17	17	GAI-L-08-M 12x1,5-SC	17,06
L	315	10	M 14 x 1,5	40	25,0	17,0	19	19	GAI-L-10-M 14x1,5-SC	19,89
L	315	12	M 16 x 1,5	41	26,0	17,0	22	22	GAI-L-12-M 16x1,5-SC	23,72
L	315	15	M 18 x 1,5	43	28,0	17,0	24	27	GAI-L-15-M 18x1,5-SC	33,93
L	315	18	M 22 x 1,5	46	29,5	19,0	30	32	GAI-L-18-M 22x1,5-SC	37,23
L	160	22	M 26 x 1,5	51	34,5	21,0	32	36	GAI-L-22-M 26x1,5-SC	43,84
L	160	28	M 33 x 2	54	37,5	24,0	41	41	GAI-L-28-M 33x2-SC	63,36
L	160	35	M 42 x 2	62	40,5	26,0	50	50	GAI-L-35-M 42x2-SC	107,51
L	160	42	M 48 x 2	65	42,0	28,0	55	60	GAI-L-42-M 48x2-SC	142,06

Reihe Series	Druck Pressure PN	Rohr A.D. Tube O.D. D1	Gewinde Thread G	Ca. Maße Approx. Dimensions					Bestellzeichen Order-Code SC	Brutto-Preis Gross-Price Euro (€)
				L1	L2	i	SW1	SW3		
S	630	6	M 12 x 1,5	41	26,0	17,0	17	17	GAI-S-06-M 12x1,5-SC	17,26
S	630	8	M 14 x 1,5	41	26,0	17,0	19	19	GAI-S-08-M 14x1,5-SC	19,59
S	630	10	M 16 x 1,5	43	26,5	17,0	22	22	GAI-S-10-M 16x1,5-SC	23,88
S	630	12	M 18 x 1,5	44	27,5	17,0	24	24	GAI-S-12-M 18x1,5-SC	28,40
S	630	14	M 20 x 1,5	49	31,0	19,0	27	27	GAI-S-14-M 20x1,5-SC	35,05
S	400	16	M 22 x 1,5	49	30,5	19,0	30	30	GAI-S-16-M 22x1,5-SC	38,32
S	400	20	M 27 x 2	56	34,5	22,0	32	36	GAI-S-20-M 27x2-SC	48,92
S	400	25	M 33 x 2	61	37,0	24,0	41	46	GAI-S-25-M 33x2-SC	68,96
S	400	30	M 42 x 2	68	41,5	26,0	50	50	GAI-S-30-M 42x2-SC	112,56
S	315	38	M 48 x 2	74	43,0	28,0	55	60	GAI-S-38-M 48x2-SC	145,74

Gerade Aufsraub-Verschraubungsstutzen
Innengewinde: Metrisches Feingewinde - Zylindrisch

Female Stud Coupling Bodies
Female Thread: Metric - Parallel



Reihe Series	Druck Pressure PN	Rohr A.D. Tube O.D. D1	Gewinde Thread G	Ca. Maße Approx. Dimensions				Bestellzeichen Order-Code OMD	Brutto-Preis Gross-Price Euro (€)
L	315	6	M 10 x 1					GAI-L-06-M 10x1-OMD	11,80
L	315	8	M 12 x 1,5					GAI-L-08-M 12x1,5-OMD	13,82
L	315	10	M 14 x 1,5					GAI-L-10-M 14x1,5-OMD	16,09
L	315	12	M 16 x 1,5					GAI-L-12-M 16x1,5-OMD	19,27
L	315	15	M 18 x 1,5					GAI-L-15-M 18x1,5-OMD	27,71
L	315	18	M 22 x 1,5					GAI-L-18-M 22x1,5-OMD	26,97
L	160	22	M 26 x 1,5					GAI-L-22-M 26x1,5-OMD	31,77
L	160	28	M 33 x 2					GAI-L-28-M 33x2-OMD	46,51
L	160	35	M 42 x 2					GAI-L-35-M 42x2-OMD	82,68
L	160	42	M 48 x 2					GAI-L-42-M 48x2-OMD	110,31

Reihe Series	Druck Pressure PN	Rohr A.D. Tube O.D. D1	Gewinde Thread G	Ca. Maße Approx. Dimensions				Bestellzeichen Order-Code OMD	Brutto-Preis Gross-Price Euro (€)
S	630	6	M 12 x 1,5					GAI-S-06-M 12x1,5-OMD	14,03
S	630	8	M 14 x 1,5					GAI-S-08-M 14x1,5-OMD	15,95
S	630	10	M 16 x 1,5					GAI-S-10-M 16x1,5-OMD	19,38
S	630	12	M 18 x 1,5					GAI-S-12-M 18x1,5-OMD	23,11
S	630	14	M 20 x 1,5					GAI-S-14-M 20x1,5-OMD	27,99
S	400	16	M 22 x 1,5					GAI-S-16-M 22x1,5-OMD	28,55
S	400	20	M 27 x 2					GAI-S-20-M 27x2-OMD	36,46
S	400	25	M 33 x 2					GAI-S-25-M 33x2-OMD	47,34
S	400	30	M 42 x 2					GAI-S-30-M 42x2-OMD	84,96
S	315	38	M 48 x 2					GAI-S-38-M 48x2-OMD	108,29

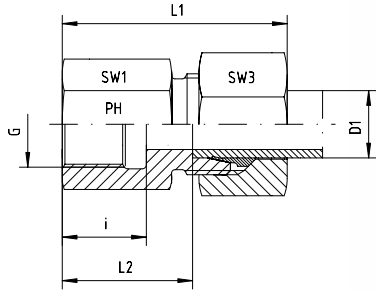

Gerade Aufsraub-Verschraubungen
Innengewinde: NPT

Female Stud Couplings
Female Thread: NPT

Reihe Series	Druck Pressure PN	Rohr A.D. Tube O.D. D1	Gewinde Thread G	Ca. Maße Approx. Dimensions					Bestellzeichen Order-Code Standard	Brutto-Preis Gross-Price Euro (€)
				L1	L2	i	SW1	SW3		
L	315	6	1/8" NPT	34	19,0	11,6	14	14	GAI-L-06-1/8"-NPT	16,71
L	315	6	1/4" NPT	38	23,5	16,4	19	14	GAI-L-06-1/4"-NPT	16,71
L	315	6	3/8" NPT			17,4	24	14	GAI-L-06-3/8"-NPT	*
L	315	8	1/4" NPT	38	23,5	16,4	19	17	GAI-L-08-1/4"-NPT	17,40
L	315	8	3/8" NPT			17,4	24	17	GAI-L-08-3/8"-NPT	*
L	315	10	1/4" NPT	39	24,0	16,4	19	19	GAI-L-10-1/4"-NPT	17,96
L	315	10	3/8" NPT	43	26,0	17,4	24	19	GAI-L-10-3/8"-NPT	21,89
L	315	10	1/2" NPT			22,6	27	19	GAI-L-10-1/2"-NPT	22,11
L	315	12	1/4" NPT			16,4	19	22	GAI-L-12-1/4"-NPT	18,49
L	315	12	3/8" NPT	42	27,0	17,4	24	22	GAI-L-12-3/8"-NPT	21,89
L	315	12	1/2" NPT	47	32,0	22,6	27	22	GAI-L-12-1/2"-NPT	23,01
L	315	15	3/8" NPT			17,4	24	27	GAI-L-15-3/8"-NPT	*
L	315	15	1/2" NPT	48	33,0	22,6	27	27	GAI-L-15-1/2"-NPT	29,89
L	315	18	1/2" NPT	49	32,5	22,6	27	27	GAI-L-18-1/2"-NPT	35,22
L	160	22	3/4" NPT	52	35,5	23,1	36	36	GAI-L-22-3/4"-NPT	62,51
L	160	28	1" NPT	57	40,5	27,8	41	41	GAI-L-28-1"-NPT	88,50
L	160	35	1 1/4" NPT	62	40,5	28,3	55	50	GAI-L-35-1 1/4"-NPT	121,06
L	160	42	1 1/2" NPT	65	42,0	28,3	60	60	GAI-L-42-1 1/2"-NPT	140,83

Reihe Series	Druck Pressure PN	Rohr A.D. Tube O.D. D1	Gewinde Thread G	Ca. Maße Approx. Dimensions					Bestellzeichen Order-Code Standard	Brutto-Preis Gross-Price Euro (€)
				L1	L2	i	SW1	SW3		
S	630	6	1/4" NPT	41	26,0	16,4	19	17	GAI-S-06-1/4"-NPT	19,04
S	630	8	1/4" NPT	41	26,0	16,4	19	19	GAI-S-08-1/4"-NPT	19,70
S	630	10	3/8" NPT	44	27,0	17,4	24	22	GAI-S-10-3/8"-NPT	21,94
S	630	12	3/8" NPT	44	27,5	17,4	24	24	GAI-S-12-3/8"-NPT	23,35
S	630	12	1/2" NPT	50	33,5	22,6	27	24	GAI-S-12-1/2"-NPT	31,05
S	630	14	1/2" NPT	53	35,0	22,6	27	27	GAI-S-14-1/2"-NPT	34,81
S	400	16	3/8" NPT	48	27,5	17,4	27	30	GAI-S-16-3/8"-NPT	34,81
S	400	16	1/2" NPT	50	34,5	22,6	27	30	GAI-S-16-1/2"-NPT	34,81
S	400	20	3/4" NPT	57	35,5	23,1	32	36	GAI-S-20-3/4"-NPT	68,48
S	400	25	1" NPT	65	41,0	27,8	41	46	GAI-S-25-1"-NPT	98,52
S	400	30	1 1/4" NPT	70	43,5	28,3	55	50	GAI-S-30-1 1/4"-NPT	147,00
S	315	38	1 1/2" NPT	74	43,0	28,3	60	60	GAI-S-38-1 1/2"-NPT	158,90

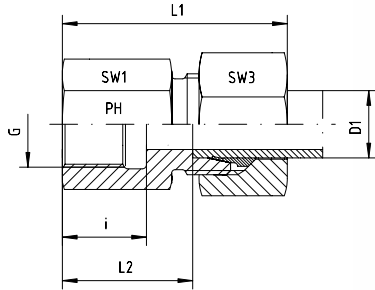

Gerade Aufsraub-Verschraubungen
Innengewinde: NPT

Female Stud Couplings
Female Thread: NPT

Reihe Series	Druck Pressure PN	Rohr A.D. Tube O.D. D1	Gewinde Thread G	Ca. Maße Approx. Dimensions					Bestellzeichen Order-Code SC	Brutto-Preis Gross-Price Euro (€)
				L1	L2	i	SW1	SW3		
L	315	6	1/8" NPT	34	19,0	11,6	14	14	GAI-L-06-1/8"-NPT-SC	17,03
L	315	6	1/4" NPT	38	23,5	16,4	19	14	GAI-L-06-1/4"-NPT-SC	17,03
L	315	6	3/8" NPT			17,4	24	14	GAI-L-06-3/8"-NPT-SC	*
L	315	8	1/4" NPT	38	23,5	16,4	19	17	GAI-L-08-1/4"-NPT-SC	17,84
L	315	8	3/8" NPT			17,4	24	17	GAI-L-08-3/8"-NPT-SC	*
L	315	10	1/4" NPT	39	24,0	16,4	19	19	GAI-L-10-1/4"-NPT-SC	18,40
L	315	10	3/8" NPT			17,4	24	19	GAI-L-10-3/8"-NPT-SC	22,45
L	315	10	1/2" NPT			22,6	27	19	GAI-L-10-1/2"-NPT-SC	22,55
L	315	12	1/4" NPT			16,4	19	22	GAI-L-12-1/4"-NPT-SC	19,05
L	315	12	3/8" NPT	42	27,0	17,4	24	22	GAI-L-12-3/8"-NPT-SC	22,45
L	315	12	1/2" NPT	47	32,0	22,6	27	22	GAI-L-12-1/2"-NPT-SC	23,57
L	315	15	3/8" NPT			17,4	24	27	GAI-L-15-3/8"-NPT-SC	*
L	315	15	1/2" NPT	48	33,0	22,6	27	27	GAI-L-15-1/2"-NPT-SC	30,97
L	315	18	1/2" NPT	49	32,5	22,6	27	27	GAI-L-18-1/2"-NPT-SC	36,86
L	160	22	3/4" NPT	52	35,5	23,1	36	36	GAI-L-22-3/4"-NPT-SC	64,27
L	160	28	1" NPT	57	40,5	27,8	41	41	GAI-L-28-1"-NPT-SC	90,50
L	160	35	1 1/4" NPT	62	40,5	28,3	55	50	GAI-L-35-1 1/4"-NPT-SC	124,78
L	160	42	1 1/2" NPT	65	42,0	28,3	60	60	GAI-L-42-1 1/2"-NPT-SC	145,15

Reihe Series	Druck Pressure PN	Rohr A.D. Tube O.D. D1	Gewinde Thread G	Ca. Maße Approx. Dimensions					Bestellzeichen Order-Code SC	Brutto-Preis Gross-Price Euro (€)
				L1	L2	i	SW1	SW3		
S	630	6	1/4" NPT	41	26,0	16,4	19	17	GAI-S-06-1/4"-NPT-SC	19,48
S	630	8	1/4" NPT	41	26,0	16,4	19	19	GAI-S-08-1/4"-NPT-SC	20,14
S	630	10	3/8" NPT	44	27,0	17,4	24	22	GAI-S-10-3/8"-NPT-SC	22,50
S	630	12	3/8" NPT	44	27,5	17,4	24	24	GAI-S-12-3/8"-NPT-SC	24,19
S	630	12	1/2" NPT	50	33,5	22,6	27	24	GAI-S-12-1/2"-NPT-SC	31,89
S	630	14	1/2" NPT	53	35,0	22,6	27	27	GAI-S-14-1/2"-NPT-SC	*
S	400	16	3/8" NPT	48	27,5	17,4	27	30	GAI-S-16-3/8"-NPT-SC	36,37
S	400	16	1/2" NPT	50	34,5	22,6	27	30	GAI-S-16-1/2"-NPT-SC	36,37
S	400	20	3/4" NPT	57	35,5	23,1	32	36	GAI-S-20-3/4"-NPT-SC	70,36
S	400	25	1" NPT	65	41,0	27,8	41	46	GAI-S-25-1"-NPT-SC	101,52
S	400	30	1 1/4" NPT	70	43,5	28,3	55	50	GAI-S-30-1 1/4"-NPT-SC	*
S	315	38	1 1/2" NPT	74	43,0	28,3	60	60	GAI-S-38-1 1/2"-NPT-SC	164,54

Gerade Aufsraub-Verschraubungsstutzen
Innengewinde: NPT

Female Stud Coupling Bodies
Female Thread: NPT



Reihe Series	Druck Pressure PN	Rohr A.D. Tube O.D. D1	Gewinde Thread G	Ca. Maße Approx. Dimensions					Bestellzeichen Order-Code OMD	Brutto-Preis Gross-Price Euro (€)
L	315	6	1/8" NPT						GAI-L-06-1/8"-NPT-OMD	14,40
L	315	6	1/4" NPT						GAI-L-06-1/4"-NPT-OMD	14,40
L	315	6	3/8" NPT						GAI-L-06-3/8"-NPT-OMD	*
L	315	8	1/4" NPT						GAI-L-08-1/4"-NPT-OMD	14,60
L	315	8	3/8" NPT						GAI-L-08-3/8"-NPT-OMD	*
L	315	10	1/4" NPT						GAI-L-10-1/4"-NPT-OMD	14,60
L	315	10	3/8" NPT						GAI-L-10-3/8"-NPT-OMD	18,53
L	315	10	1/2" NPT						GAI-L-10-1/2"-NPT-OMD	18,75
L	315	12	1/4" NPT						GAI-L-12-1/4"-NPT-OMD	14,60
L	315	12	3/8" NPT						GAI-L-12-3/8"-NPT-OMD	18,00
L	315	12	1/2" NPT						GAI-L-12-1/2"-NPT-OMD	19,12
L	315	15	3/8" NPT						GAI-L-15-3/8"-NPT-OMD	*
L	315	15	1/2" NPT						GAI-L-15-1/2"-NPT-OMD	24,75
L	315	18	1/2" NPT						GAI-L-18-1/2"-NPT-OMD	26,60
L	160	22	3/4" NPT						GAI-L-22-3/4"-NPT-OMD	52,20
L	160	28	1" NPT						GAI-L-28-1"-NPT-OMD	73,65
L	160	35	1 1/4" NPT						GAI-L-35-1 1/4"-NPT-OMD	99,95
L	160	42	1 1/2" NPT						GAI-L-42-1 1/2"-NPT-OMD	113,40

Reihe Series	Druck Pressure PN	Rohr A.D. Tube O.D. D1	Gewinde Thread G	Ca. Maße Approx. Dimensions					Bestellzeichen Order-Code OMD	Brutto-Preis Gross-Price Euro (€)
S	630	6	1/4" NPT						GAI-S-06-1/4"-NPT-OMD	16,25
S	630	8	1/4" NPT						GAI-S-08-1/4"-NPT-OMD	16,50
S	630	10	3/8" NPT						GAI-S-10-3/8"-NPT-OMD	18,00
S	630	12	3/8" NPT						GAI-S-12-3/8"-NPT-OMD	18,90
S	630	12	1/2" NPT						GAI-S-12-1/2"-NPT-OMD	26,60
S	630	14	1/2" NPT						GAI-S-14-1/2"-NPT-OMD	29,31
S	400	16	3/8" NPT						GAI-S-16-3/8"-NPT-OMD	26,60
S	400	16	1/2" NPT						GAI-S-16-1/2"-NPT-OMD	26,60
S	400	20	3/4" NPT						GAI-S-20-3/4"-NPT-OMD	57,90
S	400	25	1" NPT						GAI-S-25-1"-NPT-OMD	79,90
S	400	30	1 1/4" NPT						GAI-S-30-1 1/4"-NPT-OMD	123,56
S	315	38	1 1/2" NPT						GAI-S-38-1 1/2"-NPT-OMD	127,09

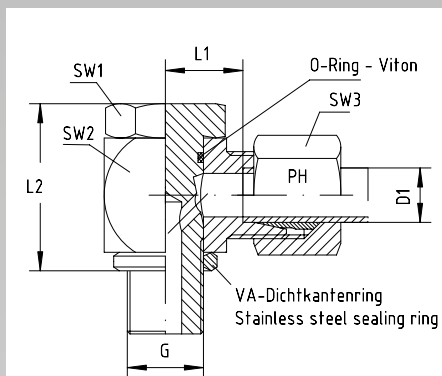

Winkel-Schwenkverschraubungen

Mit VA-Dichtkantenring für Ausdrehung DIN 3852 (schmal)
Hohlschraube muss vor der Montage geschmiert werden
(siehe Allgemeine Informationen Rubrik 1)

Auf Anfrage: Mit gekammertem Weichdichtung -
Rubrik 8.255 und 8.256

Einschraubgewinde G: Whitworth-Rohrgewinde - Zylindrisch

Banjo Elbows

With Stainless Steel Sealing Ring for DIN 3853 (small)

Banjo Bolt must be greased prior to assembly (see General
Information Category 1)

On Request: With Bonded Seal Ring - Category 8.255 and 8.256
Thread G: BSP - Parallel

Reihe Series	Druck Pressure PN	Rohr A.D. Tube O.D. D1	Gewinde Thread G	Ca. Maße Approx. Dimensions					Bestellzeichen Order-Code Standard	Brutto-Preis Gross-Price Euro (€)
				L1	L2	SW1	SW2	SW3		
LL	100	4	G 1/8"	11,0	24	17	18	10	WHV-LL-04-G 1/8"	77,46
LL	100	6	G 1/8"	11,5	24	17	18	12	WHV-LL-06-G 1/8"	77,46
LL	100	8	G 1/8"	11,5	24	17	18	14	WHV-LL-08-G 1/8"	79,15

Reihe Series	Druck Pressure PN	Rohr A.D. Tube O.D. D1	Gewinde Thread G	Ca. Maße Approx. Dimensions					Bestellzeichen Order-Code Standard	Brutto-Preis Gross-Price Euro (€)
				L1	L2	SW1	SW2	SW3		
L	500	6	G 1/8"	12,0	24	17	18	14	WHV-L-06-G 1/8"	76,69
L	400	8	G 1/4"	14,5	30	19	22	17	WHV-L-08-G 1/4"	81,81
L	350	10	G 1/4"	15,5	30	19	22	19	WHV-L-10-G 1/4"	89,48
L	350	10	G 3/8"	17,5	35	24	27	19	WHV-L-10-G 3/8"	117,40
L	350	12	G 1/4"	15,5	30	19	22	22	WHV-L-12-G 1/4"	117,40
L	350	12	G 3/8"	18,0	36	24	27	22	WHV-L-12-G 3/8"	107,37
L	315	12	G 1/2"	21,5	45	30	32	22	WHV-L-12-G 1/2"	130,38
L	315	15	G 1/2"	21,5	45	30	32	27	WHV-L-15-G 1/2"	130,38
L	315	18	G 1/2"	21,0	45	30	32	32	WHV-L-18-G 1/2"	166,17
L	200	22	G 3/4"	27,5	53	36	40	36	WHV-L-22-G 3/4"	258,21
L	200	28	G 1"	32,0	66	46	50	41	WHV-L-28-G 1"	383,47
L	200	35	G 1 1/4"	36,0	76	55	60	50	WHV-L-35-G 1 1/4"	567,54
L	200	42	G 1 1/2"	40,5	87	60	70	60	WHV-L-42-G 1 1/2"	802,74

Reihe Series	Druck Pressure PN	Rohr A.D. Tube O.D. D1	Gewinde Thread G	Ca. Maße Approx. Dimensions					Bestellzeichen Order-Code Standard	Brutto-Preis Gross-Price Euro (€)
				L1	L2	SW1	SW2	SW3		
S	500	6	G 1/4"	16,5	30	19	22	17	WHV-S-06-G 1/4"	84,36
S	450	8	G 1/4"	16,5	30	19	22	19	WHV-S-08-G 1/4"	92,03
S	400	10	G 1/4"	16,5	30	19	22	22	WHV-S-10-G 1/4"	115,90
S	400	10	G 3/8"	18,5	36	24	27	22	WHV-S-10-G 3/8"	104,82
S	400	12	G 3/8"	18,5	36	24	27	24	WHV-S-12-G 3/8"	117,60
S	400	14	G 1/2"	22,5	45	30	32	27	WHV-S-14-G 1/2"	138,05
S	400	16	G 1/2"	22,0	45	30	32	30	WHV-S-16-G 1/2"	171,29
S	400	20	G 3/4"	26,5	53	36	40	36	WHV-S-20-G 3/4"	260,76
S	250	25	G 1"	31,5	66	46	50	46	WHV-S-25-G 1"	411,60
S	250	30	G 1 1/4"	37,0	76	55	60	50	WHV-S-30-G 1 1/4"	608,45
S	250	38	G 1 1/2"	41,5	87	60	70	60	WHV-S-38-G 1 1/2"	856,43

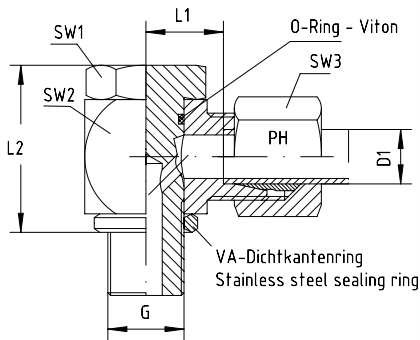

Winkel-Schwenkverschraubungen

Mit VA-Dichtkantenring für Ausdrehung DIN 3852 (schmal)
Hohlschraube muss vor der Montage geschmiert werden
(siehe Allgemeine Informationen Rubrik 1)

Auf Anfrage: Mit gekammertem Weichdichtring -
Rubrik 8.255 und 8.256

Einschraubgewinde G: Whitworth-Rohrgewinde - Zylindrisch

Banjo Elbows

With Stainless Steel Sealing Ring for DIN 3853 (small)

Banjo Bolt must be greased prior to assembly (see General
Information Category 1)

On Request: With Bonded Seal Ring - Category 8.255 and 8.256
Thread G: BSP - Parallel

Reihe Series	Druck Pressure PN	Rohr A.D. Tube O.D. D1	Gewinde Thread G	Ca. Maße Approx. Dimensions					Bestellzeichen Order-Code SC	Brutto-Preis Gross-Price Euro (€)
				L1	L2	SW1	SW2	SW3		
L	500	6	G 1/8"	12,0	24	17	18	14	WHV-L-06-G 1/8"-SC	77,01
L	400	8	G 1/4"	14,5	30	19	22	17	WHV-L-08-G 1/4"-SC	82,25
L	350	10	G 1/4"	15,5	30	19	22	19	WHV-L-10-G 1/4"-SC	89,92
L	350	10	G 3/8"	17,5	35	24	27	19	WHV-L-10-G 3/8"-SC	117,96
L	350	12	G 1/4"	15,5	30	19	22	22	WHV-L-12-G 1/4"-SC	117,96
L	350	12	G 3/8"	18,0	36	24	27	22	WHV-L-12-G 3/8"-SC	107,93
L	315	12	G 1/2"	21,5	45	30	32	22	WHV-L-12-G 1/2"-SC	131,46
L	315	15	G 1/2"	21,5	45	30	32	27	WHV-L-15-G 1/2"-SC	131,46
L	315	18	G 1/2"	21,0	45	30	32	32	WHV-L-18-G 1/2"-SC	167,81
L	200	22	G 3/4"	27,5	53	36	40	36	WHV-L-22-G 3/4"-SC	259,97
L	200	28	G 1"	32,0	66	46	50	41	WHV-L-28-G 1"-SC	385,47
L	200	35	G 1 1/4"	36,0	76	55	60	50	WHV-L-35-G 1 1/4"-SC	571,26
L	200	42	G 1 1/2"	40,5	87	60	70	60	WHV-L-42-G 1 1/2"-SC	807,06

Reihe Series	Druck Pressure PN	Rohr A.D. Tube O.D. D1	Gewinde Thread G	Ca. Maße Approx. Dimensions					Bestellzeichen Order-Code SC	Brutto-Preis Gross-Price Euro (€)
				L1	L2	SW1	SW2	SW3		
S	500	6	G 1/4"	16,5	30	19	22	17	WHV-S-06-G 1/4"-SC	84,80
S	450	8	G 1/4"	16,5	30	19	22	19	WHV-S-08-G 1/4"-SC	92,47
S	400	10	G 1/4"	16,5	30	19	22	22	WHV-S-10-G 1/4"-SC	116,46
S	400	10	G 3/8"	18,5	36	24	27	22	WHV-S-10-G 3/8"-SC	105,38
S	400	12	G 3/8"	18,5	36	24	27	24	WHV-S-12-G 3/8"-SC	118,44
S	400	14	G 1/2"	22,5	45	30	32	27	WHV-S-14-G 1/2"-SC	139,61
S	400	16	G 1/2"	22,0	45	30	32	30	WHV-S-16-G 1/2"-SC	172,85
S	400	20	G 3/4"	26,5	53	36	40	36	WHV-S-20-G 3/4"-SC	262,64
S	250	25	G 1"	31,5	66	46	50	46	WHV-S-25-G 1"-SC	414,60
S	250	30	G 1 1/4"	37,0	76	55	60	50	WHV-S-30-G 1 1/4"-SC	612,61
S	250	38	G 1 1/2"	41,5	87	60	70	60	WHV-S-38-G 1 1/2"-SC	862,07



Winkel-Schwenkverschraubungen

Mit VA-Dichtkantenring für Ausdrehung DIN 3852 (schmal)
Hohlschraube muss vor der Montage geschmiert werden
(siehe Allgemeine Informationen Rubrik 1)

Auf Anfrage: Mit gekammertem Weichdichtring -
Rubrik 8.255 und 8.256

Einschraubgewinde G: Whitworth-Rohrgewinde - Zylindrisch

Banjo Elbows

With Stainless Steel Sealing Ring for DIN 3853 (small)

Banjo Bolt must be greased prior to assembly (see General
Information Category 1)

On Request: With Bonded Seal Ring - Category 8.255 and 8.256
Thread G: BSP - Parallel

Reihe Series	Druck Pressure PN	Rohr A.D. Tube O.D. D1	Gewinde Thread G	Ca. Maße Approx. Dimensions				Bestellzeichen Order-Code OMD	Brutto-Preis Gross-Price Euro (€)
LL	100	4	G 1/8"					WHV-LL-04-G 1/8"-OMD	74,80
LL	100	6	G 1/8"					WHV-LL-06-G 1/8"-OMD	74,42
LL	100	8	G 1/8"					WHV-LL-08-G 1/8"-OMD	75,65

Reihe Series	Druck Pressure PN	Rohr A.D. Tube O.D. D1	Gewinde Thread G	Ca. Maße Approx. Dimensions				Bestellzeichen Order-Code OMD	Brutto-Preis Gross-Price Euro (€)
L	500	6	G 1/8"					WHV-L-06-G 1/8"-OMD	74,38
L	400	8	G 1/4"					WHV-L-08-G 1/4"-OMD	79,01
L	350	10	G 1/4"					WHV-L-10-G 1/4"-OMD	86,12
L	350	10	G 3/8"					WHV-L-10-G 3/8"-OMD	113,51
L	350	12	G 1/4"					WHV-L-12-G 1/4"-OMD	113,51
L	350	12	G 3/8"					WHV-L-12-G 3/8"-OMD	103,48
L	315	12	G 1/2"					WHV-L-12-G 1/2"-OMD	125,24
L	315	15	G 1/2"					WHV-L-15-G 1/2"-OMD	125,24
L	315	18	G 1/2"					WHV-L-18-G 1/2"-OMD	157,55
L	200	22	G 3/4"					WHV-L-22-G 3/4"-OMD	247,90
L	200	28	G 1"					WHV-L-28-G 1"-OMD	368,62
L	200	35	G 1 1/4"					WHV-L-35-G 1 1/4"-OMD	546,43
L	200	42	G 1 1/2"					WHV-L-42-G 1 1/2"-OMD	775,31

Reihe Series	Druck Pressure PN	Rohr A.D. Tube O.D. D1	Gewinde Thread G	Ca. Maße Approx. Dimensions				Bestellzeichen Order-Code OMD	Brutto-Preis Gross-Price Euro (€)
S	500	6	G 1/4"					WHV-S-06-G 1/4"-OMD	81,57
S	450	8	G 1/4"					WHV-S-08-G 1/4"-OMD	88,83
S	400	10	G 1/4"					WHV-S-10-G 1/4"-OMD	111,96
S	400	10	G 3/8"					WHV-S-10-G 3/8"-OMD	100,88
S	400	12	G 3/8"					WHV-S-12-G 3/8"-OMD	113,15
S	400	14	G 1/2"					WHV-S-14-G 1/2"-OMD	132,55
S	400	16	G 1/2"					WHV-S-16-G 1/2"-OMD	163,08
S	400	20	G 3/4"					WHV-S-20-G 3/4"-OMD	250,18
S	250	25	G 1"					WHV-S-25-G 1"-OMD	392,98
S	250	30	G 1 1/4"					WHV-S-30-G 1 1/4"-OMD	585,01
S	250	38	G 1 1/2"					WHV-S-38-G 1 1/2"-OMD	824,62

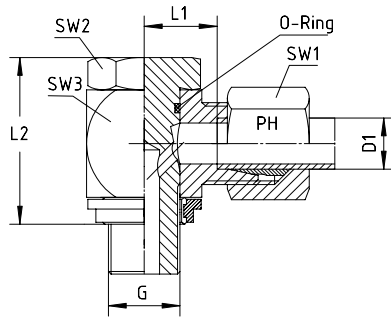

Winkel-Schwenkverschraubungen

Für Einschraubloch mit Eindrehung schmal nach ISO 1179
Hohlschraube muss vor der Montage geschmiert werden
(siehe Allgemeine Informationen Rubrik 1)
Mit gekammerter Weichdichtung - Viton - Rubrik 8.257
Einschraubgewinde G: Whitworth-Rohrgewinde - Zylindrisch

Banjo Elbows

For recesses narrow ISO 1179
Banjo Bolt must be greased prior to assembly (see General
Information Category 1)
With Bonded Seal Ring - Viton - Category 8.257
Thread G: BSP - Parallel

Reihe Series	Druck Pressure PN	Rohr A.D. Tube O.D. D1	Gewinde Thread G	Ca. Maße Approx. Dimensions					Bestellzeichen Order-Code Standard	Brutto-Preis Gross-Price Euro (€)
				L1	L2	SW1	SW2	SW3		
LL	100	4	G 1/8"	11,0	24	17	18	10	WHV-LL-04-G 1/8"-WDS	88,51
LL	100	6	G 1/8"	11,5	24	17	18	12	WHV-LL-06-G 1/8"-WDS	88,51
LL	100	8	G 1/8"	11,5	24	17	18	14	WHV-LL-08-G 1/8"-WDS	90,02

Reihe Series	Druck Pressure PN	Rohr A.D. Tube O.D. D1	Gewinde Thread G	Ca. Maße Approx. Dimensions					Bestellzeichen Order-Code Standard	Brutto-Preis Gross-Price Euro (€)
				L1	L2	SW1	SW2	SW3		
L	500	6	G 1/8"	12,0	24	17	18	14	WHV-L-06-G 1/8"-WDS	87,74
L	400	8	G 1/4"	14,5	30	19	22	17	WHV-L-08-G 1/4"-WDS	96,09
L	350	10	G 1/4"	15,5	30	19	22	19	WHV-L-10-G 1/4"-WDS	103,76
L	350	10	G 3/8"	17,5	35	24	27	19	WHV-L-10-G 3/8"-WDS	133,23
L	350	12	G 1/4"	15,5	30	19	22	22	WHV-L-12-G 1/4"-WDS	131,68
L	350	12	G 3/8"	18,0	36	24	27	22	WHV-L-12-G 3/8"-WDS	123,20
L	315	12	G 1/2"	21,5	45	30	32	22	WHV-L-12-G 1/2"-WDS	152,41
L	315	15	G 1/2"	21,5	45	30	32	27	WHV-L-15-G 1/2"-WDS	152,41
L	315	18	G 1/2"	21,0	45	30	32	32	WHV-L-18-G 1/2"-WDS	188,20
L	200	22	G 3/4"	27,5	53	36	40	36	WHV-L-22-G 3/4"-WDS	303,88
L	200	28	G 1"	32,0	66	46	50	41	WHV-L-28-G 1"-WDS	439,97
L	200	35	G 1 1/4"	36,0	76	55	60	50	WHV-L-35-G 1 1/4"-WDS	629,87
L	200	42	G 1 1/2"	40,5	87	60	70	60	WHV-L-42-G 1 1/2"-WDS	891,59

Reihe Series	Druck Pressure PN	Rohr A.D. Tube O.D. D1	Gewinde Thread G	Ca. Maße Approx. Dimensions					Bestellzeichen Order-Code Standard	Brutto-Preis Gross-Price Euro (€)
				L1	L2	SW1	SW2	SW3		
S	500	6	G 1/4"	16,5	30	19	22	17	WHV-S-06-G 1/4"-WDS	98,64
S	450	8	G 1/4"	16,5	30	19	22	19	WHV-S-08-G 1/4"-WDS	106,31
S	400	10	G 1/4"	16,5	30	19	22	22	WHV-S-10-G 1/4"-WDS	130,18
S	400	10	G 3/8"	18,5	36	24	27	22	WHV-S-10-G 3/8"-WDS	120,65
S	400	12	G 3/8"	18,5	36	24	27	24	WHV-S-12-G 3/8"-WDS	133,43
S	400	14	G 1/2"	22,5	45	30	32	27	WHV-S-14-G 1/2"-WDS	160,08
S	400	16	G 1/2"	22,0	45	30	32	30	WHV-S-16-G 1/2"-WDS	193,32
S	400	20	G 3/4"	26,5	53	36	40	36	WHV-S-20-G 3/4"-WDS	298,25
S	250	25	G 1"	31,5	66	46	50	46	WHV-S-25-G 1"-WDS	458,24
S	250	30	G 1 1/4"	37,0	76	55	60	50	WHV-S-30-G 1 1/4"-WDS	671,38
S	250	38	G 1 1/2"	41,5	87	60	70	60	WHV-S-38-G 1 1/2"-WDS	945,28

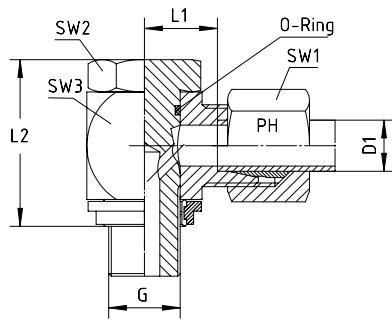

Winkel-Schwenkverschraubungen

Für Einschraubloch mit Eindrehung schmal nach ISO 1179
Hohlschraube muss vor der Montage geschmiert werden
(siehe Allgemeine Informationen Rubrik 1)
Mit gekammerter Weichdichtung - Viton - Rubrik 8.257
Einschraubgewinde G: Whitworth-Rohrgewinde - Zylindrisch

Banjo Elbows

For recesses narrow ISO 1179
Banjo Bolt must be greased prior to assembly (see General Information Category 1)
With Bonded Seal Ring - Viton - Category 8.257
Thread G: BSP - Parallel

Reihe Series	Druck Pressure PN	Rohr A.D. Tube O.D. D1	Gewinde Thread G	Ca. Maße Approx. Dimensions					Bestellzeichen Order-Code SC	Brutto-Preis Gross-Price Euro (€)
				L1	L2	SW1	SW2	SW3		
L	500	6	G 1/8"	12,0	24	17	18	14	WHV-L-06-G 1/8"-WDS-SC	88,06
L	400	8	G 1/4"	14,5	30	19	22	17	WHV-L-08-G 1/4"-WDS-SC	96,53
L	350	10	G 1/4"	15,5	30	19	22	19	WHV-L-10-G 1/4"-WDS-SC	104,02
L	350	10	G 3/8"	17,5	35	24	27	19	WHV-L-10-G 3/8"-WDS-SC	140,65
L	350	12	G 1/4"	15,5	30	19	22	22	WHV-L-12-G 1/4"-WDS-SC	132,24
L	350	12	G 3/8"	18,0	36	24	27	22	WHV-L-12-G 3/8"-WDS-SC	123,76
L	315	12	G 1/2"	21,5	45	30	32	22	WHV-L-12-G 1/2"-WDS-SC	153,49
L	315	15	G 1/2"	21,5	45	30	32	27	WHV-L-15-G 1/2"-WDS-SC	153,49
L	315	18	G 1/2"	21,0	45	30	32	32	WHV-L-18-G 1/2"-WDS-SC	189,84
L	200	22	G 3/4"	27,5	53	36	40	36	WHV-L-22-G 3/4"-WDS-SC	297,46
L	200	28	G 1"	32,0	66	46	50	41	WHV-L-28-G 1"-WDS-SC	432,11
L	200	35	G 1 1/4"	36,0	76	55	60	50	WHV-L-35-G 1 1/4"-WDS-SC	634,19
L	200	42	G 1 1/2"	40,5	87	60	70	60	WHV-L-42-G 1 1/2"-WDS-SC	895,91

Reihe Series	Druck Pressure PN	Rohr A.D. Tube O.D. D1	Gewinde Thread G	Ca. Maße Approx. Dimensions					Bestellzeichen Order-Code SC	Brutto-Preis Gross-Price Euro (€)
				L1	L2	SW1	SW2	SW3		
S	500	6	G 1/4"	16,5	30	19	22	17	WHV-S-06-G 1/4"-WDS-SC	99,08
S	450	8	G 1/4"	16,5	30	19	22	19	WHV-S-08-G 1/4"-WDS-SC	106,75
S	400	10	G 1/4"	16,5	30	19	22	22	WHV-S-10-G 1/4"-WDS-SC	130,74
S	400	10	G 3/8"	18,5	36	24	27	22	WHV-S-10-G 3/8"-WDS-SC	121,21
S	400	12	G 3/8"	18,5	36	24	27	24	WHV-S-12-G 3/8"-WDS-SC	134,27
S	400	14	G 1/2"	22,5	45	30	32	27	WHV-S-14-G 1/2"-WDS-SC	161,64
S	400	16	G 1/2"	22,0	45	30	32	30	WHV-S-16-G 1/2"-WDS-SC	194,88
S	400	20	G 3/4"	26,5	53	36	40	36	WHV-S-20-G 3/4"-WDS-SC	300,13
S	250	25	G 1"	31,5	66	46	50	46	WHV-S-25-G 1"-WDS-SC	461,24
S	250	30	G 1 1/4"	37,0	76	55	60	50	WHV-S-30-G 1 1/4"-WDS-SC	675,54
S	250	38	G 1 1/2"	41,5	87	60	70	60	WHV-S-38-G 1 1/2"-WDS-SC	950,92



Winkel-Schwenkverschraubungen

Für Einschraubloch mit Eindrehung schmal nach ISO 1179
Hohlschraube muss vor der Montage geschmiert werden
(siehe Allgemeine Informationen Rubrik 1)
Mit gekammerter Weichdichtung - Viton - Rubrik 8.257
Einschraubgewinde G: Whitworth-Rohrgewinde - Zylindrisch

Banjo Elbows

For recesses narrow ISO 1179
Banjo Bolt must be greased prior to assembly (see General
Information Category 1)
With Bonded Seal Ring - Viton - Category 8.257
Thread G: BSP - Parallel

Reihe Series	Druck Pressure PN	Rohr A.D. Tube O.D. D1	Gewinde Thread G	Ca. Maße Approx. Dimensions				Bestellzeichen Order-Code OMD	Brutto-Preis Gross-Price Euro (€)
LL	100	4	G 1/8"					WHV-LL-04-G 1/8"-WDS-OMD	85,85
LL	100	6	G 1/8"					WHV-LL-06-G 1/8"-WDS-OMD	85,47
LL	100	8	G 1/8"					WHV-LL-08-G 1/8"-WDS-OMD	86,70

Reihe Series	Druck Pressure PN	Rohr A.D. Tube O.D. D1	Gewinde Thread G	Ca. Maße Approx. Dimensions				Bestellzeichen Order-Code OMD	Brutto-Preis Gross-Price Euro (€)
L	500	6	G 1/8"					WHV-L-06-G 1/8"-WDS-OMD	85,43
L	400	8	G 1/4"					WHV-L-08-G 1/4"-WDS-OMD	93,29
L	350	10	G 1/4"					WHV-L-10-G 1/4"-WDS-OMD	100,40
L	350	12	G 3/8"					WHV-L-10-G 3/8"-WDS-OMD	129,34
L	350	12	G 1/4"					WHV-L-12-G 1/4"-WDS-OMD	127,79
L	350	12	G 3/8"					WHV-L-12-G 3/8"-WDS-OMD	119,31
L	315	12	G 1/2"					WHV-L-12-G 1/2"-WDS-OMD	147,27
L	315	15	G 1/2"					WHV-L-15-G 1/2"-WDS-OMD	147,27
L	315	18	G 1/2"					WHV-L-18-G 1/2"-WDS-OMD	179,58
L	200	22	G 3/4"					WHV-L-22-G 3/4"-WDS-OMD	285,39
L	200	28	G 1"					WHV-L-28-G 1"-WDS-OMD	415,26
L	200	35	G 1 1/4"					WHV-L-35-G 1 1/4"-WDS-OMD	609,36
L	200	42	G 1 1/2"					WHV-L-42-G 1 1/2"-WDS-OMD	864,16

Reihe Series	Druck Pressure PN	Rohr A.D. Tube O.D. D1	Gewinde Thread G	Ca. Maße Approx. Dimensions				Bestellzeichen Order-Code OMD	Brutto-Preis Gross-Price Euro (€)
S	500	6	G 1/4"					WHV-S-06-G 1/4"-WDS-OMD	95,85
S	450	8	G 1/4"					WHV-S-08-G 1/4"-WDS-OMD	103,11
S	400	10	G 1/4"					WHV-S-10-G 1/4"-WDS-OMD	126,24
S	400	10	G 3/8"					WHV-S-10-G 3/8"-WDS-OMD	116,71
S	400	12	G 3/8"					WHV-S-12-G 3/8"-WDS-OMD	128,98
S	400	14	G 1/2"					WHV-S-14-G 1/2"-WDS-OMD	154,58
S	400	16	G 1/2"					WHV-S-16-G 1/2"-WDS-OMD	185,11
S	400	20	G 3/4"					WHV-S-20-G 3/4"-WDS-OMD	287,67
S	250	25	G 1"					WHV-S-25-G 1"-WDS-OMD	439,62
S	250	30	G 1 1/4"					WHV-S-30-G 1 1/4"-WDS-OMD	647,94
S	250	38	G 1 1/2"					WHV-S-38-G 1 1/2"-WDS-OMD	913,47



Winkel-Schwenkverschraubungen
Mit VA-Dichtkantenring für Ausdrehung DIN 3852 (schmal)
Hohlschraube muss vor der Montage geschmiert werden
(siehe Allgemeine Informationen Rubrik 1)
Auf Anfrage: Mit gekammertem Weichdichtung -
Rubrik 8.255 und 8.256
Einschraubgewinde G: Metrisches Feingewinde - Zylindrisch

Banjo Elbows
With Stainless Steel Sealing Ring for DIN 3852 (small)
Banjo Bolt must be greased prior to assembly (see General
Information Category 1)
On Request: With Bonded Seal Ring - Category 8.255 and 8.256
Thread G: Metric - Parallel

Reihe Series	Druck Pressure PN	Rohr A.D. Tube O.D. D1	Gewinde Thread G	Ca. Maße Approx. Dimensions					Bestellzeichen Order-Code Standard	Brutto-Preis Gross-Price Euro (€)
				L1	L2	SW1	SW2	SW3		
LL	100	4	M 8 x 1	11,0	24,0	17	18	10	WHV-LL-04-M 8x1	80,53
LL	100	6	M 10 x 1	11,5	24,0	17	18	12	WHV-LL-06-M 10x1	80,53
LL	100	8	M 10 x 1	11,5	24,0	17	18	14	WHV-LL-08-M 10x1	80,53

Reihe Series	Druck Pressure PN	Rohr A.D. Tube O.D. D1	Gewinde Thread G	Ca. Maße Approx. Dimensions					Bestellzeichen Order-Code Standard	Brutto-Preis Gross-Price Euro (€)
				L1	L2	SW1	SW2	SW3		
L	500	6	M 10 x 1	12,0	24,0	17	18	14	WHV-L-06-M 10x1	79,25
L	400	8	M 12 x 1,5	14,5	30,0	19	22	17	WHV-L-08-M 12x1,5	84,36
L	350	10	M 14 x 1,5	15,5	30,0	19	22	19	WHV-L-10-M 14x1,5	89,48
L	315	12	M 16 x 1,5	18,0	36,0	24	27	22	WHV-L-12-M 16x1,5	102,26
L	315	15	M 18 x 1,5	20,5	39,5	27	30	27	WHV-L-15-M 18x1,5	130,38
L	315	18	M 22 x 1,5	21,0	45,0	30	32	32	WHV-L-18-M 22x1,5	163,62
L	200	22	M 26 x 1,5	27,5	53,0	36	40	36	WHV-L-22-M 26x1,5	258,21
L	200	28	M 33 x 2	32,0	66,0	46	50	41	WHV-L-28-M 33x2	393,70
L	200	35	M 42 x 2	36,0	76,0	55	60	50	WHV-L-35-M 42x2	595,66
L	200	42	M 48 x 2	40,5	87,0	60	70	60	WHV-L-42-M 48x2	851,31

Reihe Series	Druck Pressure PN	Rohr A.D. Tube O.D. D1	Gewinde Thread G	Ca. Maße Approx. Dimensions					Bestellzeichen Order-Code Standard	Brutto-Preis Gross-Price Euro (€)
				L1	L2	SW1	SW2	SW3		
S	500	6	M 12 x 1,5	16,5	30,0	19	22	17	WHV-S-06-M 12x1,5	84,36
S	450	8	M 14 x 1,5	16,5	30,0	19	22	19	WHV-S-08-M 14x1,5	92,03
S	400	10	M 16 x 1,5	18,5	36,0	24	27	22	WHV-S-10-M 16x1,5	104,82
S	400	12	M 18 x 1,5	20,0	39,5	27	30	24	WHV-S-12-M 18x1,5	120,16
S	400	14	M 20 x 1,5	22,5	43,5	30	32	27	WHV-S-14-M 20x1,5	140,61
S	400	16	M 22 x 1,5	22,0	45,0	30	32	30	WHV-S-16-M 22x1,5	178,95
S	400	20	M 27 x 2	26,5	53,0	36	40	36	WHV-S-20-M 27x2	263,32
S	250	25	M 33 x 2	31,5	66,0	46	50	46	WHV-S-25-M 33x2	378,36
S	250	30	M 42 x 2	37,0	76,0	55	60	50	WHV-S-30-M 42x2	616,12
S	250	38	M 48 x 2	41,5	87,0	60	70	60	WHV-S-38-M 48x2	892,22

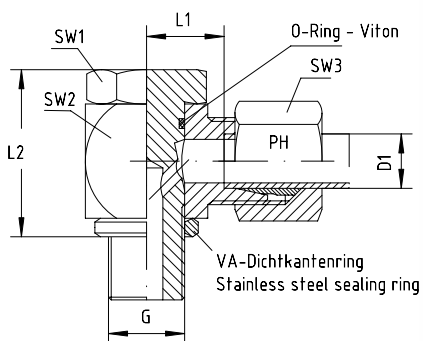

Winkel-Schwenkverschraubungen

Mit VA-Dichtkantenring für Ausdrehung DIN 3852 (schmal)
Hohlschraube muss vor der Montage geschmiert werden
(siehe Allgemeine Informationen Rubrik 1)

Auf Anfrage: Mit gekammertem Weichdichtring -
Rubrik 8.255 und 8.256

Einschraubgewinde G: Metrisches Feingewinde - Zylindrisch

Banjo Elbows

With Stainless Steel Sealing Ring for DIN 3852 (small)

Banjo Bolt must be greased prior to assembly (see General
Information Category 1)

On Request: With Bonded Seal Ring - Category 8.255 and 8.256
Thread G: Metric - Parallel

Reihe Series	Druck Pressure PN	Rohr A.D. Tube O.D. D1	Gewinde Thread G	Ca. Maße Approx. Dimensions					Bestellzeichen Order-Code SC	Brutto-Preis Gross-Price Euro (€)
				L1	L2	SW1	SW2	SW3		
L	500	6	M 10 x 1	12,0	24,0	17	18	14	WHV-L-06-M 10x1-SC	79,57
L	400	8	M 12 x 1,5	14,5	30,0	19	22	17	WHV-L-08-M 12x1,5-SC	84,80
L	350	10	M 14 x 1,5	15,5	30,0	19	22	19	WHV-L-10-M 14x1,5-SC	89,92
L	315	12	M 16 x 1,5	18,0	36,0	24	27	22	WHV-L-12-M 16x1,5-SC	102,82
L	315	15	M 18 x 1,5	20,5	39,5	27	30	27	WHV-L-15-M 18x1,5-SC	131,46
L	315	18	M 22 x 1,5	21,0	45,0	30	32	32	WHV-L-18-M 22x1,5-SC	165,26
L	200	22	M 26 x 1,5	27,5	53,0	36	40	36	WHV-L-22-M 26x1,5-SC	259,97
L	200	28	M 33 x 2	32,0	66,0	46	50	41	WHV-L-28-M 33x2-SC	395,70
L	200	35	M 42 x 2	36,0	76,0	55	60	50	WHV-L-35-M 42x2-SC	599,38
L	200	42	M 48 x 2	40,5	87,0	60	70	60	WHV-L-42-M 48x2-SC	855,63

Reihe Series	Druck Pressure PN	Rohr A.D. Tube O.D. D1	Gewinde Thread G	Ca. Maße Approx. Dimensions					Bestellzeichen Order-Code SC	Brutto-Preis Gross-Price Euro (€)
				L1	L2	SW1	SW2	SW3		
S	500	6	M 12 x 1,5	16,5	30,0	19	22	17	WHV-S-06-M 12x1,5-SC	84,80
S	450	8	M 14 x 1,5	16,5	30,0	19	22	19	WHV-S-08-M 14x1,5-SC	92,47
S	400	10	M 16 x 1,5	18,5	36,0	24	27	22	WHV-S-10-M 16x1,5-SC	105,38
S	400	12	M 18 x 1,5	20,0	39,5	27	30	24	WHV-S-12-M 18x1,5-SC	121,00
S	400	14	M 20 x 1,5	22,5	43,5	30	32	27	WHV-S-14-M 20x1,5-SC	142,17
S	400	16	M 22 x 1,5	22,0	45,0	30	32	30	WHV-S-16-M 22x1,5-SC	180,51
S	400	20	M 27 x 2	26,5	53,0	36	40	36	WHV-S-20-M 27x2-SC	265,20
S	250	25	M 33 x 2	31,5	66,0	46	50	46	WHV-S-25-M 33x2-SC	381,36
S	250	30	M 42 x 2	37,0	76,0	55	60	50	WHV-S-30-M 42x2-SC	620,28
S	250	38	M 48 x 2	41,5	87,0	60	70	60	WHV-S-38-M 48x2-SC	897,86



Winkel-Schwenkverschraubungen

Mit VA-Dichtkantenring für Ausdrehung DIN 3852 (schmal)
Hohlschraube muss vor der Montage geschmiert werden
(siehe Allgemeine Informationen Rubrik 1)

Auf Anfrage: Mit gekammertem Weichdichtung -
Rubrik 8.255 und 8.256

Einschraubgewinde G: Metrisches Feingewinde - Zylindrisch

Banjo Elbows

With Stainless Steel Sealing Ring for DIN 3852 (small)

Banjo Bolt must be greased prior to assembly (see General
Information Category 1)

On Request: With Bonded Seal Ring - Category 8.255 and 8.256
Thread G: Metric - Parallel

Reihe Series	Druck Pressure PN	Rohr A.D. Tube O.D. D1	Gewinde Thread G	Ca. Maße Approx. Dimensions				Bestellzeichen Order-Code OMD	Brutto-Preis Gross-Price Euro (€)
LL	100	4	M 8 x 1					WHV-LL-04-M 8x1-OMD	77,87
LL	100	6	M 10 x 1					WHV-LL-06-M 10x1-OMD	77,49
LL	100	8	M 10 x 1					WHV-LL-08-M 10x1-OMD	77,03

Reihe Series	Druck Pressure PN	Rohr A.D. Tube O.D. D1	Gewinde Thread G	Ca. Maße Approx. Dimensions				Bestellzeichen Order-Code OMD	Brutto-Preis Gross-Price Euro (€)
L	500	6	M 10 x 1					WHV-L-06-M 10x1-OMD	76,94
L	400	8	M 12 x 1,5					WHV-L-08-M 12x1,5-OMD	81,56
L	350	10	M 14 x 1,5					WHV-L-10-M 14x1,5-OMD	86,12
L	315	12	M 16 x 1,5					WHV-L-12-M 16x1,5-OMD	98,37
L	315	15	M 18 x 1,5					WHV-L-15-M 18x1,5-OMD	125,24
L	315	18	M 22 x 1,5					WHV-L-18-M 22x1,5-OMD	155,00
L	200	22	M 26 x 1,5					WHV-L-22-M 26x1,5-OMD	247,90
L	200	28	M 33 x 2					WHV-L-28-M 33x2-OMD	378,85
L	200	35	M 42 x 2					WHV-L-35-M 42x2-OMD	574,55
L	200	42	M 48 x 2					WHV-L-42-M 48x2-OMD	823,88

Reihe Series	Druck Pressure PN	Rohr A.D. Tube O.D. D1	Gewinde Thread G	Ca. Maße Approx. Dimensions				Bestellzeichen Order-Code OMD	Brutto-Preis Gross-Price Euro (€)
S	500	6	M 12 x 1,5					WHV-S-06-M 12x1,5-OMD	81,57
S	450	8	M 14 x 1,5					WHV-S-08-M 14x1,5-OMD	88,83
S	400	10	M 16 x 1,5					WHV-S-10-M 16x1,5-OMD	100,88
S	400	12	M 18 x 1,5					WHV-S-12-M 18x1,5-OMD	115,71
S	400	14	M 20 x 1,5					WHV-S-14-M 20x1,5-OMD	135,11
S	400	16	M 22 x 1,5					WHV-S-16-M 22x1,5-OMD	170,74
S	400	20	M 27 x 2					WHV-S-20-M 27x2-OMD	252,74
S	250	25	M 33 x 2					WHV-S-25-M 33x2-OMD	359,74
S	250	30	M 42 x 2					WHV-S-30-M 42x2-OMD	592,68
S	250	38	M 48 x 2					WHV-S-38-M 48x2-OMD	860,41

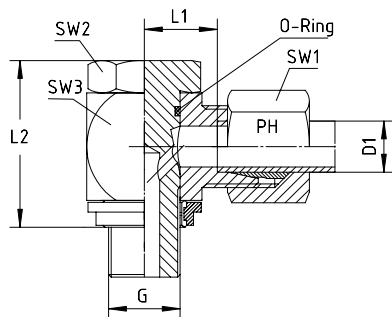

Winkel-Schwenkverschraubungen

Für Einschraubloch mit Eindrehung schmal nach ISO 9974
Hohlschraube muss vor der Montage geschmiert werden
(siehe Allgemeine Informationen Rubrik 1)
Mit gekammerter Weichdichtung - Viton - Rubrik 8.257
Einschraubgewinde G: Metrisches Feingewinde - Zylindrisch

Banjo Elbows

For recesses narrow ISO 9974
Banjo Bolt must be greased prior to assembly (see General
Information Category 1)
With Bonded Seal Ring - Viton - Category 8.257
Thread G: Metric - Parallel

Reihe Series	Druck Pressure PN	Rohr A.D. Tube O.D. D1	Gewinde Thread G	Ca. Maße Approx. Dimensions					Bestellzeichen Order-Code Standard	Brutto-Preis Gross-Price Euro (€)
				L1	L2	SW1	SW2	SW3		
LL	100	6	M 10 x 1	11,5	24,0	17	18	12	WHV-LL-06-M 10x1-WDS	91,91
LL	100	8	M 10 x 1	11,5	24,0	17	18	14	WHV-LL-08-M 10x1-WDS	91,91

Reihe Series	Druck Pressure PN	Rohr A.D. Tube O.D. D1	Gewinde Thread G	Ca. Maße Approx. Dimensions					Bestellzeichen Order-Code Standard	Brutto-Preis Gross-Price Euro (€)
				L1	L2	SW1	SW2	SW3		
L	500	6	M 10 x 1	12,0	24,0	17	18	14	WHV-L-06-M 10x1-WDS	90,63
L	400	8	M 12 x 1,5	14,5	30,0	19	22	17	WHV-L-08-M 12x1,5-WDS	114,84
L	350	10	M 14 x 1,5	15,5	30,0	19	22	19	WHV-L-10-M 14x1,5-WDS	103,40
L	315	12	M 16 x 1,5	18,0	36,0	24	27	22	WHV-L-12-M 16x1,5-WDS	118,02
L	315	15	M 18 x 1,5	20,5	39,5	27	30	27	WHV-L-15-M 18x1,5-WDS	147,08
L	315	18	M 22 x 1,5	21,0	45,0	30	32	32	WHV-L-18-M 22x1,5-WDS	185,55
L	200	22	M 26 x 1,5	27,5	53,0	36	40	36	WHV-L-22-M 26x1,5-WDS	287,66
L	200	28	M 33 x 2	32,0	66,0	46	50	41	WHV-L-28-M 33x2-WDS	440,08
L	200	35	M 42 x 2	36,0	76,0	55	60	50	WHV-L-35-M 42x2-WDS	658,53
L	200	42	M 48 x 2	40,5	87,0	60	70	60	WHV-L-42-M 48x2-WDS	940,16

Reihe Series	Druck Pressure PN	Rohr A.D. Tube O.D. D1	Gewinde Thread G	Ca. Maße Approx. Dimensions					Bestellzeichen Order-Code Standard	Brutto-Preis Gross-Price Euro (€)
				L1	L2	SW1	SW2	SW3		
S	500	6	M 12 x 1,5	16,5	30,0	19	22	17	WHV-S-06-M 12x1,5-WDS	114,84
S	450	8	M 14 x 1,5	16,5	30,0	19	22	19	WHV-S-08-M 14x1,5-WDS	105,95
S	400	10	M 16 x 1,5	18,5	36,0	24	27	22	WHV-S-10-M 16x1,5-WDS	120,58
S	400	12	M 18 x 1,5	20,0	39,5	27	30	24	WHV-S-12-M 18x1,5-WDS	136,86
S	400	16	M 22 x 1,5	22,0	45,0	30	32	30	WHV-S-16-M 22x1,5-WDS	200,88
S	400	20	M 27 x 2	26,5	53,0	36	40	36	WHV-S-20-M 27x2-WDS	300,63
S	250	25	M 33 x 2	31,5	66,0	46	50	46	WHV-S-25-M 33x2-WDS	424,74
S	250	30	M 42 x 2	37,0	76,0	55	60	50	WHV-S-30-M 42x2-WDS	678,99
S	250	38	M 48 x 2	41,5	87,0	60	70	60	WHV-S-38-M 48x2-WDS	981,07

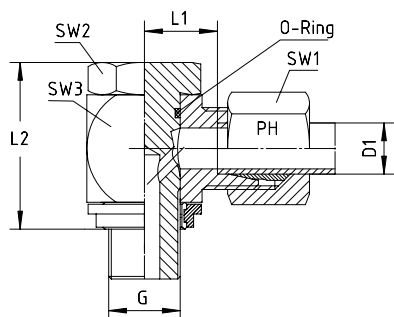

Winkel-Schwenkverschraubungen

Für Einschraubloch mit Eindrehung schmal nach ISO 9974
Hohlschraube muss vor der Montage geschmiert werden
(siehe Allgemeine Informationen Rubrik 1)
Mit gekammerter Weichdichtung - Viton - Rubrik 8.257
Einschraubgewinde G: Metrisches Feingewinde - Zylindrisch

Banjo Elbows

For recesses narrow ISO 9974
Banjo Bolt must be greased prior to assembly (see General Information Category 1)
With Bonded Seal Ring - Viton - Category 8.257
Thread G: Metric - Parallel

Reihe Series	Druck Pressure PN	Rohr A.D. Tube O.D. D1	Gewinde Thread G	Ca. Maße Approx. Dimensions					Bestellzeichen Order-Code SC	Brutto-Preis Gross-Price Euro (€)
				L1	L2	SW1	SW2	SW3		
L	500	6	M 10 x 1	12,0	24,0	17	18	14	WHV-L-06-M 10x1-WDS-SC	90,95
L	400	8	M 12 x 1,5	14,5	30,0	19	22	17	WHV-L-08-M 12x1,5-WDS-SC	115,28
L	350	10	M 14 x 1,5	15,5	30,0	19	22	19	WHV-L-10-M 14x1,5-WDS-SC	103,84
L	315	12	M 16 x 1,5	18,0	36,0	24	27	22	WHV-L-12-M 16x1,5-WDS-SC	118,58
L	315	15	M 18 x 1,5	20,5	39,5	27	30	27	WHV-L-15-M 18x1,5-WDS-SC	148,16
L	315	18	M 22 x 1,5	21,0	45,0	30	32	32	WHV-L-18-M 22x1,5-WDS-SC	187,19
L	200	22	M 26 x 1,5	27,5	53,0	36	40	36	WHV-L-22-M 26x1,5-WDS-SC	289,42
L	200	28	M 33 x 2	32,0	66,0	46	50	41	WHV-L-28-M 33x2-WDS-SC	442,08
L	200	35	M 42 x 2	36,0	76,0	55	60	50	WHV-L-35-M 42x2-WDS-SC	662,25
L	200	42	M 48 x 2	40,5	87,0	60	70	60	WHV-L-42-M 48x2-WDS-SC	944,48

Reihe Series	Druck Pressure PN	Rohr A.D. Tube O.D. D1	Gewinde Thread G	Ca. Maße Approx. Dimensions					Bestellzeichen Order-Code SC	Brutto-Preis Gross-Price Euro (€)
				L1	L2	SW1	SW2	SW3		
S	500	6	M 12 x 1,5	16,5	30,0	19	22	17	WHV-S-06-M 12x1,5-WDS-SC	115,28
S	450	8	M 14 x 1,5	16,5	30,0	19	22	19	WHV-S-08-M 14x1,5-WDS-SC	106,39
S	400	10	M 16 x 1,5	18,5	36,0	24	27	22	WHV-S-10-M 16x1,5-WDS-SC	121,14
S	400	12	M 18 x 1,5	20,0	39,5	27	30	24	WHV-S-12-M 18x1,5-WDS-SC	137,70
S	400	16	M 22 x 1,5	22,0	45,0	30	32	30	WHV-S-16-M 22x1,5-WDS-SC	202,44
S	400	20	M 27 x 2	26,5	53,0	36	40	36	WHV-S-20-M 27x2-WDS-SC	302,51
S	250	25	M 33 x 2	31,5	66,0	46	50	46	WHV-S-25-M 33x2-WDS-SC	427,74
S	250	30	M 42 x 2	37,0	76,0	55	60	50	WHV-S-30-M 42x2-WDS-SC	683,15
S	250	38	M 48 x 2	41,5	87,0	60	70	60	WHV-S-38-M 48x2-WDS-SC	986,71



Winkel-Schwenkverschraubungen

Für Einschraubloch mit Eindrehung schmal nach ISO 9974
Hohlschraube muss vor der Montage geschmiert werden
(siehe Allgemeine Informationen Rubrik 1)
Mit gekammerter Weichdichtung - Viton - Rubrik 8.257
Einschraubgewinde G: Metrisches Feingewinde - Zylindrisch

Banjo Elbows

For recesses narrow ISO 9974
Banjo Bolt must be greased prior to assembly (see General Information Category 1)
With Bonded Seal Ring - Viton - Category 8.257
Thread G: Metric - Parallel

Reihe Series	Druck Pressure PN	Rohr A.D. Tube O.D. D1	Gewinde Thread G	Ca. Maße Approx. Dimensions				Bestellzeichen Order-Code OMD	Brutto-Preis Gross-Price Euro (€)
LL	100	6	M 10 x 1					WHV-LL-06-M 10x1-WDS-OMD	88,87
LL	100	8	M 10 x 1					WHV-LL-08-M 10x1-WDS-OMD	88,41

Reihe Series	Druck Pressure PN	Rohr A.D. Tube O.D. D1	Gewinde Thread G	Ca. Maße Approx. Dimensions				Bestellzeichen Order-Code OMD	Brutto-Preis Gross-Price Euro (€)
L	500	6	M 10 x 1					WHV-L-06-M 10x1-WDS-OMD	88,32
L	400	8	M 12 x 1,5					WHV-L-08-M 12x1,5-WDS-OMD	112,04
L	350	10	M 14 x 1,5					WHV-L-10-M 14x1,5-WDS-OMD	100,04
L	315	12	M 16 x 1,5					WHV-L-12-M 16x1,5-WDS-OMD	114,13
L	315	15	M 18 x 1,5					WHV-L-15-M 18x1,5-WDS-OMD	141,94
L	315	18	M 22 x 1,5					WHV-L-18-M 22x1,5-WDS-OMD	176,93
L	200	22	M 26 x 1,5					WHV-L-22-M 26x1,5-WDS-OMD	269,73
L	200	28	M 33 x 2					WHV-L-28-M 33x2-WDS-OMD	425,23
L	200	35	M 42 x 2					WHV-L-35-M 42x2-WDS-OMD	637,42
L	200	42	M 48 x 2					WHV-L-42-M 48x2-WDS-OMD	912,73

Reihe Series	Druck Pressure PN	Rohr A.D. Tube O.D. D1	Gewinde Thread G	Ca. Maße Approx. Dimensions				Bestellzeichen Order-Code OMD	Brutto-Preis Gross-Price Euro (€)
S	500	6	M 12 x 1,5					WHV-S-06-M 12x1,5-WDS-OMD	112,05
S	450	8	M 14 x 1,5					WHV-S-08-M 14x1,5-WDS-OMD	103,11
S	400	10	M 16 x 1,5					WHV-S-10-M 16x1,5-WDS-OMD	116,64
S	400	12	M 18 x 1,5					WHV-S-12-M 18x1,5-WDS-OMD	132,41
S	400	16	M 22 x 1,5					WHV-S-16-M 22x1,5-WDS-OMD	192,67
S	400	20	M 27 x 2					WHV-S-20-M 27x2-WDS-OMD	290,05
S	250	25	M 33 x 2					WHV-S-25-M 33x2-WDS-OMD	406,12
S	250	30	M 42 x 2					WHV-S-30-M 42x2-WDS-OMD	655,55
S	250	38	M 48 x 2					WHV-S-38-M 48x2-WDS-OMD	949,26

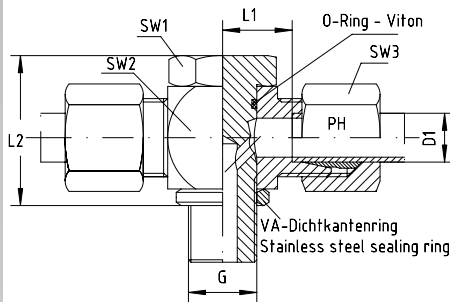

T-Schwenkverschraubungen

Mit VA-Dichtkantenring für Ausdehnung DIN 3852 (schmal)
Hohlschraube muss vor der Montage geschmiert werden
(siehe Allgemeine Informationen Rubrik 1)

Auf Anfrage: Mit gekamertem Weichdichtung -
Rubrik 8.255 und 8.256

Einschraubgewinde G: Whitworth-Rohrgewinde - Zylindrisch

Banjo Tees

With Stainless Steel Sealing Ring for DIN 3852 (small)

Banjo Bolt must be greased prior to assembly (see General
Information Category 1)

On Request: With Bonded Seal Ring - Category 8.255 and 8.256
Thread G: BSP - Parallel

Reihe Series	Druck Pressure PN	Rohr A.D. Tube O.D. D1	Gewinde Thread G	Ca. Maße Approx. Dimensions					Bestellzeichen Order-Code Standard	Brutto-Preis Gross-Price Euro (€)
				L1	L2	SW1	SW2	SW3		
LL	100	4	G 1/8"	11,0	24	17	18	10	THV-LL-04-R 1/8"	130,38
LL	100	6	G 1/8"	11,5	24	17	18	12	THV-LL-06-R 1/8"	130,38
LL	100	8	G 1/8"	11,5	24	17	18	14	THV-LL-08-R 1/8"	130,38

Reihe Series	Druck Pressure PN	Rohr A.D. Tube O.D. D1	Gewinde Thread G	Ca. Maße Approx. Dimensions					Bestellzeichen Order-Code Standard	Brutto-Preis Gross-Price Euro (€)
				L1	L2	SW1	SW2	SW3		
L	500	6	G 1/8"	12,0	24	17	18	14	THV-L-06-R 1/8"	130,38
L	400	8	G 1/4"	14,5	30	19	22	17	THV-L-08-R 1/4"	143,16
L	350	10	G 1/4"	15,5	30	19	22	19	THV-L-10-R 1/4"	166,17
L	350	12	G 1/4"	15,5	30	19	22	22	THV-L-12-R 1/4"	199,90
L	350	12	G 3/8"	18,0	36	24	27	22	THV-L-12-R 3/8"	184,07
L	315	15	G 1/2"	21,5	45	30	32	27	THV-L-15-R 1/2"	253,09
L	315	18	G 1/2"	21,0	45	30	32	32	THV-L-18-R 1/2"	314,45
L	200	22	G 3/4"	27,5	53	36	40	36	THV-L-22-R 3/4"	495,96
L	200	28	G 1"	32,0	66	46	50	41	THV-L-28-R 1"	715,82
L	200	35	G 1 1/4"	36,0	76	55	60	50	THV-L-35-R 1 1/4"	961,24
L	200	42	G 1 1/2"	40,5	87	60	70	60	THV-L-42-R 1 1/2"	1191,33

Reihe Series	Druck Pressure PN	Rohr A.D. Tube O.D. D1	Gewinde Thread G	Ca. Maße Approx. Dimensions					Bestellzeichen Order-Code Standard	Brutto-Preis Gross-Price Euro (€)
				L1	L2	SW1	SW2	SW3		
S	500	6	G 1/4"	16,5	30	19	22	17	THV-S-06-R 1/4"	143,16
S	450	8	G 1/4"	16,5	30	19	22	19	THV-S-08-R 1/4"	161,06
S	400	10	G 1/4"	16,5	30	19	22	22	THV-S-10-R 1/4"	199,50
S	400	10	G 3/8"	18,5	36	24	27	22	THV-S-10-R 3/8"	189,18
S	400	12	G 3/8"	18,5	36	24	27	24	THV-S-12-R 3/8"	201,96
S	400	14	G 1/2"	22,5	45	30	32	27	THV-S-14-R 1/2"	260,76
S	400	16	G 1/2"	22,0	45	30	32	30	THV-S-16-R 1/2"	329,79
S	400	20	G 3/4"	26,5	53	36	40	36	THV-S-20-R 3/4"	490,85
S	250	25	G 1"	31,5	66	46	50	46	THV-S-25-R 1"	664,69
S	250	30	G 1 1/4"	37,0	76	55	60	50	THV-S-30-R 1 1/4"	887,11
S	250	38	G 1 1/2"	41,5	87	60	70	60	THV-S-38-R 1 1/2"	1119,75

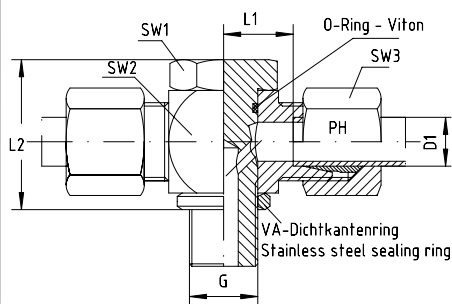

T-Schwenkverschraubungen

Mit VA-Dichtkantenring für Ausdrehung DIN 3852 (schmal)
Hohlschraube muss vor der Montage geschmiert werden
(siehe Allgemeine Informationen Rubrik 1)

Auf Anfrage: Mit gekammertem Weichdichtring -
Rubrik 8.255 und 8.256

Einschraubgewinde G: Whitworth-Rohrgewinde - Zylindrisch

Banjo Tees

With Stainless Steel Sealing Ring for DIN 3852 (small)

Banjo Bolt must be greased prior to assembly (see General
Information Category 1)

On Request: With Bonded Seal Ring - Category 8.255 and 8.256
Thread G: BSP - Parallel

Reihe Series	Druck Pressure PN	Rohr A.D. Tube O.D. D1	Gewinde Thread G	Ca. Maße Approx. Dimensions					Bestellzeichen Order-Code SC	Brutto-Preis Gross-Price Euro (€)
				L1	L2	SW1	SW2	SW3		
L	500	6	G 1/8"	12,0	24	17	18	14	THV-L-06-R 1/8"-SC	131,02
L	400	8	G 1/4"	14,5	30	19	22	17	THV-L-08-R 1/4"-SC	144,04
L	350	10	G 1/4"	15,5	30	19	22	19	THV-L-10-R 1/4"-SC	167,05
L	350	12	G 1/4"	15,5	30	19	22	22	THV-L-12-R 1/4"-SC	201,02
L	350	12	G 3/8"	18,0	36	24	27	22	THV-L-12-R 3/8"-SC	185,19
L	315	15	G 1/2"	21,5	45	30	32	27	THV-L-15-R 1/2"-SC	255,25
L	315	18	G 1/2"	21,0	45	30	32	32	THV-L-18-R 1/2"-SC	317,73
L	200	22	G 3/4"	27,5	53	36	40	36	THV-L-22-R 3/4"-SC	499,48
L	200	28	G 1"	32,0	66	46	50	41	THV-L-28-R 1"-SC	719,82
L	200	35	G 1 1/4"	36,0	76	55	60	50	THV-L-35-R 1 1/4"-SC	968,68
L	200	42	G 1 1/2"	40,5	87	60	70	60	THV-L-42-R 1 1/2"-SC	1199,97

Reihe Series	Druck Pressure PN	Rohr A.D. Tube O.D. D1	Gewinde Thread G	Ca. Maße Approx. Dimensions					Bestellzeichen Order-Code SC	Brutto-Preis Gross-Price Euro (€)
				L1	L2	SW1	SW2	SW3		
S	500	6	G 1/4"	16,5	30	19	22	17	THV-S-06-R 1/4"-SC	144,04
S	450	8	G 1/4"	16,5	30	19	22	19	THV-S-08-R 1/4"-SC	161,94
S	400	10	G 1/4"	16,5	30	19	22	22	THV-S-10-R 1/4"-SC	200,62
S	400	10	G 3/8"	18,5	36	24	27	22	THV-S-10-R 3/8"-SC	190,30
S	400	12	G 3/8"	18,5	36	24	27	24	THV-S-12-R 3/8"-SC	203,64
S	400	14	G 1/2"	22,5	45	30	32	27	THV-S-14-R 1/2"-SC	263,88
S	400	16	G 1/2"	22,0	45	30	32	30	THV-S-16-R 1/2"-SC	332,91
S	400	20	G 3/4"	26,5	53	36	40	36	THV-S-20-R 3/4"-SC	494,61
S	250	25	G 1"	31,5	66	46	50	46	THV-S-25-R 1"-SC	670,69
S	250	30	G 1 1/4"	37,0	76	55	60	50	THV-S-30-R 1 1/4"-SC	895,43
S	250	38	G 1 1/2"	41,5	87	60	70	60	THV-S-38-R 1 1/2"-SC	1131,03



T-Schwenkverschraubungen

Mit VA-Dichtkantenring für Ausdrehung DIN 3852 (schmal)
Hohlschraube muss vor der Montage geschmiert werden
(siehe Allgemeine Informationen Rubrik 1)

Auf Anfrage: Mit gekammertem Weichdichtring -
Rubrik 8.255 und 8.256

Einschraubgewinde G: Whitworth-Rohrgewinde - Zylindrisch

Banjo Tees

With Stainless Steel Sealing Ring for DIN 3852 (small)

Banjo Bolt must be greased prior to assembly (see General
Information Category 1)

On Request: With Bonded Seal Ring - Category 8.255 and 8.256
Thread G: BSP - Parallel

Reihe Series	Druck Pressure PN	Rohr A.D. Tube O.D. D1	Gewinde Thread G	Ca. Maße Approx. Dimensions				Bestellzeichen Order-Code OMD	Brutto-Preis Gross-Price Euro (€)
LL	100	4	G 1/8"					THV-LL-04-R 1/8"-OMD	125,06
LL	100	6	G 1/8"					THV-LL-06-R 1/8"-OMD	124,30
LL	100	8	G 1/8"					THV-LL-08-R 1/8"-OMD	123,38

Reihe Series	Druck Pressure PN	Rohr A.D. Tube O.D. D1	Gewinde Thread G	Ca. Maße Approx. Dimensions				Bestellzeichen Order-Code OMD	Brutto-Preis Gross-Price Euro (€)
L	500	6	G 1/8"					THV-L-06-R 1/8"-OMD	125,76
L	400	8	G 1/4"					THV-L-08-R 1/4"-OMD	137,56
L	350	10	G 1/4"					THV-L-10-R 1/4"-OMD	159,45
L	350	12	G 1/4"					THV-L-12-R 1/4"-OMD	192,12
L	350	12	G 3/8"					THV-L-12-R 3/8"-OMD	176,29
L	315	15	G 1/2"					THV-L-15-R 1/2"-OMD	242,81
L	315	18	G 1/2"					THV-L-18-R 1/2"-OMD	297,21
L	200	22	G 3/4"					THV-L-22-R 3/4"-OMD	475,34
L	200	28	G 1"					THV-L-28-R 1"-OMD	686,12
L	200	35	G 1 1/4"					THV-L-35-R 1 1/4"-OMD	919,02
L	200	42	G 1 1/2"					THV-L-42-R 1 1/2"-OMD	1136,47

Reihe Series	Druck Pressure PN	Rohr A.D. Tube O.D. D1	Gewinde Thread G	Ca. Maße Approx. Dimensions				Bestellzeichen Order-Code OMD	Brutto-Preis Gross-Price Euro (€)
S	500	6	G 1/4"					THV-S-06-R 1/4"-OMD	137,58
S	450	8	G 1/4"					THV-S-08-R 1/4"-OMD	154,66
S	400	10	G 1/4"					THV-S-10-R 1/4"-OMD	191,62
S	400	10	G 3/8"					THV-S-10-R 3/8"-OMD	181,30
S	400	12	G 3/8"					THV-S-12-R 3/8"-OMD	193,06
S	400	14	G 1/2"					THV-S-14-R 1/2"-OMD	249,76
S	400	16	G 1/2"					THV-S-16-R 1/2"-OMD	313,37
S	400	20	G 3/4"					THV-S-20-R 3/4"-OMD	469,69
S	250	25	G 1"					THV-S-25-R 1"-OMD	627,45
S	250	30	G 1 1/4"					THV-S-30-R 1 1/4"-OMD	840,23
S	250	38	G 1 1/2"					THV-S-38-R 1 1/2"-OMD	1056,47

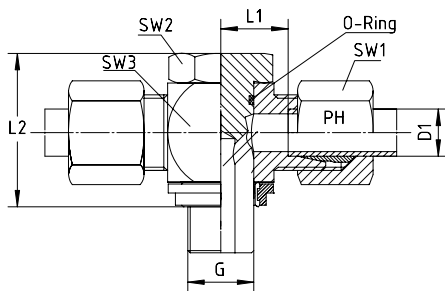

T-Schwenkverschraubungen

Für Einschraubloch mit Eindrehung schmal nach ISO 1179
Hohlschraube muss vor der Montage geschmiert werden
(siehe Allgemeine Informationen Rubrik 1)
Mit gekammerter Weichdichtung - Viton - Rubrik 8.257
Einschraubgewinde G: Whitworth-Rohrgewinde - Zylindrisch

Banjo Tees

For recesses narrow ISO 1179
Banjo Bolt must be greased prior to assembly (see General
Information Category 1)
With Bonded Seal Ring - Viton - Category 8.257
Thread G: BSP - Parallel

Reihe Series	Druck Pressure PN	Rohr A.D. Tube O.D. D1	Gewinde Thread G	Ca. Maße Approx. Dimensions					Bestellzeichen Order-Code Standard	Brutto-Preis Gross-Price Euro (€)
				L1	L2	SW1	SW2	SW3		
LL	100	4	G 1/8"	11,0	24	17	18	10	THV-LL-04-R 1/8"-WDS	141,43
LL	100	6	G 1/8"	11,5	24	17	18	12	THV-LL-06-R 1/8"-WDS	141,43
LL	100	8	G 1/8"	11,5	24	17	18	14	THV-LL-08-R 1/8"-WDS	141,43

Reihe Series	Druck Pressure PN	Rohr A.D. Tube O.D. D1	Gewinde Thread G	Ca. Maße Approx. Dimensions					Bestellzeichen Order-Code Standard	Brutto-Preis Gross-Price Euro (€)
				L1	L2	SW1	SW2	SW3		
L	500	6	G 1/8"	12,0	24	17	18	14	THV-L-06-R 1/8"-WDS	141,43
L	400	8	G 1/4"	14,5	30	19	22	17	THV-L-08-R 1/4"-WDS	157,44
L	350	10	G 1/4"	15,5	30	19	22	19	THV-L-10-R 1/4"-WDS	180,45
L	350	12	G 1/4"	15,5	30	19	22	22	THV-L-12-R 1/4"-WDS	214,18
L	350	12	G 3/8"	18,0	36	24	27	22	THV-L-12-R 3/8"-WDS	199,90
L	315	15	G 1/2"	21,5	45	30	32	27	THV-L-15-R 1/2"-WDS	275,12
L	315	18	G 1/2"	21,0	45	30	32	32	THV-L-18-R 1/2"-WDS	336,48
L	200	22	G 3/4"	27,5	53	36	40	36	THV-L-22-R 3/4"-WDS	533,45
L	200	28	G 1"	32,0	66	46	50	41	THV-L-28-R 1"-WDS	762,46
L	200	35	G 1 1/4"	36,0	76	55	60	50	THV-L-35-R 1 1/4"-WDS	1024,17
L	200	42	G 1 1/2"	40,5	87	60	70	60	THV-L-42-R 1 1/2"-WDS	1280,18

Reihe Series	Druck Pressure PN	Rohr A.D. Tube O.D. D1	Gewinde Thread G	Ca. Maße Approx. Dimensions					Bestellzeichen Order-Code Standard	Brutto-Preis Gross-Price Euro (€)
				L1	L2	SW1	SW2	SW3		
S	500	6	G 1/4"	16,5	30	19	22	17	THV-S-06-R 1/4"-WDS	157,44
S	450	8	G 1/4"	16,5	30	19	22	19	THV-S-08-R 1/4"-WDS	175,34
S	400	10	G 1/4"	16,5	30	19	22	22	THV-S-10-R 1/4"-WDS	213,78
S	400	10	G 3/8"	18,5	36	24	27	22	THV-S-10-R 3/8"-WDS	205,01
S	400	12	G 3/8"	18,5	36	24	27	24	THV-S-12-R 3/8"-WDS	217,79
S	400	14	G 1/2"	22,5	45	30	32	27	THV-S-14-R 1/2"-WDS	282,79
S	400	16	G 1/2"	22,0	45	30	32	30	THV-S-16-R 1/2"-WDS	351,82
S	400	20	G 3/4"	26,5	53	36	40	36	THV-S-20-R 3/4"-WDS	528,34
S	250	25	G 1"	31,5	66	46	50	46	THV-S-25-R 1"-WDS	711,33
S	250	30	G 1 1/4"	37,0	76	55	60	50	THV-S-30-R 1 1/4"-WDS	950,04
S	250	38	G 1 1/2"	41,5	87	60	70	60	THV-S-38-R 1 1/2"-WDS	1208,60



T-Schwenkverschraubungen

Für Einschraubloch mit Eindrehung schmal nach ISO 1179
Hohlschraube muss vor der Montage geschmiert werden
(siehe Allgemeine Informationen Rubrik 1)
Mit gekammerter Weichdichtung - Viton - Rubrik 8.257
Einschraubgewinde G: Whitworth-Rohrgewinde - Zylindrisch

Banjo Tees

For recesses narrow ISO 1179
Banjo Bolt must be greased prior to assembly (see General Information Category 1)
With Bonded Seal Ring - Viton - Category 8.257
Thread G: BSP - Parallel

Reihe Series	Druck Pressure PN	Rohr A.D. Tube O.D. D1	Gewinde Thread G	Ca. Maße Approx. Dimensions					Bestellzeichen Order-Code SC	Brutto-Preis Gross-Price Euro (€)
				L1	L2	SW1	SW2	SW3		
L	500	6	G 1/8"	12,0	24	17	18	14	THV-L-06-R 1/8"-WDS-SC	142,07
L	400	8	G 1/4"	14,5	30	19	22	17	THV-L-08-R 1/4"-WDS-SC	158,32
L	350	10	G 1/4"	15,5	30	19	22	19	THV-L-10-R 1/4"-WDS-SC	181,33
L	350	12	G 1/4"	15,5	30	19	22	22	THV-L-12-R 1/4"-WDS-SC	215,30
L	350	12	G 3/8"	18,0	36	24	27	22	THV-L-12-R 3/8"-WDS-SC	201,02
L	315	15	G 1/2"	21,5	45	30	32	27	THV-L-15-R 1/2"-WDS-SC	277,28
L	315	18	G 1/2"	21,0	45	30	32	32	THV-L-18-R 1/2"-WDS-SC	339,76
L	200	22	G 3/4"	27,5	53	36	40	36	THV-L-22-R 3/4"-WDS-SC	536,97
L	200	28	G 1"	32,0	66	46	50	41	THV-L-28-R 1"-WDS-SC	766,46
L	200	35	G 1 1/4"	36,0	76	55	60	50	THV-L-35-R 1 1/4"-WDS-SC	1031,61
L	200	42	G 1 1/2"	40,5	87	60	70	60	THV-L-42-R 1 1/2"-WDS-SC	1288,82

Reihe Series	Druck Pressure PN	Rohr A.D. Tube O.D. D1	Gewinde Thread G	Ca. Maße Approx. Dimensions					Bestellzeichen Order-Code SC	Brutto-Preis Gross-Price Euro (€)
				L1	L2	SW1	SW2	SW3		
S	500	6	G 1/4"	16,5	30	19	22	17	THV-S-06-R 1/4"-WDS-SC	158,32
S	450	8	G 1/4"	16,5	30	19	22	19	THV-S-08-R 1/4"-WDS-SC	176,22
S	400	10	G 1/4"	16,5	30	19	22	22	THV-S-10-R 1/4"-WDS-SC	214,90
S	400	10	G 3/8"	18,5	36	24	27	22	THV-S-10-R 3/8"-WDS-SC	206,13
S	400	12	G 3/8"	18,5	36	24	27	24	THV-S-12-R 3/8"-WDS-SC	219,47
S	400	14	G 1/2"	22,5	45	30	32	27	THV-S-14-R 1/2"-WDS-SC	285,91
S	400	16	G 1/2"	22,0	45	30	32	30	THV-S-16-R 1/2"-WDS-SC	354,94
S	400	20	G 3/4"	26,5	53	36	40	36	THV-S-20-R 3/4"-WDS-SC	532,10
S	250	25	G 1"	31,5	66	46	50	46	THV-S-25-R 1"-WDS-SC	717,33
S	250	30	G 1 1/4"	37,0	76	55	60	50	THV-S-30-R 1 1/4"-WDS-SC	958,36
S	250	38	G 1 1/2"	41,5	87	60	70	60	THV-S-38-R 1 1/2"-WDS-SC	1219,88



T-Schwenkverschraubungen

Für Einschraubloch mit Eindrehung schmal nach ISO 1179
Hohlschraube muss vor der Montage geschmiert werden
(siehe Allgemeine Informationen Rubrik 1)
Mit gekammerter Weichdichtung - Viton - Rubrik 8.257
Einschraubgewinde G: Whitworth-Rohrgewinde - Zylindrisch

Banjo Tees

For recesses narrow ISO 1179
Banjo Bolt must be greased prior to assembly (see General
Information Category 1)
With Bonded Seal Ring - Viton - Category 8.257
Thread G: BSP - Parallel

Reihe Series	Druck Pressure PN	Rohr A.D. Tube O.D. D1	Gewinde Thread G	Ca. Maße Approx. Dimensions					Bestellzeichen Order-Code OMD	Brutto-Preis Gross-Price Euro (€)
LL	100	4	G 1/8"						THV-LL-04-R 1/8"-WDS-OMD	136,11
LL	100	6	G 1/8"						THV-LL-06-R 1/8"-WDS-OMD	135,35
LL	100	8	G 1/8"						THV-LL-08-R 1/8"-WDS-OMD	134,43

Reihe Series	Druck Pressure PN	Rohr A.D. Tube O.D. D1	Gewinde Thread G	Ca. Maße Approx. Dimensions					Bestellzeichen Order-Code OMD	Brutto-Preis Gross-Price Euro (€)
L	500	6	G 1/8"						THV-L-06-R 1/8"-WDS-OMD	136,81
L	400	8	G 1/4"						THV-L-08-R 1/4"-WDS-OMD	151,84
L	350	10	G 1/4"						THV-L-10-R 1/4"-WDS-OMD	173,73
L	350	12	G 1/4"						THV-L-12-R 1/4"-WDS-OMD	206,04
L	350	12	G 3/8"						THV-L-12-R 3/8"-WDS-OMD	192,12
L	315	15	G 1/2"						THV-L-15-R 1/2"-WDS-OMD	264,84
L	315	18	G 1/2"						THV-L-18-R 1/2"-WDS-OMD	319,24
L	200	22	G 3/4"						THV-L-22-R 3/4"-WDS-OMD	512,83
L	200	28	G 1"						THV-L-28-R 1"-WDS-OMD	732,76
L	200	35	G 1 1/4"						THV-L-35-R 1 1/4"-WDS-OMD	981,95
L	200	42	G 1 1/2"						THV-L-42-R 1 1/2"-WDS-OMD	1225,32

Reihe Series	Druck Pressure PN	Rohr A.D. Tube O.D. D1	Gewinde Thread G	Ca. Maße Approx. Dimensions					Bestellzeichen Order-Code OMD	Brutto-Preis Gross-Price Euro (€)
S	500	6	G 1/4"						THV-S-06-R 1/4"-WDS-OMD	151,86
S	450	8	G 1/4"						THV-S-08-R 1/4"-WDS-OMD	168,94
S	400	10	G 1/4"						THV-S-10-R 1/4"-WDS-OMD	205,90
S	400	10	G 3/8"						THV-S-10-R 3/8"-WDS-OMD	197,13
S	400	12	G 3/8"						THV-S-12-R 3/8"-WDS-OMD	208,89
S	400	14	G 1/2"						THV-S-14-R 1/2"-WDS-OMD	271,79
S	400	16	G 1/2"						THV-S-16-R 1/2"-WDS-OMD	335,40
S	400	20	G 3/4"						THV-S-20-R 3/4"-WDS-OMD	507,18
S	250	25	G 1"						THV-S-25-R 1"-WDS-OMD	674,09
S	250	30	G 1 1/4"						THV-S-30-R 1 1/4"-WDS-OMD	903,16
S	250	38	G 1 1/2"						THV-S-38-R 1 1/2"-WDS-OMD	1145,32

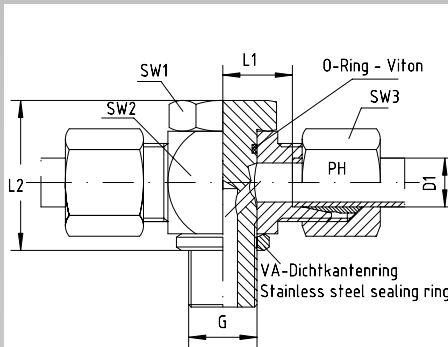

T-Schwenverschraubungen

Mit VA-Dichtkantenring für Ausdrehung DIN 3852 (schmal)
Hohlschraube muss vor der Montage geschmiert werden
(siehe Allgemeine Informationen Rubrik 1)

Auf Anfrage: Mit gekammertem Weichdichtring -
Rubrik 8.255 und 8.256

Einschraubgewinde G: Metrisches Feingewinde - Zylindrisch

Banjo Tees

With Stainless Steel Sealing Ring for DIN 3852 (small)

Banjo Bolt must be greased prior to assembly (see General
Information Category 1)

On Request: With Bonded Seal Ring - Category 8.255 and 8.256
Thread G: Metric - Parallel

Reihe Series	Druck Pressure PN	Rohr A.D. Tube O.D. D1	Gewinde Thread G	Ca. Maße Approx. Dimensions					Bestellzeichen Order-Code Standard	Brutto-Preis Gross-Price Euro (€)
				L1	L2	SW1	SW2	SW3		
LL	100	4	M 8 x 1	11,0	24,0	17	18	10	THV-LL-04-M 8x1	136,93
LL	100	6	M 10 x 1	11,5	24,0	17	18	12	THV-LL-06-M 10x1	136,93
LL	100	8	M 10 x 1	11,5	24,0	17	18	14	THV-LL-08-M 10x1	136,93

Reihe Series	Druck Pressure PN	Rohr A.D. Tube O.D. D1	Gewinde Thread G	Ca. Maße Approx. Dimensions					Bestellzeichen Order-Code Standard	Brutto-Preis Gross-Price Euro (€)
				L1	L2	SW1	SW2	SW3		
L	500	6	M 10 x 1	12,0	24,0	17	18	14	THV-L-06-M 10x1	135,49
L	400	8	M 12 x 1,5	14,5	30,0	19	22	17	THV-L-08-M 12x1,5	150,83
L	350	10	M 14 x 1,5	15,5	30,0	19	22	19	THV-L-10-M 14x1,5	176,40
L	350	12	M 16 x 1,5	18,0	36,0	24	27	22	THV-L-12-M 16x1,5	194,29
L	315	15	M 18 x 1,5	20,5	39,5	27	30	27	THV-L-15-M 18x1,5	265,88
L	315	18	M 22 x 1,5	21,0	45,0	30	32	32	THV-L-18-M 22x1,5	332,34
L	200	22	M 26 x 1,5	27,5	53,0	36	40	36	THV-L-22-M 26x1,5	518,97
L	200	28	M 33 x 2	32,0	66,0	46	50	41	THV-L-28-M 33x2	749,05
L	200	35	M 42 x 2	36,0	76,0	55	60	50	THV-L-35-M 42x2	1007,26
L	200	42	M 48 x 2	40,5	87,0	60	70	60	THV-L-42-M 48x2	1247,57

Reihe Series	Druck Pressure PN	Rohr A.D. Tube O.D. D1	Gewinde Thread G	Ca. Maße Approx. Dimensions					Bestellzeichen Order-Code Standard	Brutto-Preis Gross-Price Euro (€)
				L1	L2	SW1	SW2	SW3		
S	500	6	M 12 x 1,5	16,5	30,0	19	22	17	THV-S-06-M 12x1,5	150,83
S	450	8	M 14 x 1,5	16,5	30,0	19	22	19	THV-S-08-M 14x1,5	168,73
S	400	10	M 16 x 1,5	18,5	36,0	24	27	22	THV-S-10-M 16x1,5	199,41
S	400	12	M 18 x 1,5	20,0	39,5	27	30	24	THV-S-12-M 18x1,5	212,19
S	400	14	M 20 x 1,5	22,5	43,5	30	32	27	THV-S-14-M 20x1,5	276,10
S	400	16	M 22 x 1,5	22,0	45,0	30	32	30	THV-S-16-M 22x1,5	347,68
S	400	20	M 27 x 2	26,5	53,0	36	40	36	THV-S-20-M 27x2	513,86
S	250	25	M 33 x 2	31,5	66,0	46	50	46	THV-S-25-M 33x2	697,92
S	250	30	M 42 x 2	37,0	76,0	55	60	50	THV-S-30-M 42x2	930,57
S	250	38	M 48 x 2	41,5	87,0	60	70	60	THV-S-38-M 48x2	1119,75

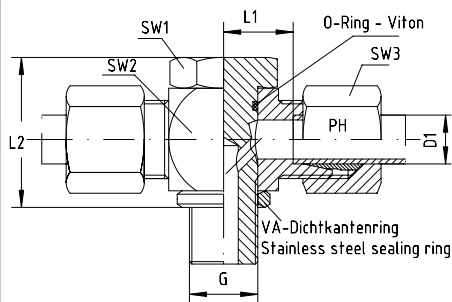

T-Schwenkverschraubungen

Mit VA-Dichtkantenring für Ausdrehung DIN 3852 (schmal)
Hohlschraube muss vor der Montage geschmiert werden
(siehe Allgemeine Informationen Rubrik 1)

Auf Anfrage: Mit gekammertem Weichdichtring -
Rubrik 8.255 und 8.256

Einschraubgewinde G: Metrisches Feingewinde - Zylindrisch

Banjo Tees

With Stainless Steel Sealing Ring for DIN 3852 (small)

Banjo Bolt must be greased prior to assembly (see General
Information Category 1)

On Request: With Bonded Seal Ring - Category 8.255 and 8.256
Thread G: Metric - Parallel

Reihe Series	Druck Pressure PN	Rohr A.D. Tube O.D. D1	Gewinde Thread G	Ca. Maße Approx. Dimensions					Bestellzeichen Order-Code SC	Brutto-Preis Gross-Price Euro (€)
				L1	L2	SW1	SW2	SW3		
L	500	6	M 10 x 1	12,0	24,0	17	18	14	THV-L-06-M 10x1-SC	136,13
L	400	8	M 12 x 1,5	14,5	30,0	19	22	17	THV-L-08-M 12x1,5-SC	151,71
L	350	10	M 14 x 1,5	15,5	30,0	19	22	19	THV-L-10-M 14x1,5-SC	177,28
L	350	12	M 16 x 1,5	18,0	36,0	24	27	22	THV-L-12-M 16x1,5-SC	195,41
L	315	15	M 18 x 1,5	20,5	39,5	27	30	27	THV-L-15-M 18x1,5-SC	268,04
L	315	18	M 22 x 1,5	21,0	45,0	30	32	32	THV-L-18-M 22x1,5-SC	335,62
L	200	22	M 26 x 1,5	27,5	53,0	36	40	36	THV-L-22-M 26x1,5-SC	522,49
L	200	28	M 33 x 2	32,0	66,0	46	50	41	THV-L-28-M 33x2-SC	753,05
L	200	35	M 42 x 2	36,0	76,0	55	60	50	THV-L-35-M 42x2-SC	1014,70
L	200	42	M 48 x 2	40,5	87,0	60	70	60	THV-L-42-M 48x2-SC	1256,21

Reihe Series	Druck Pressure PN	Rohr A.D. Tube O.D. D1	Gewinde Thread G	Ca. Maße Approx. Dimensions					Bestellzeichen Order-Code SC	Brutto-Preis Gross-Price Euro (€)
				L1	L2	SW1	SW2	SW3		
S	500	6	M 12 x 1,5	16,5	30,0	19	22	17	THV-S-06-M 12x1,5-SC	151,71
S	450	8	M 14 x 1,5	16,5	30,0	19	22	19	THV-S-08-M 14x1,5-SC	169,61
S	400	10	M 16 x 1,5	18,5	36,0	24	27	22	THV-S-10-M 16x1,5-SC	200,53
S	400	12	M 18 x 1,5	20,0	39,5	27	30	24	THV-S-12-M 18x1,5-SC	213,87
S	400	14	M 20 x 1,5	22,5	43,5	30	32	27	THV-S-14-M 20x1,5-SC	279,22
S	400	16	M 22 x 1,5	22,0	45,0	30	32	30	THV-S-16-M 22x1,5-SC	350,80
S	400	20	M 27 x 2	26,5	53,0	36	40	36	THV-S-20-M 27x2-SC	517,62
S	250	25	M 33 x 2	31,5	66,0	46	50	46	THV-S-25-M 33x2-SC	703,92
S	250	30	M 42 x 2	37,0	76,0	55	60	50	THV-S-30-M 42x2-SC	938,89
S	250	38	M 48 x 2	41,5	87,0	60	70	60	THV-S-38-M 48x2-SC	1131,03



T-Schwenkverschraubungen

Mit VA-Dichtkantenring für Ausdrehung DIN 3852 (schmal)
Hohlschraube muss vor der Montage geschmiert werden
(siehe Allgemeine Informationen Rubrik 1)

Auf Anfrage: Mit gekammertem Weichdichtring -
Rubrik 8.255 und 8.256

Einschraubgewinde G: Metrisches Feingewinde - Zylindrisch

Banjo Tees

With Stainless Steel Sealing Ring for DIN 3852 (small)

Banjo Bolt must be greased prior to assembly (see General
Information Category 1)

On Request: With Bonded Seal Ring - Category 8.255 and 8.256
Thread G: Metric - Parallel

Reihe Series	Druck Pressure PN	Rohr A.D. Tube O.D. D1	Gewinde Thread G	Ca. Maße Approx. Dimensions				Bestellzeichen Order-Code OMD	Brutto-Preis Gross-Price Euro (€)
LL	100	4	M 8 x 1					THV-LL-04-M 8x1-OMD	131,61
LL	100	6	M 10 x 1					THV-LL-06-M 10x1-OMD	130,85
LL	100	8	M 10 x 1					THV-LL-08-M 10x1-OMD	129,93

Reihe Series	Druck Pressure PN	Rohr A.D. Tube O.D. D1	Gewinde Thread G	Ca. Maße Approx. Dimensions				Bestellzeichen Order-Code OMD	Brutto-Preis Gross-Price Euro (€)
L	500	6	M 10 x 1					THV-L-06-M 10x1-OMD	130,87
L	400	8	M 12 x 1,5					THV-L-08-M 12x1,5-OMD	145,23
L	350	10	M 14 x 1,5					THV-L-10-M 14x1,5-OMD	169,68
L	350	12	M 16 x 1,5					THV-L-12-M 16x1,5-OMD	186,51
L	315	15	M 18 x 1,5					THV-L-15-M 18x1,5-OMD	255,60
L	315	18	M 22 x 1,5					THV-L-18-M 22x1,5-OMD	315,10
L	200	22	M 26 x 1,5					THV-L-22-M 26x1,5-OMD	498,35
L	200	28	M 33 x 2					THV-L-28-M 33x2-OMD	719,35
L	200	35	M 42 x 2					THV-L-35-M 42x2-OMD	965,04
L	200	42	M 48 x 2					THV-L-42-M 48x2-OMD	1192,71

Reihe Series	Druck Pressure PN	Rohr A.D. Tube O.D. D1	Gewinde Thread G	Ca. Maße Approx. Dimensions				Bestellzeichen Order-Code OMD	Brutto-Preis Gross-Price Euro (€)
S	500	6	M 12 x 1,5					THV-S-06-M 12x1,5-OMD	145,25
S	450	8	M 14 x 1,5					THV-S-08-M 14x1,5-OMD	162,33
S	400	10	M 16 x 1,5					THV-S-10-M 16x1,5-OMD	191,53
S	400	12	M 18 x 1,5					THV-S-12-M 18x1,5-OMD	203,29
S	400	14	M 20 x 1,5					THV-S-14-M 20x1,5-OMD	265,10
S	400	16	M 22 x 1,5					THV-S-16-M 22x1,5-OMD	331,26
S	400	20	M 27 x 2					THV-S-20-M 27x2-OMD	492,70
S	250	25	M 33 x 2					THV-S-25-M 33x2-OMD	660,68
S	250	30	M 42 x 2					THV-S-30-M 42x2-OMD	883,69
S	250	38	M 48 x 2					THV-S-38-M 48x2-OMD	1056,47

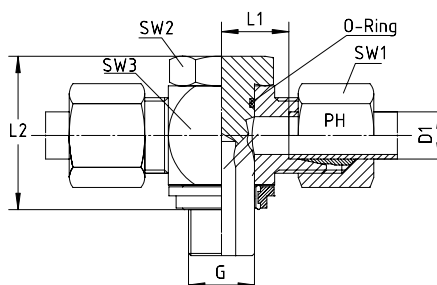

T-Schwenkverschraubungen

Für Einschraubloch mit Eindrehung schmal nach ISO 9974
Hohlschraube muss vor der Montage geschmiert werden
(siehe Allgemeine Informationen Rubrik 1)
Mit gekammerter Weichdichtung - Viton - Rubrik 8.257
Einschraubgewinde G: Metrisches Feingewinde - Zylindrisch

Banjo Tees

For recesses narrow ISO 9974
Banjo Bolt must be greased prior to assembly (see General Information Category 1)
With bonded Seal Ring - Viton - Category 8.257
Thread G: Metric - Parallel

Reihe Series	Druck Pressure PN	Rohr A.D. Tube O.D. D1	Gewinde Thread G	Ca. Maße Approx. Dimensions					Bestellzeichen Order-Code Standard	Brutto-Preis Gross-Price Euro (€)
				L1	L2	SW1	SW2	SW3		
LL	100	6	M 10 x 1	11,5	24,0	17	18	12	THV-LL-06-M 10x1-WDS	148,31
LL	100	8	M 10 x 1	11,5	24,0	17	18	14	THV-LL-08-M 10x1-WDS	148,31

Reihe Series	Druck Pressure PN	Rohr A.D. Tube O.D. D1	Gewinde Thread G	Ca. Maße Approx. Dimensions					Bestellzeichen Order-Code Standard	Brutto-Preis Gross-Price Euro (€)
				L1	L2	SW1	SW2	SW3		
L	500	6	M 10 x 1	12,0	24,0	17	18	14	THV-L-06-M 10x1-WDS	146,87
L	400	8	M 12 x 1,5	14,5	30,0	19	22	17	THV-L-08-M 12x1,5-WDS	181,31
L	350	10	M 14 x 1,5	15,5	30,0	19	22	19	THV-L-10-M 14x1,5-WDS	190,32
L	350	12	M 16 x 1,5	18,0	36,0	24	27	22	THV-L-12-M 16x1,5-WDS	210,05
L	315	15	M 18 x 1,5	20,5	39,5	27	30	27	THV-L-15-M 18x1,5-WDS	282,58
L	315	18	M 22 x 1,5	21,0	45,0	30	32	32	THV-L-18-M 22x1,5-WDS	354,27
L	200	22	M 26 x 1,5	27,5	53,0	36	40	36	THV-L-22-M 26x1,5-WDS	548,42
L	200	28	M 33 x 2	32,0	66,0	46	50	41	THV-L-28-M 33x2-WDS	795,43
L	200	35	M 42 x 2	36,0	76,0	55	60	50	THV-L-35-M 42x2-WDS	1070,13
L	200	42	M 48 x 2	40,5	87,0	60	70	60	THV-L-42-M 48x2-WDS	1336,42

Reihe Series	Druck Pressure PN	Rohr A.D. Tube O.D. D1	Gewinde Thread G	Ca. Maße Approx. Dimensions					Bestellzeichen Order-Code Standard	Brutto-Preis Gross-Price Euro (€)
				L1	L2	SW1	SW2	SW3		
S	500	6	M 12 x 1,5	16,5	30,0	19	22	17	THV-S-06-M 12x1,5-WDS	181,31
S	450	8	M 14 x 1,5	16,5	30,0	19	22	19	THV-S-08-M 14x1,5-WDS	182,65
S	400	10	M 16 x 1,5	18,5	36,0	24	27	22	THV-S-10-M 16x1,5-WDS	215,17
S	400	12	M 18 x 1,5	20,0	39,5	27	30	24	THV-S-12-M 18x1,5-WDS	228,89
S	400	16	M 22 x 1,5	22,0	45,0	30	32	30	THV-S-16-M 22x1,5-WDS	369,61
S	400	20	M 27 x 2	26,5	53,0	36	40	36	THV-S-20-M 27x2-WDS	551,17
S	250	25	M 33 x 2	31,5	66,0	46	50	46	THV-S-25-M 33x2-WDS	744,30
S	250	30	M 42 x 2	37,0	76,0	55	60	50	THV-S-30-M 42x2-WDS	993,44
S	250	38	M 48 x 2	41,5	87,0	60	70	60	THV-S-38-M 48x2-WDS	1223,68

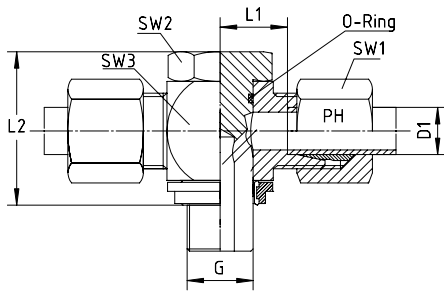

T-Schwenverschraubungen

Für Einschraubloch mit Eindrehung schmal nach ISO 9974
Hohlschraube muss vor der Montage geschmiert werden
(siehe Allgemeine Informationen Rubrik 1)
Mit gekammerter Weichdichtung - Viton - Rubrik 8.257
Einschraubgewinde G: Metrisches Feingewinde - Zylindrisch

Banjo Tees

For recesses narrow ISO 9974
Banjo Bolt must be greased prior to assembly (see General
Information Category 1)
With bonded Seal Ring - Viton - Category 8.257
Thread G: Metric - Parallel

Reihe Series	Druck Pressure PN	Rohr A.D. Tube O.D. D1	Gewinde Thread G	Ca. Maße Approx. Dimensions					Bestellzeichen Order-Code SC	Brutto-Preis Gross-Price Euro (€)
				L1	L2	SW1	SW2	SW3		
L	500	6	M 10 x 1	12,0	24,0	17	18	14	THV-L-06-M 10x1-WDS-SC	147,51
L	400	8	M 12 x 1,5	14,5	30,0	19	22	17	THV-L-08-M 12x1,5-WDS-SC	182,19
L	350	10	M 14 x 1,5	15,5	30,0	19	22	19	THV-L-10-M 14x1,5-WDS-SC	191,20
L	350	12	M 16 x 1,5	18,0	36,0	24	27	22	THV-L-12-M 16x1,5-WDS-SC	211,17
L	315	15	M 18 x 1,5	20,5	39,5	27	30	27	THV-L-15-M 18x1,5-WDS-SC	284,74
L	315	18	M 22 x 1,5	21,0	45,0	30	32	32	THV-L-18-M 22x1,5-WDS-SC	357,53
L	200	22	M 26 x 1,5	27,5	53,0	36	40	36	THV-L-22-M 26x1,5-WDS-SC	552,07
L	200	28	M 33 x 2	32,0	66,0	46	50	41	THV-L-28-M 33x2-WDS-SC	799,43
L	200	35	M 42 x 2	36,0	76,0	55	60	50	THV-L-35-M 42x2-WDS-SC	1077,57
L	200	42	M 48 x 2	40,5	87,0	60	70	60	THV-L-42-M 48x2-WDS-SC	1345,06

Reihe Series	Druck Pressure PN	Rohr A.D. Tube O.D. D1	Gewinde Thread G	Ca. Maße Approx. Dimensions					Bestellzeichen Order-Code SC	Brutto-Preis Gross-Price Euro (€)
				L1	L2	SW1	SW2	SW3		
S	500	6	M 12 x 1,5	16,5	30,0	19	22	17	THV-S-06-M 12x1,5-WDS-SC	182,19
S	450	8	M 14 x 1,5	16,5	30,0	19	22	19	THV-S-08-M 14x1,5-WDS-SC	183,53
S	400	10	M 16 x 1,5	18,5	36,0	24	27	22	THV-S-10-M 16x1,5-WDS-SC	216,29
S	400	12	M 18 x 1,5	20,0	39,5	27	30	24	THV-S-12-M 18x1,5-WDS-SC	230,57
S	400	16	M 22 x 1,5	22,0	45,0	30	32	30	THV-S-16-M 22x1,5-WDS-SC	301,15
S	400	20	M 27 x 2	26,5	53,0	36	40	36	THV-S-20-M 27x2-WDS-SC	554,93
S	250	25	M 33 x 2	31,5	66,0	46	50	46	THV-S-25-M 33x2-WDS-SC	750,30
S	250	30	M 42 x 2	37,0	76,0	55	60	50	THV-S-30-M 42x2-WDS-SC	1001,76
S	250	38	M 48 x 2	41,5	87,0	60	70	60	THV-S-38-M 48x2-WDS-SC	1219,88



T-Schwenkverschraubungen

Für Einschraubloch mit Eindrehung schmal nach ISO 9974
Hohlschraube muss vor der Montage geschmiert werden
(siehe Allgemeine Informationen Rubrik 1)
Mit gekammerter Weichdichtung - Viton - Rubrik 8.257
Einschraubgewinde G: Metrisches Feingewinde - Zylindrisch

Banjo Tees

For recesses narrow ISO 9974
Banjo Bolt must be greased prior to assembly (see General
Information Category 1)
With bonded Seal Ring - Viton - Category 8.257
Thread G: Metric - Parallel

Reihe Series	Druck Pressure PN	Rohr A.D. Tube O.D. D1	Gewinde Thread G	Ca. Maße Approx. Dimensions				Bestellzeichen Order-Code OMD	Brutto-Preis Gross-Price Euro (€)
LL	100	6	M 10 x 1					THV-LL-06-M 10x1-WDS-OMD	142,99
LL	100	8	M 10 x 1					THV-LL-08-M 10x1-WDS-OMD	141,31

Reihe Series	Druck Pressure PN	Rohr A.D. Tube O.D. D1	Gewinde Thread G	Ca. Maße Approx. Dimensions				Bestellzeichen Order-Code OMD	Brutto-Preis Gross-Price Euro (€)
L	500	6	M 10 x 1					THV-L-06-M 10x1-WDS-OMD	142,25
L	400	8	M 12 x 1,5					THV-L-08-M 12x1,5-WDS-OMD	175,71
L	350	10	M 14 x 1,5					THV-L-10-M 14x1,5-WDS-OMD	183,60
L	350	12	M 16 x 1,5					THV-L-12-M 16x1,5-WDS-OMD	202,27
L	315	15	M 18 x 1,5					THV-L-15-M 18x1,5-WDS-OMD	272,30
L	315	18	M 22 x 1,5					THV-L-18-M 22x1,5-WDS-OMD	337,03
L	200	22	M 26 x 1,5					THV-L-22-M 26x1,5-WDS-OMD	527,80
L	200	28	M 33 x 2					THV-L-28-M 33x2-WDS-OMD	765,73
L	200	35	M 42 x 2					THV-L-35-M 42x2-WDS-OMD	1027,91
L	200	42	M 48 x 2					THV-L-42-M 48x2-WDS-OMD	1281,55

Reihe Series	Druck Pressure PN	Rohr A.D. Tube O.D. D1	Gewinde Thread G	Ca. Maße Approx. Dimensions				Bestellzeichen Order-Code OMD	Brutto-Preis Gross-Price Euro (€)
S	500	6	M 12 x 1,5					THV-S-06-M 12x1,5-WDS-OMD	175,73
S	450	8	M 14 x 1,5					THV-S-08-M 14x1,5-WDS-OMD	176,25
S	400	10	M 16 x 1,5					THV-S-10-M 16x1,5-WDS-OMD	207,29
S	400	12	M 18 x 1,5					THV-S-12-M 18x1,5-WDS-OMD	219,99
S	400	16	M 22 x 1,5					THV-S-16-M 22x1,5-WDS-OMD	353,19
S	400	20	M 27 x 2					THV-S-20-M 27x2-WDS-OMD	530,01
S	250	25	M 33 x 2					THV-S-25-M 33x2-WDS-OMD	707,06
S	250	30	M 42 x 2					THV-S-30-M 42x2-WDS-OMD	946,56
S	250	38	M 48 x 2					THV-S-38-M 48x2-WDS-OMD	1145,32

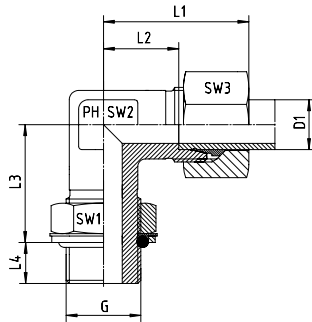

Einstellbare Winkelverschraubungen mit Kontermutter
Für Einschraublöcher mit schmaler und breiter Ausdehnung
Abdichtung durch O-Ring (Viton) und Kammerring (ISO 1179)

*Adjustable Elbow Couplings with Locknut
For Port with small and large countersink
Sealing by O-Ring (Viton) with Retaining Ring (ISO 1179)*

Reihe Series	Druck Pressure PN	Rohr A.D. Tube O.D. D1	Gewinde Thread G = BSP	Ca. Maße Approx. Dimensions								Bestellzeichen Order-Code Standard	Brutto-Preis Gross-Price Euro (€)
				L1	L2	L3	L4	SW1	SW2	SW3	D1		
L	315	6	G 1/8"	29	14	19	7	14	14	14	6	WEEV-LR-06-G 1/8"	81,72
L	315	8	G 1/4"	31	16	23	9	19	14	17	8	WEEV-LR-08-G 1/4"	81,43
L	315	10	G 1/4"	32	17	25	9	19	19	19	10	WEEV-LR-10-G 1/4"	82,56
L	250	12	G 3/8"	34	19	28	9	22	19	22	12	WEEV-LR-12-G 3/8"	93,05
L	250	15	G 1/2"	36	21	30	13	27	19	27	15	WEEV-LR-15-G 1/2"	97,43
L	250	18	G 1/2"	40	24	36	13	27	27	32	18	WEEV-LR-18-G 1/2"	142,79
L	160	22	G 3/4"	44	28	36	13	36	27	36	22	WEEV-LR-22-G 3/4"	174,14
L	160	28	G 1"	47	31	44	15	41	36	41	28	WEEV-LR-28-G 1"	274,69
L	160	35	G 1 1/4"	59	38	50	15	50	50	50	35	WEEV-LR-35-G 1 1/4"	357,41
L	160	42	G 1 1/2"	61	38	52	15	55	50	60	42	WEEV-LR-42-G 1 1/2"	519,93

Reihe Series	Druck Pressure PN	Rohr A.D. Tube O.D. D1	Gewinde Thread G = BSP	Ca. Maße Approx. Dimensions								Bestellzeichen Order-Code Standard	Brutto-Preis Gross-Price Euro (€)
				L1	L2	L3	L4	SW1	SW2	SW3	D1		
S	315	6	G 1/4"	30	15	23	9	19	14	17	6	WEEV-SR-06-G 1/4"	81,12
S	315	8	G 1/4"	32	17	27	9	19	19	19	8	WEEV-SR-08-G 1/4"	84,73
S	250	10	G 3/8"	34	18	29	9	22	19	22	10	WEEV-SR-10-G 3/8"	90,47
S	250	12	G 3/8"	38	22	29	9	22	22	24	12	WEEV-SR-12-G 3/8"	91,50
S	250	16	G 1/2"	43	25	36	13	27	27	30	16	WEEV-SR-16-G 1/2"	143,61
S	250	20	G 3/4"	49	28	39	12	36	30	36	20	WEEV-SR-20-G 3/4"	186,93
S	250	25	G 1"	54	30	44	14	41	36	46	25	WEEV-SR-25-G 1"	298,20
S	160	30	G 1 1/4"	52	36	49	15	50	50	50	30	WEEV-SR-30-G 1 1/4"	415,36
S	160	38	G 1 1/2"	65	34	55	15	55	50	60	38	WEEV-SR-38-G 1 1/2"	*

WEEV - EINSTELLBARE WINKEL- VERSCHRAUBUNGEN

WEEV - ADJUSTABLE ELBOW COUPLINGS



EDELSTAHL / STAINLESS STEEL
VERBINDUNGSTECHNIK
FLUID CONNECTORS

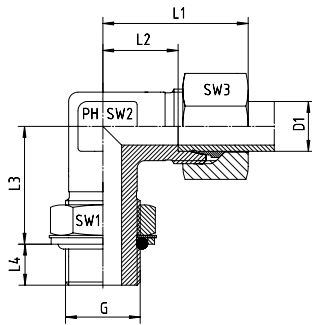

Einstellbare Winkelverschraubungen mit Kontermutter
Für Einschraublöcher mit schmaler und breiter Ausdehnung
Abdichtung durch O-Ring (Viton) und Kammerring (ISO 1179)

*Adjustable Elbow Couplings with Locknut
For Port with small and large countersink
Sealing by O-Ring (Viton) with Retaining Ring (ISO 1179)*

Reihe Series	Druck Pressure PN	Rohr A.D. Tube O.D. D1	Gewinde Thread G = BSP	Ca. Maße Approx. Dimensions								Bestellzeichen Order-Code SC	Brutto-Preis Gross-Price Euro (€)
				L1	L2	L3	L4	SW1	SW2	SW3	D1		
L	315	6	G 1/8"	29	14	19	7	14	14	14	6	WEEV-LR-06-G 1/8"-SC	82,14
L	315	8	G 1/4"	31	16	23	9	19	14	17	8	WEEV-LR-08-G 1/4"-SC	82,00
L	315	10	G 1/4"	32	17	25	9	19	19	19	10	WEEV-LR-10-G 1/4"-SC	83,14
L	250	12	G 3/8"	34	19	28	9	22	19	22	12	WEEV-LR-12-G 3/8"-SC	93,78
L	250	15	G 1/2"	36	21	30	13	27	19	27	15	WEEV-LR-15-G 1/2"-SC	98,75
L	250	18	G 1/2"	40	24	36	13	27	27	32	18	WEEV-LR-18-G 1/2"-SC	144,87
L	160	22	G 3/4"	44	28	36	13	36	27	36	22	WEEV-LR-22-G 3/4"-SC	176,42
L	160	28	G 1"	47	31	44	15	41	36	41	28	WEEV-LR-28-G 1"-SC	277,40
L	160	35	G 1 1/4"	59	38	50	15	50	50	50	35	WEEV-LR-35-G 1 1/4"-SC	362,18
L	160	42	G 1 1/2"	61	38	52	15	55	50	60	42	WEEV-LR-42-G 1 1/2"-SC	525,65

Reihe Series	Druck Pressure PN	Rohr A.D. Tube O.D. D1	Gewinde Thread G = BSP	Ca. Maße Approx. Dimensions								Bestellzeichen Order-Code SC	Brutto-Preis Gross-Price Euro (€)
				L1	L2	L3	L4	SW1	SW2	SW3	D1		
S	315	6	G 1/4"	30	15	23	9	19	14	17	6	WEEV-SR-06-G 1/4"-SC	81,69
S	315	8	G 1/4"	32	17	27	9	19	19	19	8	WEEV-SR-08-G 1/4"-SC	85,32
S	250	10	G 3/8"	34	18	29	9	22	19	22	10	WEEV-SR-10-G 3/8"-SC	91,21
S	250	12	G 3/8"	38	22	29	9	22	22	24	12	WEEV-SR-12-G 3/8"-SC	92,55
S	250	16	G 1/2"	43	25	36	13	27	27	30	16	WEEV-SR-16-G 1/2"-SC	145,59
S	250	20	G 3/4"	49	28	39	12	36	30	36	20	WEEV-SR-20-G 3/4"-SC	189,35
S	250	25	G 1"	54	30	44	14	41	36	46	25	WEEV-SR-25-G 1"-SC	302,16
S	160	30	G 1 1/4"	52	36	49	15	50	50	50	30	WEEV-SR-30-G 1 1/4"-SC	420,72
S	160	38	G 1 1/2"	65	34	55	15	55	50	60	38	WEEV-SR-38-G 1 1/2"-SC	*



Einstellbare Winkelverschraubungen mit Kontermutter
Für Einschraublöcher mit schmaler und breiter Ausdehnung
Abdichtung durch O-Ring (Viton) und Kammerring (ISO 1179)

*Adjustable Elbow Couplings with Locknut
For Port with small and large countersink
Sealing by O-Ring (Viton) with Retaining Ring (ISO 1179)*

Reihe Series	Druck Pressure PN	Rohr A.D. Tube O.D. D1	Gewinde Thread G = BSP	Ca. Maße Approx. Dimensions						Bestellzeichen Order-Code OMD	Brutto-Preis Gross-Price Euro (€)
L	315	6	G 1/8"							WEEV-LR-06-G 1/8"-OMD	79,41
L	315	8	G 1/4"							WEEV-LR-08-G 1/4"-OMD	78,63
L	315	10	G 1/4"							WEEV-LR-10-G 1/4"-OMD	79,20
L	250	12	G 3/8"							WEEV-LR-12-G 3/8"-OMD	89,16
L	250	15	G 1/2"							WEEV-LR-15-G 1/2"-OMD	92,29
L	250	18	G 1/2"							WEEV-LR-18-G 1/2"-OMD	134,17
L	160	22	G 3/4"							WEEV-LR-22-G 3/4"-OMD	163,83
L	160	28	G 1"							WEEV-LR-28-G 1"-OMD	259,84
L	160	35	G 1 1/4"							WEEV-LR-35-G 1 1/4"-OMD	336,30
L	160	42	G 1 1/2"							WEEV-LR-42-G 1 1/2"-OMD	492,50

Reihe Series	Druck Pressure PN	Rohr A.D. Tube O.D. D1	Gewinde Thread G = BSP	Ca. Maße Approx. Dimensions						Bestellzeichen Order-Code OMD	Brutto-Preis Gross-Price Euro (€)
S	315	6	G 1/4"							WEEV-SR-06-G 1/4"-OMD	78,33
S	315	8	G 1/4"							WEEV-SR-08-G 1/4"-OMD	81,53
S	250	10	G 3/8"							WEEV-SR-10-G 3/8"-OMD	86,53
S	250	12	G 3/8"							WEEV-SR-12-G 3/8"-OMD	87,05
S	250	16	G 1/2"							WEEV-SR-16-G 1/2"-OMD	135,40
S	250	20	G 3/4"							WEEV-SR-20-G 3/4"-OMD	176,35
S	250	25	G 1"							WEEV-SR-25-G 1"-OMD	279,58
S	160	30	G 1 1/4"							WEEV-SR-30-G 1 1/4"-OMD	391,92
S	160	38	G 1 1/2"							WEEV-SR-38-G 1 1/2"-OMD	*

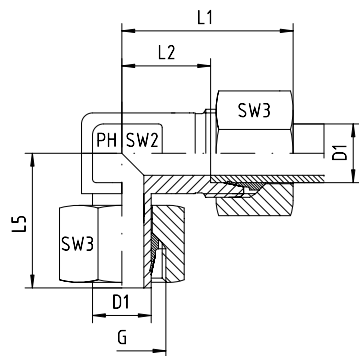

Einstellbare Winkel-Verschraubungen

Einsteckausführung - Vormontiert
Anschluss D1 ist vormontiert. Die Fertigmontage erfolgt im
Stutzen mit ca. 1/2 Umdrehung der Überwurfmutter über
den Punkt des deutlich spürbaren Kraftanstieges.

Swivel Elbows

Male Stud Type - Pre-Assembled
Port D1 is pre-assembled. Final assembly in appropriate
body with approx. 1/2 turn beyond the point of clearly
perceptible resistance.

Reihe Series	Druck Pressure PN	Rohr A.D. Tube O.D. D1	Gewinde Thread G	Ca. Maße Approx. Dimensions					Bestellzeichen Order-Code Standard	Brutto-Preis Gross-Price Euro (€)
				L1	L2	L5	SW2	SW3		
L	315	6	M 12 x 1,5	27	12,0	26,0	12	14	EVW-L-06	18,74
L	315	8	M 14 x 1,5	29	14,0	27,5	12	17	EVW-L-08	19,40
L	315	10	M 16 x 1,5	30	15,0	29,0	14	19	EVW-L-10	25,56
L	315	12	M 18 x 1,5	32	17,0	29,5	17	22	EVW-L-12	29,81
L	315	15	M 22 x 1,5	36	21,0	32,5	19	27	EVW-L-15	38,42
L	315	18	M 26 x 1,5	40	23,5	35,5	24	32	EVW-L-18	55,32
L	160	22	M 30 x 2	44	27,5	38,5	27	36	EVW-L-22	66,47
L	160	28	M 36 x 2	47	30,5	43,5	36	41	EVW-L-28	94,59
L	160	35	M 45 x 2	56	34,5	54,0	41	50	EVW-L-35	140,61
L	160	42	M 52 x 2	63	40,0	56,0	50	60	EVW-L-42	201,96

Reihe Series	Druck Pressure PN	Rohr A.D. Tube O.D. D1	Gewinde Thread G	Ca. Maße Approx. Dimensions					Bestellzeichen Order-Code Standard	Brutto-Preis Gross-Price Euro (€)
				L1	L2	L5	SW2	SW3		
S	630	6	M 14 x 1,5	31	16,0	27,0	12	17	EVW-S-06	21,73
S	630	8	M 16 x 1,5	32	17,0	27,5	14	19	EVW-S-08	25,33
S	630	10	M 18 x 1,5	34	17,5	30,0	17	22	EVW-S-10	29,55
S	630	12	M 20 x 1,5	38	21,5	31,0	17	24	EVW-S-12	34,72
S	630	14	M 22 x 1,5	40	22,0	35,0	19	27	EVW-S-14	41,44
S	400	16	M 24 x 1,5	43	24,5	36,5	24	30	EVW-S-16	54,71
S	400	20	M 30 x 2	48	26,5	44,5	27	36	EVW-S-20	68,08
S	400	25	M 36 x 2	54	30,0	50,0	36	46	EVW-S-25	99,70
S	400	30	M 42 x 2	62	35,5	55,0	41	50	EVW-S-30	143,16
S	250	38	M 52 x 2	72	41,0	63,0	50	60	EVW-S-38	207,08

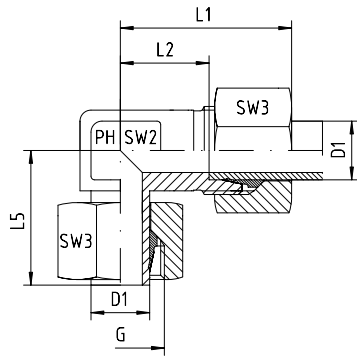

Einstellbare Winkel-Verschraubungen

Einsteckausführung - Vormontiert
Anschluss D1 ist vormontiert. Die Fertigmontage erfolgt im
Stutzen mit ca. 1/2 Umdrehung der Überwurfmutter über
den Punkt des deutlich spürbaren Kraftanstieges.

Swivel Elbows

Male Stud Type - Pre-Assembled
Port D1 is pre-assembled. Final assembly in appropriate
body with approx. 1/2 turn beyond the point of clearly
perceptible resistance.

Reihe Series	Druck Pressure PN	Rohr A.D. Tube O.D. D1	Gewinde Thread G	Ca. Maße Approx. Dimensions					Bestellzeichen Order-Code SC	Brutto-Preis Gross-Price Euro (€)
				L1	L2	L5	SW2	SW3		
L	315	6	M 12 x 1,5	27	12,0	26,0	12	14	EVW-L-06-SC	19,38
L	315	8	M 14 x 1,5	29	14,0	27,5	12	17	EVW-L-08-SC	20,28
L	315	10	M 16 x 1,5	30	15,0	29,0	14	19	EVW-L-10-SC	26,44
L	315	12	M 18 x 1,5	32	17,0	29,5	17	22	EVW-L-12-SC	30,93
L	315	15	M 22 x 1,5	36	21,0	32,5	19	27	EVW-L-15-SC	40,58
L	315	18	M 26 x 1,5	40	23,5	35,5	24	32	EVW-L-18-SC	58,60
L	160	22	M 30 x 2	44	27,5	38,5	27	36	EVW-L-22-SC	69,99
L	160	28	M 36 x 2	47	30,5	43,5	36	41	EVW-L-28-SC	98,59
L	160	35	M 45 x 2	56	34,5	54,0	41	50	EVW-L-35-SC	148,05
L	160	42	M 52 x 2	63	40,0	56,0	50	60	EVW-L-42-SC	210,60

Reihe Series	Druck Pressure PN	Rohr A.D. Tube O.D. D1	Gewinde Thread G	Ca. Maße Approx. Dimensions					Bestellzeichen Order-Code SC	Brutto-Preis Gross-Price Euro (€)
				L1	L2	L5	SW2	SW3		
S	630	6	M 14 x 1,5	31	16,0	27,0	12	17	EVW-S-06-SC	22,61
S	630	8	M 16 x 1,5	32	17,0	27,5	14	19	EVW-S-08-SC	26,21
S	630	10	M 18 x 1,5	34	17,5	30,0	17	22	EVW-S-10-SC	30,67
S	630	12	M 20 x 1,5	38	21,5	31,0	17	24	EVW-S-12-SC	36,40
S	630	14	M 22 x 1,5	40	22,0	35,0	19	27	EVW-S-14-SC	44,56
S	400	16	M 24 x 1,5	43	24,5	36,5	24	30	EVW-S-16-SC	57,83
S	400	20	M 30 x 2	48	26,5	44,5	27	36	EVW-S-20-SC	71,84
S	400	25	M 36 x 2	54	30,0	50,0	36	46	EVW-S-25-SC	105,70
S	400	30	M 42 x 2	62	35,5	55,0	41	50	EVW-S-30-SC	151,48
S	250	38	M 52 x 2	72	41,0	63,0	50	60	EVW-S-38-SC	218,36



Einstellbare Winkel-Verschraubungen

Einsteckausführung - Vormontiert
Anschluss D1 ist vormontiert. Die Fertigmontage erfolgt im Stutzen mit ca. 1/2 Umdrehung der Überwurfmutter über den Punkt des deutlich spürbaren Kraftanstieges.

Swivel Elbows

Male Stud Type - Pre-Assembled
Port D1 is pre-assembled. Final assembly in appropriate body with approx. 1/2 turn beyond the point of clearly perceptible resistance.

Reihe Series	Druck Pressure PN	Rohr A.D. Tube O.D. D1	Gewinde Thread G	Ca. Maße Approx. Dimensions				Bestellzeichen Order-Code OMD	Brutto-Preis Gross-Price Euro (€)
L	315	6	M 12 x 1,5					EVW-L-06-OMD	16,43
L	315	8	M 14 x 1,5					EVW-L-08-OMD	16,60
L	315	10	M 16 x 1,5					EVW-L-10-OMD	22,20
L	315	12	M 18 x 1,5					EVW-L-12-OMD	25,92
L	315	15	M 22 x 1,5					EVW-L-15-OMD	33,28
L	315	18	M 26 x 1,5					EVW-L-18-OMD	46,70
L	160	22	M 30 x 2					EVW-L-22-OMD	56,16
L	160	28	M 36 x 2					EVW-L-28-OMD	79,74
L	160	35	M 45 x 2					EVW-L-35-OMD	119,50
L	160	42	M 52 x 2					EVW-L-42-OMD	174,53

Reihe Series	Druck Pressure PN	Rohr A.D. Tube O.D. D1	Gewinde Thread G	Ca. Maße Approx. Dimensions				Bestellzeichen Order-Code OMD	Brutto-Preis Gross-Price Euro (€)
S	630	6	M 14 x 1,5					EVW-S-06-OMD	18,94
S	630	8	M 16 x 1,5					EVW-S-08-OMD	22,13
S	630	10	M 18 x 1,5					EVW-S-10-OMD	25,61
S	630	12	M 20 x 1,5					EVW-S-12-OMD	30,27
S	630	14	M 22 x 1,5					EVW-S-14-OMD	35,94
S	400	16	M 24 x 1,5					EVW-S-16-OMD	46,50
S	400	20	M 30 x 2					EVW-S-20-OMD	57,50
S	400	25	M 36 x 2					EVW-S-25-OMD	81,08
S	400	30	M 42 x 2					EVW-S-30-OMD	119,72
S	250	38	M 52 x 2					EVW-S-38-OMD	175,27

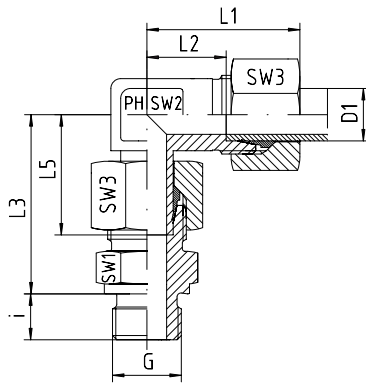

Einstellbare Winkel-Verschraubungen

Einsteckausführung - Vormontiert
Einschraubgewinde: Whitworth-Rohrgewinde - Zylindrisch
Abdichtung durch Dichtkante Form B
Der Anschluss ist vormontiert. Die Fertigmontage erfolgt im
Stutzen mit ca. 1/2 Umdrehung der Überwurfmutter über den
Punkt des deutlich spürbaren Kraftanstieges.

Swivel Elbows

Male Stud Type - Pre-Assembled
Thread: BSP - Parallel / Sealing by Sealing Shoulder Form B
The port is pre-assembled. Final assembly in appropriate
body with approx. 1/2 turn beyond the point of clearly
perceptible resistance.

Reihe Series	Druck Pressure PN	Rohr A.D. Tube O.D D1	Gewinde Thread G	Ca. Maße Approx. Dimensions								Bestellzeichen Order-Code Standard	Brutto-Preis Gross-Price Euro (€)
				L1	L2	L3	L5	i	SW1	SW2	SW3		
L	315	6	G 1/8"	27	12,0	34,5	26,0	8	14	12	14	EVW-L-06-G 1/8"	22,31
L	315	8	G 1/4"	29	14,0	37,5	27,5	12	17	12	17	EVW-L-08-G 1/4"	24,07
L	315	10	G 1/4"	30	15,0	40,0	29,0	12	19	14	19	EVW-L-10-G 1/4"	30,59
L	315	12	G 1/4"	32	17,0	42,0	29,5	12	19	17	22	EVW-L-12-G 1/4"	38,90
L	315	12	G 3/8"	32	17,0	42,0	29,5	12	22	17	22	EVW-L-12-G 3/8"	36,12
L	315	12	G 1/2"	32	17,0	43,0	29,5	14	27	17	22	EVW-L-12-G 1/2"	42,59
L	315	15	G 1/2"	36	21,0	46,5	32,5	14	27	19	27	EVW-L-15-G 1/2"	48,15
L	315	18	G 1/2"	40	23,5	50,0	35,5	14	27	24	32	EVW-L-18-G 1/2"	66,03
L	160	22	G 3/4"	44	27,5	55,0	38,5	16	32	27	36	EVW-L-22-G 3/4"	82,19
L	160	28	G 1"	47	30,5	61,0	43,5	18	41	36	41	EVW-L-28-G 1"	121,56
L	160	35	G 1 1/4"	56	34,5	71,5	54,0	20	50	41	50	EVW-L-35-G 1 1/4"	173,18
L	160	42	G 1 1/2"	63	40,0	75,0	56,0	22	55	50	60	EVW-L-42-G 1 1/2"	246,11

Reihe Series	Druck Pressure PN	Rohr A.D. Tube O.D D1	Gewinde Thread G	Ca. Maße Approx. Dimensions								Bestellzeichen Order-Code Standard	Brutto-Preis Gross-Price Euro (€)
				L1	L2	L3	L5	i	SW1	SW2	SW3		
S	630	6	G 1/4"	31	16,0	40,0	27,0	12	19	12	17	EVW-S-06-G 1/4"	26,20
S	630	8	G 1/4"	32	17,0	42,5	27,5	12	19	14	19	EVW-S-08-G 1/4"	30,63
S	630	10	G 3/8"	34	17,5	45,0	30,0	12	22	17	22	EVW-S-10-G 3/8"	36,56
S	630	12	G 3/8"	38	21,5	48,0	31,0	12	22	17	24	EVW-S-12-G 3/8"	42,13
S	630	12	G 1/2"	38	21,5	50,0	31,0	14	27	17	24	EVW-S-12-G 1/2"	47,86
S	630	14	G 1/2"	40	22,0	54,0	35,0	14	27	19	27	EVW-S-14-G 1/2"	52,61
S	400	16	G 1/2"	43	24,5	55,0	36,5	14	27	24	30	EVW-S-16-G 1/2"	67,47
S	400	20	G 3/4"	48	26,5	65,0	44,5	16	32	27	36	EVW-S-20-G 3/4"	86,03
S	400	25	G 1"	54	30,0	73,0	50,0	18	41	36	46	EVW-S-25-G 1"	130,33
S	400	30	G 1 1/4"	62	35,5	78,5	55,0	20	50	41	50	EVW-S-30-G 1 1/4"	178,52
S	250	38	G 1 1/2"	72	41,0	89,0	63,0	22	55	50	60	EVW-S-38-G 1 1/2"	249,41

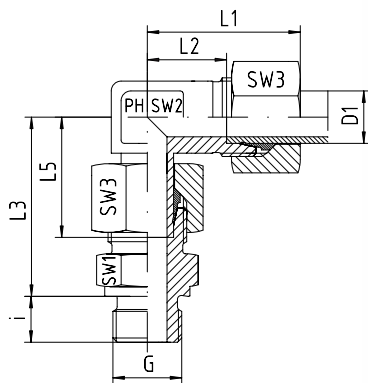

Einstellbare Winkel-Verschraubungen

Einsteckausführung - Vormontiert
Einschraubgewinde: Whitworth-Rohrgewinde - Zylindrisch
Abdichtung durch Dichtkante Form B
Der Anschluss ist vormontiert. Die Fertigmontage erfolgt im
Stutzen mit ca. 1/2 Umdrehung der Überwurfmutter über den
Punkt des deutlich spürbaren Kraftanstieges.

Swivel Elbows

Male Stud Type - Pre-Assembled
Thread: BSP - Parallel / Sealing by Sealing Shoulder Form B
The port is pre-assembled. Final assembly in appropriate
body with approx. 1/2 turn beyond the point of clearly
perceptible resistance.

Reihe Series	Druck Pressure PN	Rohr A.D. Tube O.D D1	Gewinde Thread G	Ca. Maße Approx. Dimensions								Bestellzeichen Order-Code SC	Brutto-Preis Gross-Price Euro (€)
				L1	L2	L3	L5	i	SW1	SW2	SW3		
L	315	6	G 1/8"	27	12,0	34,5	26,0	8	14	12	14	EVW-L-06-G 1/8"-SC	22,95
L	315	8	G 1/4"	29	14,0	37,5	27,5	12	17	12	17	EVW-L-08-G 1/4"-SC	24,95
L	315	10	G 1/4"	30	15,0	40,0	29,0	12	19	14	19	EVW-L-10-G 1/4"-SC	31,47
L	315	12	G 1/4"	32	17,0	42,0	29,5	12	19	17	22	EVW-L-12-G 1/4"-SC	40,02
L	315	12	G 3/8"	32	17,0	42,0	29,5	12	22	17	22	EVW-L-12-G 3/8"-SC	37,24
L	315	12	G 1/2"	32	17,0	43,0	29,5	14	27	17	22	EVW-L-12-G 1/2"-SC	43,71
L	315	15	G 1/2"	36	21,0	46,5	32,5	14	27	19	27	EVW-L-15-G 1/2"-SC	50,31
L	315	18	G 1/2"	40	23,5	50,0	35,5	14	27	24	32	EVW-L-18-G 1/2"-SC	69,31
L	160	22	G 3/4"	44	27,5	55,0	38,5	16	32	27	36	EVW-L-22-G 3/4"-SC	85,71
L	160	28	G 1"	47	30,5	61,0	43,5	18	41	36	41	EVW-L-28-G 1"-SC	125,56
L	160	35	G 1 1/4"	56	34,5	71,5	54,0	20	50	41	50	EVW-L-35-G 1 1/4"-SC	180,62
L	160	42	G 1 1/2"	63	40,0	75,0	56,0	22	55	50	60	EVW-L-42-G 1 1/2"-SC	254,75

Reihe Series	Druck Pressure PN	Rohr A.D. Tube O.D D1	Gewinde Thread G	Ca. Maße Approx. Dimensions								Bestellzeichen Order-Code SC	Brutto-Preis Gross-Price Euro (€)
				L1	L2	L3	L5	i	SW1	SW2	SW3		
S	630	6	G 1/4"	31	16,0	40,0	27,0	12	19	12	17	EVW-S-06-G 1/4"-SC	27,08
S	630	8	G 1/4"	32	17,0	42,5	27,5	12	19	14	19	EVW-S-08-G 1/4"-SC	31,51
S	630	10	G 3/8"	34	17,5	45,0	30,0	12	22	17	22	EVW-S-10-G 3/8"-SC	37,68
S	630	12	G 3/8"	38	21,5	48,0	31,0	12	22	17	24	EVW-S-12-G 3/8"-SC	43,81
S	630	12	G 1/2"	38	21,5	50,0	31,0	14	27	17	24	EVW-S-12-G 1/2"-SC	49,54
S	630	14	G 1/2"	40	22,0	54,0	35,0	14	27	19	27	EVW-S-14-G 1/2"-SC	55,73
S	400	16	G 1/2"	43	24,5	55,0	36,5	14	27	24	30	EVW-S-16-G 1/2"-SC	70,59
S	400	20	G 3/4"	48	26,5	65,0	44,5	16	32	27	36	EVW-S-20-G 3/4"-SC	89,79
S	400	25	G 1"	54	30,0	73,0	50,0	18	41	36	46	EVW-S-25-G 1"-SC	136,33
S	400	30	G 1 1/4"	62	35,5	78,5	55,0	20	50	41	50	EVW-S-30-G 1 1/4"-SC	186,84
S	250	38	G 1 1/2"	72	41,0	89,0	63,0	22	55	50	60	EVW-S-38-G 1 1/2"-SC	260,69



Einstellbare Winkel-Verschraubungen

Einsteckausführung - Vormontiert
Einschraubgewinde: Whitworth-Rohrgewinde - Zylindrisch
Abdichtung durch Dichtkante Form B
Der Anschluss ist vormontiert. Die Fertigmontage erfolgt im
Stutzen mit ca. 1/2 Umdrehung der Überwurfmutter über den
Punkt des deutlich spürbaren Kraftanstieges.

Swivel Elbows

Male Stud Type - Pre-Assembled
Thread: BSP - Parallel / Sealing by Sealing Shoulder Form B
The port is pre-assembled. Final assembly in appropriate
body with approx. 1/2 turn beyond the point of clearly
perceptible resistance.

Reihe Series	Druck Pressure PN	Rohr A.D. Tube O.D D1	Gewinde Thread G	Ca. Maße Approx. Dimensions						Bestellzeichen Order-Code OMD	Brutto-Preis Gross-Price Euro (€)
L	315	6	G 1/8"							EVW-L-06-G 1/8"-OMD	20,00
L	315	8	G 1/4"							EVW-L-08-G 1/4"-OMD	21,27
L	315	10	G 1/4"							EVW-L-10-G 1/4"-OMD	27,23
L	315	12	G 1/4"							EVW-L-12-G 1/4"-OMD	35,01
L	315	12	G 3/8"							EVW-L-12-G 3/8"-OMD	32,23
L	315	12	G 1/2"							EVW-L-12-G 1/2"-OMD	38,70
L	315	15	G 1/2"							EVW-L-15-G 1/2"-OMD	43,01
L	315	18	G 1/2"							EVW-L-18-G 1/2"-OMD	57,41
L	160	22	G 3/4"							EVW-L-22-G 3/4"-OMD	71,88
L	160	28	G 1"							EVW-L-28-G 1"-OMD	106,71
L	160	35	G 1 1/4"							EVW-L-35-G 1 1/4"-OMD	152,07
L	160	42	G 1 1/2"							EVW-L-42-G 1 1/2"-OMD	218,68

Reihe Series	Druck Pressure PN	Rohr A.D. Tube O.D D1	Gewinde Thread G	Ca. Maße Approx. Dimensions						Bestellzeichen Order-Code OMD	Brutto-Preis Gross-Price Euro (€)
S	630	6	G 1/4"							EVW-S-06-G 1/4"-OMD	23,41
S	630	8	G 1/4"							EVW-S-08-G 1/4"-OMD	27,43
S	630	10	G 3/8"							EVW-S-10-G 3/8"-OMD	32,62
S	630	12	G 3/8"							EVW-S-12-G 3/8"-OMD	37,68
S	630	12	G 1/2"							EVW-S-12-G 1/2"-OMD	43,41
S	630	14	G 1/2"							EVW-S-14-G 1/2"-OMD	47,11
S	400	16	G 1/2"							EVW-S-16-G 1/2"-OMD	59,26
S	400	20	G 3/4"							EVW-S-20-G 3/4"-OMD	75,45
S	400	25	G 1"							EVW-S-25-G 1"-OMD	111,71
S	400	30	G 1 1/4"							EVW-S-30-G 1 1/4"-OMD	155,08
S	250	38	G 1 1/2"							EVW-S-38-G 1 1/2"-OMD	217,60

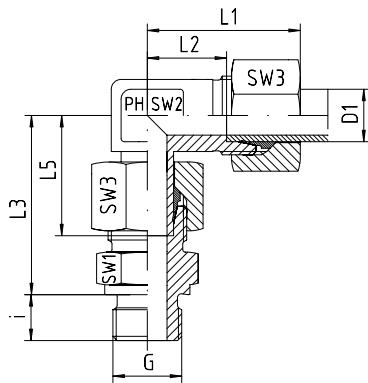

Einstellbare Winkel-Verschraubungen

Einsteckausführung - Vormontiert
Einschraubgewinde: Metrisches Feingewinde - Zylindrisch
Abdichtung durch Dichtkante Form B
Der Anschluss ist vormontiert. Die Fertigmontage erfolgt im
Stutzen mit ca. 1/2 Umdrehung der Überwurfmutter über den
Punkt des deutlich spürbaren Kraftanstieges.

Swivel Elbows

Male Stud Type - Pre-Assembled
Thread: Metric - Parallel / Sealing by Sealing Shoulder Form B
The port is pre-assembled. Final assembly in appropriate
body with approx. 1/2 turn beyond the point of clearly
perceptible resistance.

Reihe Series	Druck Pressure PN	Rohr A.D. Tube O.D. D1	Gewinde Thread G	Ca. Maße Approx. Dimensions								Bestellzeichen Order-Code Standard	Brutto-Preis Gross-Price Euro (€)
				L1	L2	L3	L5	i	SW1	SW2	SW3		
L	315	6	M 10 x 1	27	12,0	34,5	26,0	8	14	12	14	EVW-L-06-M 10x1	22,31
L	315	8	M 12 x 1,5	29	14,0	37,5	27,5	12	17	12	17	EVW-L-08-M 12x1,5	24,48
L	315	10	M 14 x 1,5	30	15,0	40,0	29,0	12	19	14	19	EVW-L-10-M 14x1,5	30,53
L	315	12	M 16 x 1,5	32	17,0	42,0	29,5	12	22	17	22	EVW-L-12-M 16x1,5	36,86
L	315	15	M 18 x 1,5	36	21,0	46,0	32,5	12	24	19	27	EVW-L-15-M 18x1,5	47,57
L	315	18	M 22 x 1,5	40	23,5	50,0	35,5	14	27	24	32	EVW-L-18-M 22x1,5	67,36
L	160	22	M 26 x 1,5	44	27,5	55,0	38,5	16	32	27	36	EVW-L-22-M 26x1,5	83,37
L	160	28	M 33 x 2	47	30,5	61,0	43,5	18	41	36	41	EVW-L-28-M 33x2	122,94
L	160	35	M 42 x 2	56	34,5	71,5	54,0	20	50	41	50	EVW-L-35-M 42x2	173,18
L	160	42	M 48 x 2	63	40,0	75,0	56,0	22	55	50	60	EVW-L-42-M 48x2	246,11

Reihe Series	Druck Pressure PN	Rohr A.D. Tube O.D. D1	Gewinde Thread G	Ca. Maße Approx. Dimensions								Bestellzeichen Order-Code Standard	Brutto-Preis Gross-Price Euro (€)
				L1	L2	L3	L5	i	SW1	SW2	SW3		
S	630	6	M 12 x 1,5	31	16,0	40,0	27,0	12	17	12	17	EVW-S-06-M 12x1,5	28,66
S	630	8	M 14 x 1,5	32	17,0	42,5	27,5	12	19	14	19	EVW-S-08-M 14x1,5	33,36
S	630	10	M 16 x 1,5	34	17,5	45,0	30,0	12	22	17	22	EVW-S-10-M 16x1,5	37,96
S	630	12	M 18 x 1,5	38	21,5	48,0	31,0	12	24	17	24	EVW-S-12-M 18x1,5	43,56
S	630	14	M 20 x 1,5	40	22,0	54,0	35,0	14	27	19	27	EVW-S-14-M 20x1,5	52,54
S	400	16	M 22 x 1,5	43	24,5	55,0	36,5	14	27	24	30	EVW-S-16-M 22x1,5	67,47
S	400	20	M 27 x 2	48	26,5	65,0	44,5	16	32	27	36	EVW-S-20-M 27x2	86,28
S	400	25	M 33 x 2	54	30,0	73,0	50,0	18	41	36	46	EVW-S-25-M 33x2	130,56
S	400	30	M 42 x 2	62	35,5	78,5	55,0	20	50	41	50	EVW-S-30-M 42x2	177,24
S	250	38	M 48 x 2	72	41,0	89,0	63,0	22	55	50	60	EVW-S-38-M 48x2	249,92

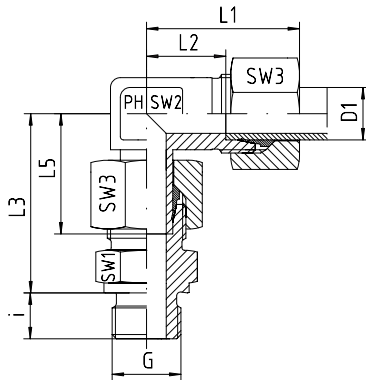

Einstellbare Winkel-Verschraubungen
Einsteckausführung - Vormontiert
Einschraubgewinde: Metrisches Feingewinde - Zylindrisch
Abdichtung durch Dichtkante Form B
Der Anschluss ist vormontiert. Die Fertigmontage erfolgt im
Stutzen mit ca. 1/2 Umdrehung der Überwurfmutter über den
Punkt des deutlich spürbaren Kraftanstieges.

Swivel Elbows
Male Stud Type - Pre-Assembled
Thread: Metric - Parallel / Sealing by Sealing Shoulder Form B
The port is pre-assembled. Final assembly in appropriate
body with approx. 1/2 turn beyond the point of clearly
perceptible resistance.

Reihe Series	Druck Pressure PN	Rohr A.D. Tube O.D. D1	Gewinde Thread G	Ca. Maße Approx. Dimensions								Bestellzeichen Order-Code SC	Brutto-Preis Gross-Price Euro (€)
				L1	L2	L3	L5	i	SW1	SW2	SW3		
L	315	6	M 10 x 1	27	12,0	34,5	26,0	8	14	12	14	EVW-L-06-M 10x1-SC	22,95
L	315	8	M 12 x 1,5	29	14,0	37,5	27,5	12	17	12	17	EVW-L-08-M 12x1,5-SC	25,36
L	315	10	M 14 x 1,5	30	15,0	40,0	29,0	12	19	14	19	EVW-L-10-M 14x1,5-SC	31,41
L	315	12	M 16 x 1,5	32	17,0	42,0	29,5	12	22	17	22	EVW-L-12-M 16x1,5-SC	37,98
L	315	15	M 18 x 1,5	36	21,0	46,0	32,5	12	24	19	27	EVW-L-15-M 18x1,5-SC	49,73
L	315	18	M 22 x 1,5	40	23,5	50,0	35,5	14	27	24	32	EVW-L-18-M 22x1,5-SC	70,64
L	160	22	M 26 x 1,5	44	27,5	55,0	38,5	16	32	27	36	EVW-L-22-M 26x1,5-SC	86,89
L	160	28	M 33 x 2	47	30,5	61,0	43,5	18	41	36	41	EVW-L-28-M 33x2-SC	126,94
L	160	35	M 42 x 2	56	34,5	71,5	54,0	20	50	41	50	EVW-L-35-M 42x2-SC	180,62
L	160	42	M 48 x 2	63	40,0	75,0	56,0	22	55	50	60	EVW-L-42-M 48x2-SC	254,75

Reihe Series	Druck Pressure PN	Rohr A.D. Tube O.D. D1	Gewinde Thread G	Ca. Maße Approx. Dimensions								Bestellzeichen Order-Code SC	Brutto-Preis Gross-Price Euro (€)
				L1	L2	L3	L5	i	SW1	SW2	SW3		
S	630	6	M 12 x 1,5	31	16,0	40,0	27,0	12	17	12	17	EVW-S-06-M 12x1,5-SC	29,54
S	630	8	M 14 x 1,5	32	17,0	42,5	27,5	12	19	14	19	EVW-S-08-M 14x1,5-SC	34,24
S	630	10	M 16 x 1,5	34	17,5	45,0	30,0	12	22	17	22	EVW-S-10-M 16x1,5-SC	39,08
S	630	12	M 18 x 1,5	38	21,5	48,0	31,0	12	24	17	24	EVW-S-12-M 18x1,5-SC	45,24
S	630	14	M 20 x 1,5	40	22,0	54,0	35,0	14	27	19	27	EVW-S-14-M 20x1,5-SC	55,66
S	400	16	M 22 x 1,5	43	24,5	55,0	36,5	14	27	24	30	EVW-S-16-M 22x1,5-SC	70,59
S	400	20	M 27 x 2	48	26,5	65,0	44,5	16	32	27	36	EVW-S-20-M 27x2-SC	90,04
S	400	25	M 33 x 2	54	30,0	73,0	50,0	18	41	36	46	EVW-S-25-M 33x2-SC	136,56
S	400	30	M 42 x 2	62	35,5	78,5	55,0	20	50	41	50	EVW-S-30-M 42x2-SC	185,56
S	250	38	M 48 x 2	72	41,0	89,0	63,0	22	55	50	60	EVW-S-38-M 48x2-SC	261,20



Einstellbare Winkel-Verschraubungen

Einsteckausführung - Vormontiert
Einschraubgewinde: Metrisches Feingewinde - Zylindrisch
Abdichtung durch Dichtkante Form B
Der Anschluss ist vormontiert. Die Fertigmontage erfolgt im Stutzen mit ca. 1/2 Umdrehung der Überwurfmutter über den Punkt des deutlich spürbaren Kraftanstieges.

Swivel Elbows

Male Stud Type - Pre-Assembled
Thread: Metric - Parallel / Sealing by Sealing Shoulder Form B
The port is pre-assembled. Final assembly in appropriate body with approx. 1/2 turn beyond the point of clearly perceptible resistance.

Reihe Series	Druck Pressure PN	Rohr A.D. Tube O.D. D1	Gewinde Thread G	Ca. Maße Approx. Dimensions						Bestellzeichen Order-Code OMD	Brutto-Preis Gross-Price Euro (€)
L	315	6	M 10 x 1							EVW-L-06-M 10x1-OMD	20,00
L	315	8	M 12 x 1,5							EVW-L-08-M 12x1,5-OMD	21,68
L	315	10	M 14 x 1,5							EVW-L-10-M 14x1,5-OMD	27,17
L	315	12	M 16 x 1,5							EVW-L-12-M 16x1,5-OMD	32,97
L	315	15	M 18 x 1,5							EVW-L-15-M 18x1,5-OMD	42,43
L	315	18	M 22 x 1,5							EVW-L-18-M 22x1,5-OMD	58,74
L	160	22	M 26 x 1,5							EVW-L-22-M 26x1,5-OMD	73,06
L	160	28	M 33 x 2							EVW-L-28-M 33x2-OMD	108,09
L	160	35	M 42 x 2							EVW-L-35-M 42x2-OMD	152,07
L	160	42	M 48 x 2							EVW-L-42-M 48x2-OMD	218,68

Reihe Series	Druck Pressure PN	Rohr A.D. Tube O.D. D1	Gewinde Thread G	Ca. Maße Approx. Dimensions						Bestellzeichen Order-Code OMD	Brutto-Preis Gross-Price Euro (€)
S	630	6	M 12 x 1,5							EVW-S-06-M 12x1,5-OMD	25,87
S	630	8	M 14 x 1,5							EVW-S-08-M 14x1,5-OMD	30,16
S	630	10	M 16 x 1,5							EVW-S-10-M 16x1,5-OMD	34,02
S	630	12	M 18 x 1,5							EVW-S-12-M 18x1,5-OMD	39,11
S	630	14	M 20 x 1,5							EVW-S-14-M 20x1,5-OMD	47,04
S	400	16	M 22 x 1,5							EVW-S-16-M 22x1,5-OMD	59,26
S	400	20	M 27 x 2							EVW-S-20-M 27x2-OMD	75,70
S	400	25	M 33 x 2							EVW-S-25-M 33x2-OMD	111,94
S	400	30	M 42 x 2							EVW-S-30-M 42x2-OMD	153,80
S	250	38	M 48 x 2							EVW-S-38-M 48x2-OMD	218,11



Einstellbare T-Verschraubungen
Einsteckausführung - Vormontiert
Anschluss D1 ist vormontiert. Die Fertigmontage erfolgt im Stutzen mit ca. 1/2 Umdrehung der Überwurfmutter über den Punkt des deutlich spürbaren Kraftanstieges.

Swivel Branch Tees
Male Stud Type - Pre-Assembled
Port D1 is pre-assembled. Final assembly in appropriate body with approx. 1/2 turn beyond the point of clearly perceptible resistance.

Reihe Series	Druck Pressure PN	Rohr A.D. Tube O.D. D1	Gewinde Thread G	Ca. Maße Approx. Dimensions					Bestellzeichen Order-Code Standard	Brutto-Preis Gross-Price Euro (€)
				L1	L2	L5	SW2	SW3		
L	315	6	M 12 x 1,5	27	12,0	26,0	12	14	EVT-L-06	30,17
L	315	8	M 14 x 1,5	29	14,0	27,5	12	17	EVT-L-08	33,29
L	315	10	M 16 x 1,5	30	15,0	29,0	14	19	EVT-L-10	37,48
L	315	12	M 18 x 1,5	32	17,0	29,5	17	22	EVT-L-12	42,18
L	315	15	M 22 x 1,5	36	21,0	32,5	19	27	EVT-L-15	55,91
L	315	18	M 26 x 1,5	40	23,5	35,5	24	32	EVT-L-18	79,25
L	160	22	M 30 x 2	44	27,5	38,5	27	36	EVT-L-22	86,92
L	160	28	M 36 x 2	47	30,5	41,5	36	41	EVT-L-28	138,05
L	160	35	M 45 x 2	56	34,5	54,0	41	50	EVT-L-35	222,42
L	160	42	M 52 x 2	63	40,0	56,0	50	60	EVT-L-42	302,18

Reihe Series	Druck Pressure PN	Rohr A.D. Tube O.D. D1	Gewinde Thread G	Ca. Maße Approx. Dimensions					Bestellzeichen Order-Code Standard	Brutto-Preis Gross-Price Euro (€)
				L1	L2	L5	SW2	SW3		
S	630	6	M 14 x 1,5	31	16,0	27,0	12	17	EVT-S-06	31,19
S	630	8	M 16 x 1,5	32	17,0	27,5	14	19	EVT-S-08	36,15
S	630	10	M 18 x 1,5	34	17,5	30,0	17	22	EVT-S-10	40,39
S	630	12	M 20 x 1,5	38	21,5	31,0	17	24	EVT-S-12	43,31
S	630	14	M 22 x 1,5	40	22,0	35,0	19	27	EVT-S-14	57,88
S	400	16	M 24 x 1,5	43	24,5	36,5	24	30	EVT-S-16	74,14
S	400	20	M 30 x 2	48	26,5	44,5	27	36	EVT-S-20	99,70
S	400	25	M 36 x 2	54	30,0	50,0	36	46	EVT-S-25	153,39
S	400	30	M 42 x 2	62	35,5	55,0	41	50	EVT-S-30	201,96
S	250	38	M 52 x 2	72	41,0	63,0	50	60	EVT-S-38	314,45

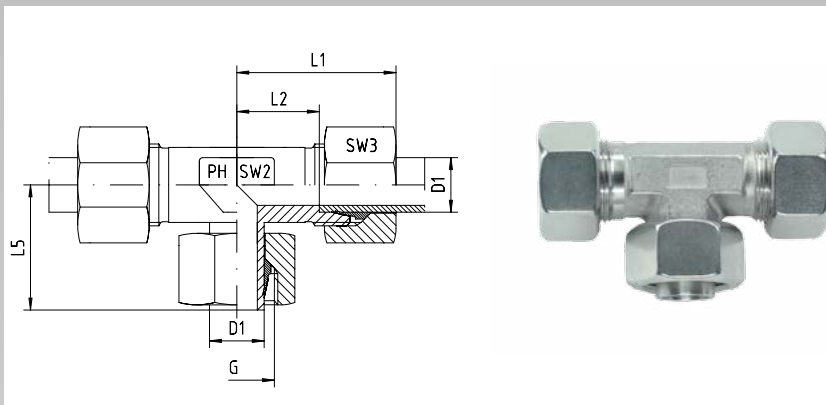

Einstellbare T-Verschraubungen
Einsteckausführung - Vormontiert
Anschluss D1 ist vormontiert. Die Fertigmontage erfolgt im
Stutzen mit ca. 1/2 Umdrehung der Überwurfmutter über den
Punkt des deutlich spürbaren Kraftanstieges.

Swivel Branch Tees
Male Stud Type - Pre-Assembled
Port D1 is pre-assembled. Final assembly in appropriate body
with approx. 1/2 turn beyond the point of clearly perceptible
resistance.

Reihe Series	Druck Pressure PN	Rohr A.D. Tube O.D. D1	Gewinde Thread G	Ca. Maße Approx. Dimensions					Bestellzeichen Order-Code SC	Brutto-Preis Gross-Price Euro (€)
				L1	L2	L5	SW2	SW3		
L	315	6	M 12 x 1,5	27	12,0	26,0	12	14	EVT-L-06-SC	31,13
L	315	8	M 14 x 1,5	29	14,0	27,5	12	17	EVT-L-08-SC	34,61
L	315	10	M 16 x 1,5	30	15,0	29,0	14	19	EVT-L-10-SC	38,80
L	315	12	M 18 x 1,5	32	17,0	29,5	17	22	EVT-L-12-SC	43,86
L	315	15	M 22 x 1,5	36	21,0	32,5	19	27	EVT-L-15-SC	59,15
L	315	18	M 26 x 1,5	40	23,5	35,5	24	32	EVT-L-18-SC	84,17
L	160	22	M 30 x 2	44	27,5	38,5	27	36	EVT-L-22-SC	92,20
L	160	28	M 36 x 2	47	30,5	41,5	36	41	EVT-L-28-SC	144,05
L	160	35	M 45 x 2	56	34,5	54,0	41	50	EVT-L-35-SC	233,58
L	160	42	M 52 x 2	63	40,0	56,0	50	60	EVT-L-42-SC	315,14

Reihe Series	Druck Pressure PN	Rohr A.D. Tube O.D. D1	Gewinde Thread G	Ca. Maße Approx. Dimensions					Bestellzeichen Order-Code SC	Brutto-Preis Gross-Price Euro (€)
				L1	L2	L5	SW2	SW3		
S	630	6	M 14 x 1,5	31	16,0	27,0	12	17	EVT-S-06-SC	32,51
S	630	8	M 16 x 1,5	32	17,0	27,5	14	19	EVT-S-08-SC	37,47
S	630	10	M 18 x 1,5	34	17,5	30,0	17	22	EVT-S-10-SC	42,07
S	630	12	M 20 x 1,5	38	21,5	31,0	17	24	EVT-S-12-SC	45,83
S	630	14	M 22 x 1,5	40	22,0	35,0	19	27	EVT-S-14-SC	62,56
S	400	16	M 24 x 1,5	43	24,5	36,5	24	30	EVT-S-16-SC	78,82
S	400	20	M 30 x 2	48	26,5	44,5	27	36	EVT-S-20-SC	105,34
S	400	25	M 36 x 2	54	30,0	50,0	36	46	EVT-S-25-SC	162,39
S	400	30	M 42 x 2	62	35,5	55,0	41	50	EVT-S-30-SC	214,44
S	250	38	M 52 x 2	72	41,0	63,0	50	60	EVT-S-38-SC	331,37



Einstellbare T-Verschraubungen

Einsteckausführung - Vormontiert

Anschluss D1 ist vormontiert. Die Fertigmontage erfolgt im Stutzen mit ca. 1/2 Umdrehung der Überwurfmutter über den Punkt des deutlich spürbaren Kraftanstieges.

Swivel Branch Tees

Male Stud Type - Pre-Assembled

Port D1 is pre-assembled. Final assembly in appropriate body with approx. 1/2 turn beyond the point of clearly perceptible resistance.

Reihe Series	Druck Pressure PN	Rohr A.D. Tube O.D. D1	Gewinde Thread G	Ca. Maße Approx. Dimensions				Bestellzeichen Order-Code OMD	Brutto-Preis Gross-Price Euro (€)
L	315	6	M 12 x 1,5					EVT-L-06-OMD	25,55
L	315	8	M 14 x 1,5					EVT-L-08-OMD	27,69
L	315	10	M 16 x 1,5					EVT-L-10-OMD	30,76
L	315	12	M 18 x 1,5					EVT-L-12-OMD	34,40
L	315	15	M 22 x 1,5					EVT-L-15-OMD	45,63
L	315	18	M 26 x 1,5					EVT-L-18-OMD	62,01
L	160	22	M 30 x 2					EVT-L-22-OMD	66,30
L	160	28	M 36 x 2					EVT-L-28-OMD	108,35
L	160	35	M 45 x 2					EVT-L-35-OMD	180,20
L	160	42	M 52 x 2					EVT-L-42-OMD	247,32

Reihe Series	Druck Pressure PN	Rohr A.D. Tube O.D. D1	Gewinde Thread G	Ca. Maße Approx. Dimensions				Bestellzeichen Order-Code OMD	Brutto-Preis Gross-Price Euro (€)
S	630	6	M 14 x 1,5					EVT-S-06-OMD	25,61
S	630	8	M 16 x 1,5					EVT-S-08-OMD	29,75
S	630	10	M 18 x 1,5					EVT-S-10-OMD	32,51
S	630	12	M 20 x 1,5					EVT-S-12-OMD	34,41
S	630	14	M 22 x 1,5					EVT-S-14-OMD	46,88
S	400	16	M 24 x 1,5					EVT-S-16-OMD	57,72
S	400	20	M 30 x 2					EVT-S-20-OMD	78,54
S	400	25	M 36 x 2					EVT-S-25-OMD	116,15
S	400	30	M 42 x 2					EVT-S-30-OMD	155,08
S	250	38	M 52 x 2					EVT-S-38-OMD	251,17

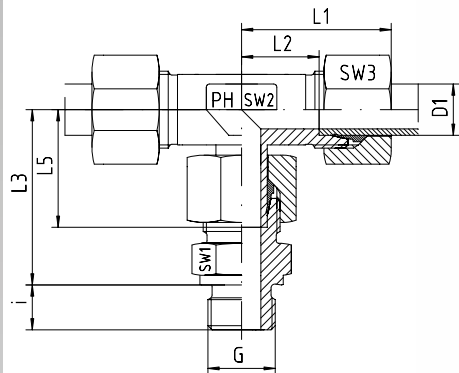

Einstellbare T-Verschraubungen
Einsteckausführung - Vormontiert
Einschraubgewinde: Whitworth-Rohrgewinde - Zylindrisch
Abdichtung durch Dichtkante Form B
Der Anschluss ist vormontiert. Die Fertigmontage erfolgt im
Stutzen mit ca. 1/2 Umdrehung der Überwurfmutter über den
Punkt des deutlich spürbaren Kraftanstieges.

Swivel Branch Tees
Male Stud Type - Pre-Assembled
Thread: BSP - Parallel / Sealing by Sealing Shoulder Form B
The port is pre-assembled. Final assembly in appropriate
body with approx. 1/2 turn beyond the point of clearly
perceptible resistance.

Reihe Series	Druck Pressure PN	Rohr A.D. Tube O.D. D1	Gewinde Thread G	Ca. Maße Approx. Dimensions								Bestellzeichen Order-Code Standard	Brutto-Preis Gross-Price Euro (€)
				L1	L2	L3	L5	i	SW1	SW2	SW3		
L	315	6	G 1/8"	27	12,0	34,5	26,0	8	14	12	14	EVT-L-06-G 1/8"	33,74
L	315	8	G 1/4"	29	14,0	37,5	27,5	12	19	12	17	EVT-L-08-G 1/4"	37,95
L	315	10	G 1/4"	30	15,0	40,0	29,0	12	19	14	19	EVT-L-10-G 1/4"	42,50
L	315	12	G 3/8"	32	17,0	42,0	29,5	12	22	17	22	EVT-L-12-G 3/8"	48,49
L	315	15	G 1/2"	36	21,0	46,5	32,5	14	27	19	27	EVT-L-15-G 1/2"	65,64
L	315	18	G 1/2"	40	23,5	50,0	35,5	14	27	24	32	EVT-L-18-G 1/2"	89,96
L	160	22	G 3/4"	44	27,5	65,0	38,5	16	32	27	36	EVT-L-22-G 3/4"	102,64
L	160	28	G 1"	47	30,5	69,0	41,5	18	41	36	41	EVT-L-28-G 1"	165,02
L	160	35	G 1 1/4"	56	34,5	71,5	54,0	20	50	41	50	EVT-L-35-G 1 1/4"	254,99
L	160	42	G 1 1/2"	63	40,0	75,0	56,0	22	55	50	60	EVT-L-42-G 1 1/2"	346,33

Reihe Series	Druck Pressure PN	Rohr A.D. Tube O.D. D1	Gewinde Thread G	Ca. Maße Approx. Dimensions								Bestellzeichen Order-Code Standard	Brutto-Preis Gross-Price Euro (€)
				L1	L2	L3	L5	i	SW1	SW2	SW3		
S	630	6	G 1/4"	31	16,0	40,0	27,0	12	19	12	17	EVT-S-06-G 1/4"	35,66
S	630	8	G 1/4"	32	17,0	42,5	27,5	12	19	14	19	EVT-S-08-G 1/4"	41,44
S	630	10	G 3/8"	34	17,5	45,0	30,0	12	22	17	22	EVT-S-10-G 3/8"	47,40
S	630	12	G 3/8"	38	21,5	48,0	31,0	12	22	17	24	EVT-S-12-G 3/8"	50,73
S	630	14	G 1/2"	40	22,0	54,0	35,0	14	27	19	27	EVT-S-14-G 1/2"	69,05
S	400	16	G 1/2"	43	24,5	55,0	36,5	14	27	24	30	EVT-S-16-G 1/2"	86,90
S	400	20	G 3/4"	48	26,5	65,0	44,5	16	32	27	36	EVT-S-20-G 3/4"	117,65
S	400	25	G 1"	54	30,0	73,0	50,0	18	41	36	46	EVT-S-25-G 1"	184,02
S	400	30	G 1 1/4"	62	35,5	78,5	55,0	20	50	41	50	EVT-S-30-G 1 1/4"	237,32
S	250	38	G 1 1/2"	72	41,0	89,0	63,0	22	55	50	60	EVT-S-38-G 1 1/2"	356,78

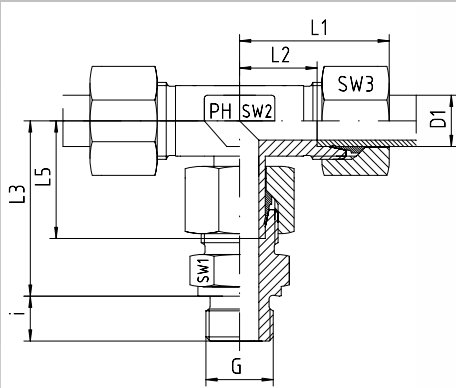

Einstellbare T-Verschraubungen
Einsteckausführung - Vormontiert
Einschraubgewinde: Whitworth-Rohrgewinde - Zylindrisch
Abdichtung durch Dichtkante Form B
Der Anschluss ist vormontiert. Die Fertigmontage erfolgt im
Stutzen mit ca. 1/2 Umdrehung der Überwurfmutter über den
Punkt des deutlich spürbaren Kraftanstieges.

Swivel Branch Tees
Male Stud Type - Pre-Assembled
Thread: BSP - Parallel / Sealing by Sealing Shoulder Form B
The port is pre-assembled. Final assembly in appropriate
body with approx. 1/2 turn beyond the point of clearly
perceptible resistance.

Reihe Series	Druck Pressure PN	Rohr A.D. Tube O.D. D1	Gewinde Thread G	Ca. Maße Approx. Dimensions								Bestellzeichen Order-Code SC	Brutto-Preis Gross-Price Euro (€)
				L1	L2	L3	L5	i	SW1	SW2	SW3		
L	315	6	G 1/8"	27	12,0	34,5	26,0	8	14	12	14	EVT-L-06-G 1/8"-SC	34,70
L	315	8	G 1/4"	29	14,0	37,5	27,5	12	19	12	17	EVT-L-08-G 1/4"-SC	39,27
L	315	10	G 1/4"	30	15,0	40,0	29,0	12	19	14	19	EVT-L-10-G 1/4"-SC	43,82
L	315	12	G 3/8"	32	17,0	42,0	29,5	12	22	17	22	EVT-L-12-G 3/8"-SC	50,17
L	315	15	G 1/2"	36	21,0	46,5	32,5	14	27	19	27	EVT-L-15-G 1/2"-SC	68,88
L	315	18	G 1/2"	40	23,5	50,0	35,5	14	27	24	32	EVT-L-18-G 1/2"-SC	94,88
L	160	22	G 3/4"	44	27,5	65,0	38,5	16	32	27	36	EVT-L-22-G 3/4"-SC	107,92
L	160	28	G 1"	47	30,5	69,0	41,5	18	41	36	41	EVT-L-28-G 1"-SC	171,02
L	160	35	G 1 1/4"	56	34,5	71,5	54,0	20	50	41	50	EVT-L-35-G 1 1/4"-SC	266,15
L	160	42	G 1 1/2"	63	40,0	75,0	56,0	22	55	50	60	EVT-L-42-G 1 1/2"-SC	359,29

Reihe Series	Druck Pressure PN	Rohr A.D. Tube O.D. D1	Gewinde Thread G	Ca. Maße Approx. Dimensions								Bestellzeichen Order-Code SC	Brutto-Preis Gross-Price Euro (€)
				L1	L2	L3	L5	i	SW1	SW2	SW3		
S	630	6	G 1/4"	31	16,0	40,0	27,0	12	19	12	17	EVT-S-06-G 1/4"-SC	36,98
S	630	8	G 1/4"	32	17,0	42,5	27,5	12	19	14	19	EVT-S-08-G 1/4"-SC	42,76
S	630	10	G 3/8"	34	17,5	45,0	30,0	12	22	17	22	EVT-S-10-G 3/8"-SC	49,08
S	630	12	G 3/8"	38	21,5	48,0	31,0	12	22	17	24	EVT-S-12-G 3/8"-SC	53,25
S	630	14	G 1/2"	40	22,0	54,0	35,0	14	27	19	27	EVT-S-14-G 1/2"-SC	73,73
S	400	16	G 1/2"	43	24,5	55,0	36,5	14	27	24	30	EVT-S-16-G 1/2"-SC	91,58
S	400	20	G 3/4"	48	26,5	65,0	44,5	16	32	27	36	EVT-S-20-G 3/4"-SC	123,29
S	400	25	G 1"	54	30,0	73,0	50,0	18	41	36	46	EVT-S-25-G 1"-SC	193,02
S	400	30	G 1 1/4"	62	35,5	78,5	55,0	20	50	41	50	EVT-S-30-G 1 1/4"-SC	249,80
S	250	38	G 1 1/2"	72	41,0	89,0	63,0	22	55	50	60	EVT-S-38-G 1 1/2"-SC	373,70



Einstellbare T-Verschraubungen

Einsteckausführung - Vormontiert
Einschraubgewinde: Whitworth-Rohrgewinde - Zylindrisch
Abdichtung durch Dichtkante Form B
Der Anschluss ist vormontiert. Die Fertigmontage erfolgt im
Stutzen mit ca. 1/2 Umdrehung der Überwurfmutter über den
Punkt des deutlich spürbaren Kraftanstieges.

Swivel Branch Tees

Male Stud Type - Pre-Assembled
Thread: BSP - Parallel / Sealing by Sealing Shoulder Form B
The port is pre-assembled. Final assembly in appropriate
body with approx. 1/2 turn beyond the point of clearly
perceptible resistance.

Reihe Series	Druck Pressure PN	Rohr A.D. Tube O.D. D1	Gewinde Thread G	Ca. Maße Approx. Dimensions						Bestellzeichen Order-Code OMD	Brutto-Preis Gross-Price Euro (€)
L	315	6	G 1/8"							EVT-L-06-G 1/8"-OMD	29,12
L	315	8	G 1/4"							EVT-L-08-G 1/4"-OMD	32,35
L	315	10	G 1/4"							EVT-L-10-G 1/4"-OMD	35,78
L	315	12	G 3/8"							EVT-L-12-G 3/8"-OMD	40,71
L	315	15	G 1/2"							EVT-L-15-G 1/2"-OMD	55,36
L	315	18	G 1/2"							EVT-L-18-G 1/2"-OMD	72,72
L	160	22	G 3/4"							EVT-L-22-G 3/4"-OMD	82,02
L	160	28	G 1"							EVT-L-28-G 1"-OMD	135,32
L	160	35	G 1 1/4"							EVT-L-35-G 1 1/4"-OMD	212,77
L	160	42	G 1 1/2"							EVT-L-42-G 1 1/2"-OMD	291,47

Reihe Series	Druck Pressure PN	Rohr A.D. Tube O.D. D1	Gewinde Thread G	Ca. Maße Approx. Dimensions						Bestellzeichen Order-Code OMD	Brutto-Preis Gross-Price Euro (€)
S	630	6	G 1/4"							EVT-S-06-G 1/4"-OMD	30,08
S	630	8	G 1/4"							EVT-S-08-G 1/4"-OMD	35,04
S	630	10	G 3/8"							EVT-S-10-G 3/8"-OMD	39,52
S	630	12	G 3/8"							EVT-S-12-G 3/8"-OMD	41,83
S	630	14	G 1/2"							EVT-S-14-G 1/2"-OMD	58,05
S	400	16	G 1/2"							EVT-S-16-G 1/2"-OMD	70,48
S	400	20	G 3/4"							EVT-S-20-G 3/4"-OMD	96,49
S	400	25	G 1"							EVT-S-25-G 1"-OMD	146,78
S	400	30	G 1 1/4"							EVT-S-30-G 1 1/4"-OMD	190,44
S	250	38	G 1 1/2"							EVT-S-38-G 1 1/2"-OMD	293,50

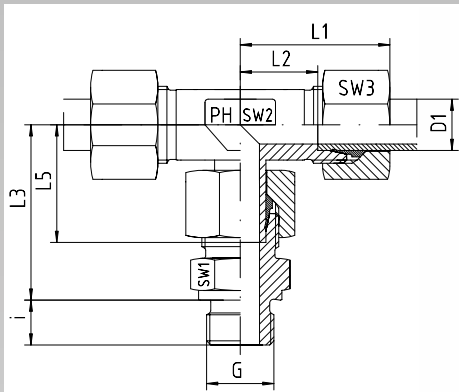

Einstellbare T-Verschraubungen
Einsteckausführung - Vormontiert
Einschraubgewinde: Metrisches Feingewinde - Zylindrisch
Abdichtung durch Dichtkante Form B
Der Anschluss ist vormontiert. Die Fertigmontage erfolgt im
Stutzen mit ca. 1/2 Umdrehung der Überwurfmutter über den
Punkt des deutlich spürbaren Kraftanstieges.

Swivel Branch Tees
Male Stud Type - Pre-Assembled
Thread: Metric - Parallel / Sealing by Sealing Shoulder Form B
The port is pre-assembled. Final assembly in appropriate
body with approx. 1/2 turn beyond the point of clearly
perceptible resistance.

Reihe Series	Druck Pressure PN	Rohr A.D. Tube O.D. D1	Gewinde Thread G	Ca. Maße Approx. Dimensions								Bestellzeichen Order-Code Standard	Brutto-Preis Gross-Price Euro (€)
				L1	L2	L3	L5	i	SW1	SW2	SW3		
L	315	6	M 10 x 1	27	12,0	34,5	26,0	8	14	12	14	EVT-L-06-M 10x1	33,74
L	315	8	M 12 x 1,5	29	14,0	37,5	27,5	12	17	12	17	EVT-L-08-M 12x1,5	38,36
L	315	10	M 14 x 1,5	30	15,0	40,0	29,0	12	19	14	19	EVT-L-10-M 14x1,5	42,45
L	315	12	M 16 x 1,5	32	17,0	42,0	29,5	12	22	17	22	EVT-L-12-M 16x1,5	49,23
L	315	15	M 18 x 1,5	36	21,0	46,0	32,5	12	24	19	27	EVT-L-15-M 18x1,5	65,05
L	315	18	M 22 x 1,5	40	23,5	50,0	35,5	14	27	24	32	EVT-L-18-M 22x1,5	91,29
L	160	22	M 26 x 1,5	44	27,5	55,0	38,5	16	32	27	36	EVT-L-22-M 26x1,5	103,82
L	160	28	M 33 x 2	47	30,5	59,0	41,5	18	41	36	41	EVT-L-28-M 33x2	166,40
L	160	35	M 42 x 2	56	34,5	71,5	54,0	20	50	41	50	EVT-L-35-M 42x2	254,99
L	160	42	M 48 x 2	63	40,0	75,0	56,0	22	55	50	60	EVT-L-42-M 48x2	346,33

Reihe Series	Druck Pressure PN	Rohr A.D. Tube O.D. D1	Gewinde Thread G	Ca. Maße Approx. Dimensions								Bestellzeichen Order-Code Standard	Brutto-Preis Gross-Price Euro (€)
				L1	L2	L3	L5	i	SW1	SW2	SW3		
S	630	6	M 12 x 1,5	31	16,0	40,0	27,0	12	17	12	17	EVT-S-06-M 12x1,5	38,12
S	630	8	M 14 x 1,5	32	17,0	42,5	27,5	12	19	14	19	EVT-S-08-M 14x1,5	44,18
S	630	10	M 16 x 1,5	34	17,5	45,0	30,0	12	22	17	22	EVT-S-10-M 16x1,5	48,80
S	630	12	M 18 x 1,5	38	21,5	48,0	31,0	12	24	17	24	EVT-S-12-M 18x1,5	52,15
S	630	14	M 20 x 1,5	40	22,0	54,0	35,0	14	27	19	27	EVT-S-14-M 20x1,5	68,97
S	400	16	M 22 x 1,5	43	24,5	55,0	36,5	14	27	24	30	EVT-S-16-M 22x1,5	86,90
S	400	20	M 27 x 2	48	26,5	65,0	44,5	16	32	27	36	EVT-S-20-M 27x2	117,91
S	400	25	M 33 x 2	54	30,0	73,0	50,0	18	41	36	46	EVT-S-25-M 33x2	184,25
S	400	30	M 42 x 2	62	35,5	78,5	55,0	20	50	41	50	EVT-S-30-M 42x2	236,04
S	250	38	M 48 x 2	72	41,0	89,0	63,0	22	55	50	60	EVT-S-38-M 48x2	357,30

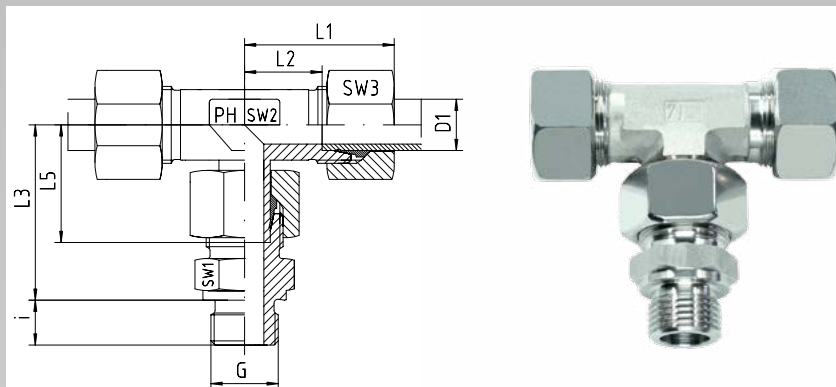

Einstellbare T-Verschraubungen
Einsteckausführung - Vormontiert
Einschraubgewinde: Metrisches Feingewinde - Zylindrisch
Abdichtung durch Dichtkante Form B
Der Anschluss ist vormontiert. Die Fertigmontage erfolgt im
Stutzen mit ca. 1/2 Umdrehung der Überwurfmutter über den
Punkt des deutlich spürbaren Kraftanstieges.

Swivel Branch Tees
Male Stud Type - Pre-Assembled
Thread: Metric - Parallel / Sealing by Sealing Shoulder Form B
The port is pre-assembled. Final assembly in appropriate
body with approx. 1/2 turn beyond the point of clearly
perceptible resistance.

Reihe Series	Druck Pressure PN	Rohr A.D. Tube O.D. D1	Gewinde Thread G	Ca. Maße Approx. Dimensions								Bestellzeichen Order-Code SC	Brutto-Preis Gross-Price Euro (€)
				L1	L2	L3	L5	i	SW1	SW2	SW3		
L	315	6	M 10 x 1	27	12,0	34,5	26,0	8	14	12	14	EVT-L-06-M 10x1-SC	34,70
L	315	8	M 12 x 1,5	29	14,0	37,5	27,5	12	17	12	17	EVT-L-08-M 12x1,5-SC	39,68
L	315	10	M 14 x 1,5	30	15,0	40,0	29,0	12	19	14	19	EVT-L-10-M 14x1,5-SC	43,77
L	315	12	M 16 x 1,5	32	17,0	42,0	29,5	12	22	17	22	EVT-L-12-M 16x1,5-SC	50,91
L	315	15	M 18 x 1,5	36	21,0	46,0	32,5	12	24	19	27	EVT-L-15-M 18x1,5-SC	68,29
L	315	18	M 22 x 1,5	40	23,5	50,0	35,5	14	27	24	32	EVT-L-18-M 22x1,5-SC	96,21
L	160	22	M 26 x 1,5	44	27,5	55,0	38,5	16	32	27	36	EVT-L-22-M 26x1,5-SC	109,10
L	160	28	M 33 x 2	47	30,5	59,0	41,5	18	41	36	41	EVT-L-28-M 33x2-SC	172,40
L	160	35	M 42 x 2	56	34,5	71,5	54,0	20	50	41	50	EVT-L-35-M 42x2-SC	266,15
L	160	42	M 48 x 2	63	40,0	75,0	56,0	22	55	50	60	EVT-L-42-M 48x2-SC	359,29

Reihe Series	Druck Pressure PN	Rohr A.D. Tube O.D. D1	Gewinde Thread G	Ca. Maße Approx. Dimensions								Bestellzeichen Order-Code SC	Brutto-Preis Gross-Price Euro (€)
				L1	L2	L3	L5	i	SW1	SW2	SW3		
S	630	6	M 12 x 1,5	31	16,0	40,0	27,0	12	17	12	17	EVT-S-06-M 12x1,5-SC	39,44
S	630	8	M 14 x 1,5	32	17,0	42,5	27,5	12	19	14	19	EVT-S-08-M 14x1,5-SC	45,50
S	630	10	M 16 x 1,5	34	17,5	45,0	30,0	12	22	17	22	EVT-S-10-M 16x1,5-SC	50,48
S	630	12	M 18 x 1,5	38	21,5	48,0	31,0	12	24	17	24	EVT-S-12-M 18x1,5-SC	54,67
S	630	14	M 20 x 1,5	40	22,0	54,0	35,0	14	27	19	27	EVT-S-14-M 20x1,5-SC	73,65
S	400	16	M 22 x 1,5	43	24,5	55,0	36,5	14	27	24	30	EVT-S-16-M 22x1,5-SC	91,58
S	400	20	M 27 x 2	48	26,5	65,0	44,5	16	32	27	36	EVT-S-20-M 27x2-SC	123,55
S	400	25	M 33 x 2	54	30,0	73,0	50,0	18	41	36	46	EVT-S-25-M 33x2-SC	193,25
S	400	30	M 42 x 2	62	35,5	78,5	55,0	20	50	41	50	EVT-S-30-M 42x2-SC	248,52
S	250	38	M 48 x 2	72	41,0	89,0	63,0	22	55	50	60	EVT-S-38-M 48x2-SC	374,22



Einstellbare T-Verschraubungen

Einsteckausführung - Vormontiert
 Einschraubgewinde: Metrisches Feingewinde - Zylindrisch
 Abdichtung durch Dichtkante Form B
 Der Anschluss ist vormontiert. Die Fertigmontage erfolgt im
 Stutzen mit ca. 1/2 Umdrehung der Überwurfmutter über den
 Punkt des deutlich spürbaren Kraftanstieges.

Swivel Branch Tees

Male Stud Type - Pre-Assembled
 Thread: Metric - Parallel / Sealing by Sealing Shoulder Form B
 The port is pre-assembled. Final assembly in appropriate
 body with approx. 1/2 turn beyond the point of clearly
 perceptible resistance.

Reihe Series	Druck Pressure PN	Rohr A.D. Tube O.D. D1	Gewinde Thread G	Ca. Maße Approx. Dimensions						Bestellzeichen Order-Code OMD	Brutto-Preis Gross-Price Euro (€)
L	315	6	M 10 x 1							EVT-L-06-M 10x1-OMD	29,12
L	315	8	M 12 x 1,5							EVT-L-08-M 12x1,5-OMD	32,76
L	315	10	M 14 x 1,5							EVT-L-10-M 14x1,5-OMD	35,73
L	315	12	M 16 x 1,5							EVT-L-12-M 16x1,5-OMD	41,45
L	315	15	M 18 x 1,5							EVT-L-15-M 18x1,5-OMD	54,77
L	315	18	M 22 x 1,5							EVT-L-18-M 22x1,5-OMD	74,05
L	160	22	M 26 x 1,5							EVT-L-22-M 26x1,5-OMD	83,20
L	160	28	M 33 x 2							EVT-L-28-M 33x2-OMD	136,70
L	160	35	M 42 x 2							EVT-L-35-M 42x2-OMD	212,77
L	160	42	M 48 x 2							EVT-L-42-M 48x2-OMD	291,47

Reihe Series	Druck Pressure PN	Rohr A.D. Tube O.D. D1	Gewinde Thread G	Ca. Maße Approx. Dimensions						Bestellzeichen Order-Code OMD	Brutto-Preis Gross-Price Euro (€)
S	630	6	M 12 x 1,5							EVT-S-06-M 12x1,5-OMD	32,54
S	630	8	M 14 x 1,5							EVT-S-08-M 14x1,5-OMD	37,78
S	630	10	M 16 x 1,5							EVT-S-10-M 16x1,5-OMD	40,92
S	630	12	M 18 x 1,5							EVT-S-12-M 18x1,5-OMD	43,25
S	630	14	M 20 x 1,5							EVT-S-14-M 20x1,5-OMD	57,97
S	400	16	M 22 x 1,5							EVT-S-16-M 22x1,5-OMD	70,48
S	400	20	M 27 x 2							EVT-S-20-M 27x2-OMD	96,75
S	400	25	M 33 x 2							EVT-S-25-M 33x2-OMD	147,01
S	400	30	M 42 x 2							EVT-S-30-M 42x2-OMD	189,16
S	250	38	M 48 x 2							EVT-S-38-M 48x2-OMD	294,02



Einstellbare L-Verschraubungen
Einsteckausführung - Vormontiert
Anschluss D1 ist vormontiert. Die Fertigmontage erfolgt im Stutzen mit ca. 1/2 Umdrehung der Überwurfmutter über den Punkt des deutlich spürbaren Kraftanstieges.

Swivel Barrel Tees
Male Stud Type - Pre-Assembled
Port D1 is pre-assembled. Final assembly in appropriate body with approx. 1/2 turn beyond the point of clearly perceptible resistance.

Reihe Series	Druck Pressure PN	Rohr A.D. Tube O.D. D1	Gewinde Thread G	Ca. Maße Approx. Dimensions					Bestellzeichen Order-Code Standard	Brutto-Preis Gross-Price Euro (€)
				L1	L2	L5	SW2	SW3		
L	315	6	M 12 x 1,5	27	12,0	26,0	12	14	EVL-L-06	30,17
L	315	8	M 14 x 1,5	29	14,0	27,5	12	17	EVL-L-08	33,29
L	315	10	M 16 x 1,5	30	15,0	29,0	14	19	EVL-L-10	37,48
L	315	12	M 18 x 1,5	32	17,0	29,5	17	22	EVL-L-12	43,74
L	315	15	M 22 x 1,5	36	21,0	32,5	19	27	EVL-L-15	57,93
L	315	18	M 26 x 1,5	40	23,5	35,5	24	32	EVL-L-18	94,59
L	160	22	M 30 x 2	44	27,5	38,5	27	36	EVL-L-22	99,70
L	160	28	M 36 x 2	47	30,5	43,5	36	41	EVL-L-28	171,29
L	160	35	M 45 x 2	56	34,5	54,0	41	50	EVL-L-35	253,09
L	160	42	M 52 x 2	63	40,0	56,0	50	60	EVL-L-42	332,34

Reihe Series	Druck Pressure PN	Rohr A.D. Tube O.D. D1	Gewinde Thread G	Ca. Maße Approx. Dimensions					Bestellzeichen Order-Code Standard	Brutto-Preis Gross-Price Euro (€)
				L1	L2	L5	SW2	SW3		
S	630	6	M 14 x 1,5	31	16,0	27,0	12	17	EVL-S-06	31,75
S	630	8	M 16 x 1,5	32	17,0	27,5	14	19	EVL-S-08	35,54
S	630	10	M 18 x 1,5	34	17,5	30,0	17	22	EVL-S-10	45,61
S	630	12	M 20 x 1,5	38	21,5	31,0	17	24	EVL-S-12	50,72
S	630	14	M 22 x 1,5	40	22,0	35,0	19	27	EVL-S-14	58,80
S	400	16	M 24 x 1,5	43	24,5	36,5	24	30	EVL-S-16	94,59
S	400	20	M 30 x 2	48	26,5	44,5	27	36	EVL-S-20	115,04
S	400	25	M 36 x 2	54	30,0	50,0	36	46	EVL-S-25	184,07
S	400	30	M 42 x 2	62	35,5	55,0	41	50	EVL-S-30	230,08
S	250	38	M 52 x 2	72	41,0	63,0	50	60	EVL-S-38	332,34

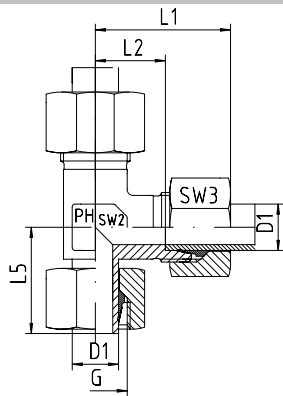

Einstellbare L-Verschraubungen
Einsteckausführung - Vormontiert
Anschluss D1 ist vormontiert. Die Fertigmontage erfolgt im Stutzen mit ca. 1/2 Umdrehung der Überwurfmutter über den Punkt des deutlich spürbaren Kraftanstieges.

Swivel Barrel Tees
Male Stud Type - Pre-Assembled
Port D1 is pre-assembled. Final assembly in appropriate body with approx. 1/2 turn beyond the point of clearly perceptible resistance.

Reihe Series	Druck Pressure PN	Rohr A.D. Tube O.D. D1	Gewinde Thread G	Ca. Maße Approx. Dimensions					Bestellzeichen Order-Code SC	Brutto-Preis Gross-Price Euro (€)
				L1	L2	L5	SW2	SW3		
L	315	6	M 12 x 1,5	27	12,0	26,0	12	14	EVL-L-06-SC	31,13
L	315	8	M 14 x 1,5	29	14,0	27,5	12	17	EVL-L-08-SC	34,61
L	315	10	M 16 x 1,5	30	15,0	29,0	14	19	EVL-L-10-SC	38,80
L	315	12	M 18 x 1,5	32	17,0	29,5	17	22	EVL-L-12-SC	45,42
L	315	15	M 22 x 1,5	36	21,0	32,5	19	27	EVL-L-15-SC	61,17
L	315	18	M 26 x 1,5	40	23,5	35,5	24	32	EVL-L-18-SC	99,51
L	160	22	M 30 x 2	44	27,5	38,5	27	36	EVL-L-22-SC	104,98
L	160	28	M 36 x 2	47	30,5	43,5	36	41	EVL-L-28-SC	177,29
L	160	35	M 45 x 2	56	34,5	54,0	41	50	EVL-L-35-SC	264,25
L	160	42	M 52 x 2	63	40,0	56,0	50	60	EVL-L-42-SC	345,30

Reihe Series	Druck Pressure PN	Rohr A.D. Tube O.D. D1	Gewinde Thread G	Ca. Maße Approx. Dimensions					Bestellzeichen Order-Code SC	Brutto-Preis Gross-Price Euro (€)
				L1	L2	L5	SW2	SW3		
S	630	6	M 14 x 1,5	31	16,0	27,0	12	17	EVL-S-06-SC	33,07
S	630	8	M 16 x 1,5	32	17,0	27,5	14	19	EVL-S-08-SC	36,86
S	630	10	M 18 x 1,5	34	17,5	30,0	17	22	EVL-S-10-SC	47,29
S	630	12	M 20 x 1,5	38	21,5	31,0	17	24	EVL-S-12-SC	53,24
S	630	14	M 22 x 1,5	40	22,0	35,0	19	27	EVL-S-14-SC	63,48
S	400	16	M 24 x 1,5	43	24,5	36,5	24	30	EVL-S-16-SC	99,27
S	400	20	M 30 x 2	48	26,5	44,5	27	36	EVL-S-20-SC	120,68
S	400	25	M 36 x 2	54	30,0	50,0	36	46	EVL-S-25-SC	193,07
S	400	30	M 42 x 2	62	35,5	55,0	41	50	EVL-S-30-SC	242,56
S	250	38	M 52 x 2	72	41,0	63,0	50	60	EVL-S-38-SC	349,26



Einstellbare L-Verschraubungen
Einsteckausführung - Vormontiert
Anschluss D1 ist vormontiert. Die Fertigmontage erfolgt im Stutzen mit ca. 1/2 Umdrehung der Überwurfmutter über den Punkt des deutlich spürbaren Kraftanstieges.

Swivel Barrel Tees
Male Stud Type - Pre-Assembled
Port D1 is pre-assembled. Final assembly in appropriate body with approx. 1/2 turn beyond the point of clearly perceptible resistance.

Reihe Series	Druck Pressure PN	Rohr A.D. Tube O.D. D1	Gewinde Thread G	Ca. Maße Approx. Dimensions				Bestellzeichen Order-Code OMD	Brutto-Preis Gross-Price Euro (€)
L	315	6	M 12 x 1,5					EVL-L-06-OMD	25,55
L	315	8	M 14 x 1,5					EVL-L-08-OMD	27,69
L	315	10	M 16 x 1,5					EVL-L-10-OMD	30,76
L	315	12	M 18 x 1,5					EVL-L-12-OMD	35,96
L	315	15	M 22 x 1,5					EVL-L-15-OMD	47,65
L	315	18	M 26 x 1,5					EVL-L-18-OMD	77,35
L	160	22	M 30 x 2					EVL-L-22-OMD	79,08
L	160	28	M 36 x 2					EVL-L-28-OMD	141,59
L	160	35	M 45 x 2					EVL-L-35-OMD	210,87
L	160	42	M 52 x 2					EVL-L-42-OMD	277,48

Reihe Series	Druck Pressure PN	Rohr A.D. Tube O.D. D1	Gewinde Thread G	Ca. Maße Approx. Dimensions				Bestellzeichen Order-Code OMD	Brutto-Preis Gross-Price Euro (€)
S	630	6	M 14 x 1,5					EVL-S-06-OMD	26,17
S	630	8	M 16 x 1,5					EVL-S-08-OMD	29,14
S	630	10	M 18 x 1,5					EVL-S-10-OMD	37,73
S	630	12	M 20 x 1,5					EVL-S-12-OMD	41,82
S	630	14	M 22 x 1,5					EVL-S-14-OMD	47,80
S	400	16	M 24 x 1,5					EVL-S-16-OMD	78,17
S	400	20	M 30 x 2					EVL-S-20-OMD	93,88
S	400	25	M 36 x 2					EVL-S-25-OMD	146,83
S	400	30	M 42 x 2					EVL-S-30-OMD	183,20
S	250	38	M 52 x 2					EVL-S-38-OMD	269,06

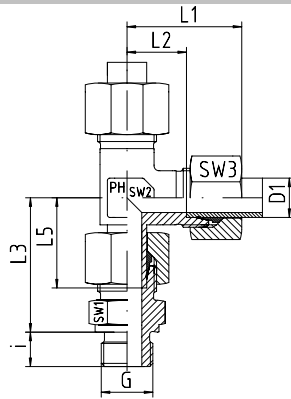

Einstellbare L-Verschraubungen
Einsteckausführung - Vormontiert
Einschraubgewinde: Whitworth-Rohrgewinde - Zylindrisch
Abdichtung durch Dichtkante Form B
Der Anschluss ist vormontiert. Die Fertigmontage erfolgt im
Stutzen mit ca. 1/2 Umdrehung der Überwurfmutter über den
Punkt des deutlich spürbaren Kraftanstieges.

Swivel Barrel Tees
Male Stud Type - Pre-Assembled
Thread: BSP - Parallel / Sealing by Sealing Shoulder Form B
The port is pre-assembled. Final assembly in appropriate
body with approx. 1/2 turn beyond the point of clearly
perceptible resistance.

Reihe Series	Druck Pressure PN	Rohr A.D. Tube O.D. D1	Gewinde Thread G	Ca. Maße Approx. Dimensions								Bestellzeichen Order-Code Standard	Brutto-Preis Gross-Price Euro (€)
				L1	L2	L3	L5	i	SW1	SW2	SW3		
L	315	6	G 1/8"	27	12,0	34,5	26,0	8	14	12	14	EVL-L-06-G 1/8"	33,74
L	315	8	G 1/4"	29	14,0	37,5	27,5	12	19	12	17	EVL-L-08-G 1/4"	37,95
L	315	10	G 1/4"	30	15,0	40,0	29,0	12	19	14	19	EVL-L-10-G 1/4"	42,50
L	315	12	G 3/8"	32	17,0	42,0	29,5	12	22	17	22	EVL-L-12-G 3/8"	50,05
L	315	15	G 1/2"	36	21,0	46,5	32,5	14	27	19	27	EVL-L-15-G 1/2"	67,66
L	315	18	G 1/2"	40	23,5	50,0	35,5	14	27	24	32	EVL-L-18-G 1/2"	105,30
L	160	22	G 3/4"	44	27,5	55,0	38,5	16	32	27	36	EVL-L-22-G 3/4"	115,43
L	160	28	G 1"	47	30,5	61,0	43,5	18	41	36	41	EVL-L-28-G 1"	198,26
L	160	35	G 1 1/4"	56	34,5	71,5	54,0	20	50	41	50	EVL-L-35-G 1 1/4"	285,66
L	160	42	G 1 1/2"	63	40,0	75,0	56,0	22	55	50	60	EVL-L-42-G 1 1/2"	376,50

Reihe Series	Druck Pressure PN	Rohr A.D. Tube O.D. D1	Gewinde Thread G	Ca. Maße Approx. Dimensions								Bestellzeichen Order-Code Standard	Brutto-Preis Gross-Price Euro (€)
				L1	L2	L3	L5	i	SW1	SW2	SW3		
S	630	6	G 1/4"	31	16,0	40,0	27,0	12	19	12	17	EVL-S-06-G 1/4"	36,23
S	630	8	G 1/4"	32	17,0	42,5	27,5	12	19	14	19	EVL-S-08-G 1/4"	40,83
S	630	10	G 3/8"	34	17,5	45,0	30,0	12	22	17	22	EVL-S-10-G 3/8"	52,61
S	630	12	G 3/8"	38	21,5	48,0	31,0	12	22	17	24	EVL-S-12-G 3/8"	58,13
S	630	14	G 1/2"	40	22,0	54,0	35,0	14	27	19	27	EVL-S-14-G 1/2"	69,97
S	400	16	G 1/2"	43	24,5	55,0	36,5	14	27	24	30	EVL-S-16-G 1/2"	107,35
S	400	20	G 3/4"	48	26,5	65,0	44,5	16	32	27	36	EVL-S-20-G 3/4"	132,99
S	400	25	G 1"	54	30,0	73,0	50,0	18	41	36	46	EVL-S-25-G 1"	214,69
S	400	30	G 1 1/4"	62	35,5	78,5	55,0	20	50	41	50	EVL-S-30-G 1 1/4"	265,62
S	250	38	G 1 1/2"	72	41,0	89,0	63,0	22	55	50	60	EVL-S-38-G 1 1/2"	374,68

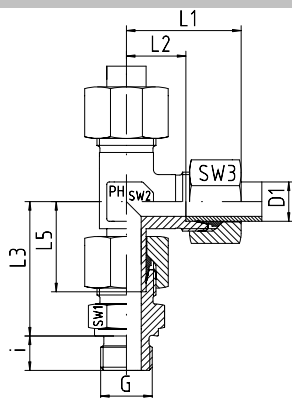

Einstellbare L-Verschraubungen
Einsteckausführung - Vormontiert
Einschraubgewinde: Whitworth-Rohrgewinde - Zylindrisch
Abdichtung durch Dichtkante Form B
Der Anschluss ist vormontiert. Die Fertigmontage erfolgt im
Stutzen mit ca. 1/2 Umdrehung der Überwurfmutter über den
Punkt des deutlich spürbaren Kraftanstieges.

Swivel Barrel Tees
Male Stud Type - Pre-Assembled
Thread: BSP - Parallel / Sealing by Sealing Shoulder Form B
The port is pre-assembled. Final assembly in appropriate
body with approx. 1/2 turn beyond the point of clearly
perceptible resistance.

Reihe Series	Druck Pressure PN	Rohr A.D. Tube O.D. D1	Gewinde Thread G	Ca. Maße Approx. Dimensions								Bestellzeichen Order-Code SC	Brutto-Preis Gross-Price Euro (€)
				L1	L2	L3	L5	i	SW1	SW2	SW3		
L	315	6	G 1/8"	27	12,0	34,5	26,0	8	14	12	14	EVL-L-06-G 1/8"-SC	34,70
L	315	8	G 1/4"	29	14,0	37,5	27,5	12	19	12	17	EVL-L-08-G 1/4"-SC	39,27
L	315	10	G 1/4"	30	15,0	40,0	29,0	12	19	14	19	EVL-L-10-G 1/4"-SC	43,82
L	315	12	G 3/8"	32	17,0	42,0	29,5	12	22	17	22	EVL-L-12-G 3/8"-SC	51,73
L	315	15	G 1/2"	36	21,0	46,5	32,5	14	27	19	27	EVL-L-15-G 1/2"-SC	70,90
L	315	18	G 1/2"	40	23,5	50,0	35,5	14	27	24	32	EVL-L-18-G 1/2"-SC	110,22
L	160	22	G 3/4"	44	27,5	55,0	38,5	16	32	27	36	EVL-L-22-G 3/4"-SC	120,71
L	160	28	G 1"	47	30,5	61,0	43,5	18	41	36	41	EVL-L-28-G 1"-SC	204,26
L	160	35	G 1 1/4"	56	34,5	71,5	54,0	20	50	41	50	EVL-L-35-G 1 1/4"-SC	296,82
L	160	42	G 1 1/2"	63	40,0	75,0	56,0	22	55	50	60	EVL-L-42-G 1 1/2"-SC	389,46

Reihe Series	Druck Pressure PN	Rohr A.D. Tube O.D. D1	Gewinde Thread G	Ca. Maße Approx. Dimensions								Bestellzeichen Order-Code SC	Brutto-Preis Gross-Price Euro (€)
				L1	L2	L3	L5	i	SW1	SW2	SW3		
S	630	6	G 1/4"	31	16,0	40,0	27,0	12	19	12	17	EVL-S-06-G 1/4"-SC	37,55
S	630	8	G 1/4"	32	17,0	42,5	27,5	12	19	14	19	EVL-S-08-G 1/4"-SC	42,15
S	630	10	G 3/8"	34	17,5	45,0	30,0	12	22	17	22	EVL-S-10-G 3/8"-SC	54,29
S	630	12	G 3/8"	38	21,5	48,0	31,0	12	22	17	24	EVL-S-12-G 3/8"-SC	60,65
S	630	14	G 1/2"	40	22,0	54,0	35,0	14	27	19	27	EVL-S-14-G 1/2"-SC	74,65
S	400	16	G 1/2"	43	24,5	55,0	36,5	14	27	24	30	EVL-S-16-G 1/2"-SC	112,03
S	400	20	G 3/4"	48	26,5	65,0	44,5	16	32	27	36	EVL-S-20-G 3/4"-SC	138,63
S	400	25	G 1"	54	30,0	73,0	50,0	18	41	36	46	EVL-S-25-G 1"-SC	223,69
S	400	30	G 1 1/4"	62	35,5	78,5	55,0	20	50	41	50	EVL-S-30-G 1 1/4"-SC	278,10
S	250	38	G 1 1/2"	72	41,0	89,0	63,0	22	55	50	60	EVL-S-38-G 1 1/2"-SC	391,60



Einstellbare L-Verschraubungen

Einsteckausführung - Vormontiert
Einschraubgewinde: Whitworth-Rohrgewinde - Zylindrisch
Abdichtung durch Dichtkante Form B
Der Anschluss ist vormontiert. Die Fertigmontage erfolgt im Stutzen mit ca. 1/2 Umdrehung der Überwurfmutter über den Punkt des deutlich spürbaren Kraftanstieges.

Swivel Barrel Tees

Male Stud Type - Pre-Assembled
Thread: BSP - Parallel / Sealing by Sealing Shoulder Form B
The port is pre-assembled. Final assembly in appropriate body with approx. 1/2 turn beyond the point of clearly perceptible resistance.

Reihe Series	Druck Pressure PN	Rohr A.D. Tube O.D. D1	Gewinde Thread G	Ca. Maße Approx. Dimensions						Bestellzeichen Order-Code OMD	Brutto-Preis Gross-Price Euro (€)
L	315	6	G 1/8"							EVL-L-06-G 1/8"-OMD	29,12
L	315	8	G 1/4"							EVL-L-08-G 1/4"-OMD	32,35
L	315	10	G 1/4"							EVL-L-10-G 1/4"-OMD	35,78
L	315	12	G 3/8"							EVL-L-12-G 3/8"-OMD	42,27
L	315	15	G 1/2"							EVL-L-15-G 1/2"-OMD	57,38
L	315	18	G 1/2"							EVL-L-18-G 1/2"-OMD	88,06
L	160	22	G 3/4"							EVL-L-22-G 3/4"-OMD	94,81
L	160	28	G 1"							EVL-L-28-G 1"-OMD	168,56
L	160	35	G 1 1/4"							EVL-L-35-G 1 1/4"-OMD	243,44
L	160	42	G 1 1/2"							EVL-L-42-G 1 1/2"-OMD	321,64

Reihe Series	Druck Pressure PN	Rohr A.D. Tube O.D. D1	Gewinde Thread G	Ca. Maße Approx. Dimensions						Bestellzeichen Order-Code OMD	Brutto-Preis Gross-Price Euro (€)
S	630	6	G 1/4"							EVL-S-06-G 1/4"-OMD	30,65
S	630	8	G 1/4"							EVL-S-08-G 1/4"-OMD	34,43
S	630	10	G 3/8"							EVL-S-10-G 3/8"-OMD	44,73
S	630	12	G 3/8"							EVL-S-12-G 3/8"-OMD	49,23
S	630	14	G 1/2"							EVL-S-14-G 1/2"-OMD	58,97
S	400	16	G 1/2"							EVL-S-16-G 1/2"-OMD	90,93
S	400	20	G 3/4"							EVL-S-20-G 3/4"-OMD	111,83
S	400	25	G 1"							EVL-S-25-G 1"-OMD	177,45
S	400	30	G 1 1/4"							EVL-S-30-G 1 1/4"-OMD	218,74
S	250	38	G 1 1/2"							EVL-S-38-G 1 1/2"-OMD	311,40

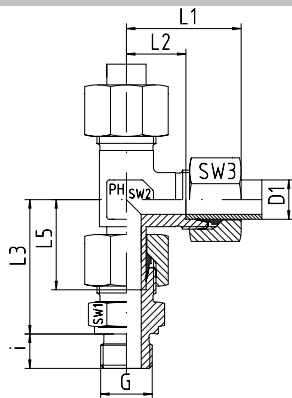

Einstellbare L-Verschraubungen
Einsteckausführung - Vormontiert
Einschraubgewinde: Metrisches Feingewinde - Zylindrisch
Abdichtung durch Dichtkante Form B
Der Anschluss ist vormontiert. Die Fertigmontage erfolgt im
Stutzen mit ca. 1/2 Umdrehung der Überwurfmutter über den
Punkt des deutlich spürbaren Kraftanstieges.

Swivel Barrel Tees
Male Stud Type - Pre-Assembled
Thread: Metric - Parallel / Sealing by Sealing Shoulder Form B
The port is pre-assembled. Final assembly in appropriate
body with approx. 1/2 turn beyond the point of clearly
perceptible resistance.

Reihe Series	Druck Pressure PN	Rohr A.D. Tube O.D. D1	Gewinde Thread G	Ca. Maße Approx. Dimensions								Bestellzeichen Order-Code Standard	Brutto-Preis Gross-Price Euro (€)
				L1	L2	L3	L5	i	SW1	SW2	SW3		
L	315	6	M 10 x 1	27	12,0	34,5	26,0	8	14	12	14	EVL-L-06-M 10x1	33,74
L	315	8	M 12 x 1,5	29	14,0	37,5	27,5	12	17	12	17	EVL-L-08-M 12x1,5	38,36
L	315	10	M 14 x 1,5	30	15,0	40,0	29,0	12	19	14	19	EVL-L-10-M 14x1,5	42,45
L	315	12	M 16 x 1,5	32	17,0	42,0	29,5	12	22	17	22	EVL-L-12-M 16x1,5	50,79
L	315	15	M 18 x 1,5	36	21,0	46,0	32,5	12	24	19	27	EVL-L-15-M 18x1,5	67,07
L	315	18	M 22 x 1,5	40	23,5	50,0	35,5	14	27	24	32	EVL-L-18-M 22x1,5	106,63
L	160	22	M 26 x 1,5	44	27,5	55,0	38,5	16	32	27	36	EVL-L-22-M 26x1,5	116,60
L	160	28	M 33 x 2	47	30,5	61,0	43,5	18	41	36	41	EVL-L-28-M 33x2	199,64
L	160	35	M 42 x 2	56	34,5	71,5	54,0	20	50	41	50	EVL-L-35-M 42x2	285,66
L	160	42	M 48 x 2	63	40,0	75,0	56,0	22	55	50	60	EVL-L-42-M 48x2	376,50

Reihe Series	Druck Pressure PN	Rohr A.D. Tube O.D. D1	Gewinde Thread G	Ca. Maße Approx. Dimensions								Bestellzeichen Order-Code Standard	Brutto-Preis Gross-Price Euro (€)
				L1	L2	L3	L5	i	SW1	SW2	SW3		
S	630	6	M 12 x 1,5	31	16,0	40,0	27,0	12	17	12	17	EVL-S-06-M 12x1,5	38,68
S	630	8	M 14 x 1,5	32	17,0	42,5	27,5	12	19	14	19	EVL-S-08-M 14x1,5	43,56
S	630	10	M 16 x 1,5	34	17,5	45,0	30,0	12	22	17	22	EVL-S-10-M 16x1,5	54,02
S	630	12	M 18 x 1,5	38	21,5	48,0	31,0	12	24	17	24	EVL-S-12-M 18x1,5	59,57
S	630	14	M 20 x 1,5	40	22,0	54,0	35,0	14	27	19	27	EVL-S-14-M 20x1,5	69,89
S	400	16	M 22 x 1,5	43	24,5	55,0	36,5	14	27	24	30	EVL-S-16-M 22x1,5	107,35
S	400	20	M 27 x 2	48	26,5	65,0	44,5	16	32	27	36	EVL-S-20-M 27x2	133,24
S	400	25	M 33 x 2	54	30,0	73,0	50,0	18	41	36	46	EVL-S-25-M 33x2	214,92
S	400	30	M 42 x 2	62	35,5	78,5	55,0	20	50	41	50	EVL-S-30-M 42x2	264,16
S	250	38	M 48 x 2	72	41,0	89,0	63,0	22	55	50	60	EVL-S-38-M 48x2	375,19

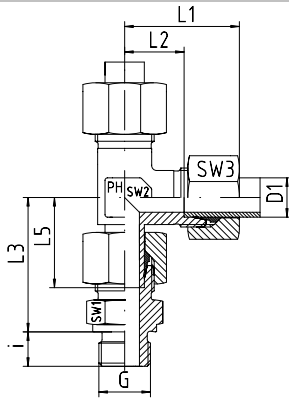

Einstellbare L-Verschraubungen
Einsteckausführung - Vormontiert
Einschraubgewinde: Metrisches Feingewinde - Zylindrisch
Abdichtung durch Dichtkante Form B
Der Anschluss ist vormontiert. Die Fertigmontage erfolgt im
Stutzen mit ca. 1/2 Umdrehung der Überwurfmutter über den
Punkt des deutlich spürbaren Kraftanstieges.

Swivel Barrel Tees
Male Stud Type - Pre-Assembled
Thread: Metric - Parallel / Sealing by Sealing Shoulder Form B
The port is pre-assembled. Final assembly in appropriate
body with approx. 1/2 turn beyond the point of clearly
perceptible resistance.

Reihe Series	Druck Pressure PN	Rohr A.D. Tube O.D. D1	Gewinde Thread G	Ca. Maße Approx. Dimensions								Bestellzeichen Order-Code SC	Brutto-Preis Gross-Price Euro (€)
				L1	L2	L3	L5	i	SW1	SW2	SW3		
L	315	6	M 10 x 1	27	12,0	34,5	26,0	8	14	12	14	EVL-L-06-M 10x1-SC	34,70
L	315	8	M 12 x 1,5	29	14,0	37,5	27,5	12	17	12	17	EVL-L-08-M 12x1,5-SC	39,68
L	315	10	M 14 x 1,5	30	15,0	40,0	29,0	12	19	14	19	EVL-L-10-M 14x1,5-SC	43,77
L	315	12	M 16 x 1,5	32	17,0	42,0	29,5	12	22	17	22	EVL-L-12-M 16x1,5-SC	52,47
L	315	15	M 18 x 1,5	36	21,0	46,0	32,5	12	24	19	27	EVL-L-15-M 18x1,5-SC	70,31
L	315	18	M 22 x 1,5	40	23,5	50,0	35,5	14	27	24	32	EVL-L-18-M 22x1,5-SC	111,55
L	160	22	M 26 x 1,5	44	27,5	55,0	38,5	16	32	27	36	EVL-L-22-M 26x1,5-SC	121,88
L	160	28	M 33 x 2	47	30,5	61,0	43,5	18	41	36	41	EVL-L-28-M 33x2-SC	205,64
L	160	35	M 42 x 2	56	34,5	71,5	54,0	20	50	41	50	EVL-L-35-M 42x2-SC	296,82
L	160	42	M 48 x 2	63	40,0	75,0	56,0	22	55	50	60	EVL-L-42-M 48x2-SC	389,46

Reihe Series	Druck Pressure PN	Rohr A.D. Tube O.D. D1	Gewinde Thread G	Ca. Maße Approx. Dimensions								Bestellzeichen Order-Code SC	Brutto-Preis Gross-Price Euro (€)
				L1	L2	L3	L5	i	SW1	SW2	SW3		
S	630	6	M 12 x 1,5	31	16,0	40,0	27,0	12	17	12	17	EVL-S-06-M 12x1,5-SC	40,00
S	630	8	M 14 x 1,5	32	17,0	42,5	27,5	12	19	14	19	EVL-S-08-M 14x1,5-SC	44,88
S	630	10	M 16 x 1,5	34	17,5	45,0	30,0	12	22	17	22	EVL-S-10-M 16x1,5-SC	55,70
S	630	12	M 18 x 1,5	38	21,5	48,0	31,0	12	24	17	24	EVL-S-12-M 18x1,5-SC	62,09
S	630	14	M 20 x 1,5	40	22,0	54,0	35,0	14	27	19	27	EVL-S-14-M 20x1,5-SC	74,57
S	400	16	M 22 x 1,5	43	24,5	55,0	36,5	14	27	24	30	EVL-S-16-M 22x1,5-SC	112,03
S	400	20	M 27 x 2	48	26,5	65,0	44,5	16	32	27	36	EVL-S-20-M 27x2-SC	138,88
S	400	25	M 33 x 2	54	30,0	73,0	50,0	18	41	36	46	EVL-S-25-M 33x2-SC	223,92
S	400	30	M 42 x 2	62	35,5	78,5	55,0	20	50	41	50	EVL-S-30-M 42x2-SC	276,64
S	250	38	M 48 x 2	72	41,0	89,0	63,0	22	55	50	60	EVL-S-38-M 48x2-SC	392,11



Einstellbare L-Verschraubungen
Einsteckausführung - Vormontiert
Einschraubgewinde: Metrisches Feingewinde - Zylindrisch
Abdichtung durch Dichtkante Form B
Der Anschluss ist vormontiert. Die Fertigmontage erfolgt im Stutzen mit ca. 1/2 Umdrehung der Überwurfmutter über den Punkt des deutlich spürbaren Kraftanstieges.

Swivel Barrel Tees
Male Stud Type - Pre-Assembled
Thread: Metric - Parallel / Sealing by Sealing Shoulder Form B
The port is pre-assembled. Final assembly in appropriate body with approx. 1/2 turn beyond the point of clearly perceptible resistance.

Reihe Series	Druck Pressure PN	Rohr A.D. Tube O.D. D1	Gewinde Thread G	Ca. Maße Approx. Dimensions						Bestellzeichen Order-Code OMD	Brutto-Preis Gross-Price Euro (€)
L	315	6	M 10 x 1							EVL-L-06-M 10x1-OMD	29,12
L	315	8	M 12 x 1,5							EVL-L-08-M 12x1,5-OMD	32,76
L	315	10	M 14 x 1,5							EVL-L-10-M 14x1,5-OMD	35,73
L	315	12	M 16 x 1,5							EVL-L-12-M 16x1,5-OMD	43,01
L	315	15	M 18 x 1,5							EVL-L-15-M 18x1,5-OMD	56,79
L	315	18	M 22 x 1,5							EVL-L-18-M 22x1,5-OMD	89,39
L	160	22	M 26 x 1,5							EVL-L-22-M 26x1,5-OMD	95,98
L	160	28	M 33 x 2							EVL-L-28-M 33x2-OMD	169,94
L	160	35	M 42 x 2							EVL-L-35-M 42x2-OMD	243,44
L	160	42	M 48 x 2							EVL-L-42-M 48x2-OMD	321,64

Reihe Series	Druck Pressure PN	Rohr A.D. Tube O.D. D1	Gewinde Thread G	Ca. Maße Approx. Dimensions						Bestellzeichen Order-Code OMD	Brutto-Preis Gross-Price Euro (€)
S	630	6	M 12 x 1,5							EVL-S-06-M 12x1,5-OMD	33,10
S	630	8	M 14 x 1,5							EVL-S-08-M 14x1,5-OMD	37,16
S	630	10	M 16 x 1,5							EVL-S-10-M 16x1,5-OMD	46,14
S	630	12	M 18 x 1,5							EVL-S-12-M 18x1,5-OMD	50,67
S	630	14	M 20 x 1,5							EVL-S-14-M 20x1,5-OMD	58,89
S	400	16	M 22 x 1,5							EVL-S-16-M 22x1,5-OMD	90,93
S	400	20	M 27 x 2							EVL-S-20-M 27x2-OMD	112,08
S	400	25	M 33 x 2							EVL-S-25-M 33x2-OMD	177,68
S	400	30	M 42 x 2							EVL-S-30-M 42x2-OMD	217,28
S	250	38	M 48 x 2							EVL-S-38-M 48x2-OMD	311,91

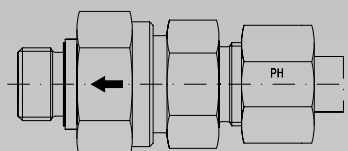

RZ
Strömung zum Einschraubzapfen
Flow towards Screwed Plug

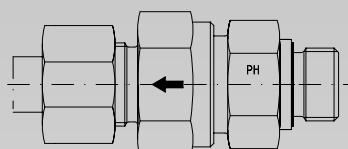

RV
Strömung vom Einschraubzapfen
Flow from Screwed Plug

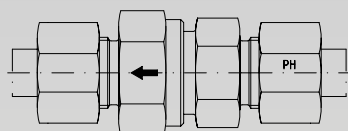

RD

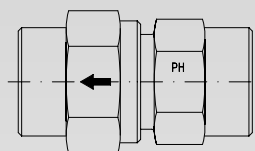

RD-I

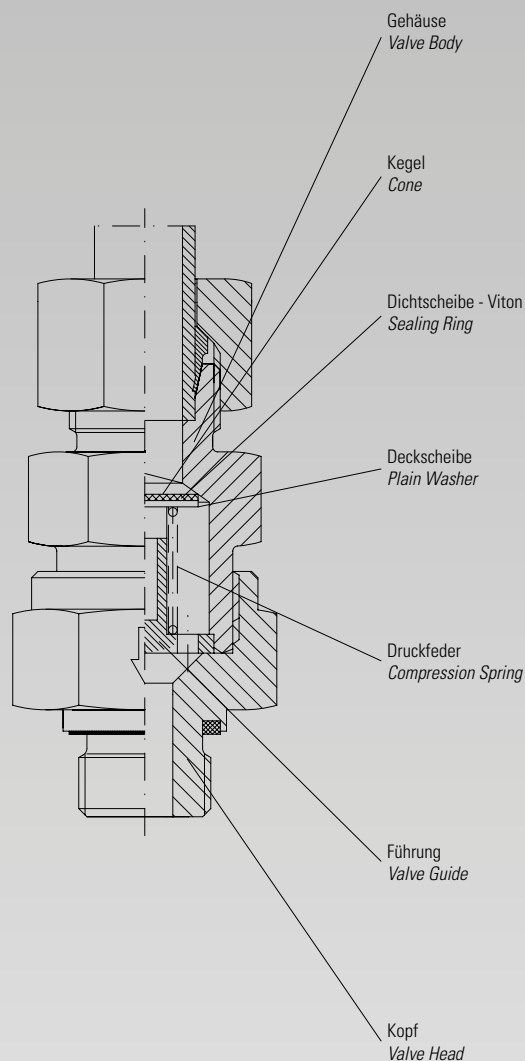

Wichtige Merkmale

Unsere Kegel-Rückschlagventile werden serienmäßig mit einem Öffnungsdruck von 1 bar geliefert.

Abnormale Öffnungsdrücke von 0,2; 0,5; 2 und 3 bar sind auf Wunsch lieferbar, und werden dann dem Bestellzeichen nachgestellt. (z.B. RD-L-12-0,5 bar)

Der Hub ist begrenzt. Der Durchflussquerschnitt wird nicht eingengt. Durchflussgeschwindigkeit max. 4-5 m/s. Die Ventile sind mit Strömungsrichtung und Öffnungsdruck gekennzeichnet.

Werkstoff: 1.4571

Andere Werkstoffe auf Anfrage!

Dichtungen aus Viton (-20°C bis +200°C)

Toleranz des Öffnungsdruckes = ± 20 %

Verwendung für Hydraulikflüssigkeiten

Um die Eignung der Ventile bei anderen Bedingungen zu gewährleisten, bitten wir um Angabe des Mediums, eventuell auch Konzentration, max. Betriebsdruck inkl. Druckspitzen, Temperatur und Häufigkeit der Ventilbetätigung.

Important Data

Our non-return valves are supplied with standard valve lift pressure 1 bar. Valve lift alternative pressures are 0,2; 0,5; 2 and 3 bar, supplied on request. (e.g. RD-L-12-0,5 bar)

The valve stroke is limited. The flow is 4-5 m/s. All valves are identified with flow direction and valve lift pressure.

Material: 1.4571

Other materials on request!

Viton Seals Temperature Range (-20°C to +200°C)

Opening pressure tolerance = ± 20 %

Application for Hydraulic Fluids

In order to guarantee the suitability of the valves for other applications, we request the description of the medium, possibly also the concentration, max. working pressure including peak pressure, temperature and frequency of the valve operation.

TECHNISCHE DATEN / DURCHFLUSSWIDERSTÄNDE - RÜCKSCHLAGVENTILE

TECHNICAL DATA / PRESSURE DROP -
NON-RETURN-VALVES



EDELSTAHL / STAINLESS STEEL
VERBINDUNGSTECHNIK
FLUID CONNECTORS

Gemessen mit Hydrauliköl
1 cm² / s = 100 cSt
1 bar Öffnungsdruck

*Tested with hydraulic oil
1 cm² / s = 100 cSt
1 bar opening pressure*

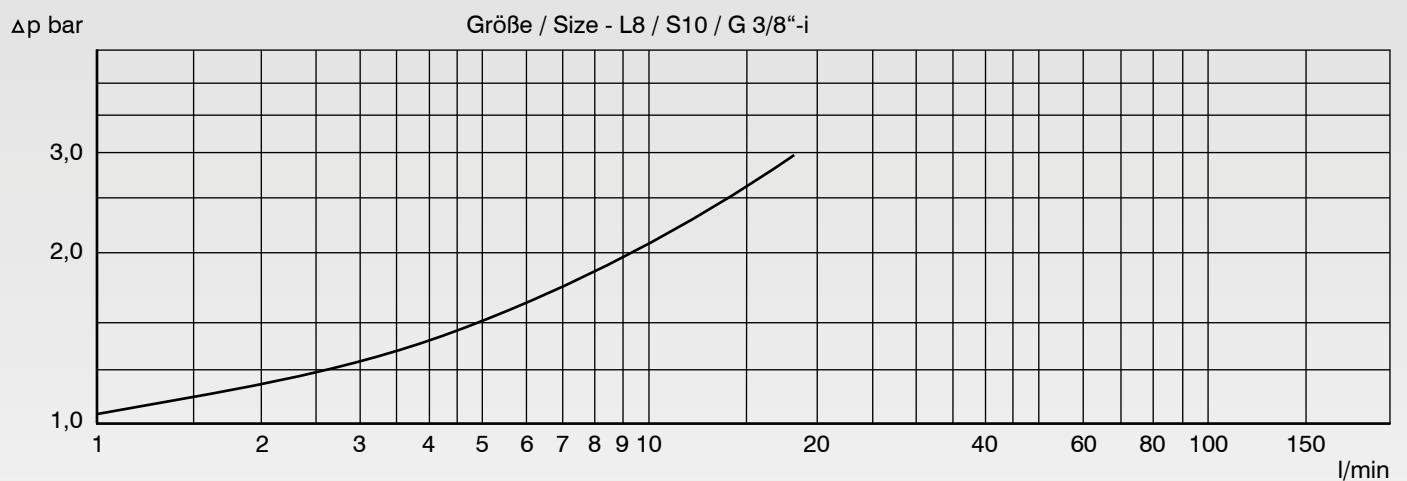
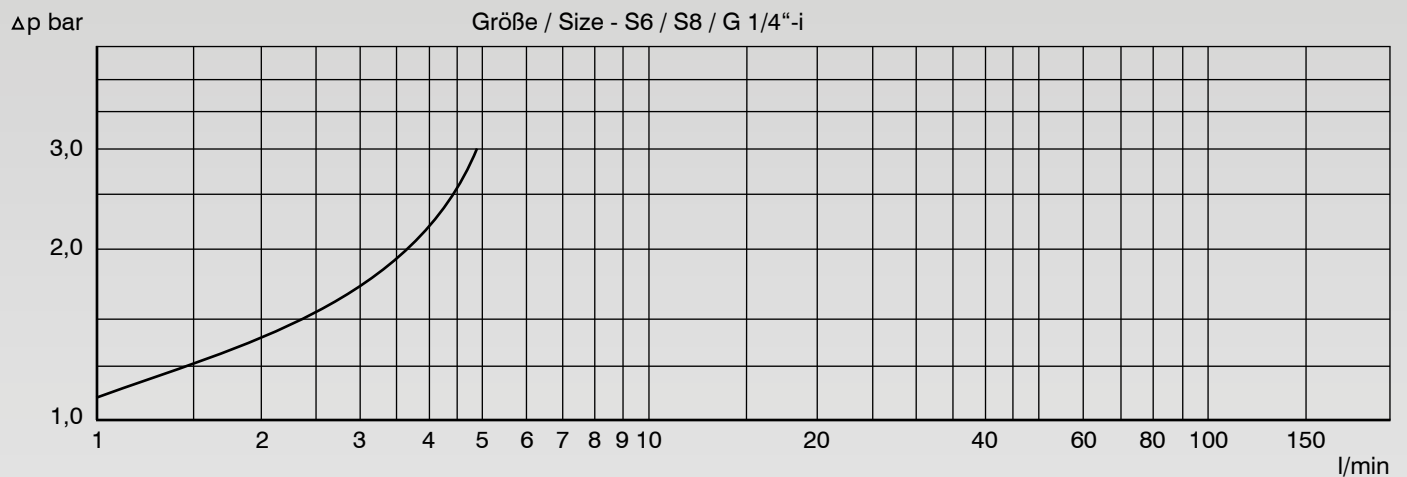
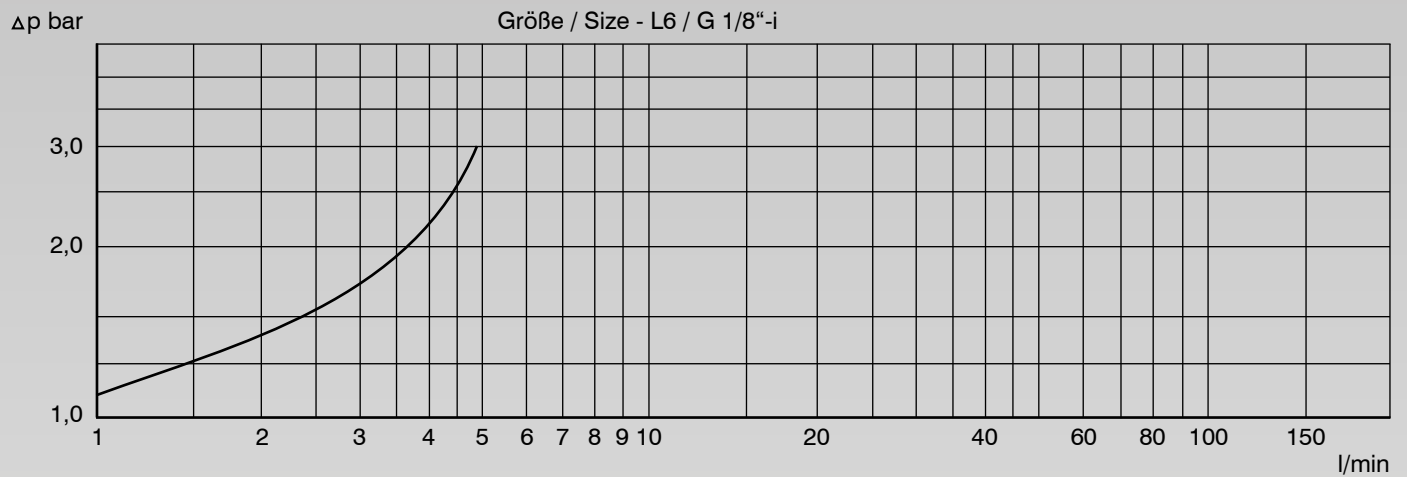



Gemessen mit Hydrauliköl
1 cm² / s = 100 cSt
1 bar Öffnungsdruck

Tested with hydraulic oil
1 cm² / s = 100 cSt
1 bar opening pressure

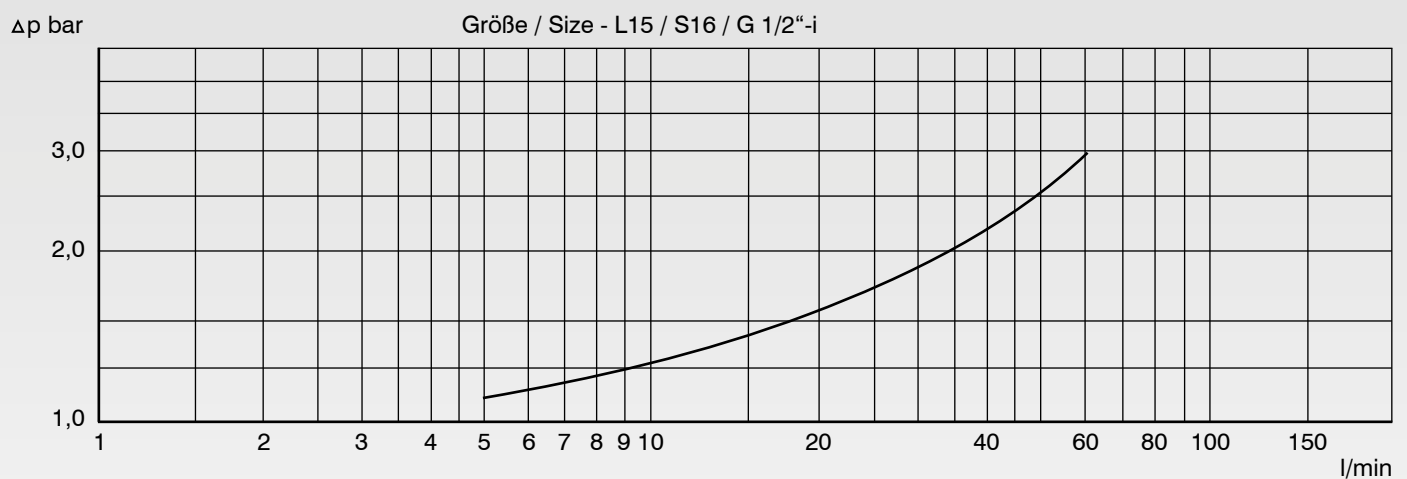
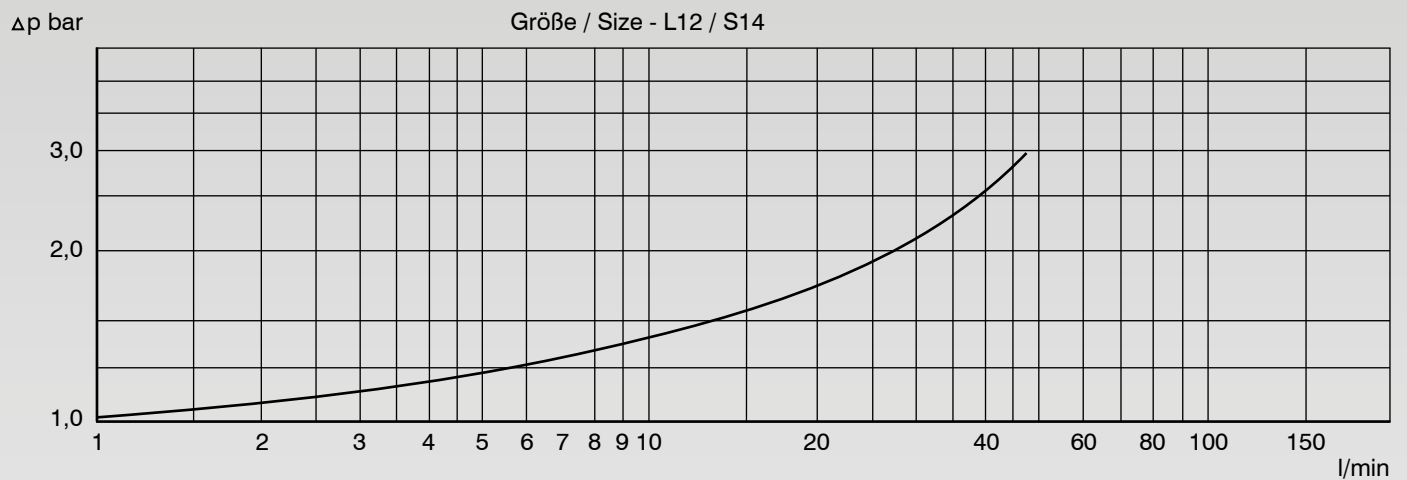
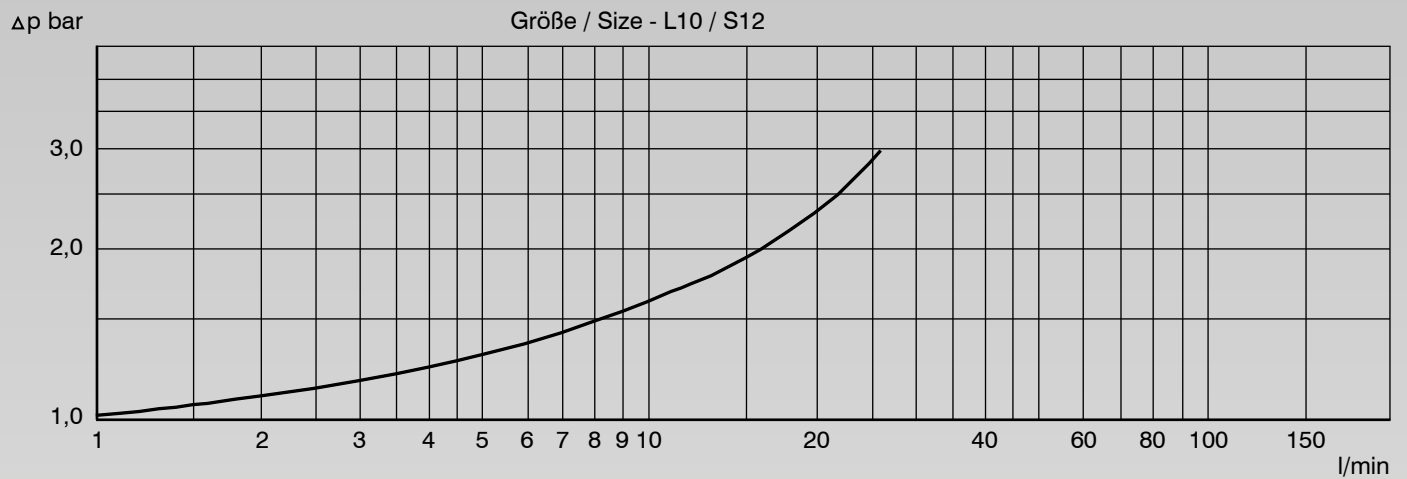

TECHNISCHE DATEN / DURCHFLUSSWIDERSTÄNDE - RÜCKSCHLAGVENTILE

TECHNICAL DATA / PRESSURE DROP -
NON-RETURN-VALVES



EDELSTAHL / STAINLESS STEEL
VERBINDUNGSTECHNIK
FLUID CONNECTORS

Gemessen mit Hydrauliköl
1 cm² / s = 100 cSt
1 bar Öffnungsdruck

Tested with hydraulic oil
1 cm² / s = 100 cSt
1 bar opening pressure

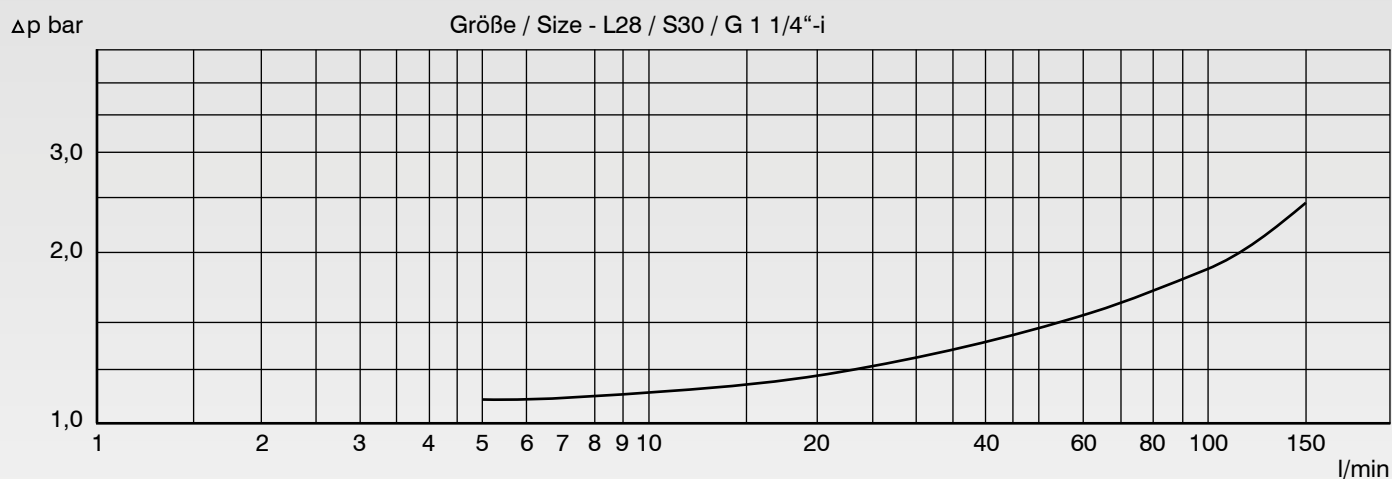
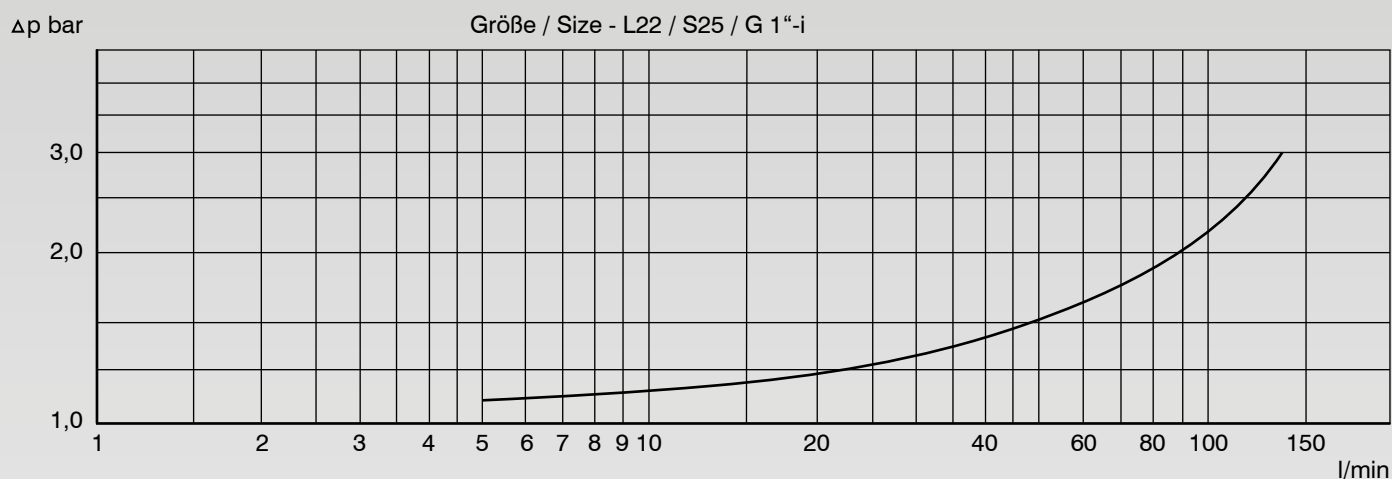
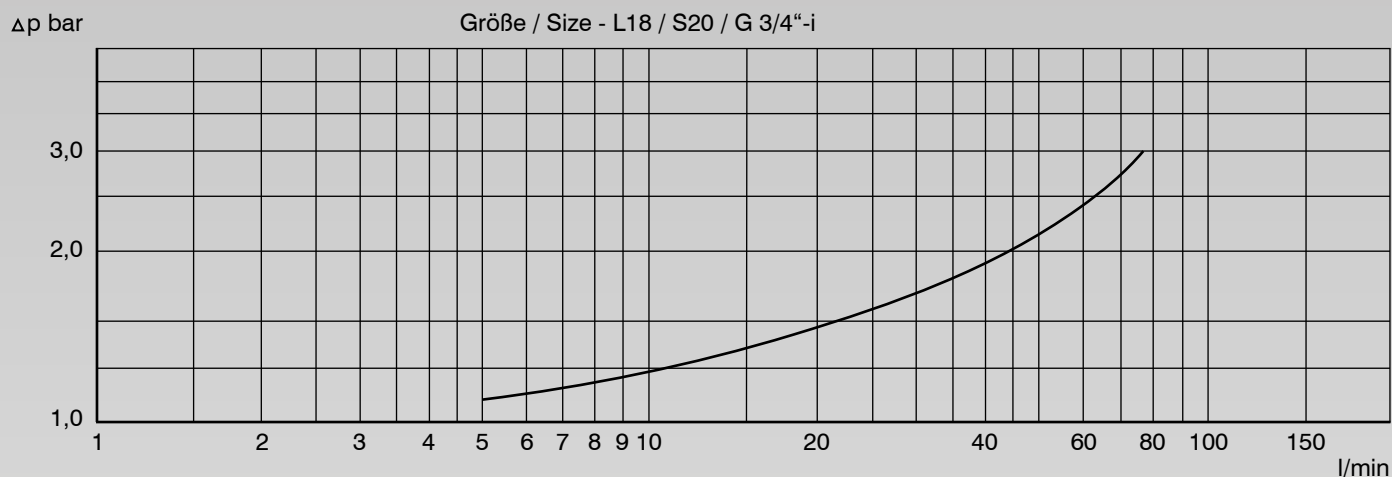



Gemessen mit Hydrauliköl
1 cm² / s = 100 cSt
1 bar Öffnungsdruck

Tested with hydraulic oil
1 cm² / s = 100 cSt
1 bar opening pressure

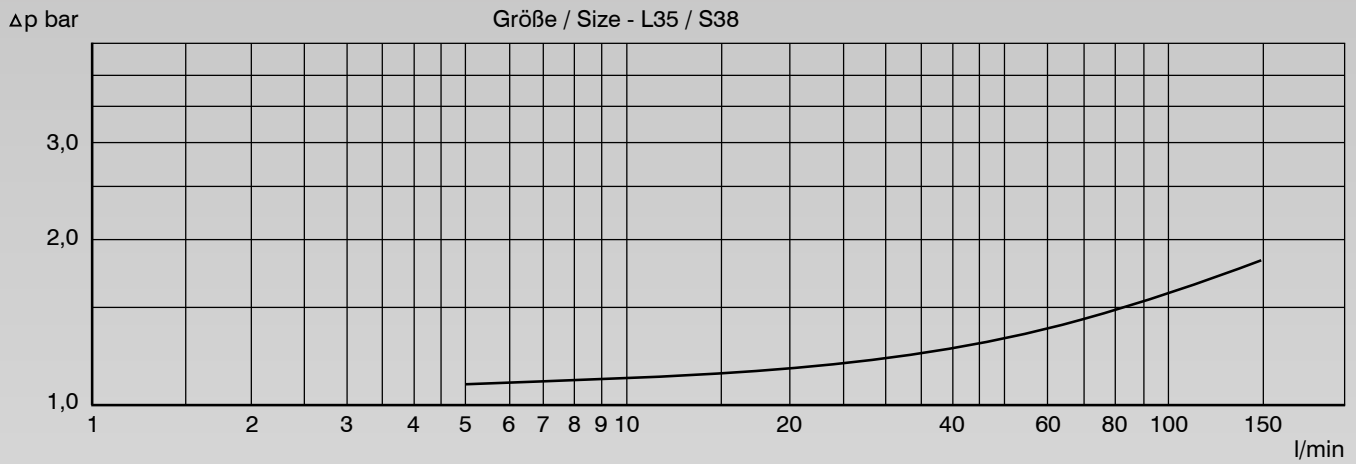

TECHNISCHE DATEN / DURCHFLUSSWIDERSTÄNDE - RÜCKSCHLAGVENTILE

TECHNICAL DATA / PRESSURE DROP -
NON-RETURN-VALVES



EDELSTAHL / STAINLESS STEEL
VERBINDUNGSTECHNIK
FLUID CONNECTORS

Gemessen mit Hydrauliköl
1 cm² / s = 100 cSt
1 bar Öffnungsdruck

*Tested with hydraulic oil
1 cm² / s = 100 cSt
1 bar opening pressure*

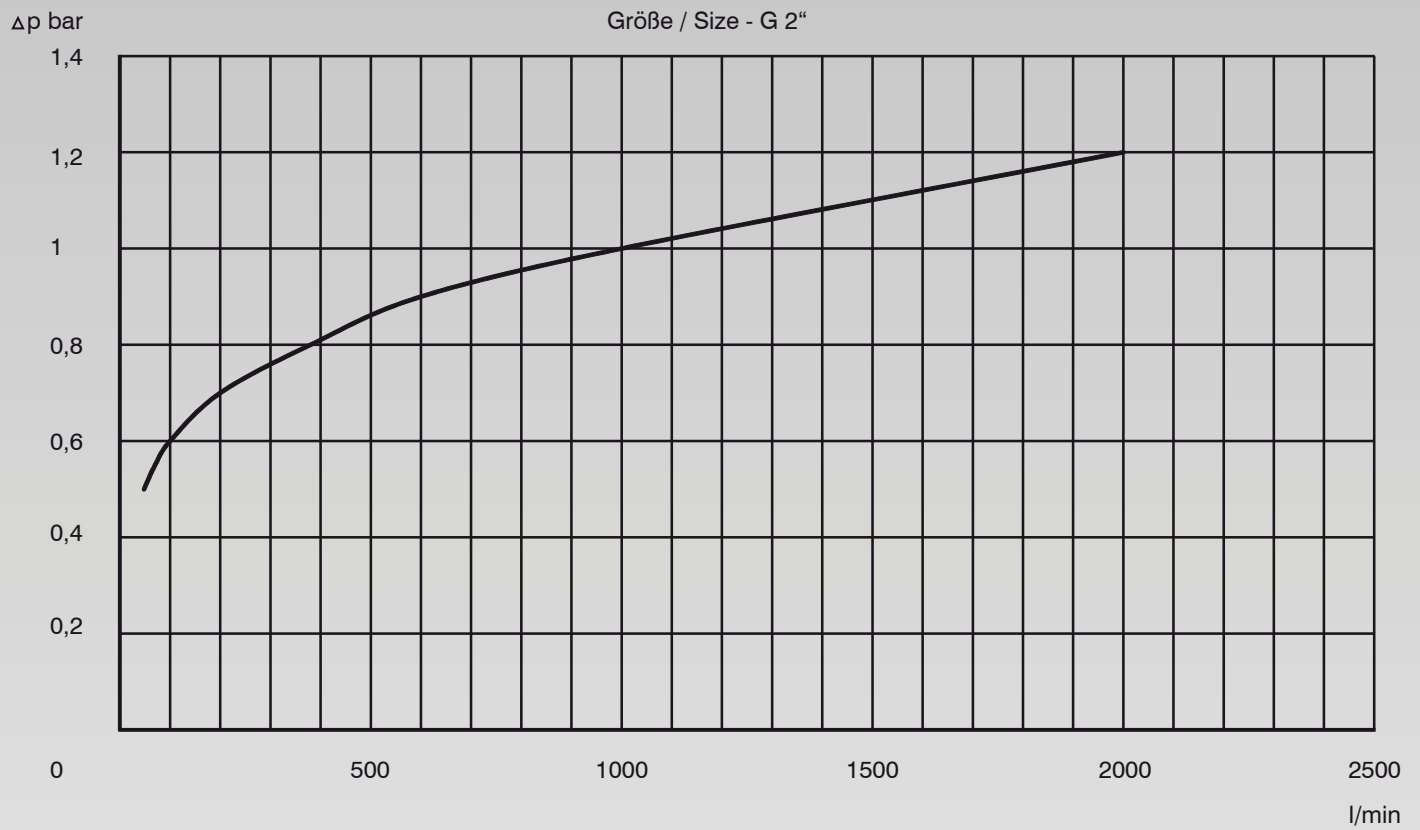

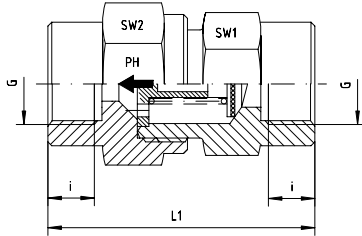

Beidseitiges Innengewinde
Whitworth-Rohrgewinde - Zylindrisch
NPT-Gewinde

Both Sides Inside Thread
BSP - Parallel
NPT-Thread

Druck Pressure PB	Gewinde Thread G	Ca. Maße Approx. Dimensions				Bestellzeichen Order-Code	Brutto-Preis Gross-Price Euro (€)
		L1	i	SW1	SW2		
400	G 1/8" BSP	42,5	8,0	17	17	RD-I-G 1/8"	65,96
400	G 1/4" BSP	54,0	12,0	19	19	RD-I-G 1/4"	65,96
400	G 3/8" BSP	60,0	12,0	24	27	RD-I-G 3/8"	74,14
400	G 1/2" BSP	71,0	15,0	32	36	RD-I-G 1/2"	94,59
400	G 3/4" BSP	84,0	16,5	41	46	RD-I-G 3/4"	152,37
400	G 1" BSP	94,5	19,0	46	50	RD-I-G 1"	165,66
250	G 1 1/4" BSP	110,0	21,5	55	60	RD-I-G 1 1/4"	319,00
250	G 1 1/2" BSP	114,5	22,0	65	70	RD-I-G 1 1/2"	489,00
250	G 2" BSP	120,0	26,0	75	75	RD-I-G 2"	812,00

nur 0,5 bar Öffnungsdruck / only 0,5 bar valve lift pressure

Druck Pressure PB	Gewinde Thread G	Ca. Maße Approx. Dimensions				Bestellzeichen Order-Code	Brutto-Preis Gross-Price Euro (€)
		L1	i	SW1	SW2		
400	1/8" NPT	42,5	11,6	17	17	RD-I-NPT-1/8"	79,15
400	1/4" NPT	57,5	16,4	19	19	RD-I-NPT-1/4"	79,15
400	3/8" NPT	63,5	17,4	24	27	RD-I-NPT-3/8"	88,97
400	1/2" NPT	78,0	22,6	32	36	RD-I-NPT-1/2"	113,50
400	3/4" NPT	84,5	23,1	41	46	RD-I-NPT-3/4"	182,85
400	1" NPT	101,0	27,8	46	50	RD-I-NPT-1"	198,80
250	1 1/4" NPT	110,0	28,3	55	60	RD-I-NPT-1 1/4"	382,80
250	1 1/2" NPT	117,5	28,3	65	70	RD-I-NPT-1 1/2"	586,80
250	2" NPT	120,0		75	75	RD-I-NPT-2"	812,00

nur 0,5 bar Öffnungsdruck / only 0,5 bar valve lift pressure

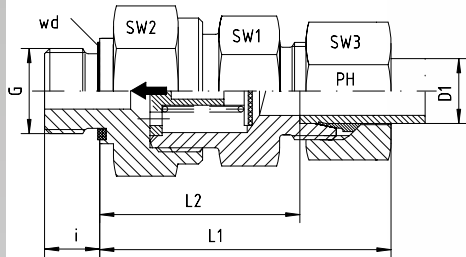

Einschraubgewinde G: Metrisches Feingewinde -
Zylindrisch
Einschraubzapfen mit Weichdichtung - Viton
Strömung zum Einschraubzapfen

*Thread G: Metric - Parallel
Screwed Plug with Captive Seal - Viton
Flow towards Screwed Plug*

Reihe Series	Druck Pressure PB	Rohr A.D. Tube O.D. D1	Gewinde Thread G	Ca. Maße Approx. Dimensions						Bestellzeichen Order-Code Standard	Brutto-Preis Gross-Price Euro (€)
				L1	L2	i	SW1	SW2	SW3		
L	250	6	M 10 x 1	41	26,5	8	17	17	14	RZ-L-06-M 10x1-wd	53,69
L	250	8	M 12 x 1,5	43	28,5	12	19	17	17	RZ-L-08-M 12x1,5-wd	58,80
L	250	10	M 14 x 1,5	53	38,5	12	24	22	19	RZ-L-10-M 14x1,5-wd	69,03
L	250	12	M 16 x 1,5	55	40,5	12	30	27	22	RZ-L-12-M 16x1,5-wd	81,81
L	250	15	M 18 x 1,5	58	42,5	12	30	27	27	RZ-L-15-M 18x1,5-wd	92,03
L	160	18	M 22 x 1,5	64	48,0	14	36	36	32	RZ-L-18-M 22x1,5-wd	120,16
L	160	22	M 26 x 1,5	72	56,0	16	46	41	36	RZ-L-22-M 26x1,5-wd	171,80
L	100	28	M 33 x 2	81	64,0	18	55	50	41	RZ-L-28-M 33x2-wd	232,64
L	100	35	M 42 x 2	92	70,0	20	60	60	50	RZ-L-35-M 42x2-wd	334,90
L	100	42	M 48 x 2	104	71,5	22	70	65	60	RZ-L-42-M 48x2-wd	472,95

Reihe Series	Druck Pressure PB	Rohr A.D. Tube O.D. D1	Gewinde Thread G	Ca. Maße Approx. Dimensions						Bestellzeichen Order-Code Standard	Brutto-Preis Gross-Price Euro (€)
				L1	L2	i	SW1	SW2	SW3		
S	630	6	M 12 x 1,5	46	31,5	12	19	19	17	RZ-S-06-M 12x1,5-wd	58,80
S	630	8	M 14 x 1,5	46	31,5	12	22	19	19	RZ-S-08-M 14x1,5-wd	61,36
S	630	10	M 16 x 1,5	54	38,0	12	27	24	22	RZ-S-10-M 16x1,5-wd	71,58
S	630	12	M 18 x 1,5	57	41,0	12	30	27	24	RZ-S-12-M 18x1,5-wd	76,69
S	630	14	M 20 x 1,5	61	43,5	14	32	27	27	RZ-S-14-M 20x1,5-wd	86,92
S	400	16	M 22 x 1,5	64	46,0	14	36	32	30	RZ-S-16-M 22x1,5-wd	104,82
S	400	20	M 27 x 2	72	50,0	16	46	41	36	RZ-S-20-M 27x2-wd	166,17
S	400	25	M 33 x 2	79	54,5	18	50	46	46	RZ-S-25-M 33x2-wd	212,19
S	250	30	M 42 x 2	91	64,0	20	60	55	50	RZ-S-30-M 42x2-wd	306,78
S	250	38	M 48 x 2	102	71,5	22	70	65	60	RZ-S-38-M 48x2-wd	414,15

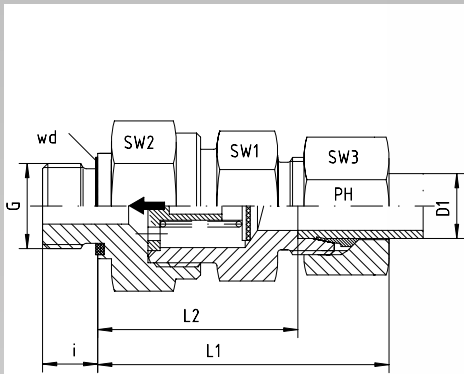

Einschraubgewinde G: Metrisches Feingewinde -
Zylindrisch
Einschraubzapfen mit Weichdichtung - Viton
Strömung zum Einschraubzapfen

*Thread G: Metric - Parallel
Screwed Plug with Captive Seal - Viton
Flow towards Screwed Plug*

Reihe Series	Druck Pressure PB	Rohr A.D. Tube O.D. D1	Gewinde Thread G	Ca. Maße Approx. Dimensions						Bestellzeichen Order-Code SC	Brutto-Preis Gross-Price Euro (€)
				L1	L2	i	SW1	SW2	SW3		
L	250	6	M 10 x 1	41	26,5	8	17	17	14	RZ-L-06-M 10x1-wd-SC	54,01
L	250	8	M 12 x 1,5	43	28,5	12	19	17	17	RZ-L-08-M 12x1,5-wd-SC	59,24
L	250	10	M 14 x 1,5	53	38,5	12	24	22	19	RZ-L-10-M 14x1,5-wd-SC	69,47
L	250	12	M 16 x 1,5	55	40,5	12	30	27	22	RZ-L-12-M 16x1,5-wd-SC	82,37
L	250	15	M 18 x 1,5	58	42,5	12	30	27	27	RZ-L-15-M 18x1,5-wd-SC	93,11
L	160	18	M 22 x 1,5	64	48,0	14	36	36	32	RZ-L-18-M 22x1,5-wd-SC	121,80
L	160	22	M 26 x 1,5	72	56,0	16	46	41	36	RZ-L-22-M 26x1,5-wd-SC	173,56
L	100	28	M 33 x 2	81	64,0	18	55	50	41	RZ-L-28-M 33x2-wd-SC	234,64
L	100	35	M 42 x 2	92	70,0	20	60	60	50	RZ-L-35-M 42x2-wd-SC	338,62
L	100	42	M 48 x 2	104	71,5	22	70	65	60	RZ-L-42-M 48x2-wd-SC	477,27

Reihe Series	Druck Pressure PB	Rohr A.D. Tube O.D. D1	Gewinde Thread G	Ca. Maße Approx. Dimensions						Bestellzeichen Order-Code SC	Brutto-Preis Gross-Price Euro (€)
				L1	L2	i	SW1	SW2	SW3		
S	630	6	M 12 x 1,5	46	31,5	12	19	19	17	RZ-S-06-M 12x1,5-wd-SC	59,24
S	630	8	M 14 x 1,5	46	31,5	12	22	19	19	RZ-S-08-M 14x1,5-wd-SC	61,80
S	630	10	M 16 x 1,5	54	38,0	12	27	24	22	RZ-S-10-M 16x1,5-wd-SC	72,14
S	630	12	M 18 x 1,5	57	41,0	12	30	27	24	RZ-S-12-M 18x1,5-wd-SC	77,53
S	630	14	M 20 x 1,5	61	43,5	14	32	27	27	RZ-S-14-M 20x1,5-wd-SC	88,48
S	400	16	M 22 x 1,5	64	46,0	14	36	32	30	RZ-S-16-M 22x1,5-wd-SC	106,38
S	400	20	M 27 x 2	72	50,0	16	46	41	36	RZ-S-20-M 27x2-wd-SC	168,05
S	400	25	M 33 x 2	79	54,5	18	50	46	46	RZ-S-25-M 33x2-wd-SC	215,19
S	250	30	M 42 x 2	91	64,0	20	60	55	50	RZ-S-30-M 42x2-wd-SC	310,94
S	250	38	M 48 x 2	102	71,5	22	70	65	60	RZ-S-38-M 48x2-wd-SC	419,79



Einschraubgewinde G: Metrisches Feingewinde -
Zylindrisch
Einerseits für DIN EN ISO 8434-1 Schneidring
Einschraubzapfen mit Weichdichtung - Viton
Strömung zum Einschraubzapfen

*Thread G: Metric - Parallel
On the one hand for DIN EN ISO 8434-1 Cutting Ring
Screwed Plug with Captive Seal - Viton
Flow towards Screwed Plug*

Reihe Series	Druck Pressure PB	Rohr A.D. Tube O.D. D1	Gewinde Thread G	Ca. Maße Approx. Dimensions						Bestellzeichen Order-Code OMD	Brutto-Preis Gross-Price Euro (€)
L	250	6	M 10 x 1							RZ-L-06-M 10x1-wd-OMD	51,38
L	250	8	M 12 x 1,5							RZ-L-08-M 12x1,5-wd-OMD	56,00
L	250	10	M 14 x 1,5							RZ-L-10-M 14x1,5-wd-OMD	65,67
L	250	12	M 16 x 1,5							RZ-L-12-M 16x1,5-wd-OMD	77,92
L	250	15	M 18 x 1,5							RZ-L-15-M 18x1,5-wd-OMD	86,89
L	160	18	M 22 x 1,5							RZ-L-18-M 22x1,5-wd-OMD	111,54
L	160	22	M 26 x 1,5							RZ-L-22-M 26x1,5-wd-OMD	161,49
L	100	28	M 33 x 2							RZ-L-28-M 33x2-wd-OMD	217,79
L	100	35	M 42 x 2							RZ-L-35-M 42x2-wd-OMD	313,79
L	100	42	M 48 x 2							RZ-L-42-M 48x2-wd-OMD	445,52

Reihe Series	Druck Pressure PB	Rohr A.D. Tube O.D. D1	Gewinde Thread G	Ca. Maße Approx. Dimensions						Bestellzeichen Order-Code OMD	Brutto-Preis Gross-Price Euro (€)
S	630	6	M 12 x 1,5							RZ-S-06-M 12x1,5-wd-OMD	56,01
S	630	8	M 14 x 1,5							RZ-S-08-M 14x1,5-wd-OMD	58,16
S	630	10	M 16 x 1,5							RZ-S-10-M 16x1,5-wd-OMD	67,64
S	630	12	M 18 x 1,5							RZ-S-12-M 18x1,5-wd-OMD	72,24
S	630	14	M 20 x 1,5							RZ-S-14-M 20x1,5-wd-OMD	81,42
S	400	16	M 22 x 1,5							RZ-S-16-M 22x1,5-wd-OMD	96,61
S	400	20	M 27 x 2							RZ-S-20-M 27x2-wd-OMD	155,59
S	400	25	M 33 x 2							RZ-S-25-M 33x2-wd-OMD	193,57
S	250	30	M 42 x 2							RZ-S-30-M 42x2-wd-OMD	283,34
S	250	38	M 48 x 2							RZ-S-38-M 48x2-wd-OMD	382,34

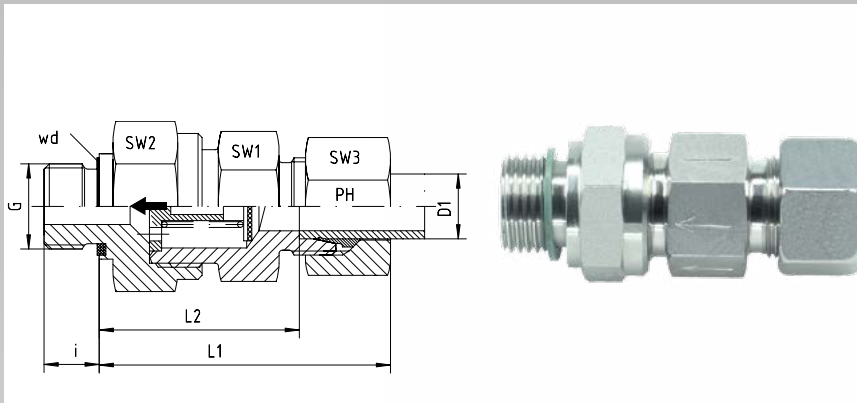

Einschraubgewinde G: Whitworth-Rohrgewinde -
Zylindrisch
Einschraubzapfen mit Weichdichtung - Viton
Strömung zum Einschraubzapfen

Thread G: BSP - Parallel
Screwed Plug with Captive Seal - Viton
Flow towards Screwed Plug

Reihe Series	Druck Pressure PB	Rohr A.D. Tube O.D. D1	Gewinde Thread G	Ca. Maße Approx. Dimensions						Bestellzeichen Order-Code Standard	Brutto-Preis Gross-Price Euro (€)
				L1	L2	i	SW1	SW2	SW3		
L	250	6	G 1/8"	41	26,5	8	17	17	14	RZ-L-06-G 1/8"-wd	53,69
L	250	8	G 1/4"	43	28,5	12	19	17	17	RZ-L-08-G 1/4"-wd	58,80
L	250	10	G 1/4"	53	38,5	12	24	22	19	RZ-L-10-G 1/4"-wd	69,03
L	250	12	G 3/8"	55	40,5	12	30	27	22	RZ-L-12-G 3/8"-wd	81,81
L	250	15	G 1/2"	58	42,5	14	30	27	27	RZ-L-15-G 1/2"-wd	92,03
L	160	18	G 1/2"	64	48,0	14	36	36	32	RZ-L-18-G 1/2"-wd	120,16
L	160	22	G 3/4"	72	56,0	16	46	41	36	RZ-L-22-G 3/4"-wd	171,80
L	100	28	G 1"	81	64,0	18	55	50	41	RZ-L-28-G 1"-wd	232,64
L	100	35	G 1 1/4"	92	70,0	20	60	60	50	RZ-L-35-G 1 1/4"-wd	334,90
L	100	42	G 1 1/2"	104	71,5	22	70	65	60	RZ-L-42-G 1 1/2"-wd	472,95

Reihe Series	Druck Pressure PB	Rohr A.D. Tube O.D. D1	Gewinde Thread G	Ca. Maße Approx. Dimensions						Bestellzeichen Order-Code Standard	Brutto-Preis Gross-Price Euro (€)
				L1	L2	i	SW1	SW2	SW3		
S	630	6	G 1/4"	46	31,5	12	19	19	17	RZ-S-06-G 1/4"-wd	58,80
S	630	8	G 1/4"	46	31,5	12	22	19	19	RZ-S-08-G 1/4"-wd	61,36
S	630	10	G 3/8"	54	38,0	12	27	24	22	RZ-S-10-G 3/8"-wd	71,58
S	630	12	G 3/8"	57	41,0	12	30	27	24	RZ-S-12-G 3/8"-wd	76,69
S	630	14	G 1/2"	61	43,5	14	32	27	27	RZ-S-14-G 1/2"-wd	86,92
S	400	16	G 1/2"	64	46,0	14	36	32	30	RZ-S-16-G 1/2"-wd	104,82
S	400	20	G 3/4"	72	50,0	16	46	41	36	RZ-S-20-G 3/4"-wd	166,17
S	400	25	G 1"	79	54,5	18	50	46	46	RZ-S-25-G 1"-wd	212,19
S	250	30	G 1 1/4"	91	64,0	20	60	55	50	RZ-S-30-G 1 1/4"-wd	306,78
S	250	38	G 1 1/2"	102	71,5	22	70	65	60	RZ-S-38-G 1 1/2"-wd	414,15

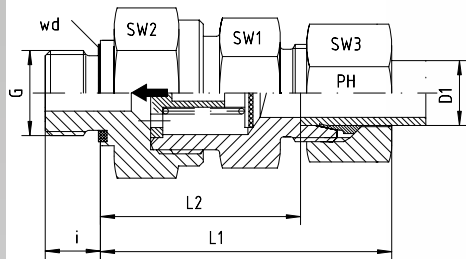

Einschraubgewinde G: Whitworth-Rohrgewinde -
Zylindrisch
Einschraubzapfen mit Weichdichtung - Viton
Strömung zum Einschraubzapfen

*Thread G: BSP - Parallel
Screwed Plug with Captive Seal - Viton
Flow towards Screwed Plug*

Reihe Series	Druck Pressure PB	Rohr A.D. Tube O.D. D1	Gewinde Thread G	Ca. Maße Approx. Dimensions						Bestellzeichen Order-Code SC	Brutto-Preis Gross-Price Euro (€)
				L1	L2	i	SW1	SW2	SW3		
L	250	6	G 1/8"	41	26,5	8	17	17	14	RZ-L-06-G 1/8"-wd-SC	54,01
L	250	8	G 1/4"	43	28,5	12	19	17	17	RZ-L-08-G 1/4"-wd-SC	59,24
L	250	10	G 1/4"	53	38,5	12	24	22	19	RZ-L-10-G 1/4"-wd-SC	69,47
L	250	12	G 3/8"	55	40,5	12	30	27	22	RZ-L-12-G 3/8"-wd-SC	82,37
L	250	15	G 1/2"	58	42,5	14	30	27	27	RZ-L-15-G 1/2"-wd-SC	93,11
L	160	18	G 1/2"	64	48,0	14	36	36	32	RZ-L-18-G 1/2"-wd-SC	121,80
L	160	22	G 3/4"	72	56,0	16	46	41	36	RZ-L-22-G 3/4"-wd-SC	173,56
L	100	28	G 1"	81	64,0	18	55	50	41	RZ-L-28-G 1"-wd-SC	234,64
L	100	35	G 1 1/4"	92	70,0	20	60	60	50	RZ-L-35-G 1 1/4"-wd-SC	338,62
L	100	42	G 1 1/2"	104	71,5	22	70	65	60	RZ-L-42-G 1 1/2"-wd-SC	477,27

Reihe Series	Druck Pressure PB	Rohr A.D. Tube O.D. D1	Gewinde Thread G	Ca. Maße Approx. Dimensions						Bestellzeichen Order-Code SC	Brutto-Preis Gross-Price Euro (€)
				L1	L2	i	SW1	SW2	SW3		
S	630	6	G 1/4"	46	31,5	12	19	19	17	RZ-S-06-G 1/4"-wd-SC	59,24
S	630	8	G 1/4"	46	31,5	12	22	19	19	RZ-S-08-G 1/4"-wd-SC	61,80
S	630	10	G 3/8"	54	38,0	12	27	24	22	RZ-S-10-G 3/8"-wd-SC	72,14
S	630	12	G 3/8"	57	41,0	12	30	27	24	RZ-S-12-G 3/8"-wd-SC	77,53
S	630	14	G 1/2"	61	43,5	14	32	27	27	RZ-S-14-G 1/2"-wd-SC	88,48
S	400	16	G 1/2"	64	46,0	14	36	32	30	RZ-S-16-G 1/2"-wd-SC	106,38
S	400	20	G 3/4"	72	50,0	16	46	41	36	RZ-S-20-G 3/4"-wd-SC	168,05
S	400	25	G 1"	79	54,5	18	50	46	46	RZ-S-25-G 1"-wd-SC	215,19
S	250	30	G 1 1/4"	91	64,0	20	60	55	50	RZ-S-30-G 1 1/4"-wd-SC	310,94
S	250	38	G 1 1/2"	102	71,5	22	70	65	60	RZ-S-38-G 1 1/2"-wd-SC	419,79



Einschraubgewinde G: Whitworth-Rohrgewinde -
Zylindrisch
Einerseits für DIN EN ISO 8434-1 Schneidring
Einschraubzapfen mit Weichdichtung - Viton
Strömung zum Einschraubzapfen

*Thread G: BSP - Parallel
On the one hand for DIN EN ISO 8434-1 Cutting Ring
Screwed Plug with Captive Seal - Viton
Flow towards Screwed Plug*

Reihe Series	Druck Pressure PB	Rohr A.D. Tube O.D. D1	Gewinde Thread G	Ca. Maße Approx. Dimensions						Bestellzeichen Order-Code OMD	Brutto-Preis Gross-Price Euro (€)
L	250	6	G 1/8"							RZ-L-06-G 1/8"-wd-OMD	51,38
L	250	8	G 1/4"							RZ-L-08-G 1/4"-wd-OMD	56,00
L	250	10	G 1/4"							RZ-L-10-G 1/4"-wd-OMD	65,67
L	250	12	G 3/8"							RZ-L-12-G 3/8"-wd-OMD	77,92
L	250	15	G 1/2"							RZ-L-15-G 1/2"-wd-OMD	86,89
L	160	18	G 1/2"							RZ-L-18-G 1/2"-wd-OMD	111,54
L	160	22	G 3/4"							RZ-L-22-G 3/4"-wd-OMD	161,49
L	100	28	G 1"							RZ-L-28-G 1"-wd-OMD	217,79
L	100	35	G 1 1/4"							RZ-L-35-G 1 1/4"-wd-OMD	313,79
L	100	42	G 1 1/2"							RZ-L-42-G 1 1/2"-wd-OMD	445,52

Reihe Series	Druck Pressure PB	Rohr A.D. Tube O.D. D1	Gewinde Thread G	Ca. Maße Approx. Dimensions						Bestellzeichen Order-Code OMD	Brutto-Preis Gross-Price Euro (€)
S	630	6	G 1/4"							RZ-S-06-G 1/4"-wd-OMD	56,01
S	630	8	G 1/4"							RZ-S-08-G 1/4"-wd-OMD	58,16
S	630	10	G 3/8"							RZ-S-10-G 3/8"-wd-OMD	67,64
S	630	12	G 3/8"							RZ-S-12-G 3/8"-wd-OMD	72,24
S	630	14	G 1/2"							RZ-S-14-G 1/2"-wd-OMD	81,42
S	400	16	G 1/2"							RZ-S-16-G 1/2"-wd-OMD	96,61
S	400	20	G 3/4"							RZ-S-20-G 3/4"-wd-OMD	155,59
S	400	25	G 1"							RZ-S-25-G 1"-wd-OMD	193,57
S	250	30	G 1 1/4"							RZ-S-30-G 1 1/4"-wd-OMD	283,34
S	250	38	G 1 1/2"							RZ-S-38-G 1 1/2"-wd-OMD	382,34

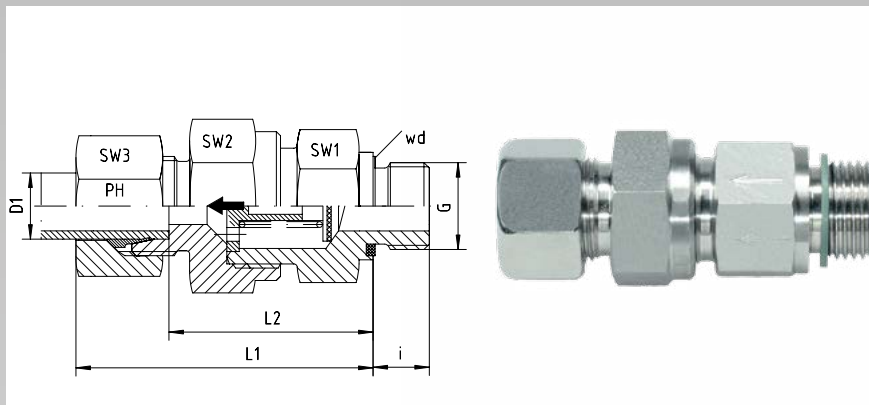

Einschraubgewinde G: Metrisches Feingewinde -
Zylindrisch
Einschraubzapfen mit Weichdichtung - Viton
Strömung vom Einschraubzapfen

*Thread G: Metric - Parallel
Screwed Plug with Captive Seal - Viton
Flow from Screwed Plug*

Reihe Series	Druck Pressure PB	Rohr A.D. Tube O.D. D1	Gewinde Thread G	Ca. Maße Approx. Dimensions						Bestellzeichen Order-Code Standard	Brutto-Preis Gross-Price Euro (€)
				L1	L2	i	SW1	SW2	SW3		
L	250	6	M 10 x 1	43	28,0	8	17	17	14	RV-L-06-M 10x1-wd	53,69
L	250	8	M 12 x 1,5	44	29,0	12	17	19	17	RV-L-08-M 12x1,5-wd	58,80
L	250	10	M 14 x 1,5	53	38,5	12	22	24	19	RV-L-10-M 14x1,5-wd	69,03
L	250	12	M 16 x 1,5	57	42,5	12	27	30	22	RV-L-12-M 16x1,5-wd	81,81
L	250	15	M 18 x 1,5	61	45,5	12	27	30	27	RV-L-15-M 18x1,5-wd	92,03
L	160	18	M 22 x 1,5	66	50,0	14	36	36	32	RV-L-18-M 22x1,5-wd	120,16
L	160	22	M 26 x 1,5	71	55,0	16	41	46	36	RV-L-22-M 26x1,5-wd	171,80
L	100	28	M 33 x 2	80	63,0	18	50	55	41	RV-L-28-M 33x2-wd	232,64
L	100	35	M 42 x 2	91	69,0	20	60	60	50	RV-L-35-M 42x2-wd	334,90
L	100	42	M 48 x 2	104	71,5	22	65	70	60	RV-L-42-M 48x2-wd	472,95

Reihe Series	Druck Pressure PB	Rohr A.D. Tube O.D. D1	Gewinde Thread G	Ca. Maße Approx. Dimensions						Bestellzeichen Order-Code Standard	Brutto-Preis Gross-Price Euro (€)
				L1	L2	i	SW1	SW2	SW3		
S	630	6	M 12 x 1,5	46	31,5	12	19	19	17	RV-S-06-M 12x1,5-wd	58,80
S	630	8	M 14 x 1,5	46	31,5	12	19	22	19	RV-S-08-M 14x1,5-wd	61,36
S	630	10	M 16 x 1,5	54	38,0	12	24	27	22	RV-S-10-M 16x1,5-wd	71,58
S	630	12	M 18 x 1,5	57	41,0	12	27	30	24	RV-S-12-M 18x1,5-wd	76,69
S	630	14	M 20 x 1,5	62	44,5	14	27	32	27	RV-S-14-M 20x1,5-wd	86,92
S	400	16	M 22 x 1,5	66	48,0	14	32	36	30	RV-S-16-M 22x1,5-wd	104,82
S	400	20	M 27 x 2	74	52,0	16	41	46	36	RV-S-20-M 27x2-wd	166,17
S	400	25	M 33 x 2	79	54,5	18	46	50	46	RV-S-25-M 33x2-wd	212,19
S	250	30	M 42 x 2	91	64,0	20	55	60	50	RV-S-30-M 42x2-wd	306,78
S	250	38	M 48 x 2	100	69,5	22	65	70	60	RV-S-38-M 48x2-wd	414,15

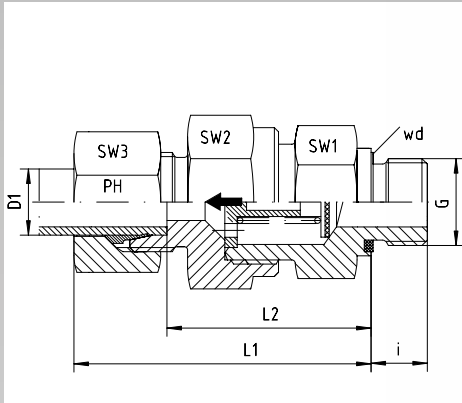

Einschraubgewinde G: Metrisches Feingewinde -
Zylindrisch
Einschraubzapfen mit Weichdichtung - Viton
Strömung vom Einschraubzapfen

*Thread G: Metric - Parallel
Screwed Plug with Captive Seal - Viton
Flow from Screwed Plug*

Reihe Series	Druck Pressure PB	Rohr A.D. Tube O.D. D1	Gewinde Thread G	Ca. Maße Approx. Dimensions						Bestellzeichen Order-Code SC	Brutto-Preis Gross-Price Euro (€)
				L1	L2	i	SW1	SW2	SW3		
L	250	6	M 10 x 1	43	28,0	8	17	17	14	RV-L-06-M 10x1-wd-SC	54,01
L	250	8	M 12 x 1,5	44	29,0	12	17	19	17	RV-L-08-M 12x1,5-wd-SC	59,24
L	250	10	M 14 x 1,5	53	38,5	12	22	24	19	RV-L-10-M 14x1,5-wd-SC	69,47
L	250	12	M 16 x 1,5	57	42,5	12	27	30	22	RV-L-12-M 16x1,5-wd-SC	82,37
L	250	15	M 18 x 1,5	61	45,5	12	27	30	27	RV-L-15-M 18x1,5-wd-SC	93,11
L	160	18	M 22 x 1,5	66	50,0	14	36	36	32	RV-L-18-M 22x1,5-wd-SC	121,80
L	160	22	M 26 x 1,5	71	55,0	16	41	46	36	RV-L-22-M 26x1,5-wd-SC	173,56
L	100	28	M 33 x 2	80	63,0	18	50	55	41	RV-L-28-M 33x2-wd-SC	234,64
L	100	35	M 42 x 2	91	69,0	20	60	60	50	RV-L-35-M 42x2-wd-SC	338,62
L	100	42	M 48 x 2	104	71,5	22	65	70	60	RV-L-42-M 48x2-wd-SC	477,27

Reihe Series	Druck Pressure PB	Rohr A.D. Tube O.D. D1	Gewinde Thread G	Ca. Maße Approx. Dimensions						Bestellzeichen Order-Code SC	Brutto-Preis Gross-Price Euro (€)
				L1	L2	i	SW1	SW2	SW3		
S	630	6	M 12 x 1,5	46	31,5	12	19	19	17	RV-S-06-M 12x1,5-wd-SC	59,24
S	630	8	M 14 x 1,5	46	31,5	12	19	22	19	RV-S-08-M 14x1,5-wd-SC	61,80
S	630	10	M 16 x 1,5	54	38,0	12	24	27	22	RV-S-10-M 16x1,5-wd-SC	72,14
S	630	12	M 18 x 1,5	57	41,0	12	27	30	24	RV-S-12-M 18x1,5-wd-SC	77,53
S	630	14	M 20 x 1,5	62	44,5	14	27	32	27	RV-S-14-M 20x1,5-wd-SC	88,48
S	400	16	M 22 x 1,5	66	48,0	14	32	36	30	RV-S-16-M 22x1,5-wd-SC	106,38
S	400	20	M 27 x 2	74	52,0	16	41	46	36	RV-S-20-M 27x2-wd-SC	168,05
S	400	25	M 33 x 2	79	54,5	18	46	50	46	RV-S-25-M 33x2-wd-SC	215,19
S	250	30	M 42 x 2	91	64,0	20	55	60	50	RV-S-30-M 42x2-wd-SC	310,94
S	250	38	M 48 x 2	100	69,5	22	65	70	60	RV-S-38-M 48x2-wd-SC	419,79



Einschraubgewinde G: Metrisches Feingewinde -
Zylindrisch
Einerseits für DIN EN ISO 8434-1 Schneidring
Einschraubzapfen mit Weichdichtung - Viton
Strömung vom Einschraubzapfen

*Thread G: Metric - Parallel
On the one hand for DIN EN ISO 8434-1 Cutting Ring
Screwed Plug with Captive Seal - Viton
Flow from Screwed Plug*

Reihe Series	Druck Pressure PB	Rohr A.D. Tube O.D. D1	Gewinde Thread G	Ca. Maße Approx. Dimensions						Bestellzeichen Order-Code OMD	Brutto-Preis Gross-Price Euro (€)
L	250	6	M 10 x 1							RV-L-06-M 10x1-wd-OMD	51,38
L	250	8	M 12 x 1,5							RV-L-08-M 12x1,5-wd-OMD	56,00
L	250	10	M 14 x 1,5							RV-L-10-M 14x1,5-wd-OMD	65,67
L	250	12	M 16 x 1,5							RV-L-12-M 16x1,5-wd-OMD	77,92
L	250	15	M 18 x 1,5							RV-L-15-M 18x1,5-wd-OMD	86,89
L	160	18	M 22 x 1,5							RV-L-18-M 22x1,5-wd-OMD	111,54
L	160	22	M 26 x 1,5							RV-L-22-M 26x1,5-wd-OMD	161,49
L	100	28	M 33 x 2							RV-L-28-M 33x2-wd-OMD	217,79
L	100	35	M 42 x 2							RV-L-35-M 42x2-wd-OMD	313,79
L	100	42	M 48 x 2							RV-L-42-M 48x2-wd-OMD	445,52

Reihe Series	Druck Pressure PB	Rohr A.D. Tube O.D. D1	Gewinde Thread G	Ca. Maße Approx. Dimensions						Bestellzeichen Order-Code OMD	Brutto-Preis Gross-Price Euro (€)
S	630	6	M 12 x 1,5							RV-S-06-M 12x1,5-wd-OMD	56,01
S	630	8	M 14 x 1,5							RV-S-08-M 14x1,5-wd-OMD	58,16
S	630	10	M 16 x 1,5							RV-S-10-M 16x1,5-wd-OMD	67,64
S	630	12	M 18 x 1,5							RV-S-12-M 18x1,5-wd-OMD	72,24
S	630	14	M 20 x 1,5							RV-S-14-M 20x1,5-wd-OMD	81,42
S	400	16	M 22 x 1,5							RV-S-16-M 22x1,5-wd-OMD	96,61
S	400	20	M 27 x 2							RV-S-20-M 27x2-wd-OMD	155,59
S	400	25	M 33 x 2							RV-S-25-M 33x2-wd-OMD	193,57
S	250	30	M 42 x 2							RV-S-30-M 42x2-wd-OMD	283,34
S	250	38	M 48 x 2							RV-S-38-M 48x2-wd-OMD	382,34

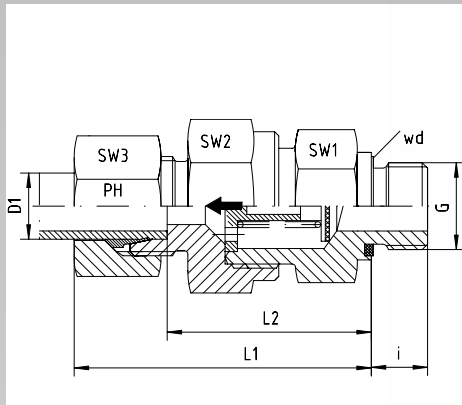

Einschraubgewinde G: Whitworth-Rohrgewinde -
Zylindrisch
Einschraubzapfen mit Weichdichtung - Viton
Strömung vom Einschraubzapfen

Thread G: BSP - Parallel
Screwed Plug with Captive Seal - Viton
Flow from Screwed Plug

Reihe Series	Druck Pressure PB	Rohr A.D. Tube O.D. D1	Gewinde Thread G	Ca. Maße Approx. Dimensions						Bestellzeichen Order-Code Standard	Brutto-Preis Gross-Price Euro (€)
				L1	L2	i	SW1	SW2	SW3		
L	250	6	G 1/8"	43	28,0	8	17	17	14	RV-L-06-G 1/8"-wd	53,69
L	250	8	G 1/4"	45	30,0	12	19	19	17	RV-L-08-G 1/4"-wd	58,80
L	250	10	G 1/4"	53	38,5	12	22	24	19	RV-L-10-G 1/4"-wd	69,03
L	250	12	G 3/8"	57	42,5	12	27	30	22	RV-L-12-G 3/8"-wd	81,81
L	250	15	G 1/2"	61	45,5	14	27	30	27	RV-L-15-G 1/2"-wd	92,03
L	160	18	G 1/2"	66	50,0	14	36	36	32	RV-L-18-G 1/2"-wd	120,16
L	160	22	G 3/4"	71	55,0	16	41	46	36	RV-L-22-G 3/4"-wd	171,80
L	100	28	G 1"	80	63,0	18	50	55	41	RV-L-28-G 1"-wd	232,64
L	100	35	G 1 1/4"	91	69,0	20	60	60	50	RV-L-35-G 1 1/4"-wd	334,90
L	100	42	G 1 1/2"	104	71,5	22	65	70	60	RV-L-42-G 1 1/2"-wd	472,95

Reihe Series	Druck Pressure PB	Rohr A.D. Tube O.D. D1	Gewinde Thread G	Ca. Maße Approx. Dimensions						Bestellzeichen Order-Code Standard	Brutto-Preis Gross-Price Euro (€)
				L1	L2	i	SW1	SW2	SW3		
S	630	6	G 1/4"	46	31,5	12	19	19	17	RV-S-06-G 1/4"-wd	58,80
S	630	8	G 1/4"	46	31,5	12	19	22	19	RV-S-08-G 1/4"-wd	61,36
S	630	10	G 3/8"	54	38,0	12	24	27	22	RV-S-10-G 3/8"-wd	71,58
S	630	12	G 3/8"	57	41,0	12	27	30	24	RV-S-12-G 3/8"-wd	76,69
S	630	14	G 1/2"	62	44,5	14	27	32	27	RV-S-14-G 1/2"-wd	86,92
S	400	16	G 1/2"	66	48,0	14	32	36	30	RV-S-16-G 1/2"-wd	104,82
S	400	20	G 3/4"	74	52,0	16	41	46	36	RV-S-20-G 3/4"-wd	166,17
S	400	25	G 1"	79	54,5	18	46	50	46	RV-S-25-G 1"-wd	212,19
S	250	30	G 1 1/4"	91	64,0	20	55	60	50	RV-S-30-G 1 1/4"-wd	306,78
S	250	38	G 1 1/2"	100	69,5	22	65	70	60	RV-S-38-G 1 1/2"-wd	414,15

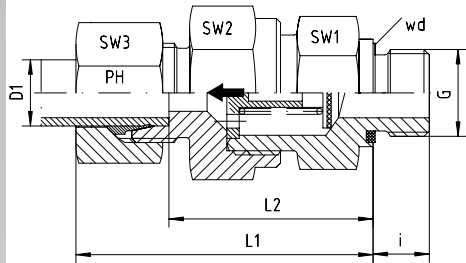

Einschraubgewinde G: Whitworth-Rohrgewinde -
Zylindrisch
Einschraubzapfen mit Weichdichtung - Viton
Strömung vom Einschraubzapfen

Thread G: BSP - Parallel
Screwed Plug with Captive Seal - Viton
Flow from Screwed Plug

Reihe Series	Druck Pressure PB	Rohr A.D. Tube O.D. D1	Gewinde Thread G	Ca. Maße Approx. Dimensions						Bestellzeichen Order-Code SC	Brutto-Preis Gross-Price Euro (€)
				L1	L2	i	SW1	SW2	SW3		
L	250	6	G 1/8"	43	28,0	8	17	17	14	RV-L-06-G 1/8"-wd-SC	54,01
L	250	8	G 1/4"	45	30,0	12	19	19	17	RV-L-08-G 1/4"-wd-SC	59,24
L	250	10	G 1/4"	53	38,5	12	22	24	19	RV-L-10-G 1/4"-wd-SC	69,47
L	250	12	G 3/8"	57	42,5	12	27	30	22	RV-L-12-G 3/8"-wd-SC	82,37
L	250	15	G 1/2"	61	45,5	14	27	30	27	RV-L-15-G 1/2"-wd-SC	93,11
L	160	18	G 1/2"	66	50,0	14	36	36	32	RV-L-18-G 1/2"-wd-SC	121,80
L	160	22	G 3/4"	71	55,0	16	41	46	36	RV-L-22-G 3/4"-wd-SC	173,56
L	100	28	G 1"	80	63,0	18	50	55	41	RV-L-28-G 1"-wd-SC	234,64
L	100	35	G 1 1/4"	91	69,0	20	60	60	50	RV-L-35-G 1 1/4"-wd-SC	338,62
L	100	42	G 1 1/2"	104	71,5	22	65	70	60	RV-L-42-G 1 1/2"-wd-SC	477,27

Reihe Series	Druck Pressure PB	Rohr A.D. Tube O.D. D1	Gewinde Thread G	Ca. Maße Approx. Dimensions						Bestellzeichen Order-Code SC	Brutto-Preis Gross-Price Euro (€)
				L1	L2	i	SW1	SW2	SW3		
S	630	6	G 1/4"	46	31,5	12	19	19	17	RV-S-06-G 1/4"-wd-SC	59,24
S	630	8	G 1/4"	46	31,5	12	19	22	19	RV-S-08-G 1/4"-wd-SC	61,80
S	630	10	G 3/8"	54	38,0	12	24	27	22	RV-S-10-G 3/8"-wd-SC	72,14
S	630	12	G 3/8"	57	41,0	12	27	30	24	RV-S-12-G 3/8"-wd-SC	77,53
S	630	14	G 1/2"	62	44,5	14	27	32	27	RV-S-14-G 1/2"-wd-SC	88,48
S	400	16	G 1/2"	66	48,0	14	32	36	30	RV-S-16-G 1/2"-wd-SC	106,38
S	400	20	G 3/4"	74	52,0	16	41	46	36	RV-S-20-G 3/4"-wd-SC	168,05
S	400	25	G 1"	79	54,5	18	46	50	46	RV-S-25-G 1"-wd-SC	215,19
S	250	30	G 1 1/4"	91	64,0	20	55	60	50	RV-S-30-G 1 1/4"-wd-SC	310,94
S	250	38	G 1 1/2"	100	69,5	22	65	70	60	RV-S-38-G 1 1/2"-wd-SC	419,79



Einschraubgewinde G: Whitworth-Rohrgewinde -
Zylindrisch
Einerseits für DIN EN ISO 8434-1 Schneidring
Einschraubzapfen mit Weichdichtung - Viton
Strömung vom Einschraubzapfen

*Thread G: BSP - Parallel
On the one hand for DIN EN ISO 8434-1 Cutting Ring
Screwed Plug with Captive Seal - Viton
Flow from Screwed Plug*

Reihe Series	Druck Pressure PB	Rohr A.D. Tube O.D. D1	Gewinde Thread G	Ca. Maße Approx. Dimensions						Bestellzeichen Order-Code OMD	Brutto-Preis Gross-Price Euro (€)
L	250	6	G 1/8"							RV-L-06-G 1/8"-wd-OMD	51,38
L	250	8	G 1/4"							RV-L-08-G 1/4"-wd-OMD	56,00
L	250	10	G 1/4"							RV-L-10-G 1/4"-wd-OMD	65,67
L	250	12	G 3/8"							RV-L-12-G 3/8"-wd-OMD	77,92
L	250	15	G 1/2"							RV-L-15-G 1/2"-wd-OMD	86,89
L	160	18	G 1/2"							RV-L-18-G 1/2"-wd-OMD	111,54
L	160	22	G 3/4"							RV-L-22-G 3/4"-wd-OMD	161,49
L	100	28	G 1"							RV-L-28-G 1"-wd-OMD	217,79
L	100	35	G 1 1/4"							RV-L-35-G 1 1/4"-wd-OMD	313,79
L	100	42	G 1 1/2"							RV-L-42-G 1 1/2"-wd-OMD	445,52

Reihe Series	Druck Pressure PB	Rohr A.D. Tube O.D. D1	Gewinde Thread G	Ca. Maße Approx. Dimensions						Bestellzeichen Order-Code OMD	Brutto-Preis Gross-Price Euro (€)
S	630	6	G 1/4"							RV-S-06-G 1/4"-wd-OMD	56,01
S	630	8	G 1/4"							RV-S-08-G 1/4"-wd-OMD	58,16
S	630	10	G 3/8"							RV-S-10-G 3/8"-wd-OMD	67,64
S	630	12	G 3/8"							RV-S-12-G 3/8"-wd-OMD	72,24
S	630	14	G 1/2"							RV-S-14-G 1/2"-wd-OMD	81,42
S	400	16	G 1/2"							RV-S-16-G 1/2"-wd-OMD	96,61
S	400	20	G 3/4"							RV-S-20-G 3/4"-wd-OMD	155,59
S	400	25	G 1"							RV-S-25-G 1"-wd-OMD	193,57
S	250	30	G 1 1/4"							RV-S-30-G 1 1/4"-wd-OMD	283,34
S	250	38	G 1 1/2"							RV-S-38-G 1 1/2"-wd-OMD	382,34



Beiderseits Schneidringanschluss

Tube Cutting Ring Connection at both Ends

Reihe Series	Druck Pressure PB	Rohr A.D. Tube O.D. D1	Ca. Maße Approx. Dimensions					Bestellzeichen Order-Code Standard	Brutto-Preis Gross-Price Euro (€)
			L1	L2	SW1	SW2	SW3		
L	250	6	58	29,0	17	17	14	RD-L-06	56,24
L	250	8	59	30,0	17	19	17	RD-L-08	61,36
L	250	10	70	40,5	22	24	19	RD-L-10	76,69
L	250	12	73	43,5	27	30	22	RD-L-12	84,36
L	250	15	78	47,5	27	30	27	RD-L-15	99,70
L	160	18	84	51,5	36	36	32	RD-L-18	130,38
L	160	22	94	61,5	41	46	36	RD-L-22	173,84
L	100	28	103	69,5	50	55	41	RD-L-28	222,93
L	100	35	118	74,5	60	60	50	RD-L-35	304,22
L	100	42	122	74,0	65	70	60	RD-L-42	457,61

Reihe Series	Druck Pressure PB	Rohr A.D. Tube O.D. D1	Ca. Maße Approx. Dimensions					Bestellzeichen Order-Code Standard	Brutto-Preis Gross-Price Euro (€)
			L1	L2	SW1	SW2	SW3		
S	630	6	64	34,5	19	19	17	RD-S-06	63,91
S	630	8	64	34,5	19	22	19	RD-S-08	66,47
S	630	10	73	40,5	24	27	22	RD-S-10	74,14
S	630	12	75	42,5	27	30	24	RD-S-12	81,81
S	630	14	83	47,5	27	32	27	RD-S-14	92,03
S	400	16	87	50,5	32	36	30	RD-S-16	112,49
S	400	20	98	54,5	41	46	36	RD-S-20	173,84
S	400	25	107	58,5	46	50	46	RD-S-25	209,12
S	250	30	123	69,5	55	60	50	RD-S-30	309,34
S	250	38	140	75,5	65	70	60	RD-S-38	444,83

Beiderseits Schneidringanschluss

Tube Cutting Ring Connection at both Ends

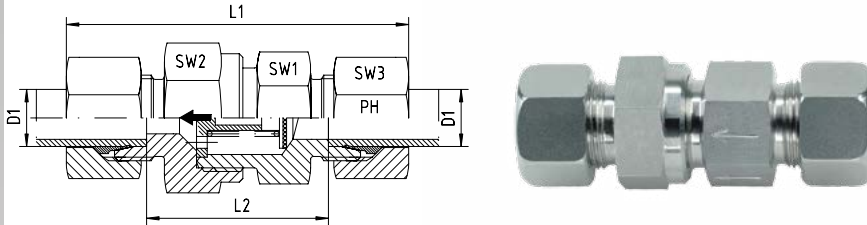

Reihe Series	Druck Pressure PB	Rohr A.D. Tube O.D. D1	Ca. Maße Approx. Dimensions					Bestellzeichen Order-Code SC	Brutto-Preis Gross-Price Euro (€)
			L1	L2	SW1	SW2	SW3		
L	250	6	58	29,0	17	17	14	RD-L-06-SC	56,88
L	250	8	59	30,0	17	19	17	RD-L-08-SC	62,24
L	250	10	70	40,5	22	24	19	RD-L-10-SC	77,57
L	250	12	73	43,5	27	30	22	RD-L-12-SC	85,48
L	250	15	78	47,5	27	30	27	RD-L-15-SC	101,86
L	160	18	84	51,5	36	36	32	RD-L-18-SC	133,66
L	160	22	94	61,5	41	46	36	RD-L-22-SC	177,36
L	100	28	103	69,5	50	55	41	RD-L-28-SC	226,93
L	100	35	118	74,5	60	60	50	RD-L-35-SC	311,66
L	100	42	122	74,0	65	70	60	RD-L-42-SC	466,25

Reihe Series	Druck Pressure PB	Rohr A.D. Tube O.D. D1	Ca. Maße Approx. Dimensions					Bestellzeichen Order-Code SC	Brutto-Preis Gross-Price Euro (€)
			L1	L2	SW1	SW2	SW3		
S	630	6	64	34,5	19	19	17	RD-S-06-SC	64,79
S	630	8	64	34,5	19	22	19	RD-S-08-SC	67,35
S	630	10	73	40,5	24	27	22	RD-S-10-SC	75,26
S	630	12	75	42,5	27	30	24	RD-S-12-SC	83,49
S	630	14	83	47,5	27	32	27	RD-S-14-SC	95,15
S	400	16	87	50,5	32	36	30	RD-S-16-SC	115,61
S	400	20	98	54,5	41	46	36	RD-S-20-SC	177,60
S	400	25	107	58,5	46	50	46	RD-S-25-SC	215,12
S	250	30	123	69,5	55	60	50	RD-S-30-SC	317,66
S	250	38	140	75,5	65	70	60	RD-S-38-SC	456,11

Beiderseits für DIN EN ISO 8434-1 Schneidring-
anschluss

*Tube Cutting Ring Connection at both Ends for
DIN EN ISO 8434-1*



Reihe Series	Druck Pressure PB	Rohr A.D. Tube O.D. D1	Ca. Maße Approx. Dimensions				Bestellzeichen Order-Code OMD	Brutto-Preis Gross-Price Euro (€)
L	250	6					RD-L-06-OMD	51,62
L	250	8					RD-L-08-OMD	55,76
L	250	10					RD-L-10-OMD	69,97
L	250	12					RD-L-12-OMD	76,58
L	250	15					RD-L-15-OMD	89,42
L	160	18					RD-L-18-OMD	113,14
L	160	22					RD-L-22-OMD	153,22
L	100	28					RD-L-28-OMD	193,23
L	100	35					RD-L-35-OMD	262,00
L	100	42					RD-L-42-OMD	402,75

Reihe Series	Druck Pressure PB	Rohr A.D. Tube O.D. D1	Ca. Maße Approx. Dimensions				Bestellzeichen Order-Code OMD	Brutto-Preis Gross-Price Euro (€)
S	630	6					RD-S-06-OMD	58,33
S	630	8					RD-S-08-OMD	60,07
S	630	10					RD-S-10-OMD	66,26
S	630	12					RD-S-12-OMD	72,91
S	630	14					RD-S-14-OMD	81,03
S	400	16					RD-S-16-OMD	96,07
S	400	20					RD-S-20-OMD	152,68
S	400	25					RD-S-25-OMD	171,88
S	250	30					RD-S-30-OMD	262,46
S	250	38					RD-S-38-OMD	381,55

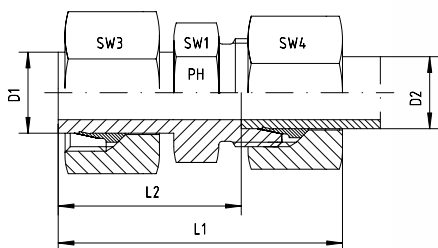

Anschluss D1 ist vormontiert. Die Fertigmontage erfolgt im Stutzen mit ca. 1/2 Umdrehung der Überwurfmutter über den Punkt des deutlich spürbaren Kraftanstieges.

Port D1 is pre-assembled. Final assembly in appropriate body with approx. 1/2 turn beyond the point of clearly perceptible resistance.

Reihe Series	Druck Pressure PN	Rohr A.D. Tube O.D. D1	Rohr A.D. Tube O.D. D2	Ca. Maße Approx. Dimensions					Bestellzeichen Order-Code Standard	Brutto-Preis Gross-Price Euro (€)
				L1	L2	SW1	SW3	SW4		
S	630	8	6	47,0	32,0	14	19	17	KOR-S-08/06	17,54
S	630	10	6	48,0	33,0	14	22	17	KOR-S-10/06	17,79
S	630	10	8	48,0	33,0	17	22	19	KOR-S-10/08	18,30
S	630	12	6	50,0	35,0	14	24	17	KOR-S-12/06	19,17
S	630	12	8	50,0	35,0	17	24	19	KOR-S-12/08	20,61
S	630	12	10	51,0	34,5	19	24	22	KOR-S-12/10	21,42
S	630	14	6	50,0	35,0	17	27	17	KOR-S-14/06	20,71
S	630	14	8	50,0	35,0	17	27	19	KOR-S-14/08	21,30
S	630	14	10	51,0	34,5	19	27	22	KOR-S-14/10	22,39
S	630	14	12	51,0	34,5	22	27	24	KOR-S-14/12	24,34
S	400	16	6	54,0	39,0	17	30	17	KOR-S-16/06	26,15
S	400	16	8	54,0	39,0	17	30	19	KOR-S-16/08	26,26
S	400	16	10	55,0	38,5	19	30	22	KOR-S-16/10	27,28
S	400	16	12	55,0	38,5	22	30	24	KOR-S-16/12	29,25
S	400	16	14	58,0	40,0	22	30	27	KOR-S-16/14	28,35
S	400	20	6	58,5	43,5	22	36	17	KOR-S-20/06	28,89
S	400	20	8	58,5	43,5	22	36	19	KOR-S-20/08	29,09
S	400	20	10	59,5	43,0	22	36	22	KOR-S-20/10	32,57
S	400	20	12	59,5	43,0	22	36	24	KOR-S-20/12	33,15
S	400	20	14	60,5	42,5	22	36	27	KOR-S-20/14	35,64
S	400	20	16	63,0	44,5	24	36	30	KOR-S-20/16	40,41
S	400	25	6	59,0	44,0	27	46	17	KOR-S-25/06	43,46
S	400	25	8	59,0	44,0	27	46	19	KOR-S-25/08	43,72
S	400	25	10	61,0	44,5	27	46	22	KOR-S-25/10	44,89
S	400	25	12	63,0	46,5	27	46	24	KOR-S-25/12	51,90
S	400	25	14	64,0	46,0	27	46	27	KOR-S-25/14	51,03
S	400	25	16	67,0	48,5	27	46	30	KOR-S-25/16	53,69
S	400	25	20	70,0	48,5	30	46	36	KOR-S-25/20	61,36
S	400	30	6	69,0	54,0	32	50	17	KOR-S-30/06	66,47
S	400	30	8	69,0	54,0	32	50	19	KOR-S-30/08	66,47
S	400	30	10	70,0	53,5	32	50	22	KOR-S-30/10	69,03
S	400	30	12	70,0	53,5	32	50	24	KOR-S-30/12	71,58
S	400	30	14	71,0	53,0	32	50	27	KOR-S-30/14	76,69
S	400	30	16	73,0	54,5	32	50	30	KOR-S-30/16	76,69
S	400	30	20	76,0	54,5	32	50	36	KOR-S-30/20	79,25
S	400	30	25	81,5	57,5	36	50	46	KOR-S-30/25	84,36
S	250	38	6	70,0	55,0	41	60	17	KOR-S-38/06	92,03
S	250	38	8	70,0	55,0	41	60	19	KOR-S-38/08	92,03
S	250	38	10	71,0	54,5	41	60	22	KOR-S-38/10	92,03
S	250	38	12	71,0	54,5	41	60	24	KOR-S-38/12	92,03
S	250	38	14	74,0	56,0	41	60	27	KOR-S-38/14	99,70
S	250	38	16	74,0	55,5	41	60	30	KOR-S-38/16	99,70
S	250	38	20	79,0	57,5	41	60	36	KOR-S-38/20	99,70
S	250	38	25	84,0	60,0	41	60	46	KOR-S-38/25	107,37
S	250	38	30	87,0	60,5	46	60	50	KOR-S-38/30	112,49

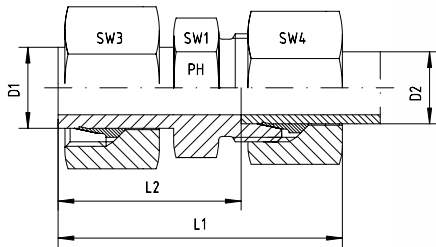

Anschluss D1 ist vormontiert. Die Fertigmontage erfolgt im Stutzen mit ca. 1/2 Umdrehung der Überwurfmutter über den Punkt des deutlich spürbaren Kraftanstieges.

Port D1 is pre-assembled. Final assembly in appropriate body with approx. 1/2 turn beyond the point of clearly perceptible resistance.

Reihe Series	Druck Pressure PN	Rohr A.D. Tube O.D. D1	Rohr A.D. Tube O.D. D2	Ca. Maße Approx. Dimensions					Bestellzeichen Order-Code SC	Brutto-Preis Gross-Price Euro (€)
				L1	L2	SW1	SW3	SW4		
S	630	8	6	47,0	32,0	14	19	17	KOR-S-08/06-SC	18,42
S	630	10	6	48,0	33,0	14	22	17	KOR-S-10/06-SC	18,79
S	630	10	8	48,0	33,0	17	22	19	KOR-S-10/08-SC	19,30
S	630	12	6	50,0	35,0	14	24	17	KOR-S-12/06-SC	20,45
S	630	12	8	50,0	35,0	17	24	19	KOR-S-12/08-SC	21,89
S	630	12	10	51,0	34,5	19	24	22	KOR-S-12/10-SC	22,82
S	630	14	6	50,0	35,0	17	27	17	KOR-S-14/06-SC	22,71
S	630	14	8	50,0	35,0	17	27	19	KOR-S-14/08-SC	23,30
S	630	14	10	51,0	34,5	19	27	22	KOR-S-14/10-SC	24,51
S	630	14	12	51,0	34,5	22	27	24	KOR-S-14/12-SC	26,74
S	400	16	6	54,0	39,0	17	30	17	KOR-S-16/06-SC	28,15
S	400	16	8	54,0	39,0	17	30	19	KOR-S-16/08-SC	28,26
S	400	16	10	55,0	38,5	19	30	22	KOR-S-16/10-SC	29,40
S	400	16	12	55,0	38,5	22	30	24	KOR-S-16/12-SC	31,65
S	400	16	14	58,0	40,0	22	30	27	KOR-S-16/14-SC	31,47
S	400	20	6	58,5	43,5	22	36	17	KOR-S-20/06-SC	31,21
S	400	20	8	58,5	43,5	22	36	19	KOR-S-20/08-SC	31,41
S	400	20	10	59,5	43,0	22	36	22	KOR-S-20/10-SC	35,01
S	400	20	12	59,5	43,0	22	36	24	KOR-S-20/12-SC	35,87
S	400	20	14	60,5	42,5	22	36	27	KOR-S-20/14-SC	39,08
S	400	20	16	63,0	44,5	24	36	30	KOR-S-20/16-SC	43,85
S	400	25	6	59,0	44,0	27	46	17	KOR-S-25/06-SC	46,90
S	400	25	8	59,0	44,0	27	46	19	KOR-S-25/08-SC	47,16
S	400	25	10	61,0	44,5	27	46	22	KOR-S-25/10-SC	48,45
S	400	25	12	63,0	46,5	27	46	24	KOR-S-25/12-SC	55,74
S	400	25	14	64,0	46,0	27	46	27	KOR-S-25/14-SC	55,59
S	400	25	16	67,0	48,5	27	46	30	KOR-S-25/16-SC	58,25
S	400	25	20	70,0	48,5	30	46	36	KOR-S-25/20-SC	66,24
S	400	30	6	69,0	54,0	32	50	17	KOR-S-30/06-SC	71,07
S	400	30	8	69,0	54,0	32	50	19	KOR-S-30/08-SC	71,07
S	400	30	10	70,0	53,5	32	50	22	KOR-S-30/10-SC	73,75
S	400	30	12	70,0	53,5	32	50	24	KOR-S-30/12-SC	76,58
S	400	30	14	71,0	53,0	32	50	27	KOR-S-30/14-SC	82,41
S	400	30	16	73,0	54,5	32	50	30	KOR-S-30/16-SC	82,41
S	400	30	20	76,0	54,5	32	50	36	KOR-S-30/20-SC	85,29
S	400	30	25	81,5	57,5	36	50	46	KOR-S-30/25-SC	91,52
S	250	38	6	70,0	55,0	41	60	17	KOR-S-38/06-SC	98,11
S	250	38	8	70,0	55,0	41	60	19	KOR-S-38/08-SC	98,11
S	250	38	10	71,0	54,5	41	60	22	KOR-S-38/10-SC	98,23
S	250	38	12	71,0	54,5	41	60	24	KOR-S-38/12-SC	98,51
S	250	38	14	74,0	56,0	41	60	27	KOR-S-38/14-SC	106,90
S	250	38	16	74,0	55,5	41	60	30	KOR-S-38/16-SC	106,90
S	250	38	20	79,0	57,5	41	60	36	KOR-S-38/20-SC	107,22
S	250	38	25	84,0	60,0	41	60	46	KOR-S-38/25-SC	116,01
S	250	38	30	87,0	60,5	46	60	50	KOR-S-38/30-SC	122,29



Anschluss D1 ist vormontiert. Die Fertigmontage erfolgt im Stutzen mit ca. 1/2 Umdrehung der Überwurfmutter über den Punkt des deutlich spürbaren Kraftanstieges.

Port D1 is pre-assembled. Final assembly in appropriate body with approx. 1/2 turn beyond the point of clearly perceptible resistance.

Reihe Series	Druck Pressure PN	Rohr A.D. Tube O.D. D1	Rohr A.D. Tube O.D. D2	Ca. Maße Approx. Dimensions					Bestellzeichen Order-Code OMD	Brutto-Preis Gross-Price Euro (€)
S	630	8	6						KOR-S-08/06-OMD	14,75
S	630	10	6						KOR-S-10/06-OMD	15,00
S	630	10	8						KOR-S-10/08-OMD	15,10
S	630	12	6						KOR-S-12/06-OMD	16,38
S	630	12	8						KOR-S-12/08-OMD	17,41
S	630	12	10						KOR-S-12/10-OMD	17,48
S	630	14	6						KOR-S-14/06-OMD	17,92
S	630	14	8						KOR-S-14/08-OMD	18,10
S	630	14	10						KOR-S-14/10-OMD	18,45
S	630	14	12						KOR-S-14/12-OMD	19,89
S	400	16	6						KOR-S-16/06-OMD	23,36
S	400	16	8						KOR-S-16/08-OMD	23,06
S	400	16	10						KOR-S-16/10-OMD	23,34
S	400	16	12						KOR-S-16/12-OMD	24,80
S	400	16	14						KOR-S-16/14-OMD	22,85
S	400	20	6						KOR-S-20/06-OMD	26,10
S	400	20	8						KOR-S-20/08-OMD	25,89
S	400	20	10						KOR-S-20/10-OMD	28,63
S	400	20	12						KOR-S-20/12-OMD	28,70
S	400	20	14						KOR-S-20/14-OMD	30,14
S	400	20	16						KOR-S-20/16-OMD	32,20
S	400	25	6						KOR-S-25/06-OMD	40,67
S	400	25	8						KOR-S-25/08-OMD	40,52
S	400	25	10						KOR-S-25/10-OMD	40,95
S	400	25	12						KOR-S-25/12-OMD	47,45
S	400	25	14						KOR-S-25/14-OMD	45,53
S	400	25	16						KOR-S-25/16-OMD	45,48
S	400	25	20						KOR-S-25/20-OMD	50,78
S	400	30	6						KOR-S-30/06-OMD	63,68
S	400	30	8						KOR-S-30/08-OMD	63,27
S	400	30	10						KOR-S-30/10-OMD	65,09
S	400	30	12						KOR-S-30/12-OMD	67,13
S	400	30	14						KOR-S-30/14-OMD	71,19
S	400	30	16						KOR-S-30/16-OMD	68,48
S	400	30	20						KOR-S-30/20-OMD	68,67
S	400	30	25						KOR-S-30/25-OMD	65,74
S	250	38	6						KOR-S-38/06-OMD	89,24
S	250	38	8						KOR-S-38/08-OMD	88,83
S	250	38	10						KOR-S-38/10-OMD	88,09
S	250	38	12						KOR-S-38/12-OMD	87,58
S	250	38	14						KOR-S-38/14-OMD	94,20
S	250	38	16						KOR-S-38/16-OMD	91,49
S	250	38	20						KOR-S-38/20-OMD	89,12
S	250	38	25						KOR-S-38/25-OMD	88,75
S	250	38	30						KOR-S-38/30-OMD	89,05

KONUS-REDUZIERANSCHLÜSSE

TUBE END REDUCERS

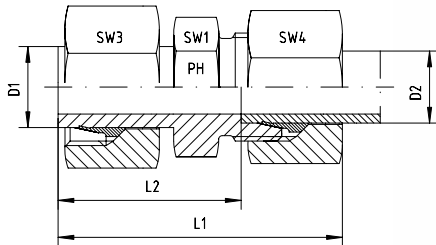

Anschluss D1 ist vormontiert. Die Fertigmontage erfolgt im Stutzen mit ca. 1/2 Umdrehung der Überwurfmutter über den Punkt des deutlich spürbaren Kraftanstieges.

Port D1 is pre-assembled. Final assembly in appropriate body with approx. 1/2 turn beyond the point of clearly perceptible resistance.

Reihe Series	Druck Pressure PN	Rohr A.D. Tube O.D. D1	Rohr A.D. Tube O.D. D2	Ca. Maße Approx. Dimensions					Bestellzeichen Order-Code Standard	Brutto-Preis Gross-Price Euro (€)
				L1	L2	SW1	SW3	SW4		
LL	100	6	4	35,0	23,0	10	12	10	KOR-LL-06/04	11,90
L	315	8	6	43,5	25,5	12	17	14	KOR-L-08/06	12,48
L	315	10	6	44,0	29,0	12	19	14	KOR-L-10/06	12,96
L	315	10	8	44,0	29,0	14	19	17	KOR-L-10/08	13,75
L	315	12	6	44,0	29,0	14	22	14	KOR-L-12/06	17,33
L	315	12	8	44,0	29,0	14	22	17	KOR-L-12/08	18,36
L	315	12	10	45,0	30,0	17	22	19	KOR-L-12/10	18,71
L	315	15	6	45,5	30,5	17	27	14	KOR-L-15/06	19,33
L	315	15	8	45,5	30,5	17	27	17	KOR-L-15/08	19,74
L	315	15	10	46,5	31,5	17	27	19	KOR-L-15/10	20,25
L	315	15	12	46,5	31,5	19	27	22	KOR-L-15/12	20,96
L	315	18	6	47,5	32,5	19	32	14	KOR-L-18/06	23,78
L	315	18	8	47,5	32,5	19	32	17	KOR-L-18/08	21,60
L	315	18	10	48,0	33,0	19	32	19	KOR-L-18/10	22,06
L	315	18	12	48,0	33,0	19	32	22	KOR-L-18/12	24,54
L	315	18	15	49,0	34,0	22	32	27	KOR-L-18/15	25,92
L	160	22	6	50,0	35,0	24	36	14	KOR-L-22/06	27,76
L	160	22	8	50,0	35,0	24	36	17	KOR-L-22/08	26,69
L	160	22	10	51,0	36,0	24	36	19	KOR-L-22/10	27,61
L	160	22	12	51,0	36,0	24	36	22	KOR-L-22/12	30,83
L	160	22	15	52,0	37,0	24	36	27	KOR-L-22/15	34,26
L	160	22	18	53,0	36,5	27	36	32	KOR-L-22/18	38,02
L	160	28	6	50,0	35,0	30	41	14	KOR-L-28/06	37,17
L	160	28	8	50,0	35,0	30	41	17	KOR-L-28/08	38,86
L	160	28	10	51,0	36,0	30	41	19	KOR-L-28/10	40,14
L	160	28	12	51,0	36,0	30	41	22	KOR-L-28/12	42,44
L	160	28	15	52,0	37,0	30	41	27	KOR-L-28/15	43,08
L	160	28	18	54,0	37,5	30	41	32	KOR-L-28/18	47,81
L	160	28	22	55,5	39,0	30	41	36	KOR-L-28/22	50,87
L	160	35	6	58,0	43,0	36	50	14	KOR-L-35/06	56,75
L	160	35	8	58,0	43,0	36	50	17	KOR-L-35/08	57,27
L	160	35	10	59,0	44,0	36	50	19	KOR-L-35/10	58,80
L	160	35	12	59,0	44,0	36	50	22	KOR-L-35/12	58,80
L	160	35	15	60,0	45,0	36	50	27	KOR-L-35/15	61,36
L	160	35	18	61,0	44,5	36	50	32	KOR-L-35/18	63,91
L	160	35	22	63,0	46,5	36	50	36	KOR-L-35/22	63,91
L	160	35	28	63,0	46,5	41	50	41	KOR-L-35/28	66,47
L	160	42	6	59,0	44,0	36	60	14	KOR-L-42/06	*
L	160	42	8	59,0	44,0	46	60	17	KOR-L-42/08	*
L	160	42	10	60,0	45,0	46	60	19	KOR-L-42/10	74,14
L	160	42	12	60,0	45,0	46	60	22	KOR-L-42/12	76,69
L	160	42	15	61,0	46,0	46	60	27	KOR-L-42/15	79,25
L	160	42	18	59,0	44,0	46	60	32	KOR-L-42/18	79,25
L	160	42	22	63,0	46,5	46	60	36	KOR-L-42/22	81,81
L	160	42	28	64,0	47,5	46	60	41	KOR-L-42/28	84,36
L	160	42	35	69,0	47,5	46	60	50	KOR-L-42/35	89,48

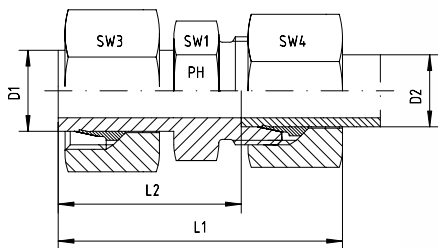

Anschluss D1 ist vormontiert. Die Fertigmontage erfolgt im Stutzen mit ca. 1/2 Umdrehung der Überwurfmutter über den Punkt des deutlich spürbaren Kraftanstieges.

Port D1 is pre-assembled. Final assembly in appropriate body with approx. 1/2 turn beyond the point of clearly perceptible resistance.

Reihe Series	Druck Pressure PN	Rohr A.D. Tube O.D. D1	Rohr A.D. Tube O.D. D2	Ca. Maße Approx. Dimensions					Bestellzeichen Order-Code SC	Brutto-Preis Gross-Price Euro (€)
				L1	L2	SW1	SW3	SW4		
L	315	8	6	43,5	25,5	12	17	14	KOR-L-08/06-SC	13,24
L	315	10	6	44,0	29,0	12	19	14	KOR-L-10/06-SC	13,72
L	315	10	8	44,0	29,0	14	19	17	KOR-L-10/08-SC	14,63
L	315	12	6	44,0	29,0	14	22	14	KOR-L-12/06-SC	18,21
L	315	12	8	44,0	29,0	14	22	17	KOR-L-12/08-SC	19,36
L	315	12	10	45,0	30,0	17	22	19	KOR-L-12/10-SC	19,71
L	315	15	6	45,5	30,5	17	27	14	KOR-L-15/06-SC	20,73
L	315	15	8	45,5	30,5	17	27	17	KOR-L-15/08-SC	21,26
L	315	15	10	46,5	31,5	17	27	19	KOR-L-15/10-SC	21,77
L	315	15	12	46,5	31,5	19	27	22	KOR-L-15/12-SC	22,60
L	315	18	6	47,5	32,5	19	32	14	KOR-L-18/06-SC	25,74
L	315	18	8	47,5	32,5	19	32	17	KOR-L-18/08-SC	23,68
L	315	18	10	48,0	33,0	19	32	19	KOR-L-18/10-SC	24,14
L	315	18	12	48,0	33,0	19	32	22	KOR-L-18/12-SC	26,74
L	315	18	15	49,0	34,0	22	32	27	KOR-L-18/15-SC	28,64
L	160	22	6	50,0	35,0	24	36	14	KOR-L-22/06-SC	29,84
L	160	22	8	50,0	35,0	24	36	17	KOR-L-22/08-SC	28,89
L	160	22	10	51,0	36,0	24	36	19	KOR-L-22/10-SC	29,81
L	160	22	12	51,0	36,0	24	36	22	KOR-L-22/12-SC	33,15
L	160	22	15	52,0	37,0	24	36	27	KOR-L-22/15-SC	37,10
L	160	22	18	53,0	36,5	27	36	32	KOR-L-22/18-SC	41,42
L	160	28	6	50,0	35,0	30	41	14	KOR-L-28/06-SC	39,49
L	160	28	8	50,0	35,0	30	41	17	KOR-L-28/08-SC	41,30
L	160	28	10	51,0	36,0	30	41	19	KOR-L-28/10-SC	42,58
L	160	28	12	51,0	36,0	30	41	22	KOR-L-28/12-SC	45,00
L	160	28	15	52,0	37,0	30	41	27	KOR-L-28/15-SC	46,16
L	160	28	18	54,0	37,5	30	41	32	KOR-L-28/18-SC	51,45
L	160	28	22	55,5	39,0	30	41	36	KOR-L-28/22-SC	54,63
L	160	35	6	58,0	43,0	36	50	14	KOR-L-35/06-SC	60,79
L	160	35	8	58,0	43,0	36	50	17	KOR-L-35/08-SC	61,43
L	160	35	10	59,0	44,0	36	50	19	KOR-L-35/10-SC	62,96
L	160	35	12	59,0	44,0	36	50	22	KOR-L-35/12-SC	63,08
L	160	35	15	60,0	45,0	36	50	27	KOR-L-35/15-SC	66,16
L	160	35	18	61,0	44,5	36	50	32	KOR-L-35/18-SC	69,27
L	160	35	22	63,0	46,5	36	50	36	KOR-L-35/22-SC	69,39
L	160	35	28	63,0	46,5	41	50	41	KOR-L-35/28-SC	72,19
L	160	42	6	59,0	44,0	36	60	14	KOR-L-42/06-SC	*
L	160	42	8	59,0	44,0	46	60	17	KOR-L-42/08-SC	*
L	160	42	10	60,0	45,0	46	60	19	KOR-L-42/10-SC	78,90
L	160	42	12	60,0	45,0	46	60	22	KOR-L-42/12-SC	81,57
L	160	42	15	61,0	46,0	46	60	27	KOR-L-42/15-SC	84,65
L	160	42	18	59,0	44,0	46	60	32	KOR-L-42/18-SC	85,21
L	160	42	22	63,0	46,5	46	60	36	KOR-L-42/22-SC	87,89
L	160	42	28	64,0	47,5	46	60	41	KOR-L-42/28-SC	90,68
L	160	42	35	69,0	47,5	46	60	50	KOR-L-42/35-SC	97,52



Anschluss D1 ist vormontiert. Die Fertigmontage erfolgt im Stutzen mit ca. 1/2 Umdrehung der Überwurfmutter über den Punkt des deutlich spürbaren Kraftanstieges.

Port D1 is pre-assembled. Final assembly in appropriate body with approx. 1/2 turn beyond the point of clearly perceptible resistance.

Reihe Series	Druck Pressure PN	Rohr A.D. Tube O.D. D1	Rohr A.D. Tube O.D. D2	Ca. Maße Approx. Dimensions				Bestellzeichen Order-Code OMD	Brutto-Preis Gross-Price Euro (€)
LL	100	6	4					KOR-LL-06/04-OMD	6,20
L	315	8	6					KOR-L-08/06-OMD	10,17
L	315	10	6					KOR-L-10/06-OMD	10,65
L	315	10	8					KOR-L-10/08-OMD	10,95
L	315	12	6					KOR-L-12/06-OMD	15,02
L	315	12	8					KOR-L-12/08-OMD	15,56
L	315	12	10					KOR-L-12/10-OMD	15,35
L	315	15	6					KOR-L-15/06-OMD	17,02
L	315	15	8					KOR-L-15/08-OMD	16,94
L	315	15	10					KOR-L-15/10-OMD	16,89
L	315	15	12					KOR-L-15/12-OMD	17,07
L	315	18	6					KOR-L-18/06-OMD	21,47
L	315	18	8					KOR-L-18/08-OMD	18,80
L	315	18	10					KOR-L-18/10-OMD	18,70
L	315	18	12					KOR-L-18/12-OMD	20,65
L	315	18	15					KOR-L-18/15-OMD	20,78
L	160	22	6					KOR-L-22/06-OMD	25,45
L	160	22	8					KOR-L-22/08-OMD	23,89
L	160	22	10					KOR-L-22/10-OMD	24,25
L	160	22	12					KOR-L-22/12-OMD	26,94
L	160	22	15					KOR-L-22/15-OMD	29,12
L	160	22	18					KOR-L-22/18-OMD	29,40
L	160	28	6					KOR-L-28/06-OMD	34,86
L	160	28	8					KOR-L-28/08-OMD	36,06
L	160	28	10					KOR-L-28/10-OMD	36,78
L	160	28	12					KOR-L-28/12-OMD	38,55
L	160	28	15					KOR-L-28/15-OMD	37,94
L	160	28	18					KOR-L-28/18-OMD	39,19
L	160	28	22					KOR-L-28/22-OMD	40,56
L	160	35	6					KOR-L-35/06-OMD	54,44
L	160	35	8					KOR-L-35/08-OMD	54,47
L	160	35	10					KOR-L-35/10-OMD	55,44
L	160	35	12					KOR-L-35/12-OMD	54,91
L	160	35	15					KOR-L-35/15-OMD	56,22
L	160	35	18					KOR-L-35/18-OMD	55,29
L	160	35	22					KOR-L-35/22-OMD	53,60
L	160	35	28					KOR-L-35/28-OMD	51,62
L	160	42	6					KOR-L-42/06-OMD	*
L	160	42	8					KOR-L-42/08-OMD	*
L	160	42	10					KOR-L-42/10-OMD	70,78
L	160	42	12					KOR-L-42/12-OMD	72,80
L	160	42	15					KOR-L-42/15-OMD	74,11
L	160	42	18					KOR-L-42/18-OMD	70,63
L	160	42	22					KOR-L-42/22-OMD	71,50
L	160	42	28					KOR-L-42/28-OMD	69,51
L	160	42	35					KOR-L-42/35-OMD	68,37

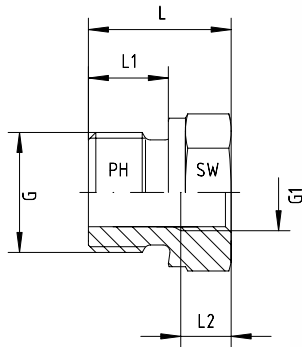

Form A

Beide Gewinde: Whitworth-Rohrgewinde - Zylindrisch -
DIN / ISO 228
Abdichtung durch Dichtkante Form B

Both Threads: BSP - Parallel - DIN / ISO 228
Sealing by Sealing Shoulder Form B

Druck Pressure PN	Außengewinde Male Thread G	Innengewinde Female Thread G1	Ca. Maße Approx. Dimensions				Form Form	Bestellzeichen Order-Code	Brutto-Preis Gross-Price Euro (€)
			L	L1	L2	SW			
400	G 3/8"	G 1/8"	22,5	12,0	8,0	22	A	GRI-3/8" x 1/8"	12,58
400	G 1/2"	G 1/4"	24,0	14,0	12,0	27	A	GRI-1/2" x 1/4"	13,70
400	G 1/2"	G 1/8"	24,0	14,0	8,0	27	A	GRI-1/2" x 1/8"	13,93
400	G 3/4"	G 3/8"	26,0	16,0	13,0	32	A	GRI-3/4" x 3/8"	20,96
400	G 3/4"	G 1/4"	26,0	16,0	12,0	32	A	GRI-3/4" x 1/4"	20,96
400	G 3/4"	G 1/8"	26,0	16,0	8,0	32	A	GRI-3/4" x 1/8"	21,95
400	G 1"	G 1/2"	29,0	18,0	14,0	41	A	GRI-1" x 1/2"	28,12
400	G 1"	G 3/8"	29,0	18,0	12,0	41	A	GRI-1" x 3/8"	26,28
400	G 1"	G 1/4"	29,0	18,0	12,0	41	A	GRI-1" x 1/4"	25,85
250	G 1 1/4"	G 3/4"	32,0	20,0	16,0	50	A	GRI-1 1/4" x 3/4"	52,41
250	G 1 1/4"	G 1/2"	32,0	20,0	14,0	50	A	GRI-1 1/4" x 1/2"	51,64
250	G 1 1/4"	G 3/8"	32,0	20,0	17,0	50	A	GRI-1 1/4" x 3/8"	52,80
250	G 1 1/2"	G 1"	36,0	22,0	18,0	55	A	GRI-1 1/2" x 1"	60,33
250	G 1 1/2"	G 3/4"	36,0	22,0	16,0	55	A	GRI-1 1/2" x 3/4"	58,29
250	G 1 1/2"	G 1/2"	36,0	22,0	14,0	55	A	GRI-1 1/2" x 1/2"	57,27
250	G 2"	G 1 1/2"	42,0	22,5	18,5	70	A	GRI-2" x 1 1/2"	125,27
250	G 2"	G 1 1/4"	42,0	22,5	18,5	70	A	GRI-2" x 1 1/4"	125,27
250	G 2"	G 1"	42,0	22,5	18,5	70	A	GRI-2" x 1"	125,27
250	G 2"	G 3/4"	42,0	22,5	16,0	70	A	GRI-2" x 3/4"	130,38
250	G 2"	G 1/2"	41,5	22,5	16,0	70	A	GRI-2" x 1/2"	130,38

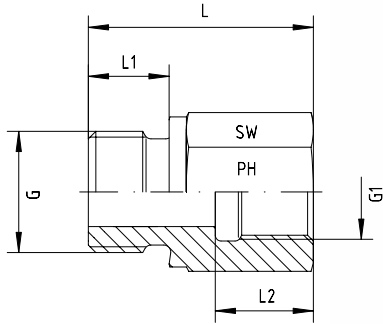

Form B

Beide Gewinde: Whitworth-Rohrgewinde - Zylindrisch -
DIN / ISO 228
Abdichtung durch Dichtkante Form B

Both Threads: BSP - Parallel - DIN / ISO 228
Sealing by Sealing Shoulder Form B

Druck Pressure PN	Außengewinde Male Thread G	Innengewinde Female Thread G1	Ca. Maße Approx. Dimensions				Form Form	Bestellzeichen Order-Code	Brutto-Preis Gross-Price Euro (€)
			L	L1	L2	SW			
							GRI-1/8" x 1/2"	15,88	
630	G 1/8"	G 3/8"	32,0	8,0	17,0	24	B	GRI-1/8" x 3/8"	12,78
630	G 1/8"	G 1/4"	31,0	8,0	17,0	19	B	GRI-1/8" x 1/4"	10,84
630	G 1/4"	G 3/4"	43,0	12,0	22,0	36	B	GRI-1/4" x 3/4"	26,69
630	G 1/4"	G 1/2"	40,0	12,0	20,0	27	B	GRI-1/4" x 1/2"	15,88
630	G 1/4"	G 3/8"	36,0	12,0	17,0	24	B	GRI-1/4" x 3/8"	14,57
630	G 1/4"	G 1/8"	28,0	12,0	12,0	19	B	GRI-1/4" x 1/8"	11,15
400	G 3/8"	G 1"	46,5	12,0	24,5	41	B	GRI-3/8" x 1"	31,70
400	G 3/8"	G 3/4"	44,0	12,0	22,0	36	B	GRI-3/8" x 3/4"	24,29
400	G 3/8"	G 1/2"	41,0	12,0	20,0	27	B	GRI-3/8" x 1/2"	15,85
400	G 3/8"	G 1/4"	36,0	12,0	17,0	22	B	GRI-3/8" x 1/4"	13,81
250	G 1/2"	G 1 1/4"	53,0	14,0	26,5	55	B	GRI-1/2" x 1 1/4"	98,17
400	G 1/2"	G 1"	49,0	14,0	24,5	41	B	GRI-1/2" x 1"	31,70
400	G 1/2"	G 3/4"	46,0	14,0	22,0	36	B	GRI-1/2" x 3/4"	23,26
400	G 1/2"	G 3/8"	36,0	14,0	17,0	27	B	GRI-1/2" x 3/8"	16,11
250	G 3/4"	G 1 1/2"	57,0	16,0	28,5	60	B	GRI-3/4" x 1 1/2"	120,67
250	G 3/4"	G 1 1/4"	55,0	16,0	26,5	55	B	GRI-3/4" x 1 1/4"	97,15
400	G 3/4"	G 1"	51,0	16,0	24,5	41	B	GRI-3/4" x 1"	35,74
400	G 3/4"	G 1/2"	41,0	16,0	20,0	32	B	GRI-3/4" x 1/2"	26,59
250	G 1"	G 1 1/2"	59,0	18,0	28,5	60	B	GRI-1" x 1 1/2"	117,60
250	G 1"	G 1 1/4"	57,0	18,0	26,5	55	B	GRI-1" x 1 1/4"	95,51
400	G 1"	G 3/4"	47,0	18,0	22,0	41	B	GRI-1" x 3/4"	33,23
250	G 1 1/4"	G 1 1/2"	60,0	20,0	28,5	60	B	GRI-1 1/4" x 1 1/2"	116,83
250	G 1 1/4"	G 1"	52,0	20,0	24,5	50	B	GRI-1 1/4" x 1"	60,84
250	G 1 1/2"	G 1 1/4"	58,0	22,0	26,5	55	B	GRI-1 1/2" x 1 1/4"	91,37

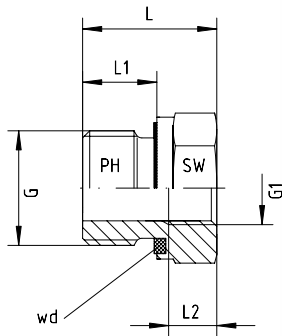

Form A

Beide Gewinde: Whitworth-Rohrgewinde - Zylindrisch - DIN / ISO 228

wd = Abdichtung durch Profildichtung - Viton

Both Threads: BSP - Parallel - DIN / ISO 228

wd = Sealing by an Elastomer Profiled Ring - Viton

Druck Pressure PN	Außengewinde Male Thread G	Innengewinde Female Thread G1	Ca. Maße Approx. Dimensions				Form Form	Bestellzeichen Order-Code	Brutto-Preis Gross-Price Euro (€)
			L	L1	L2	SW			
630	G 3/8"	G 1/8"	22,5	12,0	8,0	22	A	GRI-3/8"-wd x 1/8"	13,55
630	G 1/2"	G 1/4"	24,0	14,0	12,0	27	A	GRI-1/2"-wd x 1/4"	17,41
630	G 1/2"	G 1/8"	24,0	14,0	8,0	27	A	GRI-1/2"-wd x 1/8"	16,92
400	G 3/4"	G 3/8"	26,0	16,0	13,0	32	A	GRI-3/4"-wd x 3/8"	26,08
400	G 3/4"	G 1/4"	26,0	16,0	12,0	32	A	GRI-3/4"-wd x 1/4"	26,08
400	G 3/4"	G 1/8"	26,0	16,0	8,0	32	A	GRI-3/4"-wd x 1/8"	27,15
400	G 1"	G 1/2"	29,0	18,0	14,0	41	A	GRI-1"-wd x 1/2"	32,03
400	G 1"	G 3/8"	29,0	18,0	12,0	41	A	GRI-1"-wd x 3/8"	30,09
400	G 1"	G 1/4"	29,0	18,0	12,0	41	A	GRI-1"-wd x 1/4"	29,63
400	G 1 1/4"	G 3/4"	32,0	20,0	16,0	50	A	GRI-1 1/4"-wd x 3/4"	58,03
400	G 1 1/4"	G 1/2"	32,0	20,0	14,0	60	A	GRI-1 1/4"-wd x 1/2"	57,46
400	G 1 1/4"	G 3/8"	32,0	20,0	17,0	50	A	GRI-1 1/4"-wd x 3/8"	58,70
315	G 1 1/2"	G 1"	36,0	22,0	18,0	55	A	GRI-1 1/2"-wd x 1"	65,45
315	G 1 1/2"	G 3/4"	36,0	22,0	16,0	55	A	GRI-1 1/2"-wd x 3/4"	61,36
315	G 1 1/2"	G 1/2"	36,0	22,0	14,0	55	A	GRI-1 1/2"-wd x 1/2"	61,36
250	G 2"	G 1 1/2"	42,0	22,5	18,5	70	A	GRI-2"-wd x 1 1/2"	159,00
250	G 2"	G 1 1/4"	42,0	22,5	18,5	70	A	GRI-2"-wd x 1 1/4"	159,00
250	G 2"	G 1"	42,0	22,5	18,5	70	A	GRI-2"-wd x 1"	159,00
250	G 2"	G 3/4"	42,0	22,5	16,0	70	A	GRI-2"-wd x 3/4"	159,00
250	G 2"	G 1/2"	41,5	22,5	16,0	70	A	GRI-2"-wd x 1/2"	159,00

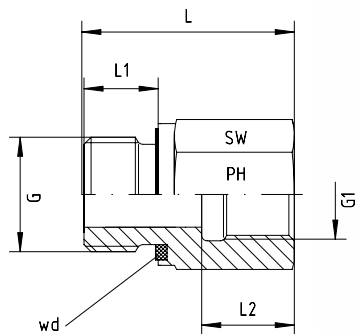

Form B

Beide Gewinde: Whitworth-Rohrgewinde - Zylindrisch - DIN / ISO 228

wd = Abdichtung durch Profildichtung - Viton

Both Threads: BSP - Parallel - DIN / ISO 228

wd = Sealing by an Elastomer Profiled Ring - Viton

Druck Pressure PN	Außengewinde Male Thread G	Innengewinde Female Thread G1	Ca. Maße Approx. Dimensions				Form Form	Bestellzeichen Order-Code	Brutto-Preis Gross-Price Euro (€)
			L	L1	L2	SW			
								GRI-1/8"-wd x 1/2"	19,80
630	G 1/8"	G 3/8"	32,0	8,0	17,0	24	B	GRI-1/8"-wd x 3/8"	15,34
630	G 1/8"	G 1/4"	31,0	8,0	17,0	19	B	GRI-1/8"-wd x 1/4"	13,55
400	G 1/4"	G 1"	46,0	12,0	24,5	41	B	GRI-1/4"-wd x 1"	56,00
630	G 1/4"	G 3/4"	43,0	12,0	22,0	36	B	GRI-1/4"-wd x 3/4"	30,24
630	G 1/4"	G 1/2"	40,0	12,0	20,0	27	B	GRI-1/4"-wd x 1/2"	18,10
630	G 1/4"	G 3/8"	36,0	12,0	17,0	24	B	GRI-1/4"-wd x 3/8"	16,96
630	G 1/4"	G 1/8"	28,0	12,0	12,0	19	B	GRI-1/4"-wd x 1/8"	13,41
400	G 3/8"	G 1"	46,5	12,0	24,5	41	B	GRI-3/8"-wd x 1"	35,71
400	G 3/8"	G 3/4"	44,0	12,0	22,0	36	B	GRI-3/8"-wd x 3/4"	16,19
630	G 3/8"	G 1/2"	41,0	12,0	20,0	27	B	GRI-3/8"-wd x 1/2"	18,15
630	G 3/8"	G 1/4"	36,0	12,0	17,0	22	B	GRI-3/8"-wd x 1/4"	16,19
400	G 1/2"	G 1 1/4"	53,0	14,0	26,5	55	B	GRI-1/2"-wd x 1 1/4"	104,82
400	G 1/2"	G 1"	49,0	14,0	24,5	41	B	GRI-1/2"-wd x 1"	35,71
400	G 1/2"	G 3/4"	46,0	14,0	22,0	36	B	GRI-1/2"-wd x 3/4"	23,78
630	G 1/2"	G 3/8"	36,0	14,0	17,0	27	B	GRI-1/2"-wd x 3/8"	20,93
315	G 3/4"	G 1 1/2"	57,0	16,0	28,5	60	B	GRI-3/4"-wd x 1 1/2"	125,27
400	G 3/4"	G 1 1/4"	55,0	16,0	26,5	55	B	GRI-3/4"-wd x 1 1/4"	102,26
400	G 3/4"	G 1"	51,0	16,0	24,5	41	B	GRI-3/4"-wd x 1"	38,09
400	G 3/4"	G 1/2"	41,0	16,0	20,0	32	B	GRI-3/4"-wd x 1/2"	28,89
315	G 1"	G 1 1/2"	59,0	18,0	28,5	60	B	GRI-1"-wd x 1 1/2"	125,27
400	G 1"	G 1 1/4"	57,0	18,0	26,5	55	B	GRI-1"-wd x 1 1/4"	100,73
400	G 1"	G 3/4"	47,0	18,0	22,0	41	B	GRI-1"-wd x 3/4"	36,05
315	G 1 1/4"	G 1 1/2"	60,0	20,0	28,5	60	B	GRI-1 1/4"-wd x 1 1/2"	123,99
400	G 1 1/4"	G 1"	52,0	20,0	24,5	50	B	GRI-1 1/4"-wd x 1"	65,91
315	G 1 1/2"	G 1 1/4"	58,0	22,0	26,5	55	B	GRI-1 1/2"-wd x 1 1/4"	97,15

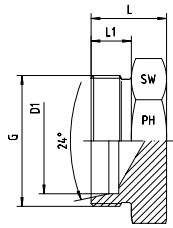

Mit 24°-Innenkonus für Rohrenden
Bohrungsform W DIN 3861

With 24°-Cone for Tube Ends
Type of Port End W DIN 3861

Reihe Series	Druck Pressure PN	Rohr A.D. Tube O.D. D1	Gewinde Thread G	Ca. Maße Approx. Dimensions			Bestellzeichen Order-Code	Brutto-Preis Gross-Price Euro (€)
				L	L1	SW		
L	500	6	M 12 x 1,5	14	10	12	XROV-L-06	4,63
L	500	8	M 14 x 1,5	15	10	14	XROV-L-08	5,85
L	500	10	M 16 x 1,5	16	11	17	XROV-L-10	7,13
L	400	12	M 18 x 1,5	17	11	19	XROV-L-12	8,54
L	400	15	M 22 x 1,5	18	12	24	XROV-L-15	14,16
L	400	18	M 26 x 1,5	19	12	27	XROV-L-18	16,92
L	250	22	M 30 x 2	21	14	32	XROV-L-22	22,04
L	250	28	M 36 x 2	22	14	41	XROV-L-28	34,92
L	250	35	M 45 x 2	25	16	46	XROV-L-35	56,09
L	250	42	M 52 x 2	27	16	55	XROV-L-42	65,29

Reihe Series	Druck Pressure PN	Rohr A.D. Tube O.D. D1	Gewinde Thread G	Ca. Maße Approx. Dimensions			Bestellzeichen Order-Code	Brutto-Preis Gross-Price Euro (€)
				L	L1	SW		
S	800	6	M 14 x 1,5	18	12	14	XROV-S-06	5,78
S	800	8	M 16 x 1,5	20	12	17	XROV-S-08	7,06
S	800	10	M 18 x 1,5	20	12	19	XROV-S-10	8,79
S	630	12	M 20 x 1,5	22	12	22	XROV-S-12	10,00
S	630	14	M 22 x 1,5	24	14	24	XROV-S-14	12,88
S	630	16	M 24 x 1,5	24	14	27	XROV-S-16	17,36
S	420	20	M 30 x 2	28	16	32	XROV-S-20	23,32
S	420	25	M 36 x 2	32	18	41	XROV-S-25	39,96
S	420	30	M 42 x 2	34	20	46	XROV-S-30	56,60
S	420	38	M 52 x 2	39	22	55	XROV-S-38	72,14

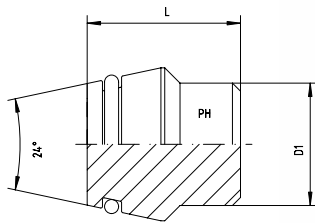

Mit O-Ring - NBR
Für Bohrungsform W DIN 3861

With O-ring - NBR
For Port End W DIN 3861

Reihe Series	Druck Pressure PN	Rohr A.D. Tube O.D. D1	L	Bestellzeichen Order-Code	Brutto-Preis Gross-Price Euro (€)
L	500	6	19,0	VKA-L-06	5,01
L	500	8	18,5	VKA-L-08	5,32
L	500	10	21,0	VKA-L-10	6,14
L	400	12	19,0	VKA-L-12	7,26
L	400	15	22,0	VKA-L-15	8,10
L	400	18	24,0	VKA-L-18	10,48
L	250	22	25,0	VKA-L-22	14,32
L	250	28	26,0	VKA-L-28	21,01
L	250	35	24,0	VKA-L-35	36,51
L	250	42	27,0	VKA-L-42	45,63

Reihe Series	Druck Pressure PN	Rohr A.D. Tube O.D. D1	L	Bestellzeichen Order-Code	Brutto-Preis Gross-Price Euro (€)
S	800	6	19,0	VKA-S-06	5,01
S	800	8	18,5	VKA-S-08	5,32
S	800	10	21,0	VKA-S-10	6,14
S	630	12	19,0	VKA-S-12	7,26
S	630	14	23,5	VKA-S-14	8,18
S	630	16	20,0	VKA-S-16	10,23
S	420	20	28,0	VKA-S-20	13,70
S	420	25	28,0	VKA-S-25	18,00
S	420	30	30,5	VKA-S-30	29,20
S	420	38	40,0	VKA-S-38	43,20

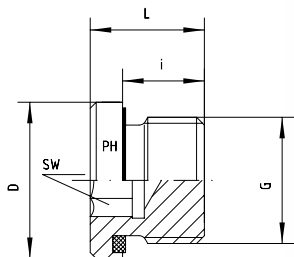

Mit Innensechskant und Weichdichtung - Viton - wd

With Internal Hex and Soft Seal - Viton - wd

Druck Pressure PN	Metrisches Feingewinde - Zylindrisch Thread: Metric - Parallel G	Ca. Maße Approx. Dimensions				Bestellzeichen Order-Code	Brutto-Preis Gross-Price Euro (€)
		D	L	i	SW		
400	M 8 x 1	12	12,0	8	4	VST-M 8x1-wd	15,20
400	M 10 x 1	14	12,0	8	5	VST-M 10x1-wd	8,08
400	M 12 x 1,5	17	17,0	12	6	VST-M 12x1,5-wd	8,59
400	M 14 x 1,5	19	17,0	12	6	VST-M 14x1,5-wd	9,15
400	M 16 x 1,5	22	17,0	12	8	VST-M 16x1,5-wd	9,87
400	M 18 x 1,5	24	17,0	12	8	VST-M 18x1,5-wd	10,53
400	M 20 x 1,5	26	19,0	14	10	VST-M 20x1,5-wd	12,27
400	M 22 x 1,5	27	19,0	14	10	VST-M 22x1,5-wd	13,65
400	M 26 x 1,5	32	21,0	16	12	VST-M 26x1,5-wd	18,20
400	M 27 x 2	32	21,0	16	12	VST-M 27x2-wd	19,53
400	M 33 x 2	40	22,5	16	17	VST-M 33x2-wd	29,35
315	M 42 x 2	50	22,5	16	22	VST-M 42x2-wd	37,84
315	M 48 x 2	55	22,5	16	24	VST-M 48x2-wd	60,84

Druck Pressure PN	Metrisches Feingewinde - Zylindrisch Thread: Metric - Parallel G	Ca. Maße Approx. Dimensions				Bestellzeichen Order-Code	Brutto-Preis Gross-Price Euro (€)
		D	L	i	SW		
400	1/8"	14	12,0	8	5	VST-R 1/8"-wd	7,26
400	1/4"	19	17,0	12	6	VST-R 1/4"-wd	8,18
400	3/8"	22	17,0	12	8	VST-R 3/8"-wd	9,46
400	1/2"	27	19,0	14	10	VST-R 1/2"-wd	12,53
400	3/4"	32	21,0	16	12	VST-R 3/4"-wd	17,13
400	1"	40	22,5	16	17	VST-R 1"-wd	26,84
315	1 1/4"	50	22,5	16	22	VST-R 1 1/4"-wd	31,96
315	1 1/2"	55	22,5	16	24	VST-R 1 1/2"-wd	34,77

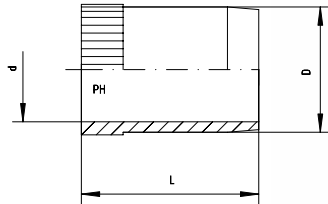

Für dünnwandige Metallrohre
Andere Größen auf Anfrage!

For thin-walled Metal Tubes
Other sizes on request!

Rohr-Innendurchmesser Tube Inside	Ca. Maße Approx. Dimensions			Bestellzeichen Order-Code	Brutto-Preis Gross-Price Euro (€)
	D	d	L		
4	3,8	2,5	17,0	VSHü-04	1,82
5	4,8	3,5	17,0	VSHü-05	1,94
6	5,8	4,5	14,0	VSHü-06	2,05
7	6,8	5,5	17,0	VSHü-07	2,20
8	7,8	6,5	15,5	VSHü-08	2,28
9	8,8	7,5	17,0	VSHü-09	2,43
10	9,8	8,5	15,5	VSHü-10	2,66
11	10,8	9,5	17,0	VSHü-11	2,68
12	11,8	10,5	17,0	VSHü-12	2,63
13	12,8	11,5	17,0	VSHü-13	3,73
14	13,8	12,0	17,0	VSHü-14	3,12
15	14,8	13,0	18,0	VSHü-15	3,86
16	15,8	14,0	18,0	VSHü-16	3,35
17	16,8	15,0	20,0	VSHü-17	5,04
18	17,8	16,0	20,0	VSHü-18	4,63
19	18,8	17,0	20,0	VSHü-19	5,04
20	19,8	18,0	20,0	VSHü-20	4,63
21	20,8	19,0	21,5	VSHü-21	*
22	21,8	20,0	24,0	VSHü-22	6,31
23	22,8	21,0	24,0	VSHü-23	6,31
24	23,8	22,0	23,5	VSHü-24	6,95
25	24,8	23,0	23,5	VSHü-25	6,72
26	25,8	24,0	23,5	VSHü-26	6,65
30	29,8	27,8	26,5	VSHü-30	7,64
31	30,8	28,0	26,5	VSHü-31	7,23
32	31,8	29,5	26,5	VSHü-32	8,08
33	32,8	30,0	26,5	VSHü-33	7,49
38	37,8	35,0	26,5	VSHü-38	8,00

Für Schottverschraubungen

For Bulkhead Couplings

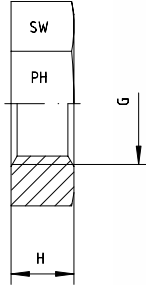

Gewinde Thread G	H	SW	Bestellzeichen Order-Code	Brutto-Preis Gross-Price Euro (€)
M 12 x 1,5 = 06-L	6	17	GM-12x1,5	1,71
M 14 x 1,5 = 08-L + 06-S	6	19	GM-14x1,5	1,99
M 16 x 1,5 = 10-L + 08-S	6	22	GM-16x1,5	2,66
M 18 x 1,5 = 12-L + 10-S	6	24	GM-18x1,5	2,74
M 20 x 1,5 = 12-S	6	27	GM-20x1,5	3,30
M 22 x 1,5 = 15-L + 14-S	7	30	GM-22x1,5	4,53
M 24 x 1,5 = 16-S	7	32	GM-24x1,5	6,42
M 26 x 1,5 = 18-L	8	36	GM-26x1,5	10,15
M 30 x 2 = 22-L + 20-S	8	41	GM-30x2	12,63
M 36 x 2 = 28-L + 25-S	9	46	GM-36x2	18,33
M 42 x 2 = 30-S	9	50	GM-42x2	20,86
M 45 x 2 = 35-L	9	55	GM-45x2	25,39
M 52 x 2 = 42-L + 38-S	10	65	GM-52x2	31,55

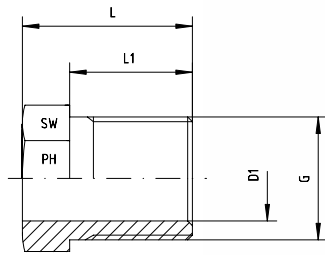

Einschraubgewinde: Metrisches Feingewinde - Zylindrisch

Thread: Metric - Parallel

Reihe Series	Druck Pressure PN	Rohr A.D. Tube O.D. D1 +Tol.	Gewinde Thread G	Ca. Maße Approx. Dimensions			DIN 3871	Bestellzeichen Order-Code	Brutto-Preis Gross-Price Euro (€)
				L	L1	SW			
LL	100	4	M 8 x 1	12	8,0	8	ALL 4	ÜWS-M 8x1	11,90
LL	100	6	M 10 x 1	13	9,0	10	ALL 6	ÜWS-M 10x1	*
LL	100	8	M 12 x 1	14	9,5	12	ALL 8	ÜWS-M 12x1	*
L	250	6	M 12 x 1,5	16	11,5	12	AL 6	ÜWS-M 12x1,5	*
L	250	8	M 14 x 1,5	16	11,5	14	AL 8	ÜWS-M 14x1,5	*
L	250	10	M 16 x 1,5	17	11,5	17	AL 10	ÜWS-M 16x1,5	15,80
L	250	12	M 18 x 1,5	18	12,0	19	AL 12	ÜWS-M 18x1,5	15,90

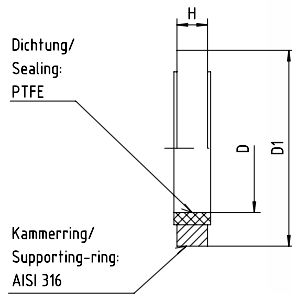

Für Schwenkverschraubungen WHV / THV
Für Einschraublöcher mit breiter Ausdehnung

For Banjo Couplings WHV / THV
For wide Spot Faces of Ports

Zu verwenden für: To use for: WHV / THV	Gewinde Thread	Ca. Maße Approx. Dimensions			Bestellzeichen Order-Code	Brutto-Preis Gross-Price Euro (€)
		D	D1	H		
6 - LR KDR	G 1/8"	10,0	17,0	2,5	KDR-1/8"	20,50
8 - LR / 6 - SR KDR	G 1/4"	13,5	22,0	3,0	KDR-1/4"	21,45
10 - LR / 8 - SR KDR	G 1/4"	13,5	22,0	3,0	KDR-1/4"	21,45
12 - LR / 10 - SR KDR	G 3/8"	17,1	27,0	3,0	KDR-3/8"	29,30
12 - SR KDR	G 3/8"	17,1	27,0	3,0	KDR-3/8"	29,30
15 - LR / 14 - SR KDR	G 1/2"	21,4	32,0	4,5	KDR-1/2"	34,85
18 - LR / 16 - SR KDR	G 1/2"	21,4	32,0	4,5	KDR-1/2"	34,85
22 - LR / 20 - SR KDR	G 3/4"	26,8	41,0	3,5	KDR-3/4"	57,50
28 - LR / 25 - SR KDR	G 1"	33,5	46,0	3,5	KDR-1/33"	81,50
35 - LR / 30 - SR KDR	G 1 1/4"	42,4	57,0	3,5	KDR-1 1/4"/42	83,50
42 - LR / 38 - SR KDR	G 1 1/2"	48,4	64,0	3,5	KDR-1 1/2"/48	111,00
6 - LM KDR	M 10 x 1	10,3	17,0	2,5	KDR-10x1	*
8 - LM / 6 - SM KDR	M 12 x 1,5	12,3	22,0	3,0	KDR-12x1,5	*
10 - LM / 8 - SM KDR	M 14 x 1,5	14,3	22,5	3,0	KDR-14x1,5	*
12 - LM / 10 - SM KDR	M 16 x 1,5	16,4	27,0	3,0	KDR-16x1,5	*
15 - LM / 12 - SM KDR	M 18 x 1,5	18,4	29,0	3,0	KDR-18x1,5	*
14 - SM KDR	M 20 x 1,5	20,4	32,0	3,0	KDR-20x1,5	*
18 - LM / 16 - SM KDR	M 22 x 1,5	22,4	32,0	4,5	KDR-22x1,5	*
22 - LM	M 26 x 1,5	26,4	41,0	3,5	KDR-26x1,5	*
20 - SM KDR	M 27 x 2	27,4	41,0	3,5	KDR-27x2	*
28 - LM / 25 - SM KDR	M 33 x 2	33,5	46,0	3,5	KDR-33x2/1"	81,50
35 - LM / 30 - SM KDR	M 42 x 2	42,4	57,0	3,5	KDR-42x2/1 1/4"	83,50
42 - LM / 38 - SM KDR	M 48 x 2	48,4	64,0	3,5	KDR-48x2/1 1/2"	111,00

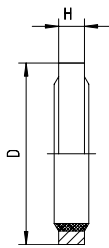

Für Einschraubgewinde bzw. für Einschraublöcher mit
breiter oder schmaler Ausdrehung

V = Viton
P = Perbunan

For Port Threads or for wide and small Spot Faces of
Ports

V = Viton
P = Perbunan

Zu verwenden für: To use for:		Ca. Maße Approx. Dimensions		Bestellzeichen Order-Code	Brutto-Preis Gross-Price Euro (€)
Gewinde / Thread		D	H		
M 10 x 1	G 1/8"	16,0	2,5	KDW-10-V	11,22
M 12 x 1,5		18,0	3,0	KDW-12-V	11,22
	G 1/4"	20,0	3,0	KDW-14-V	11,22
M 14 x 1,5	G 1/4"	20,0	3,0	KDW-14-V	11,22
M 14 x 1,5	G 1/4"	20,0	3,0	KDW-14-V	11,22
M 16 x 1,5	G 3/8"	24,0	3,0	KDW-16-V	11,72
M 16 x 1,5	G 3/8"	24,0	3,0	KDW-16-V	11,72
M 18 x 1,5		23,9	3,0	KDW-18-V	12,87
	G 1/2"	30,0	4,5	KDW-22-V	12,87
M 22 x 1,5	G 1/2"	30,0	4,5	KDW-22-V	12,87
M 22 x 1,5	G 1/2"	30,0	4,5	KDW-22-V	12,87
M 26 x 1,5		35,0	3,5	KDW-26-V	*
M 27 x 2	G 3/4"	38,0	3,5	KDW-27-V	14,35
	G 3/4"	38,0	3,5	KDW-27-V	14,35
M 33 x 2	G 1"	42,0	3,5	KDW-33-V	29,00
M 33 x 2	G 1"	42,0	3,5	KDW-33-V	29,00
M 42 x 2	G 1 1/4"	49,9	3,5	KDW-42-V	31,00
M 42 x 2	G 1 1/4"	49,9	3,5	KDW-42-V	31,00
M 48 x 2	G 1 1/2"	60,0	3,5	KDW-48-V	37,12
M 48 x 2	G 1 1/2"	60,0	3,5	KDW-48-V	37,12

Zu verwenden für: To use for:		Ca. Maße Approx. Dimensions		Bestellzeichen Order-Code	Brutto-Preis Gross-Price Euro (€)
Gewinde / Thread		D	H		
M 10 x 1	G 1/8"	16,0	2,5	KDW-10-P	4,62
M 12 x 1,5		18,0	3,0	KDW-12-P	*
	G 1/4"	20,0	3,0	KDW-14-P	4,62
M 14 x 1,5	G 1/4"	20,0	3,0	KDW-14-P	4,62
M 14 x 1,5	G 1/4"	20,0	3,0	KDW-14-P	4,62
M 16 x 1,5	G 3/8"	24,0	3,0	KDW-16-P	5,28
M 16 x 1,5	G 3/8"	24,0	3,0	KDW-16-P	5,28
M 18 x 1,5		23,9	3,0	KDW-18-P	*
	G 1/2"	30,0	4,5	KDW-22-P	6,27
M 22 x 1,5	G 1/2"	30,0	4,5	KDW-22-P	6,27
M 22 x 1,5	G 1/2"	30,0	4,5	KDW-22-P	6,27
M 26 x 1,5		35,0	3,5	KDW-26-P	*
M 27 x 2	G 3/4"	38,0	3,5	KDW-27-P	13,04
	G 3/4"	38,0	3,5	KDW-27-P	13,04
M 33 x 2	G 1"	42,0	3,5	KDW-33-P	19,97
M 33 x 2	G 1"	42,0	3,5	KDW-33-P	19,97
M 42 x 2	G 1 1/4"	49,9	3,5	KDW-42-P	29,37
M 42 x 2	G 1 1/4"	49,9	3,5	KDW-42-P	29,37
M 48 x 2	G 1 1/2"	60,0	3,5	KDW-48-P	35,80
M 48 x 2	G 1 1/2"	60,0	3,5	KDW-48-P	35,80

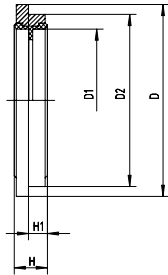

Für Schwenkverschraubungen WHV / THV
Für Einschraublöcher mit breiter oder schmaler Ausdehnung
Viton-Dichtung

For Banjo Couplings WHV / THV
For wide and small Spot Faces of Ports
Viton Seal

Zu verwenden für: To use for: WHV / THV	Gewinde Thread		Ca. Maße Approx. Dimensions					Bestellzeichen Order-Code	Brutto-Preis Gross-Price Euro (€)
			D	D1	D2	H	H1		
6 - LM / LR	M 10 x 1	G 1/8"	16,0	10,3	14,9	2,5	1,1	WDS-10	13,86
6 - SM / 8 - LM	M 12 x 1,5		18,0	12,3	17,0	3,0	1,6	WDS-12	33,39
6 - SR		G 1/4"	20,0	14,3	18,9	3,0	1,6	WDS-14	17,19
8 - LR / SR / SM	M 14 x 1,5	G 1/4"	20,0	14,3	18,9	3,0	1,6	WDS-14	17,19
10 - LM / LR	M 14 x 1,5	G 1/4"	20,0	14,3	18,9	3,0	1,6	WDS-14	17,19
10 - SR / SM	M 16 x 1,5	G 3/8"	24,0	17,0	21,9	3,0	2,1	WDS-16	19,26
12 - LR / LM / SR	M 16 x 1,5	G 3/8"	24,0	17,0	21,9	3,0	2,1	WDS-16	19,26
12 - SM / 15 - LM	M 18 x 1,5		23,9	18,3	23,9	3,0		WDS-18	20,43
15 - LR / 14 - SR		G 1/2"	30,0	22,3	26,9	4,5	2,6	WDS-22	25,74
16 - SR / 16 - SM	M 22 x 1,5	G 1/2"	30,0	22,3	26,9	4,5	2,6	WDS-22	25,74
18 - LR / 18 - LM	M 22 x 1,5	G 1/2"	30,0	22,3	26,9	4,5	2,6	WDS-22	25,74
22 - LM	M 26 x 1,5		35,0	26,3	31,9	3,5	2,6	WDS-26	33,39
20 - SR / 20 - SM	M 27 x 2	G 3/4"	38,0	27,3	32,9	3,5	2,6	WDS-27	41,58
22 - LR		G 3/4"	38,0	27,3	32,9	3,5	2,6	WDS-27	41,58
25 - SR / 25 - SM	M 33 x 2	G 1"	42,0	33,6	39,9	3,5	2,6	WDS-33	51,57
28 - LR / 28 - LM	M 33 x 2	G 1"	42,0	33,6	39,9	3,5	2,6	WDS-33	51,57
30 - SR / 30 - SM	M 42 x 2	G 1 1/4"	49,9	42,4	49,9	3,5		WDS-42	69,93
35 - LR / 35 - LM	M 42 x 2	G 1 1/4"	49,9	42,4	49,9	3,5		WDS-42	69,93
38 - SR / 38 - SM	M 48 x 2	G 1 1/2"	60,0	48,4	55,9	3,5	2,6	WDS-48	96,39
42 - LR / 42 - LM	M 48 x 2	G 1 1/2"	60,0	48,4	55,9	3,5	2,6	WDS-48	96,39

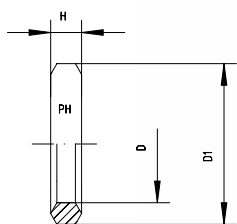

Für Schwenkverschraubungen WHV / THV
Mit Außengewinde

For Banjo Couplings WHV / THV
With External Thread

Gewinde Thread	Ca. Maße Approx. Dimensions			Bestellzeichen Order-Code	Brutto-Preis Gross-Price Euro (€)
	D	D1	H		
G 1/8"	9,8	14	2,5	DKR-G 1/8"	2,81
G 1/4"	13,3	18	3,0	DKR-G 1/4"	2,91
G 3/8"	16,8	22	3,0	DKR-G 3/8"	3,43
G 1/2"	21,1	26	4,5	DKR-G 1/2"	3,71
G 3/4"	27,1	32	4,0	DKR-G 3/4"	4,09
G 1"	33,4	39	4,0	DKR-G 1"	4,93
G 1 1/4"	42,1	49	4,0	DKR-G 1 1/4"	7,00
G 1 1/2"	48,1	55	4,0	DKR-G 1 1/2"	7,54
M 10 x 1	10,0	14	2,5	DKR-M 10x1	2,48
M 12 x 1,5	12,1	17	3,0	DKR-M 12x1,5	2,91
M 14 x 1,5	14,1	19	3,0	DKR-M 14x1,5	3,27
M 16 x 1,5	16,1	21	3,0	DKR-M 16x1,5	3,50
M 18 x 1,5	18,1	23	3,0	DKR-M 18x1,5	3,73
M 20 x 1,5	20,1	25	3,0	DKR-M 20x1,5	3,78
M 22 x 1,5	22,1	27	3,0	DKR-M 22x1,5	3,81
M 26 x 1,5	26,1	31	3,0	DKR-M 26x1,5	3,94
M 27 x 2	27,1	32	4,0	DKR-M 27x2	4,27
M 33 x 2	33,1	39	4,0	DKR-M 33x2	5,19
M 42 x 2	42,1	49	4,0	DKR-M 42x2	7,06
M 48 x 2	48,1	55	4,0	DKR-M 48x2	7,54

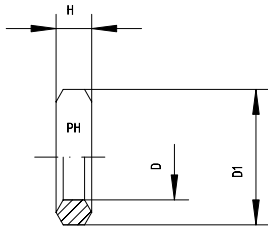

Für Innengewinde

For Internal Thread

Gewinde Thread	Ca. Maße Approx. Dimensions			Bestellzeichen Order-Code	Brutto-Preis Gross-Price Euro (€)
	D	D1	H		
G 1/4"	6	11,3	4,5	DKRi-G 1/4"	2,33
G 3/8"				DKRi-G 3/8"	*
G 1/2"	12	18,5	5,0	DKRi-G 1/2"	2,81
M 18 x 1,5				DKRi-M 18x1,5	*
M 20 x 1,5	12	17,5	5,0	DKRi-M 20x1,5	2,53

WEICHDICHTRINGE - WD

SOFT SEAL RINGS - WD



EDELSTAHL / STAINLESS STEEL
VERBINDUNGSTECHNIK
FLUID CONNECTORS

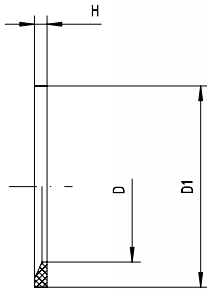

Nach DIN 3869
Aus FPM (Viton)
-20°C bis +200°C

To DIN 3869
FPM (Viton)
-20°C to +200°C

Gewinde Thread	Ca. Maße Approx. Dimensions			Bestellzeichen Order-Code	Brutto-Preis Gross-Price Euro (€)	
	D	D1	H			
M 8 x 1		6,5	9,9	1,0	WD-8x1	2,16
M 10 x 1	R 1/8"	8,4	11,9	1,0	WD-10x1/1/8"	2,17
M 12 x 1,5		9,8	14,4	1,5	WD-12x1,5	2,20
M 14 x 1,5	R 1/4"	11,6	16,5	1,5	WD-14x1,5/1/4"	2,20
M 16 x 1,5		13,8	18,9	1,5	WD-16x1,5	2,20
	R 3/8"	14,7	18,9	1,5	WD-3/8"	2,20
M 18 x 1,5		15,7	20,9	1,5	WD-18x1,5	2,20
M 20 x 1,5		17,8	22,9	1,5	WD-20x1,5	2,22
	R 1/2"	18,5	23,9	1,5	WD-1/2"	2,30
M 22 x 1,5		19,6	24,3	1,5	WD-22x1,5	2,05
M 26 x 1,5	R 3/4"	23,9	29,2	1,5	WD-26x1,5/3/4"	2,30
M 27 x 2	R 3/4"	23,9	29,2	1,5	WD-27x2/3/4"	2,30
M 33 x 2	R 1"	29,7	35,7	2,0	WD-33x2/1"	2,51
M 42 x 2	R 1 1/4"	38,8	45,8	2,0	WD-42x2/1 1/4"	2,74
M 48 x 2	R 1 1/2"	44,7	50,7	2,0	WD-48x2/1 1/2"	2,76

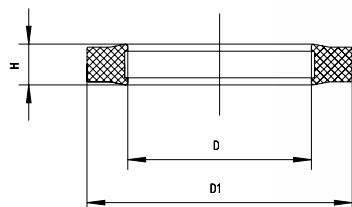

Aus Polyurethane
-40°C bis +100°C
Für Flansch SAE J 518 / ISO 6162

Made from Polyurethane
-40°C to +100°C
For Flange SAE J 518 / ISO 6162

Flanschgröße Flange Dimensions 3000 + 6000 P.S.I.	Druck Pressure PN	Ca. Maße Approx. Dimensions			Bestellzeichen Order-Code	Brutto-Preis Gross-Price Euro (€)
		D	D1	H		
1/2"	420	17,0	25,4	3,5	PU-1/2"	3,30
3/4"	420	23,4	31,8	3,5	PU-3/4"	3,85
1"	420	31,3	39,7	3,5	PU-1"	4,75
1 1/4"	420	36,1	44,5	3,5	PU-1 1/4"	5,25
1 1/2"	420	45,4	53,8	3,5	PU-1 1/2"	8,83
2"	420	55,0	63,4	3,5	PU-2"	9,12

ZWEIKANTEN-SCHNEIDRINGE

DOUBLE-BITE CUTTING RINGS



EDELSTAHL / STAINLESS STEEL
VERBINDUNGSTECHNIK
FLUID CONNECTORS

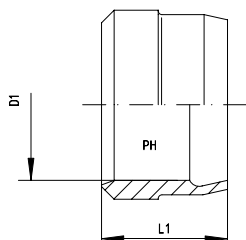

Gehärtet (carbonitriert)

Die Typen LL sind Einkanten-Schneidringe.

Auf Anfrage: Schneidringe mit zusätzlicher Weichdichtung

Hardened (carbonized)

The Types LL are One-Bite Cutting Rings.

On Request: Cutting Rings with Soft Seal

Rohr A.D. Tube O.D. D1	L1	DN 3861	Bestellzeichen Order-Code	Brutto-Preis Gross-Price Euro (€)
4	6,0	ALL 4	SR-LL-04/1 K	0,51
6	7,0	ALL 6	SR-LL-06/1 K	0,64
8	7,0	ALL 8	SR-LL-08/1 K	0,79

Rohr A.D. Tube O.D. D1	L1	DN 3861	Bestellzeichen Order-Code	Brutto-Preis Gross-Price Euro (€)
6	9,0	BL 6	SR-L-06/2 K	0,59
8	9,0	BL 8	SR-L-08/2 K	0,69
10	9,5	BL 10	SR-L-10/2 K	0,97
12	10,0	BL 12	SR-L-12/2 K	1,10
15	10,0	BL 15	SR-L-15/2 K	1,35
18	10,0	BL 18	SR-L-18/2 K	1,51
22	11,0	BL 22	SR-L-22/2 K	1,69
28	11,0	BL 28	SR-L-28/2 K	2,58
35	13,5	BL 35	SR-L-35/2 K	3,78
42	13,5	BL 42	SR-L-42/2 K	4,32

Rohr A.D. Tube O.D. D1	L1	DN 3861	Bestellzeichen Order-Code	Brutto-Preis Gross-Price Euro (€)
6	9,0	BS 6	SR-S-06/2 K	0,59
8	9,0	BS 8	SR-S-08/2 K	0,69
10	9,5	BS 10	SR-S-10/2 K	0,97
12	10,0	BS 12	SR-S-12/2 K	1,10
14	9,5	BS 14	SR-S-14/2 K	1,33
16	10,0	BS 16	SR-S-16/2 K	1,38
20	11,5	BS 20	SR-S-20/2 K	1,61
25	12,5	BS 25	SR-S-25/2 K	2,51
30	12,5	BS 30	SR-S-30/2 K	3,63
38	13,5	BS 38	SR-S-38/2 K	3,89

Vom normalen Rabatt ausgeschlossen!
Excluding the ordinary discount!

ES4-ZWEIKANTEN-SCHNEIDRINGE MIT WEICHDICHTUNG - VITON

ES4-DOUBLE-BITE CUTTING RINGS
WITH SOFT-SEAL - VITON



Gehärtet

Hardened

Rohr A.D. Tube O.D. D1	L1	Druck Pressure PN	Bestellzeichen Order-Code	Brutto-Preis Gross-Price Euro (€)
6	8,8	315	ES4-L-06-wd	4,60
8	8,8	315	ES4-L-08-wd	4,94
10	9,8	315	ES4-L-10-wd	6,30
12	9,8	315	ES4-L-12-wd	6,29
15	10,2	315	ES4-L-15-wd	7,58
18	10,2	315	ES4-L-18-wd	6,90
22	11,5	160	ES4-L-22-wd	9,14
28	11,5	160	ES4-L-28-wd	11,56
35	13,5	160	ES4-L-35-wd	17,07
42	13,5	160	ES4-L-42-wd	24,81

Rohr A.D. Tube O.D. D1	L1	Druck Pressure PN	Bestellzeichen Order-Code	Brutto-Preis Gross-Price Euro (€)
6	8,8	630	ES4-S-06-wd	4,60
8	8,8	630	ES4-S-08-wd	4,94
10	9,8	630	ES4-S-10-wd	6,30
12	9,8	630	ES4-S-12-wd	6,29
14	10,2	630	ES4-S-14-wd	9,73
16	10,2	400	ES4-S-16-wd	8,03
20	12,5	400	ES4-S-20-wd	8,36
25	12,5	400	ES4-S-25-wd	10,93
30	13,5	400	ES4-S-30-wd	15,06
38	13,5	315	ES4-S-38-wd	24,55

Vom normalen Rabatt ausgeschlossen!
Excluding the ordinary discount!

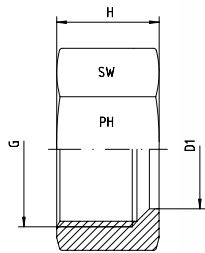

DIN 3870 + DIN EN ISO 8434-1
Für Schneidringanschluss

DIN 3870 + DIN EN ISO 8434-1
For Cutting Ring Connection

Rohr A.D. Tube O.D. D1	Gewinde Thread G	Ca. Maße Approx. Dimensions		DIN 3861	Bestellzeichen Order-Code Standard	Brutto-Preis Gross-Price Euro (€)
		SW	H			
4	M 8 x 1	10	11,0	ALL 4	ÜWM-LL-04	2,15
6	M 10 x 1	12	12,0	ALL 6	ÜWM-LL-06	2,40
8	M 12 x 1	14	12,5	ALL 8	ÜWM-LL-08	2,71

Rohr A.D. Tube O.D. D1	Gewinde Thread G	Ca. Maße Approx. Dimensions		ISO 8434-1	Bestellzeichen Order-Code Standard	Brutto-Preis Gross-Price Euro (€)
		SW	H			
6	M 12 x 1,5	14	14,5	N-L 6	ÜWM-L-06	1,72
8	M 14 x 1,5	17	14,5	N-L 8	ÜWM-L-08	2,11
10	M 16 x 1,5	19	15,5	N-L 10	ÜWM-L-10	2,39
12	M 18 x 1,5	22	15,5	N-L 12	ÜWM-L-12	2,79
15	M 22 x 1,5	27	17,0	N-L 15	ÜWM-L-15	3,79
18	M 26 x 1,5	32	18,0	N-L 18	ÜWM-L-18	7,11
22	M 30 x 2	36	20,0	N-L 22	ÜWM-L-22	8,62
28	M 36 x 2	41	21,0	N-L 28	ÜWM-L-28	12,27
35	M 45 x 2	50	24,0	N-L 35	ÜWM-L-35	17,33
42	M 52 x 2	60	24,0	N-L 42	ÜWM-L-42	23,11

Rohr A.D. Tube O.D. D1	Gewinde Thread G	Ca. Maße Approx. Dimensions		ISO 8434-1	Bestellzeichen Order-Code Standard	Brutto-Preis Gross-Price Euro (€)
		SW	H			
6	M 14 x 1,5	17	16,5	N-S 6	ÜWM-S-06	2,20
8	M 16 x 1,5	19	16,5	N-S 8	ÜWM-S-08	2,51
10	M 18 x 1,5	22	17,5	N-S 10	ÜWM-S-10	2,97
12	M 20 x 1,5	24	17,5	N-S 12	ÜWM-S-12	3,35
14	M 22 x 1,5	27	20,5	N-S 14	ÜWM-S-14	4,17
16	M 24 x 1,5	30	20,5	N-S 16	ÜWM-S-16	6,83
20	M 30 x 2	36	24,0	N-S 20	ÜWM-S-20	8,97
25	M 36 x 2	46	27,0	N-S 25	ÜWM-S-25	16,11
30	M 42 x 2	50	29,0	N-S 30	ÜWM-S-30	19,81
38	M 52 x 2	60	32,5	N-S 38	ÜWM-S-38	27,92

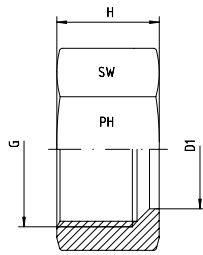

DIN 3870 + DIN EN ISO 8434-1
Für Schneidringanschluss

DIN 3870 + DIN EN ISO 8434-1
For Cutting Ring Connection

Rohr A.D. Tube O.D. D1	Gewinde Thread G	Ca. Maße Approx. Dimensions		DN 3861	ISO 8434-1	Bestellzeichen Order-Code SC	Brutto-Preis Gross-Price Euro (€)
		SW	H				
6	M 12 x 1,5	14	14,5		N-L 6	ÜWM-L-06-SC	2,14
8	M 14 x 1,5	17	14,5		N-L 8	ÜWM-L-08-SC	2,68
10	M 16 x 1,5	19	15,5		N-L 10	ÜWM-L-10-SC	2,97
12	M 18 x 1,5	22	15,5		N-L 12	ÜWM-L-12-SC	3,52
15	M 22 x 1,5	27	17,0		N-L 15	ÜWM-L-15-SC	5,11
18	M 26 x 1,5	32	18,0		N-L 18	ÜWM-L-18-SC	9,19
22	M 30 x 2	36	20,0		N-L 22	ÜWM-L-22-SC	10,90
28	M 36 x 2	41	21,0		N-L 28	ÜWM-L-28-SC	14,98
35	M 45 x 2	50	24,0		N-L 35	ÜWM-L-35-SC	22,10
42	M 52 x 2	60	24,0		N-L 42	ÜWM-L-42-SC	28,80

Rohr A.D. Tube O.D. D1	Gewinde Thread G	Ca. Maße Approx. Dimensions		DN 3861	ISO 8434-1	Bestellzeichen Order-Code SC	Brutto-Preis Gross-Price Euro (€)
		SW	H				
6	M 14 x 1,5	17	16,5		N-S 6	ÜWM-S-06-SC	2,77
8	M 16 x 1,5	19	16,5		N-S 8	ÜWM-S-08-SC	3,10
10	M 18 x 1,5	22	17,5		N-S 10	ÜWM-S-10-SC	3,71
12	M 20 x 1,5	24	17,5		N-S 12	ÜWM-S-12-SC	4,40
14	M 22 x 1,5	27	20,5		N-S 14	ÜWM-S-14-SC	6,02
16	M 24 x 1,5	30	20,5		N-S 16	ÜWM-S-16-SC	8,81
20	M 30 x 2	36	24,0		N-S 20	ÜWM-S-20-SC	11,39
25	M 36 x 2	46	27,0		N-S 25	ÜWM-S-25-SC	20,07
30	M 42 x 2	50	29,0		N-S 30	ÜWM-S-30-SC	25,17
38	M 52 x 2	60	32,5		N-S 38	ÜWM-S-38-SC	35,24





EDELSTAHL / STAINLESS STEEL
VERBINDUNGSTECHNIK
FLUID CONNECTORS







Dichtkegel-Verschraubungen mit 24°-Kegel und O-Ring – Viton

Cone Sealing Couplings with 24°-Cone and O-ring – Viton





DICHTKEGEL-Verschraubungen mit 24°-Kegel und O-Ring - VITON - DIN EN ISO 8434-1

CONE SEALING COUPLINGS WITH 24°-CONE AND O-RING - VITON - DIN EN ISO 8434-1

Produktgruppen	Product Groups	Seite Page
Montageanleitung	Assembly Instruction	9.3
 <p>Gerade Verschraubungen - L- und S-Reihe - GV - DKO - DKO</p>	Swivel Unions - L- and S-Series - GV - DKO - DKO	9.4
 <p>Gerade Reduzierungen - GVR - DKO - DKO - L / L- und S / S-Reihe - GVR - DKO - DKO - L / S- and S / L-Series</p>	Straight Reducers - GVR - DKO - DKO - L / L- and S / S-Series - GVR - DKO - DKO - L / S- and S / L-Series	9.5 9.6
 <p>EW-Verschraubungen - L- und S-Reihe - Standard - SC - OMD - Metrisch - Zylindrisch - Standard - Metrisch - Zylindrisch - SC - Metrisch - Zylindrisch - OMD - Whitworth - Zylindrisch - Standard - Whitworth - Zylindrisch - SC - Whitworth - Zylindrisch - OMD</p>	Adjustable Stud Elbows - L- and S-Series - Standard - SC - OMD - Metric - Parallel - Standard - Metric - Parallel - SC - Metric - Parallel - OMD - BSP - Parallel - Standard - BSP - Parallel - SC - BSP - Parallel - OMD	9.7 9.8 9.9 9.10 9.11 9.12 9.13 9.14 9.15
 <p>EV-Verschraubungen - 45° - L- und S-Reihe - Standard - SC - OMD</p>	Adjustable Stud Elbows - 45° - L- and S-Series - Standard - SC - OMD	9.16 9.17 9.18
 <p>ET-Verschraubungen - L- und S-Reihe - Standard - SC - OMD - Metrisch - Zylindrisch - Standard - Metrisch - Zylindrisch - SC - Metrisch - Zylindrisch - OMD - Whitworth - Zylindrisch - Standard - Whitworth - Zylindrisch - SC - Whitworth - Zylindrisch - OMD</p>	Adjustable Stud Branch Tees - L- and S-Series - Standard - SC - OMD - Metric - Parallel - Standard - Metric - Parallel - SC - Metric - Parallel - OMD - BSP - Parallel - Standard - BSP - Parallel - SC - BSP - Parallel - OMD	9.19 9.20 9.21 9.22 9.23 9.24 9.25 9.26 9.27
 <p>EL-Verschraubungen - L- und S-Reihe - Standard - SC - OMD - Metrisch - Zylindrisch - Standard - Metrisch - Zylindrisch - SC - Metrisch - Zylindrisch - OMD - Whitworth - Zylindrisch - Standard - Whitworth - Zylindrisch - SC - Whitworth - Zylindrisch - OMD</p>	Adjustable Stud Barrel Tees - L- and S-Series - Standard - SC - OMD - Metric - Parallel - Standard - Metric - Parallel - SC - Metric - Parallel - OMD - BSP - Parallel - Standard - BSP - Parallel - SC - BSP - Parallel - OMD	9.28 9.29 9.30 9.31 9.32 9.33 9.34 9.35 9.36
 <p>Reduzier-Verschraubungen - L- und S-Reihe - RED-DKOL - Standard - RED-DKOL - SC - RED-DKOL - OMD - RED-DKOS - Standard - RED-DKOS - SC - RED-DKOS - OMD</p>	Reducing Couplings - L- and S-Series - RED-DKOL - Standard - RED-DKOL - SC - RED-DKOL - OMD - RED-DKOS - Standard - RED-DKOS - SC - RED-DKOS - OMD	9.37 9.38 9.39 9.40 9.41 9.42

Standard = Überwurfmutter blank / Tube nuts are supplied unplated
SC = Überwurfmutter bis Größe 12-S ist mit gleitbeschichtet / Tube nuts until size 12-L are supplied chemical plated
= Überwurfmutter ab Größe 12-S ist mit versilbertem Gewinde / Tube nuts from size 12-S are supplied with silver plated thread
OMD = Verschraubung ohne Überwurfmutter und Schneidring am Außengewinde / Couplings are supplied without nut and cutting ring at male thread



Produktgruppen	Product Groups	Seite Page
 Gerade Einschraubstutzen - EGE - L- und S-Reihe - Metrisch - Zylindrisch - Whitworth - Zylindrisch - NPT	EGE - Swivel Connectors - L- and S-Series - Metric - Parallel - BSP - Parallel - NPT	9.43 9.44 9.45
 Manometer-Verschraubungen - L- und S-Reihe	Gauge Swivel Connectors - L- and S-Series	9.46
 Distanzadapter - DA - L- und S-Reihe - DA - DKO - Standard - DA - DKO - SC - DA - DKO - OMD	Distance Piece Adaptors - DA - L- and S-Series - DA - DKO - Standard - DA - DKO - SC - DA - DKO - OMD	9.47 9.48 9.49

Standard = Überwurfmutter blank / Tube nuts are supplied unplated

SC = Überwurfmutter bis Größe 12-S ist ist gleitbeschichtet / Tube nuts until size 12-L are supplied chemical plated

= Überwurfmutter ab Größe 12-S ist mit versilbertem Gewinde / Tube nuts from size 12-S are supplied with silver plated thread

OMD = Verschraubung ohne Überwurfmutter und Schneidring am Außengewinde / Couplings are supplied without nut and cutting ring at male thread

Mit 24°-Kegel und O-Ring - Viton - DIN EN ISO 8434-1

With 24°-Cone and O-ring - Viton - DIN EN ISO 8434-1

1. PH-Dichtkegel-Verschraubungen müssen im dazugehörigen Verschraubungskörper endmontiert werden.
2. Bei Edelstahl-Verschraubungen müssen die Gewinde geschmiert werden (wie z.B. Gleitmo 810 oder High Tech Paste ASW 040 P; siehe Kapitel 12).
Es handelt sich hierbei um spezielle Schmierstoffe für Edelstahl-Verschraubungen.

1. *PH cone sealing couplings must be pre-assembled in the associated body.*
2. *Stainless steel fittings must be lubricated at the thread (for example use Gleitmo 810 or High Tech Paste ASW 040 P; see chapter 12). These are special lubricants for stainless steel fittings.*



3. Überwurfmutter von Hand bis zum fühlbaren Anschlag aufschrauben.

3. *Screw the nut by hand onto the body until stop is felt.*

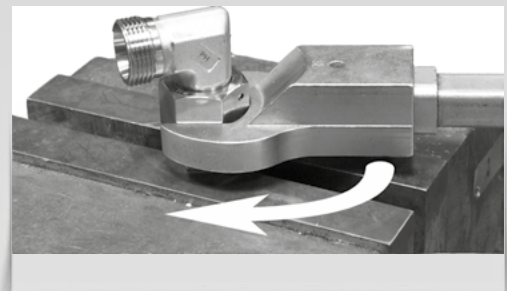
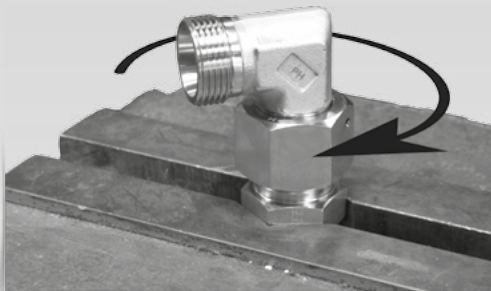

4. Danach mit einer 1/4 Umdrehung festziehen (1 1/2 Schlüsselflächen).

4. *Then tighten it with a 1/4 turn (1 1/2 spanner flat).*

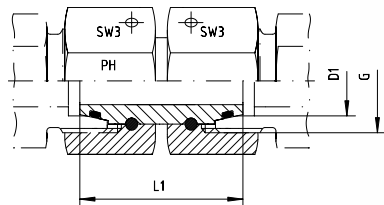

Mit Dichtkegel und O-Ring - Viton
Passend in Bohrungsform W DIN 3861

With Taper and O-ring - Viton
For Type of Port End W DIN 3861

Reihe Series	Druck Pressure PN	Rohr A.D. Tube O.D. D1	Gewinde Thread G	Ca. Maße Approx. Dimensions		Bestellzeichen Order-Code	Brutto-Preis Gross-Price Euro (€)
				L1	SW3		
L	500	6	M 12 x 1,5	33,0	14	GV-DKOL-06	18,87
L	500	8	M 14 x 1,5	33,7	17	GV-DKOL-08	20,17
L	500	10	M 16 x 1,5	34,5	19	GV-DKOL-10	22,80
L	400	12	M 18 x 1,5	35,0	22	GV-DKOL-12	24,93
L	400	15	M 22 x 1,5	39,0	27	GV-DKOL-15	35,23
L	400	18	M 26 x 1,5	38,0	32	GV-DKOL-18	49,14
L	250	22	M 30 x 2	43,0	36	GV-DKOL-22	58,26
L	250	28	M 36 x 2	46,0	41	GV-DKOL-28	86,92
L	250	35	M 45 x 2	47,0	50	GV-DKOL-35	120,16
L	250	42	M 52 x 2	52,0	60	GV-DKOL-42	142,14

Reihe Series	Druck Pressure PN	Rohr A.D. Tube O.D. D1	Gewinde Thread G	Ca. Maße Approx. Dimensions		Bestellzeichen Order-Code	Brutto-Preis Gross-Price Euro (€)
				L1	SW3		
S	800	6	M 14 x 1,5	33,0	17	GV-DKOS-06	20,91
S	800	8	M 16 x 1,5	36,0	19	GV-DKOS-08	22,73
S	800	10	M 18 x 1,5	36,0	22	GV-DKOS-10	24,95
S	630	12	M 20 x 1,5	38,0	24	GV-DKOS-12	28,07
S	630	14	M 22 x 1,5	38,0	27	GV-DKOS-14	38,17
S	630	16	M 24 x 1,5	39,0	30	GV-DKOS-16	47,53
S	420	20	M 30 x 2	46,5	36	GV-DKOS-20	58,80
S	420	25	M 36 x 2	47,5	46	GV-DKOS-25	99,70
S	420	30	M 42 x 2	52,0	50	GV-DKOS-30	125,27
S	420	38	M 52 x 2	52,5	60	GV-DKOS-38	171,29

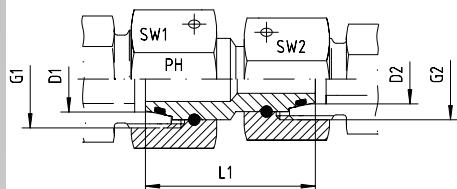

Beide Seiten mit drehbarer Mutter - DKO
Mit Dichtkegel und O-Ring - Viton
Passend in Bohrungsform W DIN 3861

Both sides with Swivel Nut - DKO
With Taper and O-ring - Viton
For Type of Port End W DIN 3861

Reihe Series	Druck Pressure PN	Rohr A.D. Tube O.D.		Gewinde Thread		Ca. Maße Approx. Dimensions			Bestellzeichen Order-Code	Brutto-Preis Gross-Price Euro (€)
		D1	D2	G1	G2	L1	SW1	SW2		
L	500	8	6	M 14 x 1,5	M 12 x 1,5	31,0	17	14	GVR-DKO-08-L/06-L	19,43
L	500	10	6	M 16 x 1,5	M 12 x 1,5	34,0	19	14	GVR-DKO-10-L/06-L	21,90
L	500	10	8	M 16 x 1,5	M 14 x 1,5	33,0	19	17	GVR-DKO-10-L/08-L	21,99
L	400	12	6	M 18 x 1,5	M 12 x 1,5	34,0	22	14	GVR-DKO-12-L/06-L	24,30
L	400	12	8	M 18 x 1,5	M 14 x 1,5	34,0	22	17	GVR-DKO-12-L/08-L	24,30
L	400	12	10	M 18 x 1,5	M 16 x 1,5	33,0	22	19	GVR-DKO-12-L/10-L	24,54
L	400	15	8	M 22 x 1,5	M 14 x 1,5	37,0	27	17	GVR-DKO-15-L/08-L	34,26
L	400	15	10	M 22 x 1,5	M 16 x 1,5	38,0	27	19	GVR-DKO-15-L/10-L	34,51
L	400	15	12	M 22 x 1,5	M 18 x 1,5	35,0	27	22	GVR-DKO-15-L/12-L	34,77
L	400	18	10	M 26 x 1,5	M 16 x 1,5	36,3	32	19	GVR-DKO-18-L/10-L	48,15
L	400	18	12	M 26 x 1,5	M 18 x 1,5	38,0	32	22	GVR-DKO-18-L/12-L	48,16
L	400	18	15	M 26 x 1,5	M 22 x 1,5	43,0	32	27	GVR-DKO-18-L/15-L	48,63
L	250	22	12	M 30 x 2	M 18 x 1,5	42,0	36	22	GVR-DKO-22-L/12-L	56,90
L	250	22	15	M 30 x 2	M 22 x 1,5	43,5	36	27	GVR-DKO-22-L/15-L	57,01
L	250	22	18	M 30 x 2	M 26 x 1,5	43,0	36	32	GVR-DKO-22-L/18-L	57,75
L	250	28	15	M 36 x 2	M 22 x 1,5		41	27	GVR-DKO-28-L/15-L	85,70
L	250	28	18	M 36 x 2	M 26 x 1,5	46,0	41	32	GVR-DKO-28-L/18-L	85,80
L	250	28	22	M 36 x 2	M 30 x 2		41	36	GVR-DKO-28-L/22-L	86,15
L	250	35	18	M 45 x 2	M 26 x 1,5	44,0	50	32	GVR-DKO-35-L/18-L	119,00
L	250	35	22	M 45 x 2	M 30 x 2		50	36	GVR-DKO-35-L/22-L	119,50
L	250	35	28	M 45 x 2	M 36 x 2	46,5	50	41	GVR-DKO-35-L/28-L	120,13
L	250	42	22	M 52 x 2	M 30 x 2	47,0	60	36	GVR-DKO-42-L/22-L	150,00
L	250	42	28	M 52 x 2	M 36 x 2	47,5	60	41	GVR-DKO-42-L/28-L	150,00
L	250	42	35	M 52 x 2	M 45 x 2	52,0	60	50	GVR-DKO-42-L/35-L	150,83

Reihe Series	Druck Pressure PN	Rohr A.D. Tube O.D.		Gewinde Thread		Ca. Maße Approx. Dimensions			Bestellzeichen Order-Code	Brutto-Preis Gross-Price Euro (€)
		D1	D2	G1	G2	L1	SW1	SW2		
S	800	8	6	M 16 x 1,5	M 14 x 1,5	35,5	19	17	GVR-DKO-08-S/06-S	22,24
S	800	10	6	M 18 x 1,5	M 14 x 1,5	35,5	22	17	GVR-DKO-10-S/06-S	27,00
S	800	10	8	M 18 x 1,5	M 16 x 1,5	37,0	22	19	GVR-DKO-10-S/08-S	24,44
S	630	12	6	M 20 x 1,5	M 14 x 1,5	36,0	24	17	GVR-DKO-12-S/06-S	27,50
S	630	12	8	M 20 x 1,5	M 16 x 1,5	37,5	24	19	GVR-DKO-12-S/08-S	27,50
S	630	12	10	M 20 x 1,5	M 18 x 1,5	37,5	24	22	GVR-DKO-12-S/10-S	27,56
S	630	16	10	M 24 x 1,5	M 18 x 1,5	37,5	30	22	GVR-DKO-16-S/10-S	46,40
S	630	16	12	M 24 x 1,5	M 20 x 1,5	38,0	30	24	GVR-DKO-16-S/12-S	46,78
S	630	16	14	M 24 x 1,5	M 22 x 1,5	47,0	30	27	GVR-DKO-16-S/14-S	47,95
S	420	20	12	M 30 x 2	M 20 x 1,5	43,0	36	24	GVR-DKO-20-S/12-S	58,90
S	420	20	14	M 30 x 2	M 22 x 1,5		36	27	GVR-DKO-20-S/14-S	78,20
S	420	20	16	M 30 x 2	M 24 x 1,5	43,0	36	30	GVR-DKO-20-S/16-S	59,37
S	420	25	16	M 36 x 2	M 24 x 1,5	46,0	46	30	GVR-DKO-25-S/16-S	99,10
S	420	25	20	M 36 x 2	M 30 x 2	46,0	46	36	GVR-DKO-25-S/20-S	99,70
S	420	30	16	M 42 x 2	M 24 x 1,5	46,0	50	30	GVR-DKO-30-S/16-S	123,70
S	420	30	20	M 42 x 2	M 30 x 2	52,0	50	36	GVR-DKO-30-S/20-S	123,70
S	420	30	25	M 42 x 2	M 36 x 2	52,0	50	46	GVR-DKO-30-S/25-S	124,32
S	420	38	20	M 52 x 2	M 30 x 2	52,0	60	36	GVR-DKO-38-S/20-S	172,00
S	420	38	25	M 52 x 2	M 36 x 2	53,0	60	46	GVR-DKO-38-S/25-S	172,50
S	420	38	30	M 52 x 2	M 42 x 2	52,0	60	50	GVR-DKO-38-S/30-S	173,00

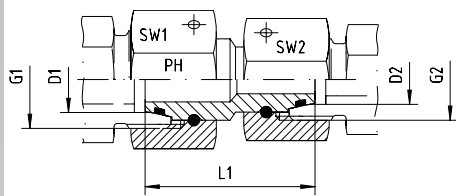

Beide Seiten mit drehbarer Mutter - DKO
Mit Dichtkegel und O-Ring - Viton
Passend in Bohrungsform W DIN 3861

Both sides with Swivel Nut - DKO
With Taper and O-ring - Viton
For Type of Port End W DIN 3861

Reihe Series	Druck Pressure PN	Rohr A.D. Tube O.D.		Gewinde Thread		Ca. Maße Approx. Dimensions			Bestellzeichen Order-Code	Brutto-Preis Gross-Price Euro (€)
		D1	D2	G1	G2	L1	SW1	SW2		
L/S	500	6	6	M 14 x 1,5	M 12 x 1,5	33,0	17	14	GVR-DKO-06-L/06-S	38,86
L/S	500	8	6	M 14 x 1,5	M 14 x 1,5		17	17	GVR-DKO-08-L/06-S	43,95
L/S	500	8	8	M 16 x 1,5	M 14 x 1,5	35,0	19	17	GVR-DKO-08-L/08-S	43,97
L/S	500	10	10	M 18 x 1,5	M 16 x 1,5	35,3	22	19	GVR-DKO-10-L/10-S	49,08
L/S	400	12	10	M 18 x 1,5	M 18 x 1,5	32,5	22	22	GVR-DKO-12-L/10-S	61,35
L/S	400	12	12	M 20 x 1,5	M 18 x 1,5	37,0	24	22	GVR-DKO-12-L/12-S	61,36
L/S	400	15	12	M 22 x 1,5	M 20 x 1,5	38,5	27	24	GVR-DKO-15-L/12-S	75,10
L/S	400	15	14	M 22 x 1,5	M 22 x 1,5	44,5	27	27	GVR-DKO-15-L/14-S	77,90
L/S	400	18	16	M 26 x 1,5	M 24 x 1,5	40,0	32	30	GVR-DKO-18-L/16-S	84,36
L/S	250	22	20	M 30 x 2	M 30 x 2	53,0	36	36	GVR-DKO-22-L/20-S	93,31
L/S	250	28	25	M 36 x 2	M 36 x 2	46,0	46	41	GVR-DKO-28-L/25-S	122,84
L/S	250	35	30	M 45 x 2	M 42 x 2	51,0	50	50	GVR-DKO-35-L/30-S	148,53
L/S	250	42	38	M 52 x 2	M 52 x 2	52,0	60	60	GVR-DKO-42-L/38-S	194,29

Reihe Series	Druck Pressure PN	Rohr A.D. Tube O.D.		Gewinde Thread		Ca. Maße Approx. Dimensions			Bestellzeichen Order-Code	Brutto-Preis Gross-Price Euro (€)
		D1	D2	G1	G2	L1	SW1	SW2		
S/L	500	10	8	M 18 x 1,5	M 14 x 1,5	33,0	22	17	GVR-DKO-10-S/08-L	49,00
S/L	500	12	8	M 20 x 1,5	M 14 x 1,5	34,0	24	17	GVR-DKO-12-S/08-L	61,35
S/L	500	12	10	M 20 x 1,5	M 16 x 1,5	33,0	24	19	GVR-DKO-12-S/10-L	61,35
S/L	500	16	10	M 24 x 1,5	M 16 x 1,5	35,5	30	19	GVR-DKO-16-S/10-L	82,40
S/L	400	16	12	M 24 x 1,5	M 18 x 1,5	39,0	30	22	GVR-DKO-16-S/12-L	82,40
S/L	400	16	15	M 24 x 1,5	M 22 x 1,5	38,5	30	27	GVR-DKO-16-S/15-L	82,50
S/L	400	20	18	M 30 x 2	M 26 x 1,5	43,0	36	32	GVR-DKO-20-S/18-L	86,40
S/L	400	25	18	M 36 x 2	M 26 x 1,5	44,0	46	32	GVR-DKO-25-S/18-L	139,00
S/L	250	25	22	M 36 x 2	M 30 x 2	46,0	46	36	GVR-DKO-25-S/22-L	99,70
S/L	250	30	28	M 42 x 2	M 36 x 2	49,5	50	41	GVR-DKO-30-S/28-L	144,80
S/L	250	38	35	M 52 x 2	M 45 x 2	53,0	60	50	GVR-DKO-38-S/35-L	191,80

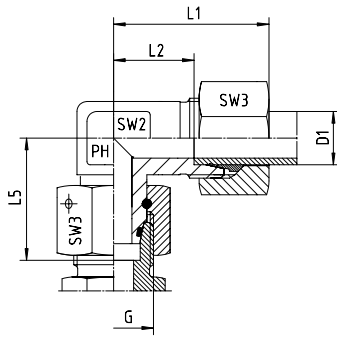

Einstellbare Winkelverschraubungen mit Dichtkegel und O-Ring Viton
Rohrseitig Schneidringanschluss

*With Taper and O-ring - Viton
Cutting Ring Connection at the Tube Connection side*

Reihe Series	Druck Pressure PN	Rohr A.D. Tube O.D. D1	Gewinde Thread G	Ca. Maße Approx. Dimensions					Bestellzeichen Order-Code Standard	Brutto-Preis Gross-Price Euro (€)
				L1	L2	L5	SW2	SW3		
L	500	6	M 12 x 1,5	27	12,0	26,0	12	14	EW-DKOL-06	23,78
L	500	8	M 14 x 1,5	29	14,0	27,5	12	17	EW-DKOL-08	24,21
L	500	10	M 16 x 1,5	30	15,0	29,0	14	19	EW-DKOL-10	31,47
L	400	12	M 18 x 1,5	32	17,0	29,5	17	22	EW-DKOL-12	34,46
L	400	15	M 22 x 1,5	36	21,0	32,5	19	27	EW-DKOL-15	40,29
L	400	18	M 26 x 1,5	40	23,5	35,5	24	32	EW-DKOL-18	61,36
L	250	22	M 30 x 2	44	27,5	38,5	27	36	EW-DKOL-22	76,69
L	250	28	M 36 x 2	47	30,5	41,5	36	41	EW-DKOL-28	120,16
L	250	35	M 45 x 2	56	34,5	51,0	41	50	EW-DKOL-35	168,73
L	250	42	M 52 x 2	63	40,0	56,0	50	60	EW-DKOL-42	250,54

Reihe Series	Druck Pressure PN	Rohr A.D. Tube O.D. D1	Gewinde Thread G	Ca. Maße Approx. Dimensions					Bestellzeichen Order-Code Standard	Brutto-Preis Gross-Price Euro (€)
				L1	L2	L5	SW2	SW3		
S	800	6	M 14 x 1,5	31	16,0	27,0	12	17	EW-DKOS-06	26,15
S	800	8	M 16 x 1,5	32	17,0	27,5	14	19	EW-DKOS-08	29,32
S	800	10	M 18 x 1,5	34	17,5	30,0	17	22	EW-DKOS-10	35,38
S	630	12	M 20 x 1,5	38	21,5	31,0	17	24	EW-DKOS-12	40,88
S	630	14	M 22 x 1,5	40	22,0	35,0	19	27	EW-DKOS-14	49,11
S	630	16	M 24 x 1,5	43	24,5	36,5	24	30	EW-DKOS-16	63,91
S	420	20	M 30 x 2	48	26,5	44,5	27	36	EW-DKOS-20	81,81
S	420	25	M 36 x 2	54	30,0	50,0	36	46	EW-DKOS-25	132,94
S	420	30	M 42 x 2	62	35,5	55,0	41	50	EW-DKOS-30	181,51
S	420	38	M 52 x 2	72	41,0	63,0	50	60	EW-DKOS-38	263,32

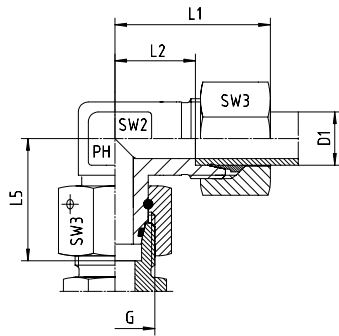

Einstellbare Winkelverschraubungen mit Dichtkegel und O-Ring Viton
Rohrseitig Schneidringanschluss

*With Taper and O-ring - Viton
Cutting Ring Connection at the Tube Connection side*

Reihe Series	Druck Pressure PN	Rohr A.D. Tube O.D. D1	Gewinde Thread G	Ca. Maße Approx. Dimensions					Bestellzeichen Order-Code SC	Brutto-Preis Gross-Price Euro (€)
				L1	L2	L5	SW2	SW3		
L	500	6	M 12 x 1,5	27	12,0	26,0	12	14	EW-DKOL-06-SC	24,10
L	500	8	M 14 x 1,5	29	14,0	27,5	12	17	EW-DKOL-08-SC	24,65
L	500	10	M 16 x 1,5	30	15,0	29,0	14	19	EW-DKOL-10-SC	31,91
L	400	12	M 18 x 1,5	32	17,0	29,5	17	22	EW-DKOL-12-SC	35,02
L	400	15	M 22 x 1,5	36	21,0	32,5	19	27	EW-DKOL-15-SC	41,37
L	400	18	M 26 x 1,5	40	23,5	35,5	24	32	EW-DKOL-18-SC	63,00
L	250	22	M 30 x 2	44	27,5	38,5	27	36	EW-DKOL-22-SC	78,45
L	250	28	M 36 x 2	47	30,5	41,5	36	41	EW-DKOL-28-SC	122,16
L	250	35	M 45 x 2	56	34,5	51,0	41	50	EW-DKOL-35-SC	172,45
L	250	42	M 52 x 2	63	40,0	56,0	50	60	EW-DKOL-42-SC	254,86

Reihe Series	Druck Pressure PN	Rohr A.D. Tube O.D. D1	Gewinde Thread G	Ca. Maße Approx. Dimensions					Bestellzeichen Order-Code SC	Brutto-Preis Gross-Price Euro (€)
				L1	L2	L5	SW2	SW3		
S	800	6	M 14 x 1,5	31	16,0	27,0	12	17	EW-DKOS-06-SC	26,59
S	800	8	M 16 x 1,5	32	17,0	27,5	14	19	EW-DKOS-08-SC	29,76
S	800	10	M 18 x 1,5	34	17,5	30,0	17	22	EW-DKOS-10-SC	35,94
S	630	12	M 20 x 1,5	38	21,5	31,0	17	24	EW-DKOS-12-SC	41,72
S	630	14	M 22 x 1,5	40	22,0	35,0	19	27	EW-DKOS-14-SC	50,67
S	630	16	M 24 x 1,5	43	24,5	36,5	24	30	EW-DKOS-16-SC	65,47
S	420	20	M 30 x 2	48	26,5	44,5	27	36	EW-DKOS-20-SC	83,69
S	420	25	M 36 x 2	54	30,0	50,0	36	46	EW-DKOS-25-SC	135,94
S	420	30	M 42 x 2	62	35,5	55,0	41	50	EW-DKOS-30-SC	185,67
S	420	38	M 52 x 2	72	41,0	63,0	50	60	EW-DKOS-38-SC	268,96



Einstellbare Winkelverschraubungen mit Dichtkegel
und O-Ring Viton
Rohrseitig Schneidringanschluss

*With Taper and O-ring - Viton
Cutting Ring Connection at the Tube Connection side*

Reihe Series	Druck Pressure PN	Rohr A.D. Tube O.D. D1	Gewinde Thread G	Ca. Maße Approx. Dimensions				Bestellzeichen Order-Code OMD	Brutto-Preis Gross-Price Euro (€)
L	500	6	M 12 x 1,5					EW-DKOL-06-OMD	21,47
L	500	8	M 14 x 1,5					EW-DKOL-08-OMD	21,41
L	500	10	M 16 x 1,5					EW-DKOL-10-OMD	28,11
L	400	12	M 18 x 1,5					EW-DKOL-12-OMD	30,57
L	400	15	M 22 x 1,5					EW-DKOL-15-OMD	35,15
L	400	18	M 26 x 1,5					EW-DKOL-18-OMD	52,74
L	250	22	M 30 x 2					EW-DKOL-22-OMD	66,38
L	250	28	M 36 x 2					EW-DKOL-28-OMD	105,31
L	250	35	M 45 x 2					EW-DKOL-35-OMD	147,62
L	250	42	M 52 x 2					EW-DKOL-42-OMD	223,11

Reihe Series	Druck Pressure PN	Rohr A.D. Tube O.D. D1	Gewinde Thread G	Ca. Maße Approx. Dimensions				Bestellzeichen Order-Code OMD	Brutto-Preis Gross-Price Euro (€)
S	800	6	M 14 x 1,5					EW-DKOS-06-OMD	23,36
S	800	8	M 16 x 1,5					EW-DKOS-08-OMD	26,12
S	800	10	M 18 x 1,5					EW-DKOS-10-OMD	31,44
S	630	12	M 20 x 1,5					EW-DKOS-12-OMD	36,43
S	630	14	M 22 x 1,5					EW-DKOS-14-OMD	43,61
S	630	16	M 24 x 1,5					EW-DKOS-16-OMD	55,70
S	420	20	M 30 x 2					EW-DKOS-20-OMD	71,23
S	420	25	M 36 x 2					EW-DKOS-25-OMD	114,32
S	420	30	M 42 x 2					EW-DKOS-30-OMD	158,07
S	420	38	M 52 x 2					EW-DKOS-38-OMD	231,51

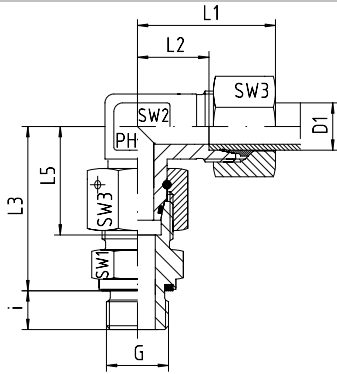

Einstellbare Winkelverschraubungen mit Dichtkegel und O-Ring Viton
Rohrseitig Schneidringanschluss
Einschraubgewinde: Metrisches Feingewinde - Zylindrisch
wd = Abdichtung durch Profildichtung - Viton

With Taper and O-ring - Viton
Cutting Ring Connection at the Tube Connection side
Thread: Metric - Parallel
wd = Sealing by an Elastomer Profiled Ring - Viton

Reihe Series	Druck Pressure PN	Rohr A.D. Tube O.D. D1	Gewinde Thread G	Ca. Maße Approx. Dimensions								Bestellzeichen Order-Code Standard	Brutto-Preis Gross-Price Euro (€)
				L1	L2	L3	L5	i	SW1	SW2	SW3		
L	500	6	M 10 x 1	27	12,0	34,5	26,0	8	14	12	14	EW-DKOL-06-M 10x1-wd	29,39
L	500	8	M 12 x 1,5	29	14,0	37,5	27,5	12	17	12	17	EW-DKOL-08-M 12x1,5-wd	31,33
L	500	10	M 14 x 1,5	30	15,0	40,0	29,0	12	19	14	19	EW-DKOL-10-M 14x1,5-wd	38,49
L	400	12	M 16 x 1,5	32	17,0	42,0	29,5	12	22	17	22	EW-DKOL-12-M 16x1,5-wd	43,56
L	400	15	M 18 x 1,5	36	21,0	46,0	32,5	12	24	19	27	EW-DKOL-15-M 18x1,5-wd	51,48
L	400	18	M 22 x 1,5	40	23,5	50,0	35,5	14	27	24	32	EW-DKOL-18-M 22x1,5-wd	75,44
L	250	22	M 26 x 1,5	44	27,5	55,0	38,5	16	32	27	36	EW-DKOL-22-M 26x1,5-wd	97,33
L	250	28	M 33 x 2	47	30,5	59,0	41,5	18	41	36	41	EW-DKOL-28-M 33x2-wd	150,68
L	250	35	M 42 x 2	56	34,5	68,5	51,0	20	50	41	50	EW-DKOL-35-M 42x2-wd	202,07
L	250	42	M 48 x 2	63	40,0	75,0	56,0	22	55	50	60	EW-DKOL-42-M 48x2-wd	299,80

Reihe Series	Druck Pressure PN	Rohr A.D. Tube O.D. D1	Gewinde Thread G	Ca. Maße Approx. Dimensions								Bestellzeichen Order-Code Standard	Brutto-Preis Gross-Price Euro (€)
				L1	L2	L3	L5	i	SW1	SW2	SW3		
S	800	6	M 12 x 1,5	31	16,0	40,0	27,0	12	17	12	17	EW-DKOS-06-M 12x1,5-wd	35,10
S	800	8	M 14 x 1,5	32	17,0	42,5	27,5	12	19	14	19	EW-DKOS-08-M 14x1,5-wd	39,40
S	800	10	M 16 x 1,5	34	17,5	45,0	30,0	12	22	17	22	EW-DKOS-10-M 16x1,5-wd	45,84
S	630	12	M 18 x 1,5	38	21,5	48,0	31,0	12	24	17	24	EW-DKOS-12-M 18x1,5-wd	51,59
S	630	14	M 20 x 1,5	40	22,0	54,0	35,0	14	27	19	27	EW-DKOS-14-M 20x1,5-wd	62,35
S	630	16	M 22 x 1,5	43	24,5	55,0	36,5	14	27	24	30	EW-DKOS-16-M 22x1,5-wd	78,71
S	420	20	M 27 x 2	48	26,5	65,0	44,5	16	32	27	36	EW-DKOS-20-M 27x2-wd	103,79
S	420	25	M 33 x 2	54	30,0	73,0	50,0	18	41	36	46	EW-DKOS-25-M 33x2-wd	165,97
S	420	30	M 42 x 2	62	35,5	78,5	55,0	20	50	41	50	EW-DKOS-30-M 42x2-wd	219,68
S	420	38	M 48 x 2	72	41,0	89,0	63,0	22	55	50	60	EW-DKOS-38-M 48x2-wd	309,16

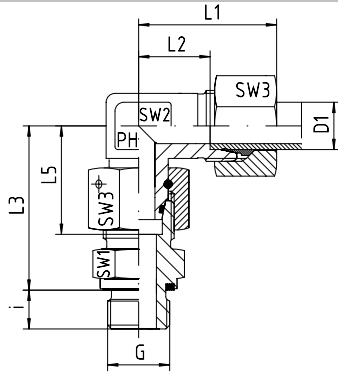

Einstellbare Winkelverschraubungen mit Dichtkegel und O-Ring Viton
Rohrseitig Schneidringanschluss
Einschraubgewinde: Metrisches Feingewinde - Zylindrisch
wd = Abdichtung durch Profildichtung - Viton

With Taper and O-ring - Viton
Cutting Ring Connection at the Tube Connection side
Thread: Metric - Parallel
wd = Sealing by an Elastomer Profiled Ring - Viton

Reihe Series	Druck Pressure PN	Rohr A.D. Tube O.D. D1	Gewinde Thread G	Ca. Maße Approx. Dimensions								Bestellzeichen Order-Code SC	Brutto-Preis Gross-Price Euro (€)
				L1	L2	L3	L5	i	SW1	SW2	SW3		
L	500	6	M 10 x 1	27	12,0	34,5	26,0	8	14	12	14	EW-DKOL-06-M 10x1-wd-SC	29,71
L	500	8	M 12 x 1,5	29	14,0	37,5	27,5	12	17	12	17	EW-DKOL-08-M 12x1,5-wd-SC	31,77
L	500	10	M 14 x 1,5	30	15,0	40,0	29,0	12	19	14	19	EW-DKOL-10-M 14x1,5-wd-SC	38,93
L	400	12	M 16 x 1,5	32	17,0	42,0	29,5	12	22	17	22	EW-DKOL-12-M 16x1,5-wd-SC	44,12
L	400	15	M 18 x 1,5	36	21,0	46,0	32,5	12	24	19	27	EW-DKOL-15-M 18x1,5-wd-SC	52,56
L	400	18	M 22 x 1,5	40	23,5	50,0	35,5	14	27	24	32	EW-DKOL-18-M 22x1,5-wd-SC	77,08
L	250	22	M 26 x 1,5	44	27,5	55,0	38,5	16	32	27	36	EW-DKOL-22-M 26x1,5-wd-SC	99,09
L	250	28	M 33 x 2	47	30,5	59,0	41,5	18	41	36	41	EW-DKOL-28-M 33x2-wd-SC	152,68
L	250	35	M 42 x 2	56	34,5	68,5	51,0	20	50	41	50	EW-DKOL-35-M 42x2-wd-SC	205,79
L	250	42	M 48 x 2	63	40,0	75,0	56,0	22	55	50	60	EW-DKOL-42-M 48x2-wd-SC	304,12

Reihe Series	Druck Pressure PN	Rohr A.D. Tube O.D. D1	Gewinde Thread G	Ca. Maße Approx. Dimensions								Bestellzeichen Order-Code SC	Brutto-Preis Gross-Price Euro (€)
				L1	L2	L3	L5	i	SW1	SW2	SW3		
S	800	6	M 12 x 1,5	31	16,0	40,0	27,0	12	17	12	17	EW-DKOS-06-M 12x1,5-wd-SC	35,54
S	800	8	M 14 x 1,5	32	17,0	42,5	27,5	12	19	14	19	EW-DKOS-08-M 14x1,5-wd-SC	39,84
S	800	10	M 16 x 1,5	34	17,5	45,0	30,0	12	22	17	22	EW-DKOS-10-M 16x1,5-wd-SC	46,40
S	630	12	M 18 x 1,5	38	21,5	48,0	31,0	12	24	17	24	EW-DKOS-12-M 18x1,5-wd-SC	52,43
S	630	14	M 20 x 1,5	40	22,0	54,0	35,0	14	27	19	27	EW-DKOS-14-M 20x1,5-wd-SC	63,91
S	630	16	M 22 x 1,5	43	24,5	55,0	36,5	14	27	24	30	EW-DKOS-16-M 22x1,5-wd-SC	80,27
S	420	20	M 27 x 2	48	26,5	65,0	44,5	16	32	27	36	EW-DKOS-20-M 27x2-wd-SC	105,67
S	420	25	M 33 x 2	54	30,0	73,0	50,0	18	41	36	46	EW-DKOS-25-M 33x2-wd-SC	168,97
S	420	30	M 42 x 2	62	35,5	78,5	55,0	20	50	41	50	EW-DKOS-30-M 42x2-wd-SC	223,84
S	420	38	M 48 x 2	72	41,0	89,0	63,0	22	55	50	60	EW-DKOS-38-M 48x2-wd-SC	314,80



Einstellbare Winkelverschraubungen mit Dichtkegel und O-Ring Viton
Rohrseitig Schneidringanschluss
Einschraubgewinde: Metrisches Feingewinde - Zylindrisch
wd = Abdichtung durch Profildichtung - Viton

With Taper and O-ring - Viton
Cutting Ring Connection at the Tube Connection side
Thread: Metric - Parallel
wd = Sealing by an Elastomer Profiled Ring - Viton

Reihe Series	Druck Pressure PN	Rohr A.D. Tube O.D. D1	Gewinde Thread G	Ca. Maße Approx. Dimensions						Bestellzeichen Order-Code OMD	Brutto-Preis Gross-Price Euro (€)
L	500	6	M 10 x 1							EW-DKOL-06-M 10x1-wd-OMD	27,08
L	500	8	M 12 x 1,5							EW-DKOL-08-M 12x1,5-wd-OMD	28,53
L	500	10	M 14 x 1,5							EW-DKOL-10-M 14x1,5-wd-OMD	35,13
L	400	12	M 16 x 1,5							EW-DKOL-12-M 16x1,5-wd-OMD	39,67
L	400	15	M 18 x 1,5							EW-DKOL-15-M 18x1,5-wd-OMD	46,34
L	400	18	M 22 x 1,5							EW-DKOL-18-M 22x1,5-wd-OMD	66,82
L	250	22	M 26 x 1,5							EW-DKOL-22-M 26x1,5-wd-OMD	87,02
L	250	28	M 33 x 2							EW-DKOL-28-M 33x2-wd-OMD	135,83
L	250	35	M 42 x 2							EW-DKOL-35-M 42x2-wd-OMD	180,96
L	250	42	M 48 x 2							EW-DKOL-42-M 48x2-wd-OMD	272,37

Reihe Series	Druck Pressure PN	Rohr A.D. Tube O.D. D1	Gewinde Thread G	Ca. Maße Approx. Dimensions						Bestellzeichen Order-Code OMD	Brutto-Preis Gross-Price Euro (€)
S	800	6	M 12 x 1,5							EW-DKOS-06-M 12x1,5-wd-OMD	32,31
S	800	8	M 14 x 1,5							EW-DKOS-08-M 14x1,5-wd-OMD	36,20
S	800	10	M 16 x 1,5							EW-DKOS-10-M 16x1,5-wd-OMD	41,90
S	630	12	M 18 x 1,5							EW-DKOS-12-M 18x1,5-wd-OMD	47,14
S	630	14	M 20 x 1,5							EW-DKOS-14-M 20x1,5-wd-OMD	56,85
S	630	16	M 22 x 1,5							EW-DKOS-16-M 22x1,5-wd-OMD	70,50
S	420	20	M 27 x 2							EW-DKOS-20-M 27x2-wd-OMD	93,21
S	420	25	M 33 x 2							EW-DKOS-25-M 33x2-wd-OMD	147,35
S	420	30	M 42 x 2							EW-DKOS-30-M 42x2-wd-OMD	196,24
S	420	38	M 48 x 2							EW-DKOS-38-M 48x2-wd-OMD	277,35

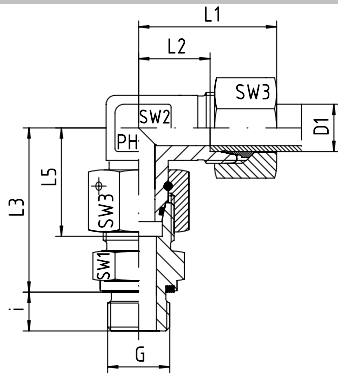

Einstellbare Winkelverschraubungen mit Dichtkegel und O-Ring Viton
Rohrseitig Schneidringanschluss
Einschraubgewinde: Whitworth-Rohrgewinde - Zylindrisch
wd = Abdichtung durch Profildichtung - Viton

With Taper and O-ring - Viton
Cutting Ring Connection at the Tube Connection side
Thread: BSP - Parallel
wd = Sealing by an Elastomer Profiled Ring - Viton

Reihe Series	Druck Pressure PN	Rohr A.D. Tube O.D. D1	Gewinde Thread G	Ca. Maße Approx. Dimensions								Bestellzeichen Order-Code Standard	Brutto-Preis Gross-Price Euro (€)
				L1	L2	L3	L5	i	SW1	SW2	SW3		
L	500	6	G 1/8"	27	12,0	34,5	26,0	8	14	12	14	EW-DKOL-06-G 1/8"-wd	29,39
L	500	8	G 1/4"	29	14,0	37,5	27,5	12	17	12	17	EW-DKOL-08-G 1/4"-wd	30,92
L	500	10	G 1/4"	30	15,0	40,0	29,0	12	19	14	19	EW-DKOL-10-G 1/4"-wd	38,54
L	400	12	G 1/4"	32	17,0	42,0	29,5	12	19	17	22	EW-DKOL-12-G 1/4"-wd	45,60
L	400	12	G 3/8"	32	17,0	42,0	29,5	12	22	17	22	EW-DKOL-12-G 3/8"-wd	42,82
L	400	12	G 1/2"	32	17,0	43,0	29,5	14	27	17	22	EW-DKOL-12-G 1/2"-wd	49,28
L	400	15	G 1/2"	36	21,0	46,0	32,5	14	27	19	27	EW-DKOL-15-G 1/2"-wd	52,07
L	400	18	G 1/2"	40	23,5	50,0	35,5	14	27	24	32	EW-DKOL-18-G 1/2"-wd	74,11
L	250	22	G 3/4"	44	27,5	55,0	38,5	16	32	27	36	EW-DKOL-22-G 3/4"-wd	94,97
L	250	28	G 1"	47	30,5	59,0	41,5	18	41	36	41	EW-DKOL-28-G 1"-wd	150,19
L	250	35	G 1 1/4"	56	34,5	68,5	51,0	20	50	41	50	EW-DKOL-35-G 1 1/4"-wd	202,83
L	250	42	G 1 1/2"	63	40,0	75,0	56,0	22	55	50	60	EW-DKOL-42-G 1 1/2"-wd	299,80

Reihe Series	Druck Pressure PN	Rohr A.D. Tube O.D. D1	Gewinde Thread G	Ca. Maße Approx. Dimensions								Bestellzeichen Order-Code Standard	Brutto-Preis Gross-Price Euro (€)
				L1	L2	L3	L5	i	SW1	SW2	SW3		
S	800	6	G 1/4"	31	16,0	40,0	27,0	12	19	12	17	EW-DKOS-06-G 1/4"-wd	34,21
S	800	8	G 1/4"	32	17,0	42,5	27,5	12	19	14	19	EW-DKOS-08-G 1/4"-wd	36,66
S	800	10	G 3/8"	34	17,5	45,0	30,0	12	22	17	22	EW-DKOS-10-G 3/8"-wd	44,43
S	630	12	G 3/8"	38	21,5	48,0	31,0	12	22	17	24	EW-DKOS-12-G 3/8"-wd	50,34
S	630	12	G 1/2"	38	21,5	49,0	31,0	14	27	17	24	EW-DKOS-12-G 1/2"-wd	56,06
S	630	14	G 1/2"	40	22,0	54,0	35,0	14	27	19	27	EW-DKOS-14-G 1/2"-wd	62,33
S	630	16	G 1/2"	43	24,5	55,0	36,5	14	27	24	30	EW-DKOS-16-G 1/2"-wd	80,25
S	420	20	G 3/4"	48	26,5	65,0	44,5	16	32	27	36	EW-DKOS-20-G 3/4"-wd	102,82
S	420	25	G 1"	54	30,0	73,0	50,0	18	41	36	46	EW-DKOS-25-G 1"-wd	166,48
S	420	30	G 1 1/4"	62	35,5	78,5	55,0	20	50	41	50	EW-DKOS-30-G 1 1/4"-wd	219,68
S	420	38	G 1 1/2"	72	41,0	89,0	63,0	22	55	50	60	EW-DKOS-38-G 1 1/2"-wd	309,54

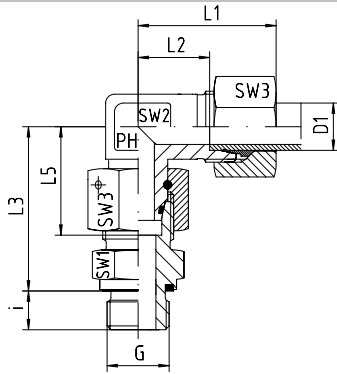

Einstellbare Winkelverschraubungen mit Dichtkegel und O-Ring Viton
Rohrseitig Schneidringanschluss
Einschraubgewinde: Whitworth-Rohrgewinde - Zylindrisch
wd = Abdichtung durch Profildichtung - Viton

With Taper and O-ring - Viton
Cutting Ring Connection at the Tube Connection side
Thread: BSP - Parallel
wd = Sealing by an Elastomer Profiled Ring - Viton

Reihe Series	Druck Pressure PN	Rohr A.D. Tube O.D. D1	Gewinde Thread G	Ca. Maße Approx. Dimensions								Bestellzeichen Order-Code SC	Brutto-Preis Gross-Price Euro (€)
				L1	L2	L3	L5	i	SW1	SW2	SW3		
L	500	6	G 1/8"	27	12,0	34,5	26,0	8	14	12	14	EW-DKOL-06-G 1/8"-wd-SC	29,71
L	500	8	G 1/4"	29	14,0	37,5	27,5	12	17	12	17	EW-DKOL-08-G 1/4"-wd-SC	31,36
L	500	10	G 1/4"	30	15,0	40,0	29,0	12	19	14	19	EW-DKOL-10-G 1/4"-wd-SC	38,98
L	400	12	G 1/4"	32	17,0	42,0	29,5	12	19	17	22	EW-DKOL-12-G 1/4"-wd-SC	46,16
L	400	12	G 3/8"	32	17,0	42,0	29,5	12	22	17	22	EW-DKOL-12-G 3/8"-wd-SC	43,38
L	400	12	G 1/2"	32	17,0	43,0	29,5	14	27	17	22	EW-DKOL-12-G 1/2"-wd-SC	49,84
L	400	15	G 1/2"	36	21,0	46,0	32,5	14	27	19	27	EW-DKOL-15-G 1/2"-wd-SC	53,15
L	400	18	G 1/2"	40	23,5	50,0	35,5	14	27	24	32	EW-DKOL-18-G 1/2"-wd-SC	75,75
L	250	22	G 3/4"	44	27,5	55,0	38,5	16	32	27	36	EW-DKOL-22-G 3/4"-wd-SC	96,73
L	250	28	G 1"	47	30,5	59,0	41,5	18	41	36	41	EW-DKOL-28-G 1"-wd-SC	152,19
L	250	35	G 1 1/4"	56	34,5	68,5	51,0	20	50	41	50	EW-DKOL-35-G 1 1/4"-wd-SC	206,55
L	250	42	G 1 1/2"	63	40,0	75,0	56,0	22	55	50	60	EW-DKOL-42-G 1 1/2"-wd-SC	304,12

Reihe Series	Druck Pressure PN	Rohr A.D. Tube O.D. D1	Gewinde Thread G	Ca. Maße Approx. Dimensions								Bestellzeichen Order-Code SC	Brutto-Preis Gross-Price Euro (€)
				L1	L2	L3	L5	i	SW1	SW2	SW3		
S	800	6	G 1/4"	31	16,0	40,0	27,0	12	19	12	17	EW-DKOS-06-G 1/4"-wd-SC	34,65
S	800	8	G 1/4"	32	17,0	42,5	27,5	12	19	14	19	EW-DKOS-08-G 1/4"-wd-SC	37,10
S	800	10	G 3/8"	34	17,5	45,0	30,0	12	22	17	22	EW-DKOS-10-G 3/8"-wd-SC	44,99
S	630	12	G 3/8"	38	21,5	48,0	31,0	12	22	17	24	EW-DKOS-12-G 3/8"-wd-SC	51,18
S	630	12	G 1/2"	38	21,5	49,0	31,0	14	27	17	24	EW-DKOS-12-G 1/2"-wd-SC	56,90
S	630	14	G 1/2"	40	22,0	54,0	35,0	14	27	19	27	EW-DKOS-14-G 1/2"-wd-SC	63,89
S	630	16	G 1/2"	43	24,5	55,0	36,5	14	27	24	30	EW-DKOS-16-G 1/2"-wd-SC	81,81
S	420	20	G 3/4"	48	26,5	65,0	44,5	16	32	27	36	EW-DKOS-20-G 3/4"-wd-SC	104,70
S	420	25	G 1"	54	30,0	73,0	50,0	18	41	36	46	EW-DKOS-25-G 1"-wd-SC	169,48
S	420	30	G 1 1/4"	62	35,5	78,5	55,0	20	50	41	50	EW-DKOS-30-G 1 1/4"-wd-SC	223,84
S	420	38	G 1 1/2"	72	41,0	89,0	63,0	22	55	50	60	EW-DKOS-38-G 1 1/2"-wd-SC	315,18



Einstellbare Winkelverschraubungen mit Dichtkegel und O-Ring Viton

Rohrseitig Schneidringanschluss

Einschraubgewinde: Whitworth-Rohrgewinde - Zylindrisch
wd = Abdichtung durch Profildichtung - Viton

With Taper and O-ring - Viton

Cutting Ring Connection at the Tube Connection side

Thread: BSP - Parallel

wd = Sealing by an Elastomer Profiled Ring - Viton

Reihe Series	Druck Pressure PN	Rohr A.D. Tube O.D. D1	Gewinde Thread G	Ca. Maße Approx. Dimensions						Bestellzeichen Order-Code OMD	Brutto-Preis Gross-Price Euro (€)
L	500	6	G 1/8"							EW-DKOL-06-G 1/8"-wd-OMD	27,08
L	500	8	G 1/4"							EW-DKOL-08-G 1/4"-wd-OMD	28,12
L	500	10	G 1/4"							EW-DKOL-10-G 1/4"-wd-OMD	35,18
L	400	12	G 1/4"							EW-DKOL-12-G 1/4"-wd-OMD	41,71
L	400	12	G 3/8"							EW-DKOL-12-G 3/8"-wd-OMD	38,93
L	400	12	G 1/2"							EW-DKOL-12-G 1/2"-wd-OMD	45,39
L	400	15	G 1/2"							EW-DKOL-15-G 1/2"-wd-OMD	46,93
L	400	18	G 1/2"							EW-DKOL-18-G 1/2"-wd-OMD	65,49
L	250	22	G 3/4"							EW-DKOL-22-G 3/4"-wd-OMD	84,66
L	250	28	G 1"							EW-DKOL-28-G 1"-wd-OMD	135,34
L	250	35	G 1 1/4"							EW-DKOL-35-G 1 1/4"-wd-OMD	181,72
L	250	42	G 1 1/2"							EW-DKOL-42-G 1 1/2"-wd-OMD	272,37

Reihe Series	Druck Pressure PN	Rohr A.D. Tube O.D. D1	Gewinde Thread G	Ca. Maße Approx. Dimensions						Bestellzeichen Order-Code OMD	Brutto-Preis Gross-Price Euro (€)
S	800	6	G 1/4"							EW-DKOS-06-G 1/4"-wd-OMD	31,42
S	800	8	G 1/4"							EW-DKOS-08-G 1/4"-wd-OMD	33,46
S	800	10	G 3/8"							EW-DKOS-10-G 3/8"-wd-OMD	40,49
S	630	12	G 3/8"							EW-DKOS-12-G 3/8"-wd-OMD	45,89
S	630	12	G 1/2"							EW-DKOS-12-G 1/2"-wd-OMD	51,61
S	630	14	G 1/2"							EW-DKOS-14-G 1/2"-wd-OMD	56,83
S	630	16	G 1/2"							EW-DKOS-16-G 1/2"-wd-OMD	72,04
S	420	20	G 3/4"							EW-DKOS-20-G 3/4"-wd-OMD	92,24
S	420	25	G 1"							EW-DKOS-25-G 1"-wd-OMD	147,86
S	420	30	G 1 1/4"							EW-DKOS-30-G 1 1/4"-wd-OMD	196,24
S	420	38	G 1 1/2"							EW-DKOS-38-G 1 1/2"-wd-OMD	277,73

EV-VERSCHRAUBUNGEN - 45° ADJUSTABLE STUD ELBOWS - 45°

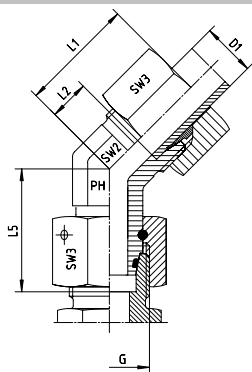

Einstellbare Winkelverschraubungen mit Dichtkegel
und O-Ring Viton
Rohrseitig Schneidringanschluss

*With Taper and O-ring - Viton
Cutting Ring Connection at the Tube Connection side*

Reihe Series	Druck Pressure PN	Rohr A.D. Tube O.D. D1	Gewinde Thread G	Ca. Maße Approx. Dimensions					Bestellzeichen Order-Code Standard	Brutto-Preis Gross-Price Euro (€)
				L1	L2	L5	SW2	SW3		
L	500	6	M 12 x 1,5	24	9,0	26,0	14	14	EV-DKOL-06	31,76
L	500	8	M 14 x 1,5	27	12,0	27,5	14	17	EV-DKOL-08	35,00
L	500	10	M 16 x 1,5	27	12,0	29,0	19	19	EV-DKOL-10	42,81
L	400	12	M 18 x 1,5	29	14,0	29,5	19	22	EV-DKOL-12	50,12
L	400	15	M 22 x 1,5	32	17,0	32,5	22	27	EV-DKOL-15	52,24
L	400	18	M 26 x 1,5	33	16,5	35,5	27	32	EV-DKOL-18	102,37
L	250	22	M 30 x 2	35	18,5	38,5	30	36	EV-DKOL-22	131,36
L	250	28	M 36 x 2	40	23,0	41,5	36	41	EV-DKOL-28	182,25
L	250	35	M 45 x 2	48	26,5	51,0	50	50	EV-DKOL-35	259,88
L	250	42	M 52 x 2	49	26,0	56,0	50	60	EV-DKOL-42	383,83

Reihe Series	Druck Pressure PN	Rohr A.D. Tube O.D. D1	Gewinde Thread G	Ca. Maße Approx. Dimensions					Bestellzeichen Order-Code Standard	Brutto-Preis Gross-Price Euro (€)
				L1	L2	L5	SW2	SW3		
S	800	6	M 14 x 1,5	24	9,0	27,0	14	17	EV-DKOS-06	34,99
S	800	8	M 16 x 1,5	27	12,0	27,5	19	19	EV-DKOS-08	42,65
S	800	10	M 18 x 1,5	30	13,5	30,0	19	22	EV-DKOS-10	50,17
S	630	12	M 20 x 1,5	33	16,5	31,0	22	24	EV-DKOS-12	51,45
S	630	16	M 24 x 1,5	34	15,5	36,5	27	30	EV-DKOS-16	98,31
S	420	20	M 30 x 2	38	16,0	44,5	30	36	EV-DKOS-20	131,63
S	420	25	M 36 x 2	43	18,5	50,0	36	46	EV-DKOS-25	190,62
S	420	30	M 42 x 2	50	23,5	55,0	50	50	EV-DKOS-30	262,21
S	420	38	M 52 x 2	52	21,0	63,0	50	60	EV-DKOS-38	452,01

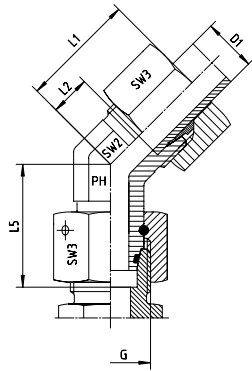

Einstellbare Winkelverschraubungen mit Dichtkegel
und O-Ring Viton
Rohrseitig Schneidringanschluss

*With Taper and O-ring - Viton
Cutting Ring Connection at the Tube Connection side*

Reihe Series	Druck Pressure PN	Rohr A.D. Tube O.D. D1	Gewinde Thread G	Ca. Maße Approx. Dimensions					Bestellzeichen Order-Code SC	Brutto-Preis Gross-Price Euro (€)
				L1	L2	L5	SW2	SW3		
L	500	6	M 12 x 1,5	24	9,0	26,0	14	14	EV-DKOL-06-SC	32,18
L	500	8	M 14 x 1,5	27	12,0	27,5	14	17	EV-DKOL-08-SC	35,57
L	500	10	M 16 x 1,5	27	12,0	29,0	19	19	EV-DKOL-10-SC	43,39
L	400	12	M 18 x 1,5	29	14,0	29,5	19	22	EV-DKOL-12-SC	50,85
L	400	15	M 22 x 1,5	32	17,0	32,5	22	27	EV-DKOL-15-SC	53,56
L	400	18	M 26 x 1,5	33	16,5	35,5	27	32	EV-DKOL-18-SC	104,45
L	250	22	M 30 x 2	35	18,5	38,5	30	36	EV-DKOL-22-SC	133,64
L	250	28	M 36 x 2	40	23,0	41,5	36	41	EV-DKOL-28-SC	184,96
L	250	35	M 45 x 2	48	26,5	51,0	50	50	EV-DKOL-35-SC	264,65
L	250	42	M 52 x 2	49	26,0	56,0	50	60	EV-DKOL-42-SC	389,52

Reihe Series	Druck Pressure PN	Rohr A.D. Tube O.D. D1	Gewinde Thread G	Ca. Maße Approx. Dimensions					Bestellzeichen Order-Code SC	Brutto-Preis Gross-Price Euro (€)
				L1	L2	L5	SW2	SW3		
S	800	6	M 14 x 1,5	24	9,0	27,0	14	17	EV-DKOS-06-SC	35,56
S	800	8	M 16 x 1,5	27	12,0	27,5	19	19	EV-DKOS-08-SC	43,24
S	800	10	M 18 x 1,5	30	13,5	30,0	19	22	EV-DKOS-10-SC	50,91
S	630	12	M 20 x 1,5	33	16,5	31,0	22	24	EV-DKOS-12-SC	52,50
S	630	16	M 24 x 1,5	34	15,5	36,5	27	30	EV-DKOS-16-SC	101,09
S	420	20	M 30 x 2	38	16,0	44,5	30	36	EV-DKOS-20-SC	134,05
S	420	25	M 36 x 2	43	18,5	50,0	36	46	EV-DKOS-25-SC	194,58
S	420	30	M 42 x 2	50	23,5	55,0	50	50	EV-DKOS-30-SC	267,57
S	420	38	M 52 x 2	52	21,0	63,0	50	60	EV-DKOS-38-SC	459,33

EV-VERSCHRAUBUNGEN - 45° ADJUSTABLE STUD ELBOWS - 45°



EDELSTAHL / STAINLESS STEEL
VERBINDUNGSTECHNIK
FLUID CONNECTORS



Einstellbare Winkelverschraubungen mit Dichtkegel
und O-Ring Viton
Rohrseitig Schneidringanschluss

*With Taper and O-ring - Viton
Cutting Ring Connection at the Tube Connection side*

Reihe Series	Druck Pressure PN	Rohr A.D. Tube O.D. D1	Gewinde Thread G	Ca. Maße Approx. Dimensions				Bestellzeichen Order-Code OMD	Brutto-Preis Gross-Price Euro (€)
L	500	6	M 12 x 1,5					EV-DKOL-06-OMD	29,45
L	500	8	M 14 x 1,5					EV-DKOL-08-OMD	32,20
L	500	10	M 16 x 1,5					EV-DKOL-10-OMD	39,45
L	400	12	M 18 x 1,5					EV-DKOL-12-OMD	46,23
L	400	15	M 22 x 1,5					EV-DKOL-15-OMD	47,10
L	400	18	M 26 x 1,5					EV-DKOL-18-OMD	93,75
L	250	22	M 30 x 2					EV-DKOL-22-OMD	121,05
L	250	28	M 36 x 2					EV-DKOL-28-OMD	167,40
L	250	35	M 45 x 2					EV-DKOL-35-OMD	238,77
L	250	42	M 52 x 2					EV-DKOL-42-OMD	356,40

Reihe Series	Druck Pressure PN	Rohr A.D. Tube O.D. D1	Gewinde Thread G	Ca. Maße Approx. Dimensions				Bestellzeichen Order-Code OMD	Brutto-Preis Gross-Price Euro (€)
S	800	6	M 14 x 1,5					EV-DKOS-06-OMD	32,20
S	800	8	M 16 x 1,5					EV-DKOS-08-OMD	39,45
S	800	10	M 18 x 1,5					EV-DKOS-10-OMD	46,23
S	630	12	M 20 x 1,5					EV-DKOS-12-OMD	47,00
S	630	16	M 24 x 1,5					EV-DKOS-16-OMD	90,10
S	420	20	M 30 x 2					EV-DKOS-20-OMD	121,05
S	420	25	M 36 x 2					EV-DKOS-25-OMD	172,00
S	420	30	M 42 x 2					EV-DKOS-30-OMD	238,77
S	420	38	M 52 x 2					EV-DKOS-38-OMD	420,20

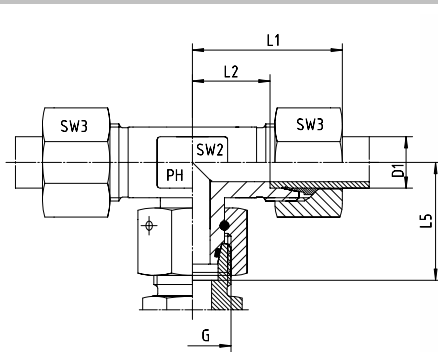

Einstellbare T-Verschraubungen mit Dichtkegel und O-Ring Viton
Rohrseitig Schneidringanschluss

*With Taper and O-ring - Viton
Cutting Ring Connection at the Tube Connection side*

Reihe Series	Druck Pressure PN	Rohr A.D. Tube O.D. D1	Gewinde Thread G	Ca. Maße Approx. Dimensions					Bestellzeichen Order-Code Standard	Brutto-Preis Gross-Price Euro (€)
				L1	L2	L5	SW2	SW3		
L	500	6	M 12 x 1,5	27	12,0	26,0	12	14	ET-DKOL-06	37,91
L	500	8	M 14 x 1,5	29	14,0	27,5	12	17	ET-DKOL-08	39,19
L	500	10	M 16 x 1,5	30	15,0	29,0	14	19	ET-DKOL-10	48,39
L	400	12	M 18 x 1,5	32	17,0	29,5	17	22	ET-DKOL-12	53,15
L	400	15	M 22 x 1,5	36	21,0	32,5	19	27	ET-DKOL-15	71,58
L	400	18	M 26 x 1,5	40	23,5	35,5	24	32	ET-DKOL-18	94,59
L	250	22	M 30 x 2	44	27,5	38,5	27	36	ET-DKOL-22	109,93
L	250	28	M 36 x 2	47	30,5	41,5	36	41	ET-DKOL-28	191,74
L	250	35	M 45 x 2	56	34,5	51,0	41	50	ET-DKOL-35	281,21
L	250	42	M 52 x 2	63	40,0	56,0	50	60	ET-DKOL-42	375,81

Reihe Series	Druck Pressure PN	Rohr A.D. Tube O.D. D1	Gewinde Thread G	Ca. Maße Approx. Dimensions					Bestellzeichen Order-Code Standard	Brutto-Preis Gross-Price Euro (€)
				L1	L2	L5	SW2	SW3		
S	800	6	M 14 x 1,5	31	16,0	27,0	12	17	ET-DKOS-06	39,45
S	800	8	M 16 x 1,5	32	17,0	27,5	14	19	ET-DKOS-08	42,77
S	800	10	M 18 x 1,5	34	17,5	30,0	17	22	ET-DKOS-10	53,38
S	630	12	M 20 x 1,5	38	21,5	31,0	17	24	ET-DKOS-12	58,29
S	630	14	M 22 x 1,5	40	22,0	35,0	19	27	ET-DKOS-14	74,14
S	630	16	M 24 x 1,5	43	24,5	36,5	24	30	ET-DKOS-16	94,59
S	420	20	M 30 x 2	48	26,5	44,5	27	36	ET-DKOS-20	120,16
S	420	25	M 36 x 2	54	30,0	50,0	36	46	ET-DKOS-25	191,74
S	420	30	M 42 x 2	62	35,5	55,0	41	50	ET-DKOS-30	250,54
S	420	38	M 52 x 2	72	41,0	63,0	50	60	ET-DKOS-38	383,47

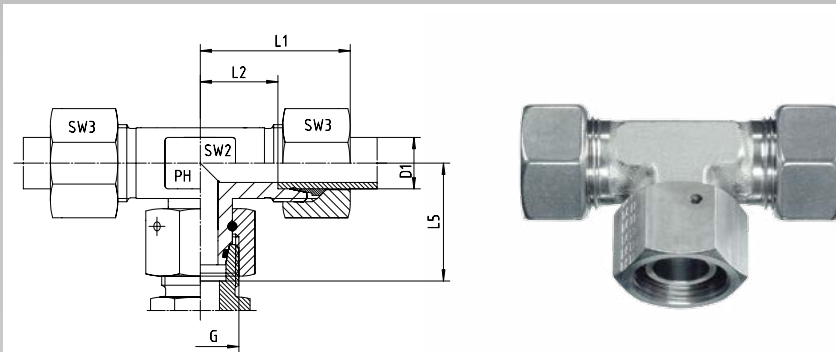

Einstellbare T-Verschraubungen mit Dichtkegel und O-Ring Viton
Rohrseitig Schneidringanschluss

*With Taper and O-ring - Viton
Cutting Ring Connection at the Tube Connection side*

Reihe Series	Druck Pressure PN	Rohr A.D. Tube O.D. D1	Gewinde Thread G	Ca. Maße Approx. Dimensions					Bestellzeichen Order-Code SC	Brutto-Preis Gross-Price Euro (€)
				L1	L2	L5	SW2	SW3		
L	500	6	M 12 x 1,5	27	12,0	26,0	12	14	ET-DKOL-06-SC	38,55
L	500	8	M 14 x 1,5	29	14,0	27,5	12	17	ET-DKOL-08-SC	40,07
L	500	10	M 16 x 1,5	30	15,0	29,0	14	19	ET-DKOL-10-SC	49,27
L	400	12	M 18 x 1,5	32	17,0	29,5	17	22	ET-DKOL-12-SC	54,27
L	400	15	M 22 x 1,5	36	21,0	32,5	19	27	ET-DKOL-15-SC	73,74
L	400	18	M 26 x 1,5	40	23,5	35,5	24	32	ET-DKOL-18-SC	97,87
L	250	22	M 30 x 2	44	27,5	38,5	27	36	ET-DKOL-22-SC	113,45
L	250	28	M 36 x 2	47	30,5	41,5	36	41	ET-DKOL-28-SC	195,74
L	250	35	M 45 x 2	56	34,5	51,0	41	50	ET-DKOL-35-SC	288,65
L	250	42	M 52 x 2	63	40,0	56,0	50	60	ET-DKOL-42-SC	384,45

Reihe Series	Druck Pressure PN	Rohr A.D. Tube O.D. D1	Gewinde Thread G	Ca. Maße Approx. Dimensions					Bestellzeichen Order-Code SC	Brutto-Preis Gross-Price Euro (€)
				L1	L2	L5	SW2	SW3		
S	800	6	M 14 x 1,5	31	16,0	27,0	12	17	ET-DKOS-06-SC	40,33
S	800	8	M 16 x 1,5	32	17,0	27,5	14	19	ET-DKOS-08-SC	43,65
S	800	10	M 18 x 1,5	34	17,5	30,0	17	22	ET-DKOS-10-SC	54,50
S	630	12	M 20 x 1,5	38	21,5	31,0	17	24	ET-DKOS-12-SC	59,97
S	630	14	M 22 x 1,5	40	22,0	35,0	19	27	ET-DKOS-14-SC	77,26
S	630	16	M 24 x 1,5	43	24,5	36,5	24	30	ET-DKOS-16-SC	97,71
S	420	20	M 30 x 2	48	26,5	44,5	27	36	ET-DKOS-20-SC	123,92
S	420	25	M 36 x 2	54	30,0	50,0	36	46	ET-DKOS-25-SC	197,74
S	420	30	M 42 x 2	62	35,5	55,0	41	50	ET-DKOS-30-SC	258,86
S	420	38	M 52 x 2	72	41,0	63,0	50	60	ET-DKOS-38-SC	394,75



Einstellbare T-Verschraubungen mit Dichtkegel und O-Ring Viton
Rohrseitig Schneidringanschluss

*With Taper and O-ring - Viton
Cutting Ring Connection at the Tube Connection side*

Reihe Series	Druck Pressure PN	Rohr A.D. Tube O.D. D1	Gewinde Thread G	Ca. Maße Approx. Dimensions				Bestellzeichen Order-Code OMD	Brutto-Preis Gross-Price Euro (€)
L	500	6	M 12 x 1,5					ET-DKOL-06-OMD	33,29
L	500	8	M 14 x 1,5					ET-DKOL-08-OMD	33,59
L	500	10	M 16 x 1,5					ET-DKOL-10-OMD	41,67
L	400	12	M 18 x 1,5					ET-DKOL-12-OMD	45,37
L	400	15	M 22 x 1,5					ET-DKOL-15-OMD	61,30
L	400	18	M 26 x 1,5					ET-DKOL-18-OMD	77,35
L	250	22	M 30 x 2					ET-DKOL-22-OMD	89,31
L	250	28	M 36 x 2					ET-DKOL-28-OMD	162,04
L	250	35	M 45 x 2					ET-DKOL-35-OMD	238,99
L	250	42	M 52 x 2					ET-DKOL-42-OMD	320,95

Reihe Series	Druck Pressure PN	Rohr A.D. Tube O.D. D1	Gewinde Thread G	Ca. Maße Approx. Dimensions				Bestellzeichen Order-Code OMD	Brutto-Preis Gross-Price Euro (€)
S	800	6	M 14 x 1,5					ET-DKOS-06-OMD	33,87
S	800	8	M 16 x 1,5					ET-DKOS-08-OMD	36,37
S	800	10	M 18 x 1,5					ET-DKOS-10-OMD	45,50
S	630	12	M 20 x 1,5					ET-DKOS-12-OMD	49,39
S	630	14	M 22 x 1,5					ET-DKOS-14-OMD	63,14
S	630	16	M 24 x 1,5					ET-DKOS-16-OMD	78,17
S	420	20	M 30 x 2					ET-DKOS-20-OMD	99,00
S	420	25	M 36 x 2					ET-DKOS-25-OMD	154,50
S	420	30	M 42 x 2					ET-DKOS-30-OMD	203,66
S	420	38	M 52 x 2					ET-DKOS-38-OMD	320,19

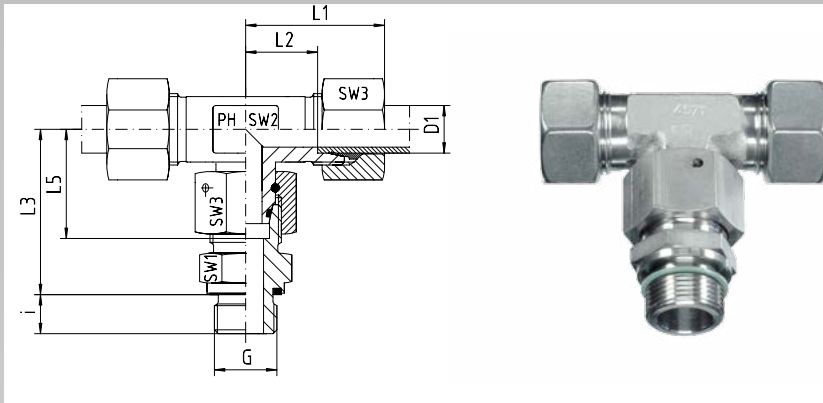

Einstellbare T-Verschraubungen mit Dichtkegel und O-Ring Viton
Rohrseitig Schneidringanschluss
Einschraubgewinde: Metrisches Feingewinde - Zylindrisch
wd = Abdichtung durch Profildichtung - Viton

With Taper and O-ring - Viton
Cutting Ring Connection at the Tube Connection side
Thread: Metric - Parallel
wd = Sealing by an Elastomer Profiled Ring - Viton

Reihe Series	Druck Pressure PN	Rohr A.D. Tube O.D. D1	Gewinde Thread G	Ca. Maße Approx. Dimensions								Bestellzeichen Order-Code Standard	Brutto-Preis Gross-Price Euro (€)
				L1	L2	L3	L5	i	SW1	SW2	SW3		
L	500	6	M 10 x 1	27	12,0	34,5	26,0	8	14	12	14	ET-DKOL-06-M 10x1-wd	43,53
L	500	8	M 12 x 1,5	29	14,0	37,5	27,5	12	17	12	17	ET-DKOL-08-M 12x1,5-wd	46,31
L	500	10	M 14 x 1,5	30	15,0	40,0	29,0	12	19	14	19	ET-DKOL-10-M 14x1,5-wd	55,41
L	400	12	M 16 x 1,5	32	17,0	42,0	29,5	12	22	17	22	ET-DKOL-12-M 16x1,5-wd	62,25
L	400	15	M 18 x 1,5	36	21,0	46,0	32,5	12	24	19	27	ET-DKOL-15-M 18x1,5-wd	82,77
L	400	18	M 22 x 1,5	40	23,5	50,0	35,5	14	27	24	32	ET-DKOL-18-M 22x1,5-wd	108,68
L	250	22	M 26 x 1,5	44	27,5	55,0	38,5	16	32	27	36	ET-DKOL-22-M 26x1,5-wd	130,56
L	250	28	M 33 x 2	47	30,5	59,0	41,5	18	41	36	41	ET-DKOL-28-M 33x2-wd	222,26
L	250	35	M 42 x 2	56	34,5	68,5	51,0	20	50	41	50	ET-DKOL-35-M 42x2-wd	314,55
L	250	42	M 48 x 2	63	40,0	75,0	56,0	22	55	50	60	ET-DKOL-42-M 48x2-wd	425,07

Reihe Series	Druck Pressure PN	Rohr A.D. Tube O.D. D1	Gewinde Thread G	Ca. Maße Approx. Dimensions								Bestellzeichen Order-Code Standard	Brutto-Preis Gross-Price Euro (€)
				L1	L2	L3	L5	i	SW1	SW2	SW3		
S	800	6	M 12 x 1,5	31	16,0	40,0	27,0	12	17	12	17	ET-DKOS-06-M 12x1,5-wd	48,39
S	800	8	M 14 x 1,5	32	17,0	42,5	27,5	12	19	14	19	ET-DKOS-08-M 14x1,5-wd	52,84
S	800	10	M 16 x 1,5	34	17,5	45,0	30,0	12	22	17	22	ET-DKOS-10-M 16x1,5-wd	63,84
S	630	12	M 18 x 1,5	38	21,5	48,0	31,0	12	24	17	24	ET-DKOS-12-M 18x1,5-wd	69,00
S	630	14	M 20 x 1,5	40	22,0	54,0	35,0	14	27	19	27	ET-DKOS-14-M 20x1,5-wd	87,38
S	630	16	M 22 x 1,5	43	24,5	55,0	36,5	14	27	24	30	ET-DKOS-16-M 22x1,5-wd	109,39
S	420	20	M 27 x 2	48	26,5	65,0	44,5	16	32	27	36	ET-DKOS-20-M 27x2-wd	142,14
S	420	25	M 33 x 2	54	30,0	73,0	50,0	18	41	36	46	ET-DKOS-25-M 33x2-wd	224,77
S	420	30	M 42 x 2	62	35,5	78,5	55,0	20	50	41	50	ET-DKOS-30-M 42x2-wd	288,71
S	420	38	M 48 x 2	72	41,0	89,0	63,0	22	55	50	60	ET-DKOS-38-M 48x2-wd	429,31

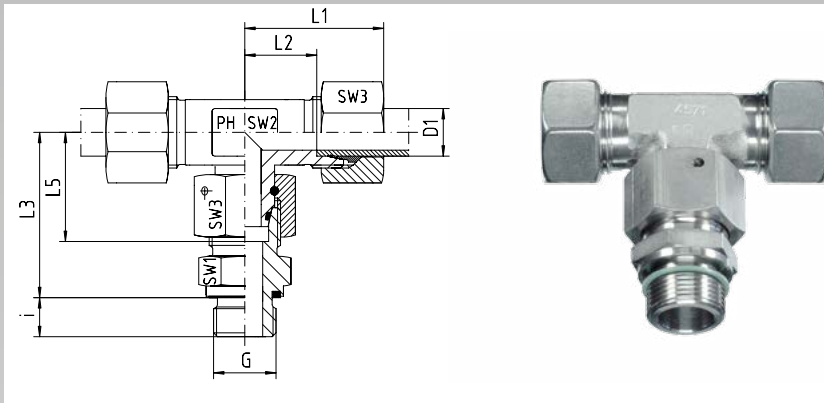

Einstellbare T-Verschraubungen mit Dichtkegel und O-Ring Viton
Rohrseitig Schneidringanschluss
Einschraubgewinde: Metrisches Feingewinde - Zylindrisch
wd = Abdichtung durch Profildichtung - Viton

With Taper and O-ring - Viton
Cutting Ring Connection at the Tube Connection side
Thread: Metric - Parallel
wd = Sealing by an Elastomer Profiled Ring - Viton

Reihe Series	Druck Pressure PN	Rohr A.D. Tube O.D. D1	Gewinde Thread G	Ca. Maße Approx. Dimensions								Bestellzeichen Order-Code SC	Brutto-Preis Gross-Price Euro (€)
				L1	L2	L3	L5	i	SW1	SW2	SW3		
L	500	6	M 10 x 1	27	12,0	34,5	26,0	8	14	12	14	ET-DKOL-06-M 10x1-wd-SC	44,17
L	500	8	M 12 x 1,5	29	14,0	37,5	27,5	12	17	12	17	ET-DKOL-08-M 12x1,5-wd-SC	47,19
L	500	10	M 14 x 1,5	30	15,0	40,0	29,0	12	19	14	19	ET-DKOL-10-M 14x1,5-wd-SC	56,29
L	400	12	M 16 x 1,5	32	17,0	42,0	29,5	12	22	17	22	ET-DKOL-12-M 16x1,5-wd-SC	63,37
L	400	15	M 18 x 1,5	36	21,0	46,0	32,5	12	24	19	27	ET-DKOL-15-M 18x1,5-wd-SC	84,93
L	400	18	M 22 x 1,5	40	23,5	50,0	35,5	14	27	24	32	ET-DKOL-18-M 22x1,5-wd-SC	111,96
L	250	22	M 26 x 1,5	44	27,5	55,0	38,5	16	32	27	36	ET-DKOL-22-M 26x1,5-wd-SC	134,08
L	250	28	M 33 x 2	47	30,5	59,0	41,5	18	41	36	41	ET-DKOL-28-M 33x2-wd-SC	226,26
L	250	35	M 42 x 2	56	34,5	68,5	51,0	20	50	41	50	ET-DKOL-35-M 42x2-wd-SC	321,99
L	250	42	M 48 x 2	63	40,0	75,0	56,0	22	55	50	60	ET-DKOL-42-M 48x2-wd-SC	433,71

Reihe Series	Druck Pressure PN	Rohr A.D. Tube O.D. D1	Gewinde Thread G	Ca. Maße Approx. Dimensions								Bestellzeichen Order-Code SC	Brutto-Preis Gross-Price Euro (€)
				L1	L2	L3	L5	i	SW1	SW2	SW3		
S	800	6	M 12 x 1,5	31	16,0	40,0	27,0	12	17	12	17	ET-DKOS-06-M 12x1,5-wd-SC	49,27
S	800	8	M 14 x 1,5	32	17,0	42,5	27,5	12	19	14	19	ET-DKOS-08-M 14x1,5-wd-SC	53,72
S	800	10	M 16 x 1,5	34	17,5	45,0	30,0	12	22	17	22	ET-DKOS-10-M 16x1,5-wd-SC	64,96
S	630	12	M 18 x 1,5	38	21,5	48,0	31,0	12	24	17	24	ET-DKOS-12-M 18x1,5-wd-SC	70,68
S	630	14	M 20 x 1,5	40	22,0	54,0	35,0	14	27	19	27	ET-DKOS-14-M 20x1,5-wd-SC	90,50
S	630	16	M 22 x 1,5	43	24,5	55,0	36,5	14	27	24	30	ET-DKOS-16-M 22x1,5-wd-SC	112,51
S	420	20	M 27 x 2	48	26,5	65,0	44,5	16	32	27	36	ET-DKOS-20-M 27x2-wd-SC	145,90
S	420	25	M 33 x 2	54	30,0	73,0	50,0	18	41	36	46	ET-DKOS-25-M 33x2-wd-SC	230,77
S	420	30	M 42 x 2	62	35,5	78,5	55,0	20	50	41	50	ET-DKOS-30-M 42x2-wd-SC	297,03
S	420	38	M 48 x 2	72	41,0	89,0	63,0	22	55	50	60	ET-DKOS-38-M 48x2-wd-SC	440,59



Einstellbare T-Verschraubungen mit Dichtkegel und O-Ring Viton
Rohrseitig Schneidringanschluss
Einschraubgewinde: Metrisches Feingewinde - Zylindrisch
wd = Abdichtung durch Profildichtung - Viton

*With Taper and O-ring - Viton
Cutting Ring Connection at the Tube Connection side
Thread: Metric - Parallel
wd = Sealing by an Elastomer Profiled Ring - Viton*

Reihe Series	Druck Pressure PN	Rohr A.D. Tube O.D. D1	Gewinde Thread G	Ca. Maße Approx. Dimensions						Bestellzeichen Order-Code OMD	Brutto-Preis Gross-Price Euro (€)
L	500	6	M 10 x 1							ET-DKOL-06-M 10x1-wd-OMD	38,91
L	500	8	M 12 x 1,5							ET-DKOL-08-M 12x1,5-wd-OMD	40,71
L	500	10	M 14 x 1,5							ET-DKOL-10-M 14x1,5-wd-OMD	48,69
L	400	12	M 16 x 1,5							ET-DKOL-12-M 16x1,5-wd-OMD	54,47
L	400	15	M 18 x 1,5							ET-DKOL-15-M 18x1,5-wd-OMD	72,49
L	400	18	M 22 x 1,5							ET-DKOL-18-M 22x1,5-wd-OMD	91,44
L	250	22	M 26 x 1,5							ET-DKOL-22-M 26x1,5-wd-OMD	109,94
L	250	28	M 33 x 2							ET-DKOL-28-M 33x2-wd-OMD	192,56
L	250	35	M 42 x 2							ET-DKOL-35-M 42x2-wd-OMD	272,33
L	250	42	M 48 x 2							ET-DKOL-42-M 48x2-wd-OMD	370,21

Reihe Series	Druck Pressure PN	Rohr A.D. Tube O.D. D1	Gewinde Thread G	Ca. Maße Approx. Dimensions						Bestellzeichen Order-Code OMD	Brutto-Preis Gross-Price Euro (€)
S	800	6	M 12 x 1,5							ET-DKOS-06-M 12x1,5-wd-OMD	42,81
S	800	8	M 14 x 1,5							ET-DKOS-08-M 14x1,5-wd-OMD	46,44
S	800	10	M 16 x 1,5							ET-DKOS-10-M 16x1,5-wd-OMD	55,96
S	630	12	M 18 x 1,5							ET-DKOS-12-M 18x1,5-wd-OMD	60,10
S	630	14	M 20 x 1,5							ET-DKOS-14-M 20x1,5-wd-OMD	76,38
S	630	16	M 22 x 1,5							ET-DKOS-16-M 22x1,5-wd-OMD	92,97
S	420	20	M 27 x 2							ET-DKOS-20-M 27x2-wd-OMD	120,98
S	420	25	M 33 x 2							ET-DKOS-25-M 33x2-wd-OMD	187,53
S	420	30	M 42 x 2							ET-DKOS-30-M 42x2-wd-OMD	241,83
S	420	38	M 48 x 2							ET-DKOS-38-M 48x2-wd-OMD	366,03

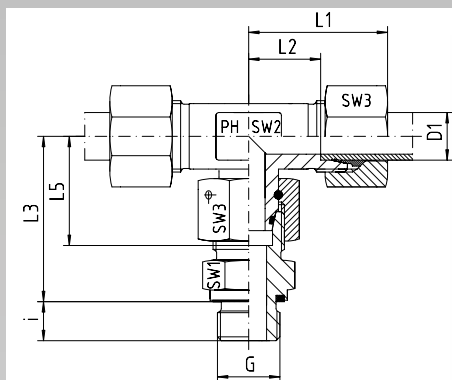

Einstellbare T-Verschraubungen mit Dichtkegel und O-Ring Viton
Rohrseitig Schneidringanschluss
Einschraubgewinde: Whitworth-Rohrgewinde - Zylindrisch
wd = Abdichtung durch Profildichtung - Viton

With Taper and O-ring - Viton
Cutting Ring Connection at the Tube Connection side
Thread: BSP - Parallel
wd = Sealing by an Elastomer Profiled Ring - Viton

Reihe Series	Druck Pressure PN	Rohr A.D. Tube O.D. D1	Gewinde Thread G	Ca. Maße Approx. Dimensions								Bestellzeichen Order-Code Standard	Brutto-Preis Gross-Price Euro (€)
				L1	L2	L3	L5	i	SW1	SW2	SW3		
L	500	6	G 1/8"	27	12,0	34,5	26,0	8	14	12	14	ET-DKOL-06-G 1/8"-wd	43,53
L	500	8	G 1/4"	29	14,0	37,5	27,5	12	17	12	17	ET-DKOL-08-G 1/4"-wd	45,90
L	500	10	G 1/4"	30	15,0	40,0	29,0	12	19	14	19	ET-DKOL-10-G 1/4"-wd	55,60
L	400	12	G 3/8"	32	17,0	42,0	29,5	12	22	17	22	ET-DKOL-12-G 3/8"-wd	61,50
L	400	15	G 1/2"	36	21,0	46,5	32,5	14	27	19	27	ET-DKOL-15-G 1/2"-wd	83,36
L	400	18	G 1/2"	40	23,5	50,0	35,5	14	27	24	32	ET-DKOL-18-G 1/2"-wd	107,35
L	250	22	G 3/4"	44	27,5	65,0	38,5	16	32	27	36	ET-DKOL-22-G 3/4"-wd	128,21
L	250	28	G 1"	47	30,5	69,0	41,5	18	41	36	41	ET-DKOL-28-G 1"-wd	221,78
L	250	35	G 1 1/4"	56	34,5	68,5	51,0	20	50	41	50	ET-DKOL-35-G 1 1/4"-wd	315,32
L	250	42	G 1 1/2"	63	40,0	75,0	56,0	22	55	50	60	ET-DKOL-42-G 1 1/2"-wd	425,07

Reihe Series	Druck Pressure PN	Rohr A.D. Tube O.D. D1	Gewinde Thread G	Ca. Maße Approx. Dimensions								Bestellzeichen Order-Code Standard	Brutto-Preis Gross-Price Euro (€)
				L1	L2	L3	L5	i	SW1	SW2	SW3		
S	800	6	G 1/4"	31	16,0	40,0	27,0	12	19	12	17	ET-DKOS-06-G 1/4"-wd	47,50
S	800	8	G 1/4"	32	17,0	42,5	27,5	12	19	14	19	ET-DKOS-08-G 1/4"-wd	50,11
S	800	10	G 3/8"	34	17,5	45,0	30,0	12	22	17	22	ET-DKOS-10-G 3/8"-wd	62,48
S	630	12	G 3/8"	38	21,5	48,0	31,0	12	22	17	24	ET-DKOS-12-G 3/8"-wd	67,75
S	630	14	G 1/2"	40	22,0	54,0	35,0	14	27	19	27	ET-DKOS-14-G 1/2"-wd	87,36
S	630	16	G 1/2"	43	24,5	55,0	36,5	14	27	24	30	ET-DKOS-16-G 1/2"-wd	110,93
S	420	20	G 3/4"	48	26,5	65,0	44,5	16	32	27	36	ET-DKOS-20-G 3/4"-wd	141,17
S	420	25	G 1"	54	30,0	73,0	50,0	18	41	36	46	ET-DKOS-25-G 1"-wd	225,28
S	420	30	G 1 1/4"	62	35,5	78,5	55,0	20	50	41	50	ET-DKOS-30-G 1 1/4"-wd	288,71
S	420	38	G 1 1/2"	72	41,0	89,0	63,0	22	55	50	60	ET-DKOS-38-G 1 1/2"-wd	429,70

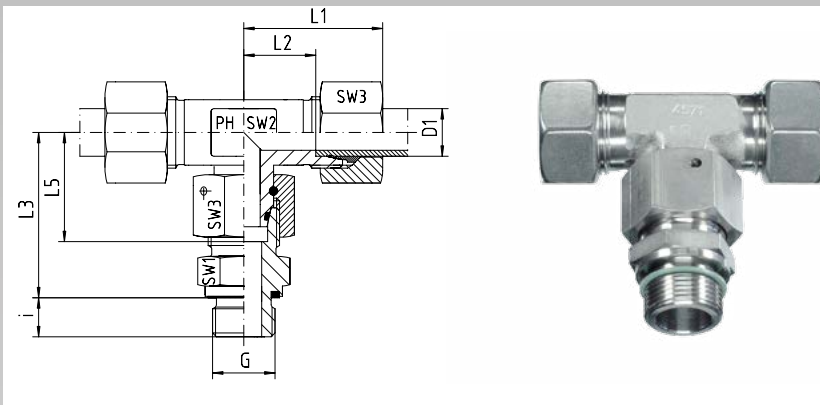

Einstellbare T-Verschraubungen mit Dichtkegel und O-Ring Viton
Rohrseitig Schneidringanschluss
Einschraubgewinde: Whitworth-Rohrgewinde - Zylindrisch
wd = Abdichtung durch Profildichtung - Viton

With Taper and O-ring - Viton
Cutting Ring Connection at the Tube Connection side
Thread: BSP - Parallel
wd = Sealing by an Elastomer Profiled Ring - Viton

Reihe Series	Druck Pressure PN	Rohr A.D. Tube O.D. D1	Gewinde Thread G	Ca. Maße Approx. Dimensions								Bestellzeichen Order-Code SC	Brutto-Preis Gross-Price Euro (€)
				L1	L2	L3	L5	i	SW1	SW2	SW3		
L	500	6	G 1/8"	27	12,0	34,5	26,0	8	14	12	14	ET-DKOL-06-G 1/8"-wd-SC	44,17
L	500	8	G 1/4"	29	14,0	37,5	27,5	12	17	12	17	ET-DKOL-08-G 1/4"-wd-SC	46,78
L	500	10	G 1/4"	30	15,0	40,0	29,0	12	19	14	19	ET-DKOL-10-G 1/4"-wd-SC	56,48
L	400	12	G 3/8"	32	17,0	42,0	29,5	12	22	17	22	ET-DKOL-12-G 3/8"-wd-SC	62,62
L	400	15	G 1/2"	36	21,0	46,5	32,5	14	27	19	27	ET-DKOL-15-G 1/2"-wd-SC	85,52
L	400	18	G 1/2"	40	23,5	50,0	35,5	14	27	24	32	ET-DKOL-18-G 1/2"-wd-SC	110,63
L	250	22	G 3/4"	44	27,5	65,0	38,5	16	32	27	36	ET-DKOL-22-G 3/4"-wd-SC	131,73
L	250	28	G 1"	47	30,5	69,0	41,5	18	41	36	41	ET-DKOL-28-G 1"-wd-SC	225,78
L	250	35	G 1 1/4"	56	34,5	68,5	51,0	20	50	41	50	ET-DKOL-35-G 1 1/4"-wd-SC	322,76
L	250	42	G 1 1/2"	63	40,0	75,0	56,0	22	55	50	60	ET-DKOL-42-G 1 1/2"-wd-SC	433,71

Reihe Series	Druck Pressure PN	Rohr A.D. Tube O.D. D1	Gewinde Thread G	Ca. Maße Approx. Dimensions								Bestellzeichen Order-Code SC	Brutto-Preis Gross-Price Euro (€)
				L1	L2	L3	L5	i	SW1	SW2	SW3		
S	800	6	G 1/4"	31	16,0	40,0	27,0	12	19	12	17	ET-DKOS-06-G 1/4"-wd-SC	48,38
S	800	8	G 1/4"	32	17,0	42,5	27,5	12	19	14	19	ET-DKOS-08-G 1/4"-wd-SC	50,99
S	800	10	G 3/8"	34	17,5	45,0	30,0	12	22	17	22	ET-DKOS-10-G 3/8"-wd-SC	63,60
S	630	12	G 3/8"	38	21,5	48,0	31,0	12	22	17	24	ET-DKOS-12-G 3/8"-wd-SC	69,43
S	630	14	G 1/2"	40	22,0	54,0	35,0	14	27	19	27	ET-DKOS-14-G 1/2"-wd-SC	90,48
S	630	16	G 1/2"	43	24,5	55,0	36,5	14	27	24	30	ET-DKOS-16-G 1/2"-wd-SC	114,05
S	420	20	G 3/4"	48	26,5	65,0	44,5	16	32	27	36	ET-DKOS-20-G 3/4"-wd-SC	144,93
S	420	25	G 1"	54	30,0	73,0	50,0	18	41	36	46	ET-DKOS-25-G 1"-wd-SC	231,28
S	420	30	G 1 1/4"	62	35,5	78,5	55,0	20	50	41	50	ET-DKOS-30-G 1 1/4"-wd-SC	297,03
S	420	38	G 1 1/2"	72	41,0	89,0	63,0	22	55	50	60	ET-DKOS-38-G 1 1/2"-wd-SC	440,98



Einstellbare T-Verschraubungen mit Dichtkegel und O-Ring Viton
Rohrseitig Schneidringanschluss
Einschraubgewinde: Whitworth-Rohrgewinde - Zylindrisch
wd = Abdichtung durch Profildichtung - Viton

*With Taper and O-ring - Viton
Cutting Ring Connection at the Tube Connection side
Thread: BSP - Parallel
wd = Sealing by an Elastomer Profiled Ring - Viton*

Reihe Series	Druck Pressure PN	Rohr A.D. Tube O.D. D1	Gewinde Thread G	Ca. Maße Approx. Dimensions						Bestellzeichen Order-Code OMD	Brutto-Preis Gross-Price Euro (€)
L	500	6	G 1/8"							ET-DKOL-06-G 1/8"-wd-OMD	38,91
L	500	8	G 1/4"							ET-DKOL-08-G 1/4"-wd-OMD	40,30
L	500	10	G 1/4"							ET-DKOL-10-G 1/4"-wd-OMD	48,88
L	400	12	G 3/8"							ET-DKOL-12-G 3/8"-wd-OMD	53,72
L	400	15	G 1/2"							ET-DKOL-15-G 1/2"-wd-OMD	73,08
L	400	18	G 1/2"							ET-DKOL-18-G 1/2"-wd-OMD	90,11
L	250	22	G 3/4"							ET-DKOL-22-G 3/4"-wd-OMD	107,59
L	250	28	G 1"							ET-DKOL-28-G 1"-wd-OMD	192,08
L	250	35	G 1 1/4"							ET-DKOL-35-G 1 1/4"-wd-OMD	273,10
L	250	42	G 1 1/2"							ET-DKOL-42-G 1 1/2"-wd-OMD	370,21

Reihe Series	Druck Pressure PN	Rohr A.D. Tube O.D. D1	Gewinde Thread G	Ca. Maße Approx. Dimensions						Bestellzeichen Order-Code OMD	Brutto-Preis Gross-Price Euro (€)
S	800	6	G 1/4"							ET-DKOS-06-G 1/4"-wd-OMD	41,92
S	800	8	G 1/4"							ET-DKOS-08-G 1/4"-wd-OMD	43,71
S	800	10	G 3/8"							ET-DKOS-10-G 3/8"-wd-OMD	54,60
S	630	12	G 3/8"							ET-DKOS-12-G 3/8"-wd-OMD	58,85
S	630	14	G 1/2"							ET-DKOS-14-G 1/2"-wd-OMD	76,36
S	630	16	G 1/2"							ET-DKOS-16-G 1/2"-wd-OMD	94,51
S	420	20	G 3/4"							ET-DKOS-20-G 3/4"-wd-OMD	120,01
S	420	25	G 1"							ET-DKOS-25-G 1"-wd-OMD	188,04
S	420	30	G 1 1/4"							ET-DKOS-30-G 1 1/4"-wd-OMD	241,83
S	420	38	G 1 1/2"							ET-DKOS-38-G 1 1/2"-wd-OMD	366,42

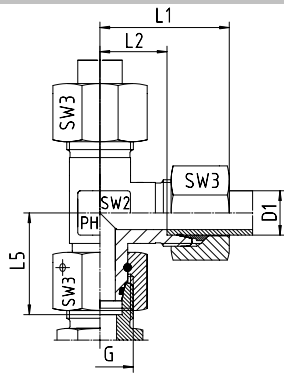

Einstellbare L-Verschraubungen mit Dichtkegel und O-Ring Viton
Rohrseitig Schneidringanschluss

*With Taper and O-ring - Viton
Cutting Ring Connection at the Tube Connection side*

Reihe Series	Druck Pressure PN	Rohr A.D. Tube O.D. D1	Gewinde Thread G	Ca. Maße Approx. Dimensions					Bestellzeichen Order-Code Standard	Brutto-Preis Gross-Price Euro (€)
				L1	L2	L5	SW2	SW3		
L	500	6	M 12 x 1,5	27	12,0	26,0	12	14	EL-DKOL-06	37,91
L	500	8	M 14 x 1,5	29	14,0	27,5	12	17	EL-DKOL-08	39,19
L	500	10	M 16 x 1,5	30	15,0	29,0	14	19	EL-DKOL-10	49,52
L	400	12	M 18 x 1,5	32	17,0	29,5	17	22	EL-DKOL-12	53,15
L	400	15	M 22 x 1,5	36	21,0	32,5	19	27	EL-DKOL-15	71,58
L	400	18	M 26 x 1,5	40	23,5	35,5	24	32	EL-DKOL-18	94,59
L	250	22	M 30 x 2	44	27,5	38,5	27	36	EL-DKOL-22	117,60
L	250	28	M 36 x 2	47	30,5	41,5	36	41	EL-DKOL-28	191,74
L	250	35	M 45 x 2	56	34,5	51,0	41	50	EL-DKOL-35	294,00
L	250	42	M 52 x 2	63	40,0	56,0	50	60	EL-DKOL-42	406,48

Reihe Series	Druck Pressure PN	Rohr A.D. Tube O.D. D1	Gewinde Thread G	Ca. Maße Approx. Dimensions					Bestellzeichen Order-Code Standard	Brutto-Preis Gross-Price Euro (€)
				L1	L2	L5	SW2	SW3		
S	800	6	M 14 x 1,5	31	16,0	27,0	12	17	EL-DKOS-06	39,45
S	800	8	M 16 x 1,5	32	17,0	27,5	14	19	EL-DKOS-08	42,77
S	800	10	M 18 x 1,5	34	17,5	30,0	17	22	EL-DKOS-10	53,38
S	630	12	M 20 x 1,5	38	21,5	31,0	17	24	EL-DKOS-12	58,80
S	630	14	M 22 x 1,5	40	22,0	35,0	19	27	EL-DKOS-14	74,14
S	630	16	M 24 x 1,5	43	24,5	36,5	24	30	EL-DKOS-16	94,59
S	420	20	M 30 x 2	48	26,5	44,5	27	36	EL-DKOS-20	120,16
S	420	25	M 36 x 2	54	30,0	50,0	36	46	EL-DKOS-25	202,47
S	420	30	M 42 x 2	62	35,5	55,0	41	50	EL-DKOS-30	301,67
S	420	38	M 52 x 2	72	41,0	63,0	50	60	EL-DKOS-38	416,71

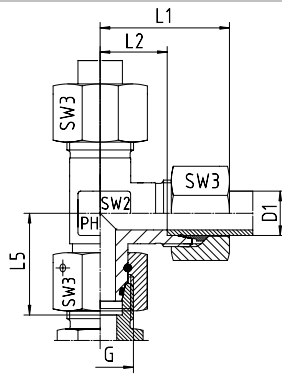

Einstellbare L-Verschraubungen mit Dichtkegel und O-Ring Viton
Rohrseitig Schneidringanschluss

*With Taper and O-ring - Viton
Cutting Ring Connection at the Tube Connection side*

Reihe Series	Druck Pressure PN	Rohr A.D. Tube O.D. D1	Gewinde Thread G	Ca. Maße Approx. Dimensions					Bestellzeichen Order-Code SC	Brutto-Preis Gross-Price Euro (€)
				L1	L2	L5	SW2	SW3		
L	500	6	M 12 x 1,5	27	12,0	26,0	12	14	EL-DKOL-06-SC	38,55
L	500	8	M 14 x 1,5	29	14,0	27,5	12	17	EL-DKOL-08-SC	40,07
L	500	10	M 16 x 1,5	30	15,0	29,0	14	19	EL-DKOL-10-SC	50,40
L	400	12	M 18 x 1,5	32	17,0	29,5	17	22	EL-DKOL-12-SC	54,27
L	400	15	M 22 x 1,5	36	21,0	32,5	19	27	EL-DKOL-15-SC	73,74
L	400	18	M 26 x 1,5	40	23,5	35,5	24	32	EL-DKOL-18-SC	97,87
L	250	22	M 30 x 2	44	27,5	38,5	27	36	EL-DKOL-22-SC	121,12
L	250	28	M 36 x 2	47	30,5	41,5	36	41	EL-DKOL-28-SC	195,74
L	250	35	M 45 x 2	56	34,5	51,0	41	50	EL-DKOL-35-SC	301,44
L	250	42	M 52 x 2	63	40,0	56,0	50	60	EL-DKOL-42-SC	415,12

Reihe Series	Druck Pressure PN	Rohr A.D. Tube O.D. D1	Gewinde Thread G	Ca. Maße Approx. Dimensions					Bestellzeichen Order-Code SC	Brutto-Preis Gross-Price Euro (€)
				L1	L2	L5	SW2	SW3		
S	800	6	M 14 x 1,5	31	16,0	27,0	12	17	EL-DKOS-06-SC	40,33
S	800	8	M 16 x 1,5	32	17,0	27,5	14	19	EL-DKOS-08-SC	43,65
S	800	10	M 18 x 1,5	34	17,5	30,0	17	22	EL-DKOS-10-SC	54,50
S	630	12	M 20 x 1,5	38	21,5	31,0	17	24	EL-DKOS-12-SC	60,48
S	630	14	M 22 x 1,5	40	22,0	35,0	19	27	EL-DKOS-14-SC	77,26
S	630	16	M 24 x 1,5	43	24,5	36,5	24	30	EL-DKOS-16-SC	97,71
S	420	20	M 30 x 2	48	26,5	44,5	27	36	EL-DKOS-20-SC	123,92
S	420	25	M 36 x 2	54	30,0	50,0	36	46	EL-DKOS-25-SC	208,47
S	420	30	M 42 x 2	62	35,5	55,0	41	50	EL-DKOS-30-SC	309,99
S	420	38	M 52 x 2	72	41,0	63,0	50	60	EL-DKOS-38-SC	427,99



Einstellbare L-Verschraubungen mit Dichtkegel und O-Ring Viton
Rohrseitig Schneidringanschluss

*With Taper and O-ring - Viton
Cutting Ring Connection at the Tube Connection side*

Reihe Series	Druck Pressure PN	Rohr A.D. Tube O.D. D1	Gewinde Thread G	Ca. Maße Approx. Dimensions				Bestellzeichen Order-Code OMD	Brutto-Preis Gross-Price Euro (€)
L	500	6	M 12 x 1,5					EL-DKOL-06-OMD	33,29
L	500	8	M 14 x 1,5					EL-DKOL-08-OMD	33,59
L	500	10	M 16 x 1,5					EL-DKOL-10-OMD	42,80
L	400	12	M 18 x 1,5					EL-DKOL-12-OMD	45,37
L	400	15	M 22 x 1,5					EL-DKOL-15-OMD	61,30
L	400	18	M 26 x 1,5					EL-DKOL-18-OMD	77,35
L	250	22	M 30 x 2					EL-DKOL-22-OMD	96,98
L	250	28	M 36 x 2					EL-DKOL-28-OMD	162,04
L	250	35	M 45 x 2					EL-DKOL-35-OMD	251,78
L	250	42	M 52 x 2					EL-DKOL-42-OMD	351,62

Reihe Series	Druck Pressure PN	Rohr A.D. Tube O.D. D1	Gewinde Thread G	Ca. Maße Approx. Dimensions				Bestellzeichen Order-Code OMD	Brutto-Preis Gross-Price Euro (€)
S	800	6	M 14 x 1,5					EL-DKOS-06-OMD	33,87
S	800	8	M 16 x 1,5					EL-DKOS-08-OMD	36,37
S	800	10	M 18 x 1,5					EL-DKOS-10-OMD	45,50
S	630	12	M 20 x 1,5					EL-DKOS-12-OMD	49,90
S	630	14	M 22 x 1,5					EL-DKOS-14-OMD	63,14
S	630	16	M 24 x 1,5					EL-DKOS-16-OMD	78,17
S	420	20	M 30 x 2					EL-DKOS-20-OMD	99,00
S	420	25	M 36 x 2					EL-DKOS-25-OMD	165,23
S	420	30	M 42 x 2					EL-DKOS-30-OMD	254,79
S	420	38	M 52 x 2					EL-DKOS-38-OMD	353,43

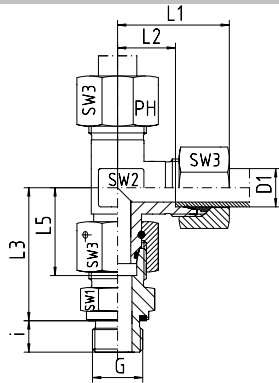

Einstellbare L-Verschraubungen mit Dichtkegel und O-Ring Viton
Rohrseitig Schneidringanschluss
Einschraubgewinde: Metrisches Feingewinde - Zylindrisch
wd = Abdichtung durch Profildichtung - Viton

With Taper and O-ring - Viton
Cutting Ring Connection at the Tube Connection side
Thread : Metric - Parallel
wd = Sealing by an Elastomer Profiled Ring - Viton

Reihe Series	Druck Pressure PN	Rohr A.D. Tube O.D. D1	Gewinde Thread G	Ca. Maße Approx. Dimensions								Bestellzeichen Order-Code Standard	Brutto-Preis Gross-Price Euro (€)
				L1	L2	L3	L5	i	SW1	SW2	SW3		
L	500	6	M 10 x 1	27	12,0	34,5	26,0	8	14	12	14	EL-DKOL-06-M 10x1-wd	43,53
L	500	8	M 12 x 1,5	29	14,0	37,5	27,5	12	17	12	17	EL-DKOL-08-M 12x1,5-wd	46,31
L	500	10	M 14 x 1,5	30	15,0	40,0	29,0	12	19	14	19	EL-DKOL-10-M 14x1,5-wd	56,53
L	400	12	M 16 x 1,5	32	17,0	42,0	29,5	12	22	17	22	EL-DKOL-12-M 16x1,5-wd	62,25
L	400	15	M 18 x 1,5	36	21,0	46,0	32,5	12	24	19	27	EL-DKOL-15-M 18x1,5-wd	82,77
L	400	18	M 22 x 1,5	40	23,5	50,0	35,5	14	27	24	32	EL-DKOL-18-M 22x1,5-wd	108,68
L	250	22	M 26 x 1,5	44	27,5	55,0	38,5	16	32	27	36	EL-DKOL-22-M 26x1,5-wd	138,23
L	250	28	M 33 x 2	47	30,5	59,0	41,5	18	41	36	41	EL-DKOL-28-M 33x3-wd	222,26
L	250	35	M 42 x 2	56	34,5	68,5	51,0	20	50	41	50	EL-DKOL-35-M 42x2-wd	327,33
L	250	42	M 48 x 2	63	40,0	75,0	56,0	22	55	50	60	EL-DKOL-42-M 48x2-wd	455,75

Reihe Series	Druck Pressure PN	Rohr A.D. Tube O.D. D1	Gewinde Thread G	Ca. Maße Approx. Dimensions								Bestellzeichen Order-Code Standard	Brutto-Preis Gross-Price Euro (€)
				L1	L2	L3	L5	i	SW1	SW2	SW3		
S	800	6	M 12 x 1,5	31	16,0	40,0	27,0	12	17	12	17	EL-DKOS-06-M 12x1,5-wd	48,39
S	800	8	M 14 x 1,5	32	17,0	42,5	27,5	12	19	14	19	EL-DKOS-08-M 14x1,5-wd	52,84
S	800	10	M 16 x 1,5	34	17,5	45,0	30,0	12	22	17	22	EL-DKOS-10-M 16x1,5-wd	63,84
S	630	12	M 18 x 1,5	38	21,5	48,0	31,0	12	24	17	24	EL-DKOS-12-M 18x1,5-wd	69,51
S	630	14	M 20 x 1,5	40	22,0	54,0	35,0	14	27	19	27	EL-DKOS-14-M 20x1,5-wd	87,38
S	630	16	M 22 x 1,5	43	24,5	55,0	36,5	14	27	24	30	EL-DKOS-16-M 22x1,5-wd	109,39
S	420	20	M 27 x 2	48	26,5	65,0	44,5	16	32	27	36	EL-DKOS-20-M 27x2-wd	142,14
S	420	25	M 33 x 2	54	30,0	73,0	50,0	18	41	36	46	EL-DKOS-25-M 33x2-wd	234,99
S	420	30	M 42 x 2	62	35,5	78,5	55,0	20	50	41	50	EL-DKOS-30-M 42x2-wd	339,84
S	420	38	M 48 x 2	72	41,0	89,0	63,0	22	55	50	60	EL-DKOS-38-M 48x2-wd	462,55

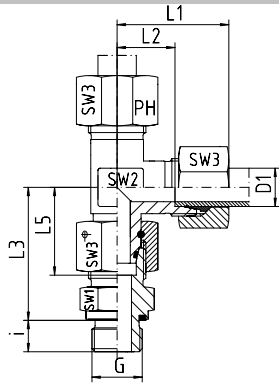

Einstellbare L-Verschraubungen mit Dichtkegel und O-Ring Viton
Rohrseitig Schneidringanschluss
Einschraubgewinde: Metrisches Feingewinde - Zylindrisch
wd = Abdichtung durch Profildichtung - Viton

With Taper and O-ring - Viton
Cutting Ring Connection at the Tube Connection side
Thread : Metric - Parallel
wd = Sealing by an Elastomer Profiled Ring - Viton

Reihe Series	Druck Pressure PN	Rohr A.D. Tube O.D. D1	Gewinde Thread G	Ca. Maße Approx. Dimensions								Bestellzeichen Order-Code SC	Brutto-Preis Gross-Price Euro (€)
				L1	L2	L3	L5	i	SW1	SW2	SW3		
L	500	6	M 10 x 1	27	12,0	34,5	26,0	8	14	12	14	EL-DKOL-06-M 10x1-wd-SC	44,17
L	500	8	M 12 x 1,5	29	14,0	37,5	27,5	12	17	12	17	EL-DKOL-08-M 12x1,5-wd-SC	47,19
L	500	10	M 14 x 1,5	30	15,0	40,0	29,0	12	19	14	19	EL-DKOL-10-M 14x1,5-wd-SC	57,41
L	400	12	M 16 x 1,5	32	17,0	42,0	29,5	12	22	17	22	EL-DKOL-12-M 16x1,5-wd-SC	63,37
L	400	15	M 18 x 1,5	36	21,0	46,0	32,5	12	24	19	27	EL-DKOL-15-M 18x1,5-wd-SC	84,93
L	400	18	M 22 x 1,5	40	23,5	50,0	35,5	14	27	24	32	EL-DKOL-18-M 22x1,5-wd-SC	111,96
L	250	22	M 26 x 1,5	44	27,5	55,0	38,5	16	32	27	36	EL-DKOL-22-M 26x1,5-wd-SC	141,75
L	250	28	M 33 x 2	47	30,5	59,0	41,5	18	41	36	41	EL-DKOL-28-M 33x3-wd-SC	226,26
L	250	35	M 42 x 2	56	34,5	68,5	51,0	20	50	41	50	EL-DKOL-35-M 42x2-wd-SC	334,77
L	250	42	M 48 x 2	63	40,0	75,0	56,0	22	55	50	60	EL-DKOL-42-M 48x2-wd-SC	464,39

Reihe Series	Druck Pressure PN	Rohr A.D. Tube O.D. D1	Gewinde Thread G	Ca. Maße Approx. Dimensions								Bestellzeichen Order-Code SC	Brutto-Preis Gross-Price Euro (€)
				L1	L2	L3	L5	i	SW1	SW2	SW3		
S	800	6	M 12 x 1,5	31	16,0	40,0	27,0	12	17	12	17	EL-DKOS-06-M 12x1,5-wd-SC	49,27
S	800	8	M 14 x 1,5	32	17,0	42,5	27,5	12	19	14	19	EL-DKOS-08-M 14x1,5-wd-SC	53,72
S	800	10	M 16 x 1,5	34	17,5	45,0	30,0	12	22	17	22	EL-DKOS-10-M 16x1,5-wd-SC	64,96
S	630	12	M 18 x 1,5	38	21,5	48,0	31,0	12	24	17	24	EL-DKOS-12-M 18x1,5-wd-SC	71,19
S	630	14	M 20 x 1,5	40	22,0	54,0	35,0	14	27	19	27	EL-DKOS-14-M 20x1,5-wd-SC	90,50
S	630	16	M 22 x 1,5	43	24,5	55,0	36,5	14	27	24	30	EL-DKOS-16-M 22x1,5-wd-SC	112,51
S	420	20	M 27 x 2	48	26,5	65,0	44,5	16	32	27	36	EL-DKOS-20-M 27x2-wd-SC	145,90
S	420	25	M 33 x 2	54	30,0	73,0	50,0	18	41	36	46	EL-DKOS-25-M 33x2-wd-SC	240,99
S	420	30	M 42 x 2	62	35,5	78,5	55,0	20	50	41	50	EL-DKOS-30-M 42x2-wd-SC	348,16
S	420	38	M 48 x 2	72	41,0	89,0	63,0	22	55	50	60	EL-DKOS-38-M 48x2-wd-SC	473,83



Einstellbare L-Verschraubungen mit Dichtkegel und O-Ring Viton

Rohrseitig Schneidringanschluss

Einschraubgewinde: Metrisches Feingewinde - Zylindrisch
wd = Abdichtung durch Profildichtung - Viton

With Taper and O-ring - Viton

Cutting Ring Connection at the Tube Connection side

Thread : Metric - Parallel

wd = Sealing by an Elastomer Profiled Ring - Viton

Reihe Series	Druck Pressure PN	Rohr A.D. Tube O.D. D1	Gewinde Thread G	Ca. Maße Approx. Dimensions						Bestellzeichen Order-Code OMD	Brutto-Preis Gross-Price Euro (€)
L	500	6	M 10 x 1							EL-DKOL-06-M 10x1-wd-OMD	38,91
L	500	8	M 12 x 1,5							EL-DKOL-08-M 12x1,5-wd-OMD	40,71
L	500	10	M 14 x 1,5							EL-DKOL-10-M 14x1,5-wd-OMD	49,81
L	400	12	M 16 x 1,5							EL-DKOL-12-M 16x1,5-wd-OMD	54,47
L	400	15	M 18 x 1,5							EL-DKOL-15-M 18x1,5-wd-OMD	72,49
L	400	18	M 22 x 1,5							EL-DKOL-18-M 22x1,5-wd-OMD	91,44
L	250	22	M 26 x 1,5							EL-DKOL-22-M 26x1,5-wd-OMD	117,61
L	250	28	M 33 x 2							EL-DKOL-28-M 33x2-wd-OMD	192,56
L	250	35	M 42 x 2							EL-DKOL-35-M 42x2-wd-OMD	285,11
L	250	42	M 48 x 2							EL-DKOL-42-M 48x2-wd-OMD	400,89

Reihe Series	Druck Pressure PN	Rohr A.D. Tube O.D. D1	Gewinde Thread G	Ca. Maße Approx. Dimensions						Bestellzeichen Order-Code OMD	Brutto-Preis Gross-Price Euro (€)
S	800	6	M 12 x 1,5							EL-DKOS-06-M 12x1,5-wd-OMD	42,81
S	800	8	M 14 x 1,5							EL-DKOS-08-M 14x1,5-wd-OMD	46,44
S	800	10	M 16 x 1,5							EL-DKOS-10-M 16x1,5-wd-OMD	55,96
S	630	12	M 18 x 1,5							EL-DKOS-12-M 18x1,5-wd-OMD	60,61
S	630	14	M 20 x 1,5							EL-DKOS-14-M 20x1,5-wd-OMD	76,38
S	630	16	M 22 x 1,5							EL-DKOS-16-M 22x1,5-wd-OMD	92,97
S	420	20	M 27 x 2							EL-DKOS-20-M 27x2-wd-OMD	120,98
S	420	25	M 33 x 2							EL-DKOS-25-M 33x2-wd-OMD	197,75
S	420	30	M 42 x 2							EL-DKOS-30-M 42x2-wd-OMD	292,96
S	420	38	M 48 x 2							EL-DKOS-38-M 48x2-wd-OMD	399,27

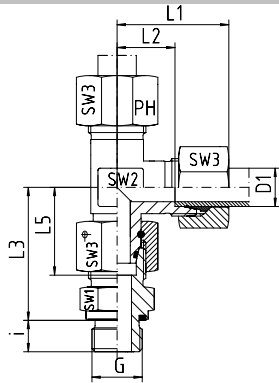

Einstellbare L-Verschraubungen mit Dichtkegel und O-Ring Viton
Rohrseitig Schneidringanschluss
Einschraubgewinde: Whitworth-Rohrgewinde - Zylindrisch
wd = Abdichtung durch Profildichtung - Viton

With Taper and O-ring - Viton
Cutting Ring Connection at the Tube Connection side
Thread : BSP - Parallel
wd = Sealing by an Elastomer Profiled Ring - Viton

Reihe Series	Druck Pressure PN	Rohr A.D. Tube O.D. D1	Gewinde Thread G	Ca. Maße Approx. Dimensions								Bestellzeichen Order-Code Standard	Brutto-Preis Gross-Price Euro (€)
				L1	L2	L3	L5	i	SW1	SW2	SW3		
L	500	6	G 1/8"	27	12,0	34,5	26,0	8	14	12	14	EL-DKOL-06-G 1/8"-wd	43,53
L	500	8	G 1/4"	29	14,0	37,5	27,5	12	19	12	17	EL-DKOL-08-G 1/4"-wd	45,90
L	500	10	G 1/4"	30	15,0	40,0	29,0	12	19	14	19	EL-DKOL-10-G 1/4"-wd	56,59
L	400	12	G 3/8"	32	17,0	42,0	29,5	12	22	17	22	EL-DKOL-12-G 3/8"-wd	61,50
L	400	15	G 1/2"	36	21,0	46,5	32,5	14	27	19	27	EL-DKOL-15-G 1/2"-wd	83,36
L	400	18	G 1/2"	40	23,5	50,0	35,5	14	27	24	32	EL-DKOL-18-G 1/2"-wd	107,35
L	250	22	G 3/4"	44	27,5	55,0	38,5	16	32	27	36	EL-DKOL-22-G 3/4"-wd	135,88
L	250	28	G 1"	47	30,5	59,0	41,5	18	41	36	41	EL-DKOL-28-G 1"-wd	221,78
L	250	35	G 1 1/4"	56	34,5	68,5	51,0	20	50	41	50	EL-DKOL-35-G 1 1/4"-wd	328,10
L	250	42	G 1 1/2"	63	40,0	75,0	56,0	22	55	50	60	EL-DKOL-42-G 1 1/2"-wd	455,75

Reihe Series	Druck Pressure PN	Rohr A.D. Tube O.D. D1	Gewinde Thread G	Ca. Maße Approx. Dimensions								Bestellzeichen Order-Code Standard	Brutto-Preis Gross-Price Euro (€)
				L1	L2	L3	L5	i	SW1	SW2	SW3		
S	800	6	G 1/4"	31	16,0	40,0	27,0	12	19	12	17	EL-DKOS-06-G 1/4"-wd	47,50
S	800	8	G 1/4"	32	17,0	42,5	27,5	12	19	14	19	EL-DKOS-08-G 1/4"-wd	50,11
S	800	10	G 3/8"	34	17,5	45,0	30,0	12	22	17	22	EL-DKOS-10-G 3/8"-wd	62,43
S	630	12	G 3/8"	38	21,5	48,0	31,0	12	22	17	24	EL-DKOS-12-G 3/8"-wd	68,26
S	630	14	G 1/2"	40	22,0	54,0	35,0	14	27	19	27	EL-DKOS-14-G 1/2"-wd	87,36
S	630	16	G 1/2"	43	24,5	55,0	36,5	14	27	24	30	EL-DKOS-16-G 1/2"-wd	110,93
S	420	20	G 3/4"	48	26,5	65,0	44,5	16	32	27	36	EL-DKOS-20-G 3/4"-wd	141,17
S	420	25	G 1"	54	30,0	73,0	50,0	18	41	36	46	EL-DKOS-25-G 1"-wd	235,50
S	420	30	G 1 1/4"	62	35,5	78,5	55,0	20	50	41	50	EL-DKOS-30-G 1 1/4"-wd	339,84
S	420	38	G 1 1/2"	72	41,0	89,0	63,0	22	55	50	60	EL-DKOS-38-G 1 1/2"-wd	462,93

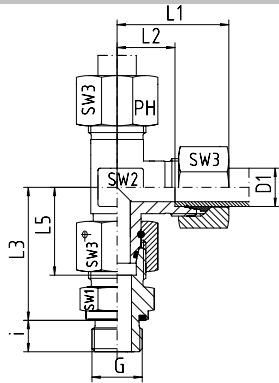

Einstellbare L-Verschraubungen mit Dichtkegel und O-Ring Viton
Rohrseitig Schneidringanschluss
Einschraubgewinde: Whitworth-Rohrgewinde - Zylindrisch
wd = Abdichtung durch Profildichtung - Viton

With Taper and O-ring - Viton
Cutting Ring Connection at the Tube Connection side
Thread : BSP - Parallel
wd = Sealing by an Elastomer Profiled Ring - Viton

Reihe Series	Druck Pressure PN	Rohr A.D. Tube O.D. D1	Gewinde Thread G	Ca. Maße Approx. Dimensions								Bestellzeichen Order-Code SC	Brutto-Preis Gross-Price Euro (€)
				L1	L2	L3	L5	i	SW1	SW2	SW3		
L	500	6	G 1/8"	27	12,0	34,5	26,0	8	14	12	14	EL-DKOL-06-G 1/8"-wd-SC	44,17
L	500	8	G 1/4"	29	14,0	37,5	27,5	12	19	12	17	EL-DKOL-08-G 1/4"-wd-SC	46,78
L	500	10	G 1/4"	30	15,0	40,0	29,0	12	19	14	19	EL-DKOL-10-G 1/4"-wd-SC	57,47
L	400	12	G 3/8"	32	17,0	42,0	29,5	12	22	17	22	EL-DKOL-12-G 3/8"-wd-SC	62,62
L	400	15	G 1/2"	36	21,0	46,5	32,5	14	27	19	27	EL-DKOL-15-G 1/2"-wd-SC	85,52
L	400	18	G 1/2"	40	23,5	50,0	35,5	14	27	24	32	EL-DKOL-18-G 1/2"-wd-SC	110,63
L	250	22	G 3/4"	44	27,5	55,0	38,5	16	32	27	36	EL-DKOL-22-G 3/4"-wd-SC	139,40
L	250	28	G 1"	47	30,5	59,0	41,5	18	41	36	41	EL-DKOL-28-G 1"-wd-SC	225,78
L	250	35	G 1 1/4"	56	34,5	68,5	51,0	20	50	41	50	EL-DKOL-35-G 1 1/4"-wd-SC	335,54
L	250	42	G 1 1/2"	63	40,0	75,0	56,0	22	55	50	60	EL-DKOL-42-G 1 1/2"-wd-SC	464,39

Reihe Series	Druck Pressure PN	Rohr A.D. Tube O.D. D1	Gewinde Thread G	Ca. Maße Approx. Dimensions								Bestellzeichen Order-Code SC	Brutto-Preis Gross-Price Euro (€)
				L1	L2	L3	L5	i	SW1	SW2	SW3		
S	800	6	G 1/4"	31	16,0	40,0	27,0	12	19	12	17	EL-DKOS-06-G 1/4"-wd-SC	48,38
S	800	8	G 1/4"	32	17,0	42,5	27,5	12	19	14	19	EL-DKOS-08-G 1/4"-wd-SC	50,99
S	800	10	G 3/8"	34	17,5	45,0	30,0	12	22	17	22	EL-DKOS-10-G 3/8"-wd-SC	63,55
S	630	12	G 3/8"	38	21,5	48,0	31,0	12	22	17	24	EL-DKOS-12-G 3/8"-wd-SC	69,94
S	630	14	G 1/2"	40	22,0	54,0	35,0	14	27	19	27	EL-DKOS-14-G 1/2"-wd-SC	90,48
S	630	16	G 1/2"	43	24,5	55,0	36,5	14	27	24	30	EL-DKOS-16-G 1/2"-wd-SC	114,05
S	420	20	G 3/4"	48	26,5	65,0	44,5	16	32	27	36	EL-DKOS-20-G 3/4"-wd-SC	144,93
S	420	25	G 1"	54	30,0	73,0	50,0	18	41	36	46	EL-DKOS-25-G 1"-wd-SC	241,50
S	420	30	G 1 1/4"	62	35,5	78,5	55,0	20	50	41	50	EL-DKOS-30-G 1 1/4"-wd-SC	348,16
S	420	38	G 1 1/2"	72	41,0	89,0	63,0	22	55	50	60	EL-DKOS-38-G 1 1/2"-wd-SC	474,21



Einstellbare L-Verschraubungen mit Dichtkegel und O-Ring Viton
Rohrseitig Schneidringanschluss
Einschraubgewinde: Whitworth-Rohrgewinde - Zylindrisch
wd = Abdichtung durch Profildichtung - Viton

*With Taper and O-ring - Viton
Cutting Ring Connection at the Tube Connection side
Thread : BSP - Parallel
wd = Sealing by an Elastomer Profiled Ring - Viton*

Reihe Series	Druck Pressure PN	Rohr A.D. Tube O.D. D1	Gewinde Thread G	Ca. Maße Approx. Dimensions						Bestellzeichen Order-Code OMD	Brutto-Preis Gross-Price Euro (€)
L	500	6	G 1/8"							EL-DKOL-06-G 1/8"-wd-OMD	38,91
L	500	8	G 1/4"							EL-DKOL-08-G 1/4"-wd-OMD	40,30
L	500	10	G 1/4"							EL-DKOL-10-G 1/4"-wd-OMD	49,87
L	400	12	G 3/8"							EL-DKOL-12-G 3/8"-wd-OMD	53,72
L	400	15	G 1/2"							EL-DKOL-15-G 1/2"-wd-OMD	73,08
L	400	18	G 1/2"							EL-DKOL-18-G 1/2"-wd-OMD	90,11
L	250	22	G 3/4"							EL-DKOL-22-G 3/4"-wd-OMD	115,26
L	250	28	G 1"							EL-DKOL-28-G 1"-wd-OMD	192,08
L	250	35	G 1 1/4"							EL-DKOL-35-G 1 1/4"-wd-OMD	285,88
L	250	42	G 1 1/2"							EL-DKOL-42-G 1 1/2"-wd-OMD	400,89

Reihe Series	Druck Pressure PN	Rohr A.D. Tube O.D. D1	Gewinde Thread G	Ca. Maße Approx. Dimensions						Bestellzeichen Order-Code OMD	Brutto-Preis Gross-Price Euro (€)
S	800	6	G 1/4"							EL-DKOS-06-G 1/4"-wd-OMD	41,92
S	800	8	G 1/4"							EL-DKOS-08-G 1/4"-wd-OMD	43,71
S	800	10	G 3/8"							EL-DKOS-10-G 3/8"-wd-OMD	54,55
S	630	12	G 3/8"							EL-DKOS-12-G 3/8"-wd-OMD	59,36
S	630	14	G 1/2"							EL-DKOS-14-G 1/2"-wd-OMD	76,36
S	630	16	G 1/2"							EL-DKOS-16-G 1/2"-wd-OMD	94,51
S	420	20	G 3/4"							EL-DKOS-20-G 3/4"-wd-OMD	120,01
S	420	25	G 1"							EL-DKOS-25-G 1"-wd-OMD	198,26
S	420	30	G 1 1/4"							EL-DKOS-30-G 1 1/4"-wd-OMD	292,96
S	420	38	G 1 1/2"							EL-DKOS-38-G 1 1/2"-wd-OMD	399,65

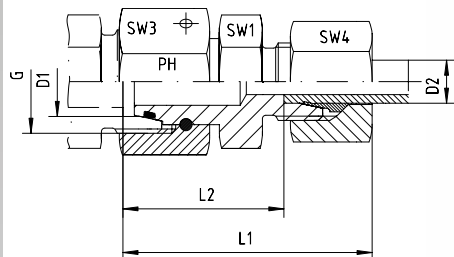

Mit Dichtkegel und O-Ring (DKO) - Viton
Passend in Bohrungsform W DIN 3861
Andere Abmessungen auf Anfrage!

With Taper and O-ring - Viton
For Type of Port End W DIN 3861
Other dimensions on request!

Reihe Series	Druck Pressure PN	Rohr A.D. Tube O.D.		Gewinde Thread G	Ca. Maße Approx. Dimensions					Bestellzeichen Order-Code Standard	Brutto-Preis Gross-Price Euro (€)
		D1	D2		L1	L2	SW1	SW3	SW4		
L	500	8	6	M 14 x 1,5	38	23,5	12	17	14	RED-DKOL-08/06	16,11
L	500	10	6	M 16 x 1,5	40	25,0	14	19	14	RED-DKOL-10/06	16,72
L	500	10	8	M 16 x 1,5	40	25,0	14	19	17	RED-DKOL-10/08	17,74
L	400	12	6	M 18 x 1,5	40	25,0	17	22	14	RED-DKOL-12/06	21,99
L	400	12	8	M 18 x 1,5	40	25,0	17	22	17	RED-DKOL-12/08	22,50
L	400	12	10	M 18 x 1,5	41	26,0	17	22	19	RED-DKOL-12/10	24,49
L	400	15	6	M 22 x 1,5	43	28,5	19	27	14	RED-DKOL-15/06	24,95
L	400	15	8	M 22 x 1,5	43	28,5	19	27	17	RED-DKOL-15/08	25,56
L	400	15	10	M 22 x 1,5	44	29,5	19	27	19	RED-DKOL-15/10	26,08
L	400	15	12	M 22 x 1,5	44	29,5	19	27	22	RED-DKOL-15/12	27,10
L	400	18	6	M 26 x 1,5	43	28,0	24	32	14	RED-DKOL-18/06	28,63
L	400	18	8	M 26 x 1,5	43	28,0	24	32	17	RED-DKOL-18/08	30,68
L	400	18	10	M 26 x 1,5	44	29,0	24	32	19	RED-DKOL-18/10	30,73
L	400	18	12	M 26 x 1,5	44	29,0	24	32	22	RED-DKOL-18/12	31,70
L	400	18	15	M 26 x 1,5	45	30,0	24	32	27	RED-DKOL-18/15	33,23
L	250	22	6	M 30 x 2	47	32,0	27	36	14	RED-DKOL-22/06	36,81
L	250	22	8	M 30 x 2	47	32,0	27	36	17	RED-DKOL-22/08	35,54
L	250	22	10	M 30 x 2	48	33,0	27	36	19	RED-DKOL-22/10	38,86
L	250	22	12	M 30 x 2	48	33,0	27	36	22	RED-DKOL-22/12	38,86
L	250	22	15	M 30 x 2	49	34,0	27	36	27	RED-DKOL-22/15	46,02
L	250	22	18	M 30 x 2	50	33,5	27	36	32	RED-DKOL-22/18	50,62
L	250	28	6	M 36 x 2	49	34,0	32	41	14	RED-DKOL-28/06	49,65
L	250	28	8	M 36 x 2	49	34,0	32	41	17	RED-DKOL-28/08	52,15
L	250	28	10	M 36 x 2	50	35,0	32	41	19	RED-DKOL-28/10	53,69
L	250	28	12	M 36 x 2	50	35,0	32	41	22	RED-DKOL-28/12	53,69
L	250	28	15	M 36 x 2	51	36,0	32	41	27	RED-DKOL-28/15	54,20
L	250	28	18	M 36 x 2	52	35,5	32	41	32	RED-DKOL-28/18	56,75
L	250	28	22	M 36 x 2	54	37,5	32	41	36	RED-DKOL-28/22	63,40
L	250	35	6	M 45 x 2	52	37,0	41	50	14	RED-DKOL-35/06	73,63
L	250	35	8	M 45 x 2	52	37,0	41	50	17	RED-DKOL-35/08	75,16
L	250	35	10	M 45 x 2	53	38,0	41	50	19	RED-DKOL-35/10	79,25
L	250	35	12	M 45 x 2	53	38,0	41	50	22	RED-DKOL-35/12	80,27
L	250	35	15	M 45 x 2	54	39,0	41	50	27	RED-DKOL-35/15	83,85
L	250	35	18	M 45 x 2	55	38,5	41	50	32	RED-DKOL-35/18	85,90
L	250	35	22	M 45 x 2	57	40,5	41	50	36	RED-DKOL-35/22	86,92
L	250	35	28	M 45 x 2	57	40,5	41	50	41	RED-DKOL-35/28	92,03
L	250	42	6	M 52 x 2	55	40,5	50	60	14	RED-DKOL-42/06	102,26
L	250	42	8	M 52 x 2	55	40,5	50	60	17	RED-DKOL-42/08	101,24
L	250	42	10	M 52 x 2	56	41,5	50	60	19	RED-DKOL-42/10	101,24
L	250	42	12	M 52 x 2	56	41,5	50	60	22	RED-DKOL-42/12	103,28
L	250	42	15	M 52 x 2	58	42,5	50	60	27	RED-DKOL-42/15	104,82
L	250	42	18	M 52 x 2	58	42,0	50	60	32	RED-DKOL-42/18	108,14
L	250	42	22	M 52 x 2	60	44,0	50	60	36	RED-DKOL-42/22	109,93
L	250	42	28	M 52 x 2	61	44,0	50	60	41	RED-DKOL-42/28	114,53
L	250	42	35	M 52 x 2	65	43,0	50	60	50	RED-DKOL-42/35	119,13

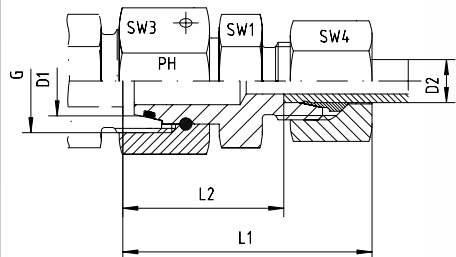

Mit Dichtkegel und O-Ring (DKO) - Viton
Passend in Bohrungsform W DIN 3861
Andere Abmessungen auf Anfrage!

With Taper and O-ring - Viton
For Type of Port End W DIN 3861
Other dimensions on request!

Reihe Series	Druck Pressure PN	Rohr A.D. Tube O.D.		Gewinde Thread G	Ca. Maße Approx. Dimensions					Bestellzeichen Order-Code SC	Brutto-Preis Gross-Price Euro (€)
		D1	D2		L1	L2	SW1	SW3	SW4		
L	500	8	6	M 14 x 1,5	38	23,5	12	17	14	RED-DKOL-08/06-SC	16,43
L	500	10	6	M 16 x 1,5	40	25,0	14	19	14	RED-DKOL-10/06-SC	17,04
L	500	10	8	M 16 x 1,5	40	25,0	14	19	17	RED-DKOL-10/08-SC	18,18
L	400	12	6	M 18 x 1,5	40	25,0	17	22	14	RED-DKOL-12/06-SC	22,31
L	400	12	8	M 18 x 1,5	40	25,0	17	22	17	RED-DKOL-12/08-SC	22,94
L	400	12	10	M 18 x 1,5	41	26,0	17	22	19	RED-DKOL-12/10-SC	24,93
L	400	15	6	M 22 x 1,5	43	28,5	19	27	14	RED-DKOL-15/06-SC	25,27
L	400	15	8	M 22 x 1,5	43	28,5	19	27	17	RED-DKOL-15/08-SC	26,00
L	400	15	10	M 22 x 1,5	44	29,5	19	27	19	RED-DKOL-15/10-SC	26,52
L	400	15	12	M 22 x 1,5	44	29,5	19	27	22	RED-DKOL-15/12-SC	27,66
L	400	18	6	M 26 x 1,5	43	28,0	24	32	14	RED-DKOL-18/06-SC	28,95
L	400	18	8	M 26 x 1,5	43	28,0	24	32	17	RED-DKOL-18/08-SC	31,12
L	400	18	10	M 26 x 1,5	44	29,0	24	32	19	RED-DKOL-18/10-SC	31,17
L	400	18	12	M 26 x 1,5	44	29,0	24	32	22	RED-DKOL-18/12-SC	32,26
L	400	18	15	M 26 x 1,5	45	30,0	24	32	27	RED-DKOL-18/15-SC	34,31
L	250	22	6	M 30 x 2	47	32,0	27	36	14	RED-DKOL-22/06-SC	37,13
L	250	22	8	M 30 x 2	47	32,0	27	36	17	RED-DKOL-22/08-SC	35,98
L	250	22	10	M 30 x 2	48	33,0	27	36	19	RED-DKOL-22/10-SC	39,30
L	250	22	12	M 30 x 2	48	33,0	27	36	22	RED-DKOL-22/12-SC	39,42
L	250	22	15	M 30 x 2	49	34,0	27	36	27	RED-DKOL-22/15-SC	47,10
L	250	22	18	M 30 x 2	50	33,5	27	36	32	RED-DKOL-22/18-SC	52,26
L	250	28	6	M 36 x 2	49	34,0	32	41	14	RED-DKOL-28/06-SC	49,97
L	250	28	8	M 36 x 2	49	34,0	32	41	17	RED-DKOL-28/08-SC	52,59
L	250	28	10	M 36 x 2	50	35,0	32	41	19	RED-DKOL-28/10-SC	54,13
L	250	28	12	M 36 x 2	50	35,0	32	41	22	RED-DKOL-28/12-SC	54,25
L	250	28	15	M 36 x 2	51	36,0	32	41	27	RED-DKOL-28/15-SC	55,28
L	250	28	18	M 36 x 2	52	35,5	32	41	32	RED-DKOL-28/18-SC	58,39
L	250	28	22	M 36 x 2	54	37,5	32	41	36	RED-DKOL-28/22-SC	65,16
L	250	35	6	M 45 x 2	52	37,0	41	50	14	RED-DKOL-35/06-SC	73,95
L	250	35	8	M 45 x 2	52	37,0	41	50	17	RED-DKOL-35/08-SC	75,60
L	250	35	10	M 45 x 2	53	38,0	41	50	19	RED-DKOL-35/10-SC	79,69
L	250	35	12	M 45 x 2	53	38,0	41	50	22	RED-DKOL-35/12-SC	80,83
L	250	35	15	M 45 x 2	54	39,0	41	50	27	RED-DKOL-35/15-SC	84,93
L	250	35	18	M 45 x 2	55	38,5	41	50	32	RED-DKOL-35/18-SC	87,54
L	250	35	22	M 45 x 2	57	40,5	41	50	36	RED-DKOL-35/22-SC	88,68
L	250	35	28	M 45 x 2	57	40,5	41	50	41	RED-DKOL-35/28-SC	94,03
L	250	42	6	M 52 x 2	55	40,5	50	60	14	RED-DKOL-42/06-SC	102,58
L	250	42	8	M 52 x 2	55	40,5	50	60	17	RED-DKOL-42/08-SC	101,68
L	250	42	10	M 52 x 2	56	41,5	50	60	19	RED-DKOL-42/10-SC	101,68
L	250	42	12	M 52 x 2	56	41,5	50	60	22	RED-DKOL-42/12-SC	103,84
L	250	42	15	M 52 x 2	58	42,5	50	60	27	RED-DKOL-42/15-SC	105,90
L	250	42	18	M 52 x 2	58	42,0	50	60	32	RED-DKOL-42/18-SC	109,78
L	250	42	22	M 52 x 2	60	44,0	50	60	36	RED-DKOL-42/22-SC	111,69
L	250	42	28	M 52 x 2	61	44,0	50	60	41	RED-DKOL-42/28-SC	116,53
L	250	42	35	M 52 x 2	65	43,0	50	60	50	RED-DKOL-42/35-SC	122,85



Mit Dichtkegel und O-Ring (DKO) - Viton
Passend in Bohrungsform W DIN 3861
Andere Abmessungen auf Anfrage!

*With Taper and O-ring - Viton
For Type of Port End W DIN 3861
Other dimensions on request!*

Reihe Series	Druck Pressure PN	Rohr A.D. Tube O.D.		Gewinde Thread G	Ca. Maße Approx. Dimensions				Bestellzeichen Order-Code OMD	Brutto-Preis Gross-Price Euro (€)
		D1	D2							
L	500	8	6	M 14 x 1,5					RED-DKOL-08/06-OMD	13,80
L	500	10	6	M 16 x 1,5					RED-DKOL-10/06-OMD	14,41
L	500	10	8	M 16 x 1,5					RED-DKOL-10/08-OMD	14,94
L	400	12	6	M 18 x 1,5					RED-DKOL-12/06-OMD	19,68
L	400	12	8	M 18 x 1,5					RED-DKOL-12/08-OMD	19,70
L	400	12	10	M 18 x 1,5					RED-DKOL-12/10-OMD	21,13
L	400	15	6	M 22 x 1,5					RED-DKOL-15/06-OMD	22,64
L	400	15	8	M 22 x 1,5					RED-DKOL-15/08-OMD	22,76
L	400	15	10	M 22 x 1,5					RED-DKOL-15/10-OMD	22,72
L	400	15	12	M 22 x 1,5					RED-DKOL-15/12-OMD	23,21
L	400	18	6	M 26 x 1,5					RED-DKOL-18/06-OMD	26,32
L	400	18	8	M 26 x 1,5					RED-DKOL-18/08-OMD	27,88
L	400	18	10	M 26 x 1,5					RED-DKOL-18/10-OMD	27,37
L	400	18	12	M 26 x 1,5					RED-DKOL-18/12-OMD	27,81
L	400	18	15	M 26 x 1,5					RED-DKOL-18/15-OMD	28,09
L	250	22	6	M 30 x 2					RED-DKOL-22/06-OMD	34,50
L	250	22	8	M 30 x 2					RED-DKOL-22/08-OMD	32,74
L	250	22	10	M 30 x 2					RED-DKOL-22/10-OMD	35,50
L	250	22	12	M 30 x 2					RED-DKOL-22/12-OMD	34,97
L	250	22	15	M 30 x 2					RED-DKOL-22/15-OMD	40,88
L	250	22	18	M 30 x 2					RED-DKOL-22/18-OMD	42,00
L	250	28	6	M 36 x 2					RED-DKOL-28/06-OMD	47,34
L	250	28	8	M 36 x 2					RED-DKOL-28/08-OMD	49,35
L	250	28	10	M 36 x 2					RED-DKOL-28/10-OMD	50,33
L	250	28	12	M 36 x 2					RED-DKOL-28/12-OMD	49,80
L	250	28	15	M 36 x 2					RED-DKOL-28/15-OMD	49,06
L	250	28	18	M 36 x 2					RED-DKOL-28/18-OMD	48,13
L	250	28	22	M 36 x 2					RED-DKOL-28/22-OMD	53,09
L	250	35	6	M 45 x 2					RED-DKOL-35/06-OMD	71,32
L	250	35	8	M 45 x 2					RED-DKOL-35/08-OMD	72,36
L	250	35	10	M 45 x 2					RED-DKOL-35/10-OMD	75,89
L	250	35	12	M 45 x 2					RED-DKOL-35/12-OMD	76,38
L	250	35	15	M 45 x 2					RED-DKOL-35/15-OMD	78,71
L	250	35	18	M 45 x 2					RED-DKOL-35/18-OMD	77,28
L	250	35	22	M 45 x 2					RED-DKOL-35/22-OMD	76,61
L	250	35	28	M 45 x 2					RED-DKOL-35/28-OMD	77,18
L	250	42	6	M 52 x 2					RED-DKOL-42/06-OMD	99,95
L	250	42	8	M 52 x 2					RED-DKOL-42/08-OMD	98,44
L	250	42	10	M 52 x 2					RED-DKOL-42/10-OMD	97,88
L	250	42	12	M 52 x 2					RED-DKOL-42/12-OMD	99,39
L	250	42	15	M 52 x 2					RED-DKOL-42/15-OMD	99,68
L	250	42	18	M 52 x 2					RED-DKOL-42/18-OMD	99,52
L	250	42	22	M 52 x 2					RED-DKOL-42/22-OMD	99,62
L	250	42	28	M 52 x 2					RED-DKOL-42/28-OMD	99,68
L	250	42	35	M 52 x 2					RED-DKOL-42/35-OMD	98,02

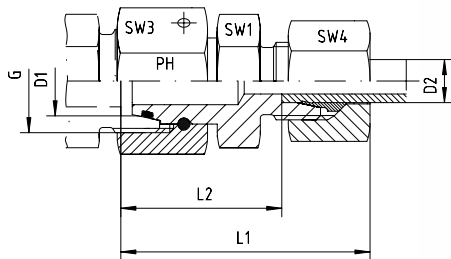

Mit Dichtkegel und O-Ring (DKO) - Viton
Passend in Bohrungsform W DIN 3861
Andere Abmessungen auf Anfrage!

With Taper and O-ring - Viton
For Type of Port End W DIN 3861
Other dimensions on request!

Reihe Series	Druck Pressure PN	Rohr A.D. Tube O.D.		Gewinde Thread G	Ca. Maße Approx. Dimensions					Bestellzeichen Order-Code Standard	Brutto-Preis Gross-Price Euro (€)
		D1	D2		L1	L2	SW1	SW3	SW4		
S	800	8	6	M 16 x 1,5	42	27,0	14	19	17	RED-DKOS-08/06	23,01
S	800	10	6	M 18 x 1,5	42	27,5	17	22	17	RED-DKOS-10/06	23,62
S	800	10	8	M 18 x 1,5	42	27,5	17	22	19	RED-DKOS-10/08	24,03
S	630	12	6	M 20 x 1,5	44	29,0	17	24	17	RED-DKOS-12/06	25,31
S	630	12	8	M 20 x 1,5	44	29,0	17	24	19	RED-DKOS-12/08	26,59
S	630	12	10	M 20 x 1,5	46	29,5	19	24	22	RED-DKOS-12/10	28,12
S	630	14	6	M 22 x 1,5	46	31,5	19	27	17	RED-DKOS-14/06	26,74
S	630	14	8	M 22 x 1,5	46	31,5	19	27	19	RED-DKOS-14/08	28,02
S	630	14	10	M 22 x 1,5	47	31,0	19	27	22	RED-DKOS-14/10	28,12
S	630	14	12	M 22 x 1,5	47	31,0	22	27	24	RED-DKOS-14/12	33,69
S	630	16	6	M 24 x 1,5	47	32,0	22	30	17	RED-DKOS-16/06	33,75
S	630	16	8	M 24 x 1,5	47	32,0	22	30	19	RED-DKOS-16/08	34,31
S	630	16	10	M 24 x 1,5	48	31,5	22	30	22	RED-DKOS-16/10	35,79
S	630	16	12	M 24 x 1,5	48	31,5	22	30	24	RED-DKOS-16/12	35,79
S	630	16	14	M 24 x 1,5	51	33,0	22	30	27	RED-DKOS-16/14	36,81
S	420	20	6	M 30 x 2	51	36,0	27	36	17	RED-DKOS-20/06	37,27
S	420	20	8	M 30 x 2	51	36,0	27	36	19	RED-DKOS-20/08	38,40
S	420	20	10	M 30 x 2	52	35,5	27	36	22	RED-DKOS-20/10	42,03
S	420	20	12	M 30 x 2	52	35,5	27	36	24	RED-DKOS-20/12	42,80
S	420	20	14	M 30 x 2	55	37,0	27	36	27	RED-DKOS-20/14	47,04
S	420	20	16	M 30 x 2	55	36,5	27	36	30	RED-DKOS-20/16	51,64
S	420	25	6	M 36 x 2	53	38,5	32	41	17	RED-DKOS-25/06	56,75
S	420	25	8	M 36 x 2	53	38,5	32	41	19	RED-DKOS-25/08	58,29
S	420	25	10	M 36 x 2	54	38,0	32	41	22	RED-DKOS-25/10	59,82
S	420	25	12	M 36 x 2	54	38,0	32	41	24	RED-DKOS-25/12	60,33
S	420	25	14	M 36 x 2	57	39,5	32	41	27	RED-DKOS-25/14	63,99
S	420	25	16	M 36 x 2	57	39,0	32	41	30	RED-DKOS-25/16	65,96
S	420	25	20	M 36 x 2	61	39,0	32	41	36	RED-DKOS-25/20	74,65
S	420	30	6	M 42 x 2	59	44,0	41	50	17	RED-DKOS-30/06	90,50
S	420	30	8	M 42 x 2	59	44,0	41	50	19	RED-DKOS-30/08	92,55
S	420	30	10	M 42 x 2	60	43,5	41	50	22	RED-DKOS-30/10	94,08
S	420	30	12	M 42 x 2	60	43,5	41	50	24	RED-DKOS-30/12	96,64
S	420	30	14	M 42 x 2	63	45,0	41	50	27	RED-DKOS-30/14	102,77
S	420	30	16	M 42 x 2	63	44,5	41	50	30	RED-DKOS-30/16	104,31
S	420	30	20	M 42 x 2	66	44,5	41	50	36	RED-DKOS-30/20	105,84
S	420	30	25	M 42 x 2	69	45,0	41	50	46	RED-DKOS-30/25	111,46
S	420	38	6	M 52 x 2	63	47,0	50	60	17	RED-DKOS-38/06	120,67
S	420	38	8	M 52 x 2	63	47,0	50	60	19	RED-DKOS-38/08	123,73
S	420	38	10	M 52 x 2	63	47,0	50	60	22	RED-DKOS-38/10	124,76
S	420	38	12	M 52 x 2	63	47,0	50	60	24	RED-DKOS-38/12	126,29
S	420	38	14	M 52 x 2	66	48,5	50	60	27	RED-DKOS-38/14	129,87
S	420	38	16	M 52 x 2	66	48,0	50	60	30	RED-DKOS-38/16	131,40
S	420	38	20	M 52 x 2	70	48,0	50	60	36	RED-DKOS-38/20	132,94
S	420	38	25	M 52 x 2	73	48,5	50	60	46	RED-DKOS-38/25	143,68
S	420	38	30	M 52 x 2	76	49,0	50	60	50	RED-DKOS-38/30	152,37

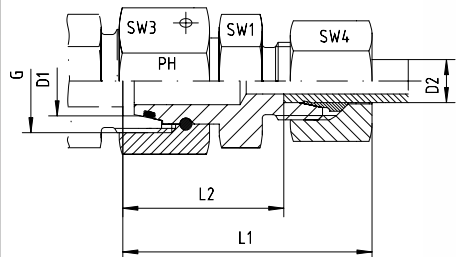

Mit Dichtkegel und O-Ring (DKO) - Viton
Passend in Bohrungsform W DIN 3861
Andere Abmessungen auf Anfrage!

With Taper and O-ring - Viton
For Type of Port End W DIN 3861
Other dimensions on request!

Reihe Series	Druck Pressure PN	Rohr A.D. Tube O.D.		Gewinde Thread G	Ca. Maße Approx. Dimensions					Bestellzeichen Order-Code SC	Brutto-Preis Gross-Price Euro (€)
		D1	D2		L1	L2	SW1	SW3	SW4		
S	800	8	6	M 16 x 1,5	42	27,0	14	19	17	RED-DKOS-08/06-SC	23,45
S	800	10	6	M 18 x 1,5	42	27,5	17	22	17	RED-DKOS-10/06-SC	24,06
S	800	10	8	M 18 x 1,5	42	27,5	17	22	19	RED-DKOS-10/08-SC	24,47
S	630	12	6	M 20 x 1,5	44	29,0	17	24	17	RED-DKOS-12/06-SC	25,75
S	630	12	8	M 20 x 1,5	44	29,0	17	24	19	RED-DKOS-12/08-SC	27,03
S	630	12	10	M 20 x 1,5	46	29,5	19	24	22	RED-DKOS-12/10-SC	28,68
S	630	14	6	M 22 x 1,5	46	31,5	19	27	17	RED-DKOS-14/06-SC	27,18
S	630	14	8	M 22 x 1,5	46	31,5	19	27	19	RED-DKOS-14/08-SC	28,46
S	630	14	10	M 22 x 1,5	47	31,0	19	27	22	RED-DKOS-14/10-SC	28,68
S	630	14	12	M 22 x 1,5	47	31,0	22	27	24	RED-DKOS-14/12-SC	34,53
S	630	16	6	M 24 x 1,5	47	32,0	22	30	17	RED-DKOS-16/06-SC	34,19
S	630	16	8	M 24 x 1,5	47	32,0	22	30	19	RED-DKOS-16/08-SC	34,75
S	630	16	10	M 24 x 1,5	48	31,5	22	30	22	RED-DKOS-16/10-SC	36,35
S	630	16	12	M 24 x 1,5	48	31,5	22	30	24	RED-DKOS-16/12-SC	36,63
S	630	16	14	M 24 x 1,5	51	33,0	22	30	27	RED-DKOS-16/14-SC	38,37
S	420	20	6	M 30 x 2	51	36,0	27	36	17	RED-DKOS-20/06-SC	37,71
S	420	20	8	M 30 x 2	51	36,0	27	36	19	RED-DKOS-20/08-SC	38,84
S	420	20	10	M 30 x 2	52	35,5	27	36	22	RED-DKOS-20/10-SC	42,59
S	420	20	12	M 30 x 2	52	35,5	27	36	24	RED-DKOS-20/12-SC	43,64
S	420	20	14	M 30 x 2	55	37,0	27	36	27	RED-DKOS-20/14-SC	48,60
S	420	20	16	M 30 x 2	55	36,5	27	36	30	RED-DKOS-20/16-SC	53,20
S	420	25	6	M 36 x 2	53	38,5	32	41	17	RED-DKOS-25/06-SC	57,19
S	420	25	8	M 36 x 2	53	38,5	32	41	19	RED-DKOS-25/08-SC	58,73
S	420	25	10	M 36 x 2	54	38,0	32	41	22	RED-DKOS-25/10-SC	60,38
S	420	25	12	M 36 x 2	54	38,0	32	41	24	RED-DKOS-25/12-SC	61,17
S	420	25	14	M 36 x 2	57	39,5	32	41	27	RED-DKOS-25/14-SC	65,55
S	420	25	16	M 36 x 2	57	39,0	32	41	30	RED-DKOS-25/16-SC	67,52
S	420	25	20	M 36 x 2	61	39,0	32	41	36	RED-DKOS-25/20-SC	76,53
S	420	30	6	M 42 x 2	59	44,0	41	50	17	RED-DKOS-30/06-SC	90,94
S	420	30	8	M 42 x 2	59	44,0	41	50	19	RED-DKOS-30/08-SC	92,99
S	420	30	10	M 42 x 2	60	43,5	41	50	22	RED-DKOS-30/10-SC	94,64
S	420	30	12	M 42 x 2	60	43,5	41	50	24	RED-DKOS-30/12-SC	97,48
S	420	30	14	M 42 x 2	63	45,0	41	50	27	RED-DKOS-30/14-SC	104,33
S	420	30	16	M 42 x 2	63	44,5	41	50	30	RED-DKOS-30/16-SC	105,87
S	420	30	20	M 42 x 2	66	44,5	41	50	36	RED-DKOS-30/20-SC	107,72
S	420	30	25	M 42 x 2	69	45,0	41	50	46	RED-DKOS-30/25-SC	114,46
S	420	38	6	M 52 x 2	63	47,0	50	60	17	RED-DKOS-38/06-SC	121,11
S	420	38	8	M 52 x 2	63	47,0	50	60	19	RED-DKOS-38/08-SC	124,17
S	420	38	10	M 52 x 2	63	47,0	50	60	22	RED-DKOS-38/10-SC	125,32
S	420	38	12	M 52 x 2	63	47,0	50	60	24	RED-DKOS-38/12-SC	127,13
S	420	38	14	M 52 x 2	66	48,5	50	60	27	RED-DKOS-38/14-SC	131,43
S	420	38	16	M 52 x 2	66	48,0	50	60	30	RED-DKOS-38/16-SC	132,96
S	420	38	20	M 52 x 2	70	48,0	50	60	36	RED-DKOS-38/20-SC	134,82
S	420	38	25	M 52 x 2	73	48,5	50	60	46	RED-DKOS-38/25-SC	146,68
S	420	38	30	M 52 x 2	76	49,0	50	60	50	RED-DKOS-38/30-SC	156,53



Mit Dichtkegel und O-Ring (DKO) - Viton
Passend in Bohrungsform W DIN 3861
Andere Abmessungen auf Anfrage!

With Taper and O-ring - Viton
For Type of Port End W DIN 3861
Other dimensions on request!

Reihe Series	Druck Pressure PN	Rohr A.D. Tube O.D.		Gewinde Thread G	Ca. Maße Approx. Dimensions				Bestellzeichen Order-Code OMD	Brutto-Preis Gross-Price Euro (€)
		D1	D2							
S	800	8	6	M 16 x 1,5					RED-DKOS-08/06-OMD	20,22
S	800	10	6	M 18 x 1,5					RED-DKOS-10/06-OMD	20,83
S	800	10	8	M 18 x 1,5					RED-DKOS-10/08-OMD	20,83
S	630	12	6	M 20 x 1,5					RED-DKOS-12/06-OMD	22,52
S	630	12	8	M 20 x 1,5					RED-DKOS-12/08-OMD	23,39
S	630	12	10	M 20 x 1,5					RED-DKOS-12/10-OMD	24,18
S	630	14	6	M 22 x 1,5					RED-DKOS-14/06-OMD	23,95
S	630	14	8	M 22 x 1,5					RED-DKOS-14/08-OMD	24,82
S	630	14	10	M 22 x 1,5					RED-DKOS-14/10-OMD	24,18
S	630	14	12	M 22 x 1,5					RED-DKOS-14/12-OMD	29,24
S	630	16	6	M 24 x 1,5					RED-DKOS-16/06-OMD	30,96
S	630	16	8	M 24 x 1,5					RED-DKOS-16/08-OMD	31,11
S	630	16	10	M 24 x 1,5					RED-DKOS-16/10-OMD	31,85
S	630	16	12	M 24 x 1,5					RED-DKOS-16/12-OMD	31,34
S	630	16	14	M 24 x 1,5					RED-DKOS-16/14-OMD	31,31
S	420	20	6	M 30 x 2					RED-DKOS-20/06-OMD	34,48
S	420	20	8	M 30 x 2					RED-DKOS-20/08-OMD	35,20
S	420	20	10	M 30 x 2					RED-DKOS-20/10-OMD	38,09
S	420	20	12	M 30 x 2					RED-DKOS-20/12-OMD	38,35
S	420	20	14	M 30 x 2					RED-DKOS-20/14-OMD	41,54
S	420	20	16	M 30 x 2					RED-DKOS-20/16-OMD	43,43
S	420	25	6	M 36 x 2					RED-DKOS-25/06-OMD	53,96
S	420	25	8	M 36 x 2					RED-DKOS-25/08-OMD	55,09
S	420	25	10	M 36 x 2					RED-DKOS-25/10-OMD	55,88
S	420	25	12	M 36 x 2					RED-DKOS-25/12-OMD	55,88
S	420	25	14	M 36 x 2					RED-DKOS-25/14-OMD	58,49
S	420	25	16	M 36 x 2					RED-DKOS-25/16-OMD	57,75
S	420	25	20	M 36 x 2					RED-DKOS-25/20-OMD	64,07
S	420	30	6	M 42 x 2					RED-DKOS-30/06-OMD	87,71
S	420	30	8	M 42 x 2					RED-DKOS-30/08-OMD	89,35
S	420	30	10	M 42 x 2					RED-DKOS-30/10-OMD	90,14
S	420	30	12	M 42 x 2					RED-DKOS-30/12-OMD	92,19
S	420	30	14	M 42 x 2					RED-DKOS-30/14-OMD	97,27
S	420	30	16	M 42 x 2					RED-DKOS-30/16-OMD	96,10
S	420	30	20	M 42 x 2					RED-DKOS-30/20-OMD	95,26
S	420	30	25	M 42 x 2					RED-DKOS-30/25-OMD	92,84
S	420	38	6	M 52 x 2					RED-DKOS-38/06-OMD	117,88
S	420	38	8	M 52 x 2					RED-DKOS-38/08-OMD	120,53
S	420	38	10	M 52 x 2					RED-DKOS-38/10-OMD	120,82
S	420	38	12	M 52 x 2					RED-DKOS-38/12-OMD	121,84
S	420	38	14	M 52 x 2					RED-DKOS-38/14-OMD	124,37
S	420	38	16	M 52 x 2					RED-DKOS-38/16-OMD	123,19
S	420	38	20	M 52 x 2					RED-DKOS-38/20-OMD	122,36
S	420	38	25	M 52 x 2					RED-DKOS-38/25-OMD	125,06
S	420	38	30	M 52 x 2					RED-DKOS-38/30-OMD	128,93

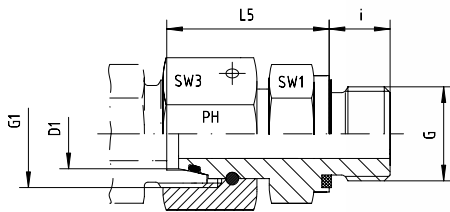

Mit Dichtkegel und O-Ring - Viton
Passend in Bohrungsform W DIN 3861
Einschraubgewinde: Metrisches Feingewinde - Zylindrisch
wd = Abdichtung durch Profildichtung - Viton

With Taper and O-ring - Viton
For Type of Port End W DIN 3861
Thread: Metric - Parallel
wd = Sealing by an Elastomer Profiled Ring - Viton

Reihe Series	Druck Pressure PN	Rohr A.D. Tube O.D. D1	Gewinde Thread		Ca. Maße Approx. Dimensions				Bestellzeichen Order-Code	Brutto-Preis Gross-Price Euro (€)
			G	G1	L5	i	SW1	SW3		
L	500	6	M 10 x 1	M 12 x 1,5	24,5	8	14	14	EGE-DKOL-06-M 10x1-wd	17,38
L	500	8	M 12 x 1,5	M 14 x 1,5	26,5	12	17	17	EGE-DKOL-08-M 12x1,5-wd	18,66
L	500	10	M 14 x 1,5	M 16 x 1,5	27,5	12	19	19	EGE-DKOL-10-M 14x1,5-wd	20,66
L	400	12	M 16 x 1,5	M 18 x 1,5	30,5	12	22	22	EGE-DKOL-12-M 16x1,5-wd	22,75
L	400	15	M 18 x 1,5	M 22 x 1,5	31,5	12	24	27	EGE-DKOL-15-M 18x1,5-wd	29,14
L	400	18	M 22 x 1,5	M 26 x 1,5	31,5	14	27	32	EGE-DKOL-18-M 22x1,5-wd	42,49
L	250	22	M 26 x 1,5	M 30 x 2	32,5	16	32	36	EGE-DKOL-22-M 26x1,5-wd	49,08
L	250	28	M 33 x 2	M 36 x 2	35,0	18	41	41	EGE-DKOL-28-M 33x2-wd	76,69
L	250	35	M 42 x 2	M 45 x 2	42,5	20	50	50	EGE-DKOL-35-M 42x2-wd	120,16
L	250	42	M 48 x 2	M 52 x 2	46,5	22	55	60	EGE-DKOL-42-M 48x2-wd	130,38

Reihe Series	Druck Pressure PN	Rohr A.D. Tube O.D. D1	Gewinde Thread		Ca. Maße Approx. Dimensions				Bestellzeichen Order-Code	Brutto-Preis Gross-Price Euro (€)
			G	G1	L5	i	SW1	SW3		
S	800	6	M 12 x 1,5	M 14 x 1,5	27,0	12	17	17	EGE-DKOS-06-M 12x1,5-wd	18,41
S	800	8	M 14 x 1,5	M 16 x 1,5	29,5	12	19	19	EGE-DKOS-08-M 14x1,5-wd	19,43
S	800	10	M 16 x 1,5	M 18 x 1,5	32,0	12	22	22	EGE-DKOS-10-M 16x1,5-wd	22,39
S	630	12	M 18 x 1,5	M 20 x 1,5	34,0	12	24	24	EGE-DKOS-12-M 18x1,5-wd	27,23
S	630	14	M 20 x 1,5	M 22 x 1,5	36,5	14	27	27	EGE-DKOS-14-M 20x1,5-wd	31,44
S	630	16	M 22 x 1,5	M 24 x 1,5	37,0	14	27	30	EGE-DKOS-16-M 22x1,5-wd	42,67
S	420	20	M 27 x 2	M 30 x 2	43,0	16	32	36	EGE-DKOS-20-M 27x2-wd	58,19
S	420	25	M 33 x 2	M 36 x 2	48,0	18	41	46	EGE-DKOS-25-M 33x2-wd	84,36
S	420	30	M 42 x 2	M 42 x 2	51,0	20	50	50	EGE-DKOS-30-M 42x2-wd	120,16
S	420	38	M 48 x 2	M 52 x 2	60,0	22	55	60	EGE-DKOS-38-M 48x2-wd	150,83

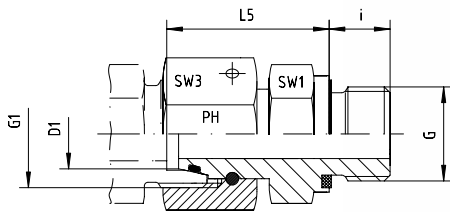

Mit Dichtkegel und O-Ring - Viton
Passend in Bohrungsform W DIN 3861
Einschraubgewinde: Whitworth-Rohrgewinde - Zylindrisch
wd = Abdichtung durch Profildichtung - Viton

With Taper and O-ring - Viton
For Type of Port End W DIN 3861
Thread: BSP - Parallel
wd = Sealing by an Elastomer Profiled Ring - Viton

Reihe Series	Druck Pressure PN	Rohr A.D. Tube O.D. D1	Gewinde Thread		Ca. Maße Approx. Dimensions				Bestellzeichen Order-Code	Brutto-Preis Gross-Price Euro (€)
			G	G1	L5	i	SW1	SW3		
L	500	6	G 1/8"	M 12 x 1,5	24,5	8	14	14	EGE-DKOL-06-G 1/8"-wd	17,33
L	500	6	G 1/4"	M 12 x 1,5	27,0	12	19	14	EGE-DKOL-06-G 1/4"-wd	19,38
L	400	6	G 3/8"	M 12 x 1,5	28,0	12	22	14	EGE-DKOL-06-G 3/8"-wd	24,44
L	500	8	G 1/8"	M 14 x 1,5	25,5	8	14	17	EGE-DKOL-08-G 1/8"-wd	19,65
L	500	8	G 1/4"	M 14 x 1,5	29,5	12	19	17	EGE-DKOL-08-G 1/4"-wd	18,61
L	400	8	G 3/8"	M 14 x 1,5	29,5	12	22	17	EGE-DKOL-08-G 3/8"-wd	24,44
L	400	8	G 1/2"	M 14 x 1,5	29,0	14	27	17	EGE-DKOL-08-G 1/2"-wd	29,91
L	500	10	G 1/8"	M 16 x 1,5	25,5	8	14	19	EGE-DKOL-10-G 1/8"-wd	21,60
L	500	10	G 1/4"	M 16 x 1,5	27,5	12	19	19	EGE-DKOL-10-G 1/4"-wd	20,63
L	400	10	G 3/8"	M 16 x 1,5	30,0	12	22	19	EGE-DKOL-10-G 3/8"-wd	24,44
L	400	10	G 1/2"	M 16 x 1,5	30,0	14	27	19	EGE-DKOL-10-G 1/2"-wd	29,91
L	400	12	G 1/8"	M 18 x 1,5	26,0	8	17	22	EGE-DKOL-12-G 1/8"-wd	22,75
L	400	12	G 1/4"	M 18 x 1,5	28,0	12	19	22	EGE-DKOL-12-G 1/4"-wd	22,75
L	400	12	G 3/8"	M 18 x 1,5	34,0	12	22	22	EGE-DKOL-12-G 3/8"-wd	22,75
L	400	12	G 1/2"	M 18 x 1,5	34,5	14	27	22	EGE-DKOL-12-G 1/2"-wd	29,40
L	400	15	G 3/8"	M 22 x 1,5	35,0	12	24	27	EGE-DKOL-15-G 3/8"-wd	31,96
L	400	15	G 1/2"	M 22 x 1,5	35,0	14	27	27	EGE-DKOL-15-G 1/2"-wd	29,14
L	250	15	G 3/4"	M 22 x 1,5	48,0	16	32	27	EGE-DKOL-15-G 3/4"-wd	48,50
L	400	18	G 3/8"	M 26 x 1,5	34,0	12	24	32	EGE-DKOL-18-G 3/8"-wd	48,80
L	400	18	G 1/2"	M 26 x 1,5	31,5	14	27	32	EGE-DKOL-18-G 1/2"-wd	42,13
L	315	18	G 3/4"	M 26 x 1,5	33,0	16	32	32	EGE-DKOL-18-G 3/4"-wd	48,80
L	250	22	G 1/2"	M 30 x 2	32,0	14	27	36	EGE-DKOL-22-G 1/2"-wd	48,50
L	250	22	G 3/4"	M 30 x 2	32,5	16	32	36	EGE-DKOL-22-G 3/4"-wd	48,93
L	250	22	G 1"	M 30 x 2	33,0	18	41	36	EGE-DKOL-22-G 1"-wd	76,50
L	250	28	G 3/4"	M 36 x 2	35,0	16	32	41	EGE-DKOL-28-G 3/4"-wd	76,60
L	250	28	G 1"	M 36 x 2	35,0	18	41	41	EGE-DKOL-28-G 1"-wd	76,69
L	250	35	G 1 1/4"	M 45 x 2	42,5	20	50	50	EGE-DKOL-35-G 1 1/4"-wd	120,16
L	250	42	G 1 1/4"	M 52 x 2	40,5	20	50	60	EGE-DKOL-42-G 1 1/4"-wd	316,00
L	250	42	G 1 1/2"	M 52 x 2	46,5	22	55	60	EGE-DKOL-42-G 1 1/2"-wd	132,94

Reihe Series	Druck Pressure PN	Rohr A.D. Tube O.D. D1	Gewinde Thread		Ca. Maße Approx. Dimensions				Bestellzeichen Order-Code	Brutto-Preis Gross-Price Euro (€)
			G	G1	L5	i	SW1	SW3		
S	800	6	G 1/4"	M 14 x 1,5	27,0	12	19	17	EGE-DKOS-06-G 1/4"-wd	19,07
S	800	8	G 1/4"	M 16 x 1,5	29,5	12	19	19	EGE-DKOS-08-G 1/4"-wd	19,79
S	800	8	G 3/8"	M 16 x 1,5	29,5	12	22	19	EGE-DKOS-08-G 3/8"-wd	22,50
S	800	10	G 1/4"	M 18 x 1,5	27,5	12	19	22	EGE-DKOS-10-G 1/4"-wd	31,34
S	800	10	G 3/8"	M 18 x 1,5	32,0	12	22	22	EGE-DKOS-10-G 3/8"-wd	22,55
S	630	10	G 1/2"	M 18 x 1,5	32,0	14	27	22	EGE-DKOS-10-G 1/2"-wd	31,34
S	630	12	G 1/4"	M 20 x 1,5	42,0	12	19	24	EGE-DKOS-12-G 1/4"-wd	24,18
S	630	12	G 3/8"	M 20 x 1,5	34,0	12	22	24	EGE-DKOS-12-G 3/8"-wd	24,18
S	630	12	G 1/2"	M 20 x 1,5	34,5	14	27	24	EGE-DKOS-12-G 1/2"-wd	31,34
S	630	14	G 1/2"	M 22 x 1,5	36,5	14	27	27	EGE-DKOS-14-G 1/2"-wd	31,34
S	630	16	G 3/8"	M 24 x 1,5	37,0	12	24	30	EGE-DKOS-16-G 3/8"-wd	43,25
S	630	16	G 1/2"	M 24 x 1,5	37,0	14	27	30	EGE-DKOS-16-G 1/2"-wd	43,46
S	420	16	G 3/4"	M 24 x 1,5	39,0	16	32	30	EGE-DKOS-16-G 3/4"-wd	57,45
S	420	20	G 1/2"	M 30 x 2	38,0	14	27	36	EGE-DKOS-20-G 1/2"-wd	57,60
S	420	20	G 3/4"	M 30 x 2	43,0	16	32	36	EGE-DKOS-20-G 3/4"-wd	57,78
S	420	20	G 1"	M 30 x 2	55,0	18	41	36	EGE-DKOS-20-G 1"-wd	84,10
S	420	25	G 3/4"	M 36 x 2	58,0	16	32	46	EGE-DKOS-25-G 3/4"-wd	84,25
S	420	25	G 1"	M 36 x 2	48,0	18	41	46	EGE-DKOS-25-G 1"-wd	84,36
S	420	30	G 1"	M 42 x 2	46,0	18	41	50	EGE-DKOS-30-G 1"-wd	99,70
S	420	30	G 1 1/4"	M 42 x 2	51,0	20	50	50	EGE-DKOS-30-G 1 1/4"-wd	99,70
S	420	38	G 1 1/2"	M 52 x 2	60,0	22	55	60	EGE-DKOS-38-G 1 1/2"-wd	148,28

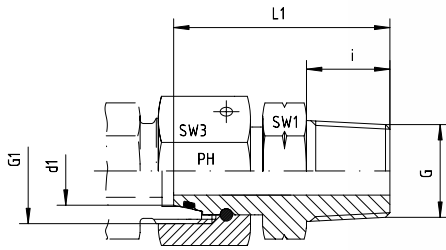

Mit Dichtkegel und O-Ring - Viton
Passend in Bohrungsform W DIN 3861
Einschraubgewinde: NPT

With Taper and O-ring - Viton
For Type of Port End W DIN 3861
Thread: NPT

Reihe Series	Druck Pressure PN	Rohr A.D. Tube O.D. D1	Gewinde Thread		Ca. Maße Approx. Dimensions				Bestellzeichen Order-Code	Brutto-Preis Gross-Price Euro (€)
			G	G1	L1	i	SW1	SW3		
L	500	6	1/8" NPT	M 12 x 1,5	32,0	10,0	12	14	EGE-DKOL-06-NPT-1/8"	21,05
L	500	6	1/4" NPT	M 12 x 1,5	38,0	15,0	14	14	EGE-DKOL-06-NPT-1/4"	25,20
L	500	8	1/4" NPT	M 14 x 1,5	42,5	15,0	14	17	EGE-DKOL-08-NPT-1/4"	22,60
L	500	10	1/4" NPT	M 16 x 1,5	42,5	15,0	14	19	EGE-DKOL-10-NPT-1/4"	25,05
L	400	10	3/8" NPT	M 16 x 1,5	43,0	15,3	19	19	EGE-DKOL-10-NPT-3/8"	31,77
L	400	12	1/4" NPT	M 18 x 1,5	40,0	15,0	17	22	EGE-DKOL-12-NPT-1/4"	29,58
L	400	12	3/8" NPT	M 18 x 1,5	40,0	15,3	19	22	EGE-DKOL-12-NPT-3/8"	27,60
L	400	12	1/2" NPT	M 18 x 1,5	47,0	20,0	22	22	EGE-DKOL-12-NPT-1/2"	38,22
L	400	15	1/2" NPT	M 22 x 1,5	49,0	20,0	22	27	EGE-DKOL-15-NPT-1/2"	35,40
L	400	18	1/2" NPT	M 26 x 1,5	49,0	20,0	24	32	EGE-DKOL-18-NPT-1/2"	51,15
L	250	22	1/2" NPT	M 30 x 2	49,0	20,0	27	36	EGE-DKOL-22-NPT-1/2"	63,05
L	250	22	3/4" NPT	M 30 x 2	50,0	20,0	27	36	EGE-DKOL-22-NPT-3/4"	59,45
L	250	28	1" NPT	M 36 x 2	61,0	25,0	36	41	EGE-DKOL-28-NPT-1"	93,15
L	250	35	1 1/4" NPT	M 45 x 2	60,5	25,5	46	50	EGE-DKOL-35-NPT-1 1/4"	145,95
L	250	42	1 1/2" NPT	M 52 x 2	63,0	26,0	50	60	EGE-DKOL-42-NPT-1 1/2"	161,45

Reihe Series	Druck Pressure PN	Rohr A.D. Tube O.D. D1	Gewinde Thread		Ca. Maße Approx. Dimensions				Bestellzeichen Order-Code	Brutto-Preis Gross-Price Euro (€)
			G	G1	L1	i	SW1	SW3		
S	800	6	1/4" NPT	M 14 x 1,5	38,0	15,0	14	17	EGE-DKOS-06-NPT-1/4"	23,15
S	800	8	1/4" NPT	M 16 x 1,5	39,0	15,0	14	19	EGE-DKOS-08-NPT-1/4"	24,00
S	800	10	3/8" NPT	M 18 x 1,5	40,0	15,3	19	22	EGE-DKOS-10-NPT-3/8"	27,35
S	630	12	1/4" NPT	M 20 x 1,5	41,5	15,0	17	24	EGE-DKOS-12-NPT-1/4"	31,43
S	630	12	3/8" NPT	M 20 x 1,5	41,5	15,3	19	24	EGE-DKOS-12-NPT-3/8"	29,35
S	630	12	1/2" NPT	M 20 x 1,5	48,0	20,0	22	24	EGE-DKOS-12-NPT-1/2"	40,74
S	630	14	1/2" NPT	M 22 x 1,5	48,0	20,0	22	27	EGE-DKOS-14-NPT-1/2"	38,05
S	630	16	3/8" NPT	M 24 x 1,5	45,0	15,3	22	30	EGE-DKOS-16-NPT-3/8"	56,23
S	630	16	1/2" NPT	M 24 x 1,5	49,0	20,0	22	30	EGE-DKOS-16-NPT-1/2"	52,75
S	420	16	3/4" NPT	M 24 x 1,5	49,0	20,0	27	30	EGE-DKOS-16-NPT-3/4"	74,70
S	420	20	3/4" NPT	M 30 x 2	52,0	20,0	27	36	EGE-DKOS-20-NPT-3/4"	70,15
S	420	25	1" NPT	M 36 x 2	66,0	25,0	36	46	EGE-DKOS-25-NPT-1"	102,45
S	420	30	1 1/4" NPT	M 42 x 2	65,5	25,5	46	50	EGE-DKOS-30-NPT-1 1/4"	121,10
S	420	38	1 1/2" NPT	M 52 x 2	66,0	26,0	50	60	EGE-DKOS-38-NPT-1 1/2"	180,10



Einstellbare Manometer-Verschraubung mit
Dichtkegel und O-Ring - Viton
Passend in Bohrungsform W DIN 3861

For Pressure Gauge Connection with Taper and
O-ring - Viton
For Type of Port End W DIN 3861

Reihe Series	Druck Pressure PN	Rohr A.D. Tube O.D. D1	Gewinde Thread		Ca. Maße Approx. Dimensions					Bestellzeichen Order-Code	Brutto-Preis Gross-Price Euro (€)
			G	G1	L	i	H	SW1	SW3		
L	315	6	1/4"	M 12 x 1,5	35,5	14,5	4,5	19	14	MVE-DKOL-06-G 1/4"	15,57
L	315	6	1/2"	M 12 x 1,5	43,0	20,0	5,0	27	14	MVE-DKOL-06-G 1/2"	24,25
L	315	8	1/4"	M 14 x 1,5	35,5	14,5	4,5	19	17	MVE-DKOL-08-G 1/4"	16,11
L	315	8	1/2"	M 14 x 1,5	43,7	20,0	5,0	27	17	MVE-DKOL-08-G 1/2"	24,75
L	315	10	1/4"	M 16 x 1,5	36,0	14,5	4,5	19	19	MVE-DKOL-10-G 1/4"	17,03
L	315	10	1/2"	M 16 x 1,5	43,7	20,0	5,0	27	19	MVE-DKOL-10-G 1/2"	25,75
L	315	12	1/4"	M 18 x 1,5	36,0	14,5	4,5	19	22	MVE-DKOL-12-G 1/4"	17,64
L	315	12	1/2"	M 18 x 1,5	44,0	20,0	5,0	27	22	MVE-DKOL-12-G 1/2"	26,50

Reihe Series	Druck Pressure PN	Rohr A.D. Tube O.D. D1	Gewinde Thread		Ca. Maße Approx. Dimensions					Bestellzeichen Order-Code	Brutto-Preis Gross-Price Euro (€)
			G	G1	L	i	H	SW1	SW3		
S	630	6	1/4"	M 14 x 1,5	36,0	14,5	4,5	19	17	MVE-DKOS-06-G 1/4"	22,24
S	630	6	1/2"	M 14 x 1,5	43,0	20,0	5,0	27	17	MVE-DKOS-06-G 1/2"	22,24
S	630	8	1/4"	M 16 x 1,5	37,5	14,5	4,5	19	19	MVE-DKOS-08-G 1/4"	22,75
S	630	8	1/2"	M 16 x 1,5	43,0	20,0	5,0	27	19	MVE-DKOS-08-G 1/2"	22,75
S	630	10	1/4"	M 18 x 1,5	37,5	14,5	4,5	19	22	MVE-DKOS-10-G 1/4"	23,75
S	630	10	1/2"	M 18 x 1,5	43,5	20,0	5,0	27	22	MVE-DKOS-10-G 1/2"	23,75
S	630	12	1/4"	M 20 x 1,5	39,0	14,5	4,5	19	24	MVE-DKOS-12-G 1/4"	24,47
S	630	12	1/2"	M 20 x 1,5	45,0	20,0	5,0	27	24	MVE-DKOS-12-G 1/2"	24,47

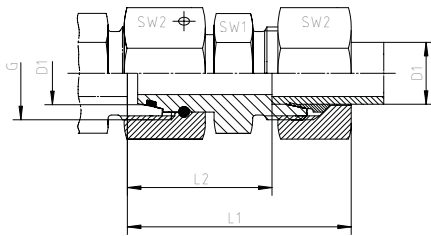

Mit Dichtkegel und O-Ring (DKO) - Viton
Passend in Bohrungsform W DIN 3861

With Taper and O-ring - Viton
For Type of Port End W DIN 3861

Reihe Series	Druck Pressure PN	Rohr A.D. Tube O.D. D1	Gewinde Thread G	Ca. Maße Approx. Dimensions				Bestellzeichen Order-Code Standard	Brutto-Preis Gross-Price Euro (€)
				L1	L2	SW1	SW2		
L	500	6	M 12 x 1,5	51,0	36,0	12	14	DA-DKOL-06	29,91
L	500	8	M 14 x 1,5	51,0	36,0	14	17	DA-DKOL-08	32,97
L	500	10	M 16 x 1,5	51,0	36,0	17	19	DA-DKOL-10	37,91
L	400	12	M 18 x 1,5	51,0	36,0	19	22	DA-DKOL-12	42,93
L	400	15	M 22 x 1,5	51,0	36,0	24	27	DA-DKOL-15	55,74
L	400	18	M 26 x 1,5	52,0	36,0	27	32	DA-DKOL-18	82,83
L	250	22	M 30 x 2	56,0	40,0	32	36	DA-DKOL-22	102,31
L	250	28	M 36 x 2	57,0	40,0	41	41	DA-DKOL-28	129,80
L	250	35	M 45 x 2	72,0	50,0	46	50	DA-DKOL-35	184,51
L	250	42	M 52 x 2	83,0	60,0	55	60	DA-DKOL-42	209,83

Reihe Series	Druck Pressure PN	Rohr A.D. Tube O.D. D1	Gewinde Thread G	Ca. Maße Approx. Dimensions				Bestellzeichen Order-Code Standard	Brutto-Preis Gross-Price Euro (€)
				L1	L2	SW1	SW2		
S	800	6	M 14 x 1,5	51,0	36,0	14	17	DA-DKOS-06	31,91
S	800	8	M 16 x 1,5	51,0	36,0	17	19	DA-DKOS-08	38,06
S	800	10	M 18 x 1,5	52,0	36,0	19	22	DA-DKOS-10	43,27
S	630	12	M 20 x 1,5	52,0	36,0	22	24	DA-DKOS-12	51,57
S	630	14	M 22 x 1,5	58,0	40,0	24	27	DA-DKOS-14	58,89
S	630	16	M 24 x 1,5	58,0	40,0	27	30	DA-DKOS-16	79,17
S	420	20	M 30 x 2	68,0	46,0	32	36	DA-DKOS-20	102,44
S	420	25	M 36 x 2	74,0	50,0	41	46	DA-DKOS-25	130,72
S	420	30	M 42 x 2	83,0	56,0	46	50	DA-DKOS-30	188,74
S	420	38	M 52 x 2	91,0	60,0	55	60	DA-DKOS-38	219,91



Mit Dichtkegel und O-Ring (DKO) - Viton
Passend in Bohrungsform W DIN 3861

With Taper and O-ring - Viton
For Type of Port End W DIN 3861

Reihe Series	Druck Pressure PN	Rohr A.D. Tube O.D. D1	Gewinde Thread G	Ca. Maße Approx. Dimensions				Bestellzeichen Order-Code SC	Brutto-Preis Gross-Price Euro (€)
				L1	L2	SW1	SW2		
L	500	6	M 12 x 1,5	51,0	36,0	12	14	DA-DKOL-06-SC	30,33
L	500	8	M 14 x 1,5	51,0	36,0	14	17	DA-DKOL-08-SC	33,54
L	500	10	M 16 x 1,5	51,0	36,0	17	19	DA-DKOL-10-SC	38,49
L	400	12	M 18 x 1,5	51,0	36,0	19	22	DA-DKOL-12-SC	43,66
L	400	15	M 22 x 1,5	51,0	36,0	24	27	DA-DKOL-15-SC	57,06
L	400	18	M 26 x 1,5	52,0	36,0	27	32	DA-DKOL-18-SC	84,91
L	250	22	M 30 x 2	56,0	40,0	32	36	DA-DKOL-22-SC	104,59
L	250	28	M 36 x 2	57,0	40,0	41	41	DA-DKOL-28-SC	132,51
L	250	35	M 45 x 2	72,0	50,0	46	50	DA-DKOL-35-SC	189,28
L	250	42	M 52 x 2	83,0	60,0	55	60	DA-DKOL-42-SC	215,52

Reihe Series	Druck Pressure PN	Rohr A.D. Tube O.D. D1	Gewinde Thread G	Ca. Maße Approx. Dimensions				Bestellzeichen Order-Code SC	Brutto-Preis Gross-Price Euro (€)
				L1	L2	SW1	SW2		
S	800	6	M 14 x 1,5	51,0	36,0	14	17	DA-DKOS-06-SC	32,48
S	800	8	M 16 x 1,5	51,0	36,0	17	19	DA-DKOS-08-SC	38,65
S	800	10	M 18 x 1,5	52,0	36,0	19	22	DA-DKOS-10-SC	44,01
S	630	12	M 20 x 1,5	52,0	36,0	22	24	DA-DKOS-12-SC	52,62
S	630	14	M 22 x 1,5	58,0	40,0	24	27	DA-DKOS-14-SC	60,74
S	630	16	M 24 x 1,5	58,0	40,0	27	30	DA-DKOS-16-SC	81,15
S	420	20	M 30 x 2	68,0	46,0	32	36	DA-DKOS-20-SC	104,86
S	420	25	M 36 x 2	74,0	50,0	41	46	DA-DKOS-25-SC	134,68
S	420	30	M 42 x 2	83,0	56,0	46	50	DA-DKOS-30-SC	194,10
S	420	38	M 52 x 2	91,0	60,0	55	60	DA-DKOS-38-SC	227,23

Mit Dichtkegel und O-Ring (DKO) - Viton
Passend in Bohrungsform W DIN 3861

*With Taper and O-ring - Viton
For Type of Port End W DIN 3861*



Reihe Series	Druck Pressure PN	Rohr A.D. Tube O.D.		Gewinde Thread	Ca. Maße Approx. Dimensions				Bestellzeichen Order-Code OMD	Brutto-Preis Gross-Price Euro (€)
		D1	G							
L	500	6	M 12 x 1,5					DA-DKOL-06-OMD	27,60	
L	500	8	M 14 x 1,5					DA-DKOL-08-OMD	30,17	
L	500	10	M 16 x 1,5					DA-DKOL-10-OMD	34,55	
L	400	12	M 18 x 1,5					DA-DKOL-12-OMD	39,04	
L	400	15	M 22 x 1,5					DA-DKOL-15-OMD	50,60	
L	400	18	M 26 x 1,5					DA-DKOL-18-OMD	74,21	
L	250	22	M 30 x 2					DA-DKOL-22-OMD	92,00	
L	250	28	M 36 x 2					DA-DKOL-28-OMD	114,95	
L	250	35	M 45 x 2					DA-DKOL-35-OMD	163,40	
L	250	42	M 52 x 2					DA-DKOL-42-OMD	182,40	

Reihe Series	Druck Pressure PN	Rohr A.D. Tube O.D.		Gewinde Thread	Ca. Maße Approx. Dimensions				Bestellzeichen Order-Code OMD	Brutto-Preis Gross-Price Euro (€)
		D1	G							
S	800	6	M 14 x 1,5					DA-DKOS-06-OMD	29,12	
S	800	8	M 16 x 1,5					DA-DKOS-08-OMD	34,86	
S	800	10	M 18 x 1,5					DA-DKOS-10-OMD	39,33	
S	630	12	M 20 x 1,5					DA-DKOS-12-OMD	47,12	
S	630	14	M 22 x 1,5					DA-DKOS-14-OMD	53,39	
S	630	16	M 24 x 1,5					DA-DKOS-16-OMD	70,96	
S	420	20	M 30 x 2					DA-DKOS-20-OMD	91,86	
S	420	25	M 36 x 2					DA-DKOS-25-OMD	112,10	
S	420	30	M 42 x 2					DA-DKOS-30-OMD	165,30	
S	420	38	M 52 x 2					DA-DKOS-38-OMD	188,10	











EDELSTAHL / STAINLESS STEEL
VERBINDUNGSTECHNIK
FLUID CONNECTORS

Schweissskegel-Verschraubungen mit O-Ring Weld Nipple Couplings with O-ring





SCHWEISSKEGEL-VERSCHRAUBUNGEN MIT O-RING WELD NIPPLE COUPLINGS WITH O-RING

	Produktgruppen	Product Groups	Seite Page
	Montageanleitung	Assembly Instruction	10.2
	ESV - Schott-Verschraubungen - L- und S-Reihe - ESV - Schott-Verschraubungen - Standard - ESV - Schott-Verschraubungen - SC - ESV - Schott-Verschraubungsstutzen - OMD	ESV - Bulkhead Couplings - L- and S-Series - ESV - Bulkhead Couplings - Standard - ESV - Bulkhead Couplings - SC - ESV - Bulkhead Coupling Bodies - OMD	10.3 10.4 10.5
	ASV - Gerade Verschraubungen - L- und S-Reihe - ASV - Gerade Verschraubungen - Standard - ASV - Gerade Verschraubungen - SC - ASV - Gerade Verschraubungsstutzen - OMD	ASV - Couplings - L- and S-Series - ASV - Couplings - Standard - ASV - Couplings - SC - ASV - Coupling Bodies - OMD	10.6 10.7 10.8
	WAS - Winkel-Verschraubungen - L- und S-Reihe - WAS - Winkel-Verschraubungen - Standard - WAS - Winkel-Verschraubungen - SC - WAS - Winkel-Verschraubungsstutzen - OMD	WAS - Couplings - L- and S-Series - WAS - Couplings - Standard - WAS - Couplings - SC - WAS - Coupling Bodies - OMD	10.9 10.10 10.11
	Gerade Schweißkegel-Verschraubungen - L- und S-Reihe - Gerade Schweißkegel-Verschraubungen - Standard - Gerade Schweißkegel-Verschraubungen - SC - Gerade Schweißkegel-Verschraubungsstutzen - OMD	Welding Nipple Couplings - L- and S-Series - Welding Nipple Couplings - Standard - Welding Nipple Couplings - SC - Welding Nipple Coupling Bodies - OMD	10.12 10.13 10.14
	Schweißnippel	Welding Nipples	10.15
	Schweißnippel-Reduzierungen	Welding Nipple Reducings	10.16
	Schweißnippel-Rohrbögen - 90°	Welding Nipple Elbows - 90°	10.17

Standard = Überwurfmutter blank / Tube nuts are supplied unplated
SC = Überwurfmutter bis Größe 12-S ist ist gleitbeschichtet / Tube nuts until size 12-L are supplied chemical plated
 = Überwurfmutter ab Größe 12-S ist mit versilbertem Gewinde / Tube nuts from size 12-S are supplied with silver plated thread
OMD = Verschraubung ohne Überwurfmutter und Schneidring am Außengewinde / Couplings are supplied without nut and cutting ring at male thread

1. Rohr rechtwinkelig ablängen, entgraten und anfasen für V-Naht nach DIN 2559.
2. Überwurfmutter, wie abgebildet, über den Schweißkegel schieben.

1. Cut tube at right angles and chamfer it for V-welding seam to DIN 2559.
2. Slide nut over weld nipple arrangement as shown above.

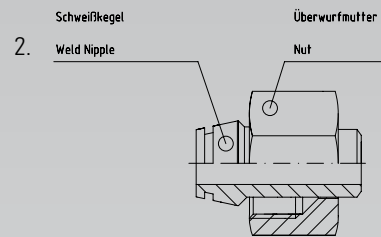
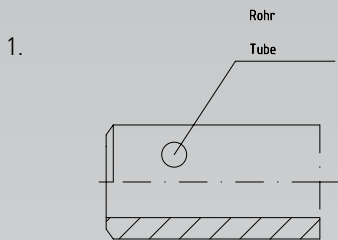

3. Schweißkegel und Rohr nach den Schweißrichtlinien verschweißen. Darauf achten, dass keine Schweißperlen ins Rohrinne gelangen. Kegel, Nut und Stutzenkonus müssen sauber sein.
4. O-Ring erst nach dem Schweißen in die Nut einlegen. Er darf sich nicht verdrehen. Schweißkegel, Konus und Innen- und Außengewinde einölen, nicht einfetten.

3. Weld nipple and tube are welded according to the general welding instructions. Please ensure that no globules of weld enter the inside of the tube. Nipple, groove and taper must be clean.
4. O-ring is only to be inserted into groove after welding. O-ring must not be twisted. Do not grease, but oil nipple, taper inside and outside of thread.

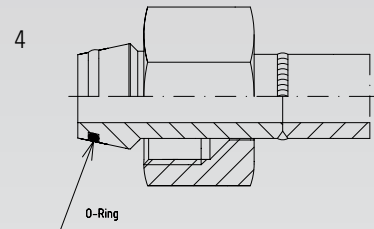
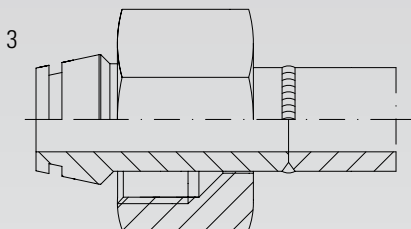

5. Überwurfmutter von Hand auf den Stutzen schrauben, dann mit dem Schlüssel ca. 1/4 - 1/3 Umdrehung anziehen. Das Rohr mit angeschweißtem Kegel muss spannungsfrei verschraubt und verlegt werden.

5. Screw the nut by hand onto the body, tighten nut with a spanner approx. 1/4 – 1/3 of a turn. Tube with welded nipple has to be installed free of tension.

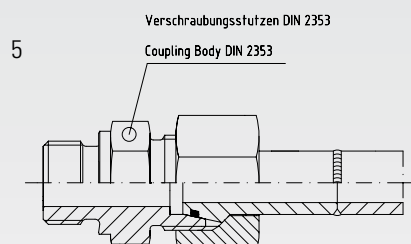



Einschweiß-Schottverschraubungen

Welding Bulkhead Connections

Reihe Series	Druck Pressure PN	Rohr A.D. Tube O.D.		Ca. Maße Approx. Dimensions			Bestellzeichen Order-Code Standard	Brutto-Preis Gross-Price Euro (€)
		D1	D2	L1	L2	SW3		
L	500	6	18	85	56	14	ESV-L-06	18,15
L	500	8	20	85	56	17	ESV-L-08	19,79
L	500	10	22	87	58	19	ESV-L-10	23,52
L	400	12	25	87	58	22	ESV-L-12	26,33
L	400	15	28	100	70	27	ESV-L-15	37,73
L	400	18	32	101	69	32	ESV-L-18	49,60
L	250	22	36	105	73	36	ESV-L-22	74,14
L	250	28	40	106	73	41	ESV-L-28	94,59
L	250	35	50	114	71	50	ESV-L-35	120,16
L	250	42	60	115	70	60	ESV-L-42	176,40

Reihe Series	Druck Pressure PN	Rohr A.D. Tube O.D.		Ca. Maße Approx. Dimensions			Bestellzeichen Order-Code Standard	Brutto-Preis Gross-Price Euro (€)
		D1	D2	L1	L2	SW3		
S	800	6	20	89	60	17	ESV-S-06	20,96
S	800	8	22	89	60	19	ESV-S-08	23,98
S	800	10	25	91	59	22	ESV-S-10	28,12
S	630	12	28	91	59	24	ESV-S-12	32,88
S	630	14	30	107	72	27	ESV-S-14	45,89
S	630	16	35	107	71	30	ESV-S-16	55,53
S	420	20	38	114	71	36	ESV-S-20	92,03
S	420	25	45	120	72	46	ESV-S-25	99,70
S	420	30	50	126	73	50	ESV-S-30	122,71
S	420	38	60	133	72	60	ESV-S-38	176,40



Einschweiß-Schottverschraubungen

Welding Bulkhead Connections

Reihe Series	Druck Pressure PN	Rohr A.D. Tube O.D.		Ca. Maße Approx. Dimensions			Bestellzeichen Order-Code SC	Brutto-Preis Gross-Price Euro (€)
		D1	D2	L1	L2	SW3		
L	500	6	18	85	56	14	ESV-L-06-SC	18,79
L	500	8	20	85	56	17	ESV-L-08-SC	20,67
L	500	10	22	87	58	19	ESV-L-10-SC	24,40
L	400	12	25	87	58	22	ESV-L-12-SC	27,45
L	400	15	28	100	70	27	ESV-L-15-SC	39,89
L	400	18	32	101	69	32	ESV-L-18-SC	52,88
L	250	22	36	105	73	36	ESV-L-22-SC	77,66
L	250	28	40	106	73	41	ESV-L-28-SC	98,59
L	250	35	50	114	71	50	ESV-L-35-SC	127,60
L	250	42	60	115	70	60	ESV-L-42-SC	185,04

Reihe Series	Druck Pressure PN	Rohr A.D. Tube O.D.		Ca. Maße Approx. Dimensions			Bestellzeichen Order-Code SC	Brutto-Preis Gross-Price Euro (€)
		D1	D2	L1	L2	SW3		
S	800	6	20	89	60	17	ESV-S-06-SC	21,84
S	800	8	22	89	60	19	ESV-S-08-SC	24,86
S	800	10	25	91	59	22	ESV-S-10-SC	29,24
S	630	12	28	91	59	24	ESV-S-12-SC	34,56
S	630	14	30	107	72	27	ESV-S-14-SC	49,01
S	630	16	35	107	71	30	ESV-S-16-SC	58,65
S	420	20	38	114	71	36	ESV-S-20-SC	95,79
S	420	25	45	120	72	46	ESV-S-25-SC	105,70
S	420	30	50	126	73	50	ESV-S-30-SC	131,03
S	420	38	60	133	72	60	ESV-S-38-SC	187,68

Einschweiß-Schottverschraubungsstutzen

Welding Bulkhead Connection Bodies



Reihe Series	Druck Pressure PN	Rohr A.D. Tube O.D.		Ca. Maße Approx. Dimensions			Bestellzeichen Order-Code OMD	Brutto-Preis Gross-Price Euro (€)
		D1	D2					
L	500	6	18				ESV-L-06-OMD	13,53
L	500	8	20				ESV-L-08-OMD	14,19
L	500	10	22				ESV-L-10-OMD	16,80
L	400	12	25				ESV-L-12-OMD	18,55
L	400	15	28				ESV-L-15-OMD	27,45
L	400	18	32				ESV-L-18-OMD	32,36
L	250	22	36				ESV-L-22-OMD	53,52
L	250	28	40				ESV-L-28-OMD	64,89
L	250	35	50				ESV-L-35-OMD	77,94
L	250	42	60				ESV-L-42-OMD	121,54

Reihe Series	Druck Pressure PN	Rohr A.D. Tube O.D.		Ca. Maße Approx. Dimensions			Bestellzeichen Order-Code OMD	Brutto-Preis Gross-Price Euro (€)
		D1	D2					
S	800	6	20				ESV-S-06-OMD	15,38
S	800	8	22				ESV-S-08-OMD	17,58
S	800	10	25				ESV-S-10-OMD	20,24
S	630	12	28				ESV-S-12-OMD	23,98
S	630	14	30				ESV-S-14-OMD	34,89
S	630	16	35				ESV-S-16-OMD	39,11
S	420	20	38				ESV-S-20-OMD	70,87
S	420	25	45				ESV-S-25-OMD	62,46
S	420	30	50				ESV-S-30-OMD	75,83
S	420	38	60				ESV-S-38-OMD	113,12

Gerade Anschweißverschraubungen

Straight Welding Bosses

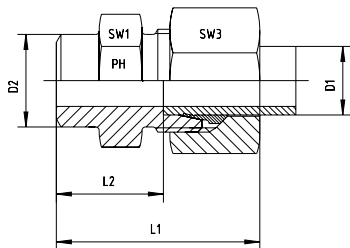

Reihe Series	Druck Pressure PN	Rohr A.D. Tube O.D.		Ca. Maße Approx. Dimensions				Bestellzeichen Order-Code Standard	Brutto-Preis Gross-Price Euro (€)
		D1	D2	L1	L2	SW1	SW3		
L	500	6	10	29	14,0	12	14	ASV-L-06	8,18
L	500	8	12	31	16,0	14	17	ASV-L-08	9,02
L	500	10	14	33	18,0	17	19	ASV-L-10	10,89
L	400	12	16	33	18,0	19	27	ASV-L-12	11,27
L	400	15	19	37	22,0	22	27	ASV-L-15	14,19
L	400	18	22	40	23,5	27	32	ASV-L-18	23,42
L	250	22	27	45	28,5	32	36	ASV-L-22	31,19
L	250	28	32	47	30,5	41	41	ASV-L-28	45,51
L	250	35	40	54	32,5	46	50	ASV-L-35	58,80
L	250	42	46	58	35,0	55	60	ASV-L-42	79,25

Reihe Series	Druck Pressure PN	Rohr A.D. Tube O.D.		Ca. Maße Approx. Dimensions				Bestellzeichen Order-Code Standard	Brutto-Preis Gross-Price Euro (€)
		D1	D2	L1	L2	SW1	SW3		
S	800	6	11	34	19,0	14	17	ASV-S-06	10,79
S	800	8	13	36	21,0	17	19	ASV-S-08	12,22
S	800	10	15	39	22,5	19	22	ASV-S-10	13,37
S	630	12	17	41	24,5	22	24	ASV-S-12	13,55
S	630	14	19	45	27,0	24	27	ASV-S-14	18,05
S	630	16	21	45	26,5	27	30	ASV-S-16	23,88
S	420	20	26	51	29,5	32	36	ASV-S-20	33,23
S	420	25	31	56	32,0	41	46	ASV-S-25	51,39
S	420	30	36	62	35,5	46	50	ASV-S-30	63,40
S	420	38	44	69	38,0	55	60	ASV-S-38	84,36

Gerade Anschweißverschraubungen

Straight Welding Bosses

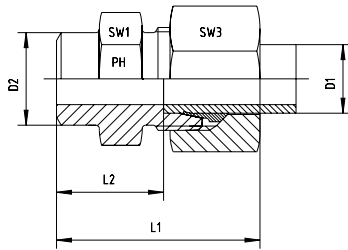

Reihe Series	Druck Pressure PN	Rohr A.D. Tube O.D.		Ca. Maße Approx. Dimensions				Bestellzeichen Order-Code SC	Brutto-Preis Gross-Price Euro (€)
		D1	D2	L1	L2	SW1	SW3		
L	500	6	10	29	14,0	12	14	ASV-L-06-SC	8,50
L	500	8	12	31	16,0	14	17	ASV-L-08-SC	9,46
L	500	10	14	33	18,0	17	19	ASV-L-10-SC	11,33
L	400	12	16	33	18,0	19	27	ASV-L-12-SC	11,83
L	400	15	19	37	22,0	22	27	ASV-L-15-SC	15,27
L	400	18	22	40	23,5	27	32	ASV-L-18-SC	25,06
L	250	22	27	45	28,5	32	36	ASV-L-22-SC	32,95
L	250	28	32	47	30,5	41	41	ASV-L-28-SC	47,51
L	250	35	40	54	32,5	46	50	ASV-L-35-SC	62,52
L	250	42	46	58	35,0	55	60	ASV-L-42-SC	83,57

Reihe Series	Druck Pressure PN	Rohr A.D. Tube O.D.		Ca. Maße Approx. Dimensions				Bestellzeichen Order-Code SC	Brutto-Preis Gross-Price Euro (€)
		D1	D2	L1	L2	SW1	SW3		
S	800	6	11	34	19,0	14	17	ASV-S-06-SC	11,23
S	800	8	13	36	21,0	17	19	ASV-S-08-SC	12,66
S	800	10	15	39	22,5	19	22	ASV-S-10-SC	13,93
S	630	12	17	41	24,5	22	24	ASV-S-12-SC	14,39
S	630	14	19	45	27,0	24	27	ASV-S-14-SC	19,61
S	630	16	21	45	26,5	27	30	ASV-S-16-SC	25,44
S	420	20	26	51	29,5	32	36	ASV-S-20-SC	35,11
S	420	25	31	56	32,0	41	46	ASV-S-25-SC	54,39
S	420	30	36	62	35,5	46	50	ASV-S-30-SC	67,56
S	420	38	44	69	38,0	55	60	ASV-S-38-SC	90,00

Gerade Anschweißverschraubungsstutzen

Straight Welding Boss Bodies



Reihe Series	Druck Pressure PN	Rohr A.D. Tube O.D.		Ca. Maße Approx. Dimensions				Bestellzeichen Order-Code OMD	Brutto-Preis Gross-Price Euro (€)
		D1	D2						
L	500	6	10					ASV-L-06-OMD	5,87
L	500	8	12					ASV-L-08-OMD	6,22
L	500	10	14					ASV-L-10-OMD	7,53
L	400	12	16					ASV-L-12-OMD	7,38
L	400	15	19					ASV-L-15-OMD	9,05
L	400	18	22					ASV-L-18-OMD	14,80
L	250	22	27					ASV-L-22-OMD	20,88
L	250	28	32					ASV-L-28-OMD	30,66
L	250	35	40					ASV-L-35-OMD	37,69
L	250	42	46					ASV-L-42-OMD	51,82

Reihe Series	Druck Pressure PN	Rohr A.D. Tube O.D.		Ca. Maße Approx. Dimensions				Bestellzeichen Order-Code OMD	Brutto-Preis Gross-Price Euro (€)
		D1	D2						
S	800	6	11					ASV-S-06-OMD	8,00
S	800	8	13					ASV-S-08-OMD	9,02
S	800	10	15					ASV-S-10-OMD	9,43
S	630	12	17					ASV-S-12-OMD	9,10
S	630	14	19					ASV-S-14-OMD	12,55
S	630	16	21					ASV-S-16-OMD	15,67
S	420	20	26					ASV-S-20-OMD	22,65
S	420	25	31					ASV-S-25-OMD	32,77
S	420	30	36					ASV-S-30-OMD	39,96
S	420	38	44					ASV-S-38-OMD	52,55



Winkel-Anschweißverschraubungen

Elbow Welding Couplings

Reihe Series	Druck Pressure PN	Rohr A.D. Tube O.D.		Ca. Maße Approx. Dimensions					Bestellzeichen Order-Code Standard	Brutto-Preis Gross-Price Euro (€)
		D1	D2	L1	L2	L3	SW2	SW3		
L	500	6	10	27	12,0	19	12	14	WAS-L-06	16,50
L	500	8	12	29	14,0	23	12	17	WAS-L-08	20,75
L	500	10	14	30	15,0	24	14	19	WAS-L-10	22,70
L	400	12	16	32	17,0	25	17	22	WAS-L-12	25,40
L	400	15	19	36	21,0	30	19	27	WAS-L-15	34,55
L	400	18	22	40	23,5	33	24	32	WAS-L-18	48,45
L	250	22	27	44	27,5	37	27	36	WAS-L-22	65,40
L	250	28	32	47	30,5	42	36	41	WAS-L-28	134,25
L	250	35	40	56	34,5	49	41	50	WAS-L-35	222,45
L	250	42	46	63	40,0	57	50	60	WAS-L-42	295,30

Reihe Series	Druck Pressure PN	Rohr A.D. Tube O.D.		Ca. Maße Approx. Dimensions					Bestellzeichen Order-Code Standard	Brutto-Preis Gross-Price Euro (€)
		D1	D2	L1	L2	L3	SW2	SW3		
S	800	6	11	31	16,0	23	12	17	WAS-S-06	*
S	800	8	13	32	17,0	24	14	19	WAS-S-08	28,00
S	800	10	15	34	17,5	25	17	22	WAS-S-10	28,90
S	630	12	17	38	21,5	29	17	24	WAS-S-12	34,75
S	630	14	19	40	22,0	30	19	27	WAS-S-14	*
S	630	16	21	43	24,5	33	24	30	WAS-S-16	61,10
S	420	20	26	48	26,5	37	27	36	WAS-S-20	68,55
S	420	25	31	54	30,0	42	36	46	WAS-S-25	149,55
S	420	30	36	62	35,5	49	41	50	WAS-S-30	222,45
S	420	38	44	72	41,0	57	50	60	WAS-S-38	306,80



Winkel-Anschweißverschraubungen

Elbow Welding Couplings

Reihe Series	Druck Pressure PN	Rohr A.D. Tube O.D.		Ca. Maße Approx. Dimensions					Bestellzeichen Order-Code SC	Brutto-Preis Gross-Price Euro (€)
		D1	D2	L1	L2	L3	SW2	SW3		
L	500	6	10	27	12,0	19	12	14	WAS-L-06-SC	16,82
L	500	8	12	29	14,0	23	12	17	WAS-L-08-SC	21,19
L	500	10	14	30	15,0	24	14	19	WAS-L-10-SC	23,14
L	400	12	16	32	17,0	25	17	22	WAS-L-12-SC	25,96
L	400	15	19	36	21,0	30	19	27	WAS-L-15-SC	35,63
L	400	18	22	40	23,5	33	24	32	WAS-L-18-SC	50,09
L	250	22	27	44	27,5	37	27	36	WAS-L-22-SC	67,16
L	250	28	32	47	30,5	42	36	41	WAS-L-28-SC	136,25
L	250	35	40	56	34,5	49	41	50	WAS-L-35-SC	226,17
L	250	42	46	63	40,0	57	50	60	WAS-L-42-SC	299,62

Reihe Series	Druck Pressure PN	Rohr A.D. Tube O.D.		Ca. Maße Approx. Dimensions					Bestellzeichen Order-Code SC	Brutto-Preis Gross-Price Euro (€)
		D1	D2	L1	L2	L3	SW2	SW3		
S	800	6	11	31	16,0	23	12	17	WAS-S-06-SC	*
S	800	8	13	32	17,0	24	14	19	WAS-S-08-SC	*
S	800	10	15	34	17,5	25	17	22	WAS-S-10-SC	29,46
S	630	12	17	38	21,5	29	17	24	WAS-S-12-SC	35,59
S	630	14	19	40	22,0	30	19	27	WAS-S-14-SC	*
S	630	16	21	43	24,5	33	24	30	WAS-S-16-SC	62,66
S	420	20	26	48	26,5	37	27	36	WAS-S-20-SC	70,43
S	420	25	31	54	30,0	42	36	46	WAS-S-25-SC	152,55
S	420	30	36	62	35,5	49	41	50	WAS-S-30-SC	226,61
S	420	38	44	72	41,0	57	50	60	WAS-S-38-SC	312,44

Winkel-Anschweißverschraubungsstutzen

Elbow Welding Coupling Bodies



Reihe Series	Druck Pressure PN	Rohr A.D. Tube O.D.		Ca. Maße Approx. Dimensions				Bestellzeichen Order-Code OMD	Brutto-Preis Gross-Price Euro (€)
		D1	D2						
L	500	6	10					WAS-L-06-OMD	14,19
L	500	8	12					WAS-L-08-OMD	17,95
L	500	10	14					WAS-L-10-OMD	19,34
L	400	12	16					WAS-L-12-OMD	21,51
L	400	15	19					WAS-L-15-OMD	29,41
L	400	18	22					WAS-L-18-OMD	39,83
L	250	22	27					WAS-L-22-OMD	55,09
L	250	28	32					WAS-L-28-OMD	119,40
L	250	35	40					WAS-L-35-OMD	201,34
L	250	42	46					WAS-L-42-OMD	267,87

Reihe Series	Druck Pressure PN	Rohr A.D. Tube O.D.		Ca. Maße Approx. Dimensions				Bestellzeichen Order-Code OMD	Brutto-Preis Gross-Price Euro (€)
		D1	D2						
S	800	6	11					WAS-S-06-OMD	*
S	800	8	13					WAS-S-08-OMD	24,80
S	800	10	15					WAS-S-10-OMD	24,96
S	630	12	17					WAS-S-12-OMD	30,30
S	630	14	19					WAS-S-14-OMD	*
S	630	16	21					WAS-S-16-OMD	52,89
S	420	20	26					WAS-S-20-OMD	57,97
S	420	25	31					WAS-S-25-OMD	130,93
S	420	30	36					WAS-S-30-OMD	199,01
S	420	38	44					WAS-S-38-OMD	274,99

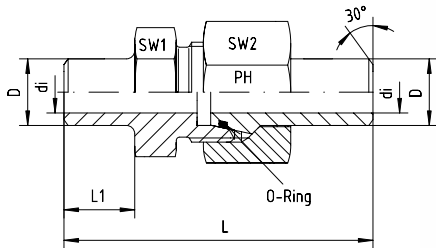

Schweißkegel-Verschraubungen
Mit O-Ring Abdichtung - NBR
Auf Anfrage: Viton

Welding Nipple Couplings
With O-ring Sealing - NBR
On request: Viton

Reihe Series	Druck Pressure PN	Rohr A. D. Tube O. D.	Ca. Maße Approx. Dimensions						O-Ring O-ring	Bestellzeichen Order-Code Standard	Brutto-Preis Gross-Price Euro (€)
			L	L1	D	di	SW1	SW3			
S	528	6 x 1,5	52,5	10,0	6	3	14	17	4,0 x 1,5	ASV-K-6x1,5	16,31
S	414	8 x 1,5	52,5	10,0	8	5	17	19	6,0 x 1,5	ASV-K-8x1,5	18,25
S	528	8 x 2	52,5	10,0	8	4	17	19	6,0 x 1,5	ASV-K-8x2	18,25
S	249	10 x 1	58,0	10,0	10	8	19	22	8,0 x 1,5	ASV-K-10x1	19,61
S	358	10 x 1,5	58,0	10,0	10	7	19	22	8,0 x 1,5	ASV-K-10x1,5	19,61
S	460	10 x 2	58,0	10,0	10	6	19	22	8,0 x 1,5	ASV-K-10x2	19,61
S	305	12 x 1,5	63,0	15,0	12	9	22	24	10,0 x 1,5	ASV-K-12x1,5	20,22
S	393	12 x 2	63,0	15,0	12	8	22	24	10,0 x 1,5	ASV-K-12x2	20,22
S	476	12 x 2,5	63,0	15,0	12	7	22	24	10,0 x 1,5	ASV-K-12x2,5	20,22
S	343	14 x 2	73,0	15,0	14	10	24	27	10,0 x 2,0	ASV-K-14x2	27,61
S	487	14 x 3	73,0	15,0	14	8	24	27	10,0 x 2,0	ASV-K-14x3	27,61
S	305	16 x 2	73,5	16,5	16	12	27	30	13,0 x 2,0	ASV-K-16x2	32,72
S	372	16 x 2,5	73,5	16,5	16	11	27	30	13,0 x 2,0	ASV-K-16x2,5	32,72
S	400	16 x 3	73,5	16,5	16	10	27	30	13,0 x 2,0	ASV-K-16x3	32,72
S	249	20 x 2	83,5	19,0	20	16	32	36	16,0 x 2,0	ASV-K-20x2	44,99
S	305	20 x 2,5	83,5	19,0	20	15	32	36	16,3 x 2,4	ASV-K-20x2,5	44,99
S	358	20 x 3	83,5	19,0	20	14	32	36	16,3 x 2,4	ASV-K-20x3	44,99
S	400	20 x 4	83,5	19,0	20	12	32	36	16,3 x 2,4	ASV-K-20x4	44,99
S	294	25 x 3	92,5	19,5	25	19	41	46	21,3 x 2,4	ASV-K-25x3	72,14
S	379	25 x 4	92,5	19,5	25	17	41	46	21,3 x 2,4	ASV-K-25x4	72,14
S	400	25 x 5	92,5	19,5	25	15	41	46	21,3 x 2,4	ASV-K-25x5	72,14
S	249	30 x 3	101,5	23,0	30	24	46	50	25,3 x 2,4	ASV-K-30x3	89,99
S	323	30 x 4	101,5	23,0	30	22	46	50	25,3 x 2,4	ASV-K-30x4	89,99
S	393	30 x 5	101,5	23,0	30	20	46	50	25,3 x 2,4	ASV-K-30x5	89,99
S	400	30 x 6	101,5	23,0	30	18	46	50	25,3 x 2,4	ASV-K-30x6	89,99
S	261	38 x 4	108,0	22,0	38	30	55	60	34,0 x 2,5	ASV-K-38x4	102,26
S	315	38 x 5	108,0	22,0	38	28	55	60	34,0 x 2,5	ASV-K-38x5	102,26
S	315	38 x 6	108,0	22,0	38	26	55	60	34,0 x 2,5	ASV-K-38x6	102,26
S	315	38 x 7	108,0	22,0	38	24	55	60	34,0 x 2,5	ASV-K-38x7	102,26
S	250	50 x 5	118,0	23,0	50	40	70	80	46,0 x 3,0	ASV-K-50x5	417,00
S	310	50 x 6	118,0	23,0	50	38	70	80	46,0 x 3,0	ASV-K-50x6	417,00
S	350	50 x 7	118,0	23,0	50	36	70	80	46,0 x 3,0	ASV-K-50x7	417,00

Reihe Series	Druck Pressure PN	Rohr A. D. Tube O. D.	Ca. Maße Approx. Dimensions						O-Ring O-ring	Bestellzeichen Order-Code Standard	Brutto-Preis Gross-Price Euro (€)
			L	L1	D	di	SW1	SW3			
L	323	15 x 2	54,5	15,0	15	11	22	27	12,0 x 2,0	ASV-K-15x2	31,72
L	315	18 x 2	57,5	16,0	18	14	27	32	15,0 x 2,0	ASV-K-18x2	34,22
L	280	22 x 2,5	74,0	19,0	22	17	32	36	19,0 x 2,0	ASV-K-22x2,5	47,99
L	265	28 x 3	78,0	19,0	28	22	41	41	25,0 x 2,0	ASV-K-28x3	73,14
L	231	35 x 3	87,5	22,0	35	29	46	50	32,0 x 2,5	ASV-K-35x3	90,49
L	182	42 x 3	87,0	22,0	42	36	55	60	38,0 x 2,5	ASV-K-42x3	102,26

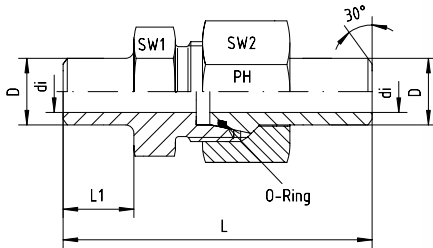

Schweißkegel-Verschraubungen
Mit O-Ring Abdichtung - NBR
Auf Anfrage: Viton

Welding Nipple Couplings
With O-ring Sealing - NBR
On request: Viton

Reihe Series	Druck Pressure PN	Rohr A. D. Tube O. D.	Ca. Maße Approx. Dimensions						O-Ring O-ring	Bestellzeichen Order-Code SC	Brutto-Preis Gross-Price Euro (€)
			L	L1	D	di	SW1	SW3			
S	528	6 x 1,5			6	3	14	17	4,0 x 1,5	ASV-K-6x1,5-SC	16,75
S	414	8 x 1,5			8	5	17	19	6,0 x 1,5	ASV-K-8x1,5-SC	18,69
S	528	8 x 2			8	4	17	19	6,0 x 1,5	ASV-K-8x2-SC	18,69
S	249	10 x 1	58,0	10,0	10	8	19	22	8,0 x 1,5	ASV-K-10x1-SC	20,17
S	358	10 x 1,5	58,0	10,0	10	7	19	22	8,0 x 1,5	ASV-K-10x1,5-SC	20,17
S	460	10 x 2	58,0	10,0	10	6	19	22	8,0 x 1,5	ASV-K-10x2-SC	20,17
S	305	12 x 1,5	63,0	15,0	12	9	22	24	10,0 x 1,5	ASV-K-12x1,5-SC	21,06
S	393	12 x 2	63,0	15,0	12	8	22	24	10,0 x 1,5	ASV-K-12x2-SC	21,06
S	476	12 x 2,5	63,0	15,0	12	7	22	24	10,0 x 1,5	ASV-K-12x2,5-SC	21,06
S	343	14 x 2			14	10	24	27	10,0 x 2,0	ASV-K-14x2-SC	29,17
S	487	14 x 3			14	8	24	27	10,0 x 2,0	ASV-K-14x3-SC	29,17
S	305	16 x 2	73,5	16,5	16	12	27	30	13,0 x 2,0	ASV-K-16x2-SC	34,28
S	372	16 x 2,5	73,5	16,5	16	11	27	30	13,0 x 2,0	ASV-K-16x2,5-SC	34,28
S	400	16 x 3	73,5	16,5	16	10	27	30	13,0 x 2,0	ASV-K-16x3-SC	34,28
S	249	20 x 2	83,5	19,0	20	16	32	36	16,0 x 2,0	ASV-K-20x2-SC	46,87
S	305	20 x 2,5	83,5	19,0	20	15	32	36	16,3 x 2,4	ASV-K-20x2,5-SC	46,87
S	358	20 x 3	83,5	19,0	20	14	32	36	16,3 x 2,4	ASV-K-20x3-SC	46,87
S	400	20 x 4	83,5	19,0	20	12	32	36	16,3 x 2,4	ASV-K-20x4-SC	46,87
S	294	25 x 3	92,5	19,5	25	19	41	46	21,3 x 2,4	ASV-K-25x3-SC	75,14
S	379	25 x 4	92,5	19,5	25	17	41	46	21,3 x 2,4	ASV-K-25x4-SC	75,14
S	400	25 x 5	92,5	19,5	25	15	41	46	21,3 x 2,4	ASV-K-25x5-SC	75,14
S	249	30 x 3	101,5	23,0	30	24	46	50	25,3 x 2,4	ASV-K-30x3-SC	94,15
S	323	30 x 4	101,5	23,0	30	22	46	50	25,3 x 2,4	ASV-K-30x4-SC	94,15
S	393	30 x 5	101,5	23,0	30	20	46	50	25,3 x 2,4	ASV-K-30x5-SC	94,15
S	400	30 x 6	101,5	23,0	30	18	46	50	25,3 x 2,4	ASV-K-30x6-SC	94,15
S	261	38 x 4	108,0	22,0	38	30	55	60	34,0 x 2,5	ASV-K-38x4-SC	107,90
S	315	38 x 5	108,0	22,0	38	28	55	60	34,0 x 2,5	ASV-K-38x5-SC	107,90
S	315	38 x 6	108,0	22,0	38	26	55	60	34,0 x 2,5	ASV-K-38x6-SC	107,90
S	315	38 x 7	108,0	22,0	38	24	55	60	34,0 x 2,5	ASV-K-38x7-SC	107,90
S	250	50 x 5	118,0	23,0	50	40	70	80	46,0 x 3,0	ASV-K-50x5-SC	*
S	310	50 x 6	118,0	23,0	50	38	70	80	46,0 x 3,0	ASV-K-50x6-SC	*
S	350	50 x 7	118,0	23,0	50	36	70	80	46,0 x 3,0	ASV-K-50x7-SC	*

Reihe Series	Druck Pressure PN	Rohr A. D. Tube O. D.	Ca. Maße Approx. Dimensions						O-Ring O-ring	Bestellzeichen Order-Code SC	Brutto-Preis Gross-Price Euro (€)
			L	L1	D	di	SW1	SW3			
L	323	15 x 2	54,5	15,0	15	11	22	27	12,0 x 2,0	ASV-K-15x2-SC	33,28
L	315	18 x 2	57,5	16,0	18	14	27	32	15,0 x 2,0	ASV-K-18x2-SC	35,78
L	280	22 x 2,5	74,0	19,0	22	17	32	36	19,0 x 2,0	ASV-K-22x2,5-SC	49,87
L	265	28 x 3	78,0	19,0	28	22	41	41	25,0 x 2,0	ASV-K-28x3-SC	76,14
L	231	35 x 3	87,5	22,0	35	29	46	50	32,0 x 2,5	ASV-K-35x3-SC	94,65
L	182	42 x 3	87,0	22,0	42	36	55	60	38,0 x 2,5	ASV-K-42x3-SC	107,90



Schweißkegel-Verschraubungsstutzen
Mit O-Ring Abdichtung - NBR
Auf Anfrage: Viton

Welding Nipple Coupling Bodies
With O-ring Sealing - NBR
On request: Viton

Reihe Series	Druck Pressure PN	Rohr A. D. Tube O. D.	Ca. Maße Approx. Dimensions				O-Ring O-ring	Bestellzeichen Order-Code OMD	Brutto-Preis Gross-Price Euro (€)
S	528	6 x 1,5					4,0 x 1,5	ASV-K-6x1,5-OMD	8,74
S	414	8 x 1,5					6,0 x 1,5	ASV-K-8x1,5-OMD	9,02
S	528	8 x 2					6,0 x 1,5	ASV-K-8x2-OMD	9,02
S	249	10 x 1					8,0 x 1,5	ASV-K-10x1-OMD	9,43
S	358	10 x 1,5					8,0 x 1,5	ASV-K-10x1,5-OMD	9,43
S	460	10 x 2					8,0 x 1,5	ASV-K-10x2-OMD	9,43
S	305	12 x 1,5					10,0 x 1,5	ASV-K-12x1,5-OMD	8,92
S	393	12 x 2					10,0 x 1,5	ASV-K-12x2-OMD	8,92
S	476	12 x 2,5					10,0 x 1,5	ASV-K-12x2,5-OMD	8,92
S	343	14 x 2					10,0 x 2,0	ASV-K-14x2-OMD	14,21
S	487	14 x 3					10,0 x 2,0	ASV-K-14x3-OMD	14,21
S	305	16 x 2					13,0 x 2,0	ASV-K-16x2-OMD	14,90
S	372	16 x 2,5					13,0 x 2,0	ASV-K-16x2,5-OMD	14,90
S	400	16 x 3					13,0 x 2,0	ASV-K-16x3-OMD	14,90
S	249	20 x 2					16,0 x 2,0	ASV-K-20x2-OMD	22,16
S	305	20 x 2,5					16,3 x 2,4	ASV-K-20x2,5-OMD	22,16
S	358	20 x 3					16,3 x 2,4	ASV-K-20x3-OMD	22,16
S	400	20 x 4					16,3 x 2,4	ASV-K-20x4-OMD	22,16
S	294	25 x 3					21,3 x 2,4	ASV-K-25x3-OMD	35,73
S	379	25 x 4					21,3 x 2,4	ASV-K-25x4-OMD	35,73
S	400	25 x 5					21,3 x 2,4	ASV-K-25x5-OMD	35,73
S	249	30 x 3					25,3 x 2,4	ASV-K-30x3-OMD	44,51
S	323	30 x 4					25,3 x 2,4	ASV-K-30x4-OMD	44,51
S	393	30 x 5					25,3 x 2,4	ASV-K-30x5-OMD	44,51
S	400	30 x 6					25,3 x 2,4	ASV-K-30x6-OMD	44,51
S	261	38 x 4					34,0 x 2,5	ASV-K-38x4-OMD	39,37
S	315	38 x 5					34,0 x 2,5	ASV-K-38x5-OMD	39,37
S	315	38 x 6					34,0 x 2,5	ASV-K-38x6-OMD	39,37
S	315	38 x 7					34,0 x 2,5	ASV-K-38x7-OMD	39,37
S	250	50 x 5					46,0 x 3,0	ASV-K-50x5-OMD	229,00
S	310	50 x 6					46,0 x 3,0	ASV-K-50x6-OMD	229,00
S	350	50 x 7					46,0 x 3,0	ASV-K-50x7-OMD	229,00

Reihe Series	Druck Pressure PN	Rohr A. D. Tube O. D.	Ca. Maße Approx. Dimensions				O-Ring O-ring	Bestellzeichen Order-Code OMD	Brutto-Preis Gross-Price Euro (€)
L	323	15 x 2					12,0 x 2,0	ASV-K-15x2-OMD	13,90
L	315	18 x 2					15,0 x 2,0	ASV-K-18x2-OMD	16,40
L	280	22 x 2,5					19,0 x 2,0	ASV-K-22x2,5-OMD	25,16
L	265	28 x 3					25,0 x 2,0	ASV-K-28x3-OMD	36,73
L	231	35 x 3					32,0 x 2,5	ASV-K-35x3-OMD	45,01
L	182	42 x 3					38,0 x 2,5	ASV-K-42x3-OMD	39,37

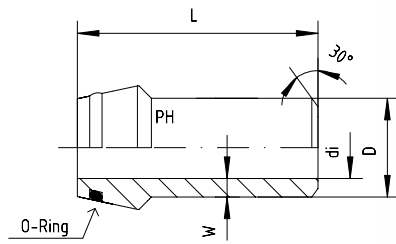

Mit O-Ring Abdichtung - NBR
Auf Anfrage: Viton
Passend in 24°-Innenkonus
Bohrungsform W DIN 3861

With O-ring Sealing - NBR
On request: Viton
Matching Type 24°-Inside Tapers
Bore Type W DIN 3861

Reihe Series	Druck Pressure PN	D x W	Ca. Maße Approx. Dimensions		O-Ring O-ring	Bestellzeichen Order-Code	Brutto-Preis Gross-Price Euro (€)
			di	L			
L + S	528	6 x 1,5	3	31,0	4,0 x 1,5	SKV-6x1,5	5,37
L + S	414	8 x 1,5	5	31,0	6,0 x 1,5	SKV-8x1,5	6,72
L + S	528	8 x 2	4	31,0	6,0 x 1,5	SKV-8x2	6,72
L + S	249	10 x 1	8	32,5	8,0 x 1,5	SKV-10x1	7,21
L + S	358	10 x 1,5	7	32,5	8,0 x 1,5	SKV-10x1,5	7,21
L + S	460	10 x 2	6	32,5	8,0 x 1,5	SKV-10x2	7,21
L + S	305	12 x 1,5	9	32,5	10,0 x 1,5	SKV-12x1,5	7,95
L + S	393	12 x 2	8	32,5	10,0 x 1,5	SKV-12x2	7,95
L + S	476	12 x 2,5	7	32,5	10,0 x 1,5	SKV-12x2,5	7,95
L + S	476	12 x 3	6	32,5	10,0 x 1,5	SKV-12x3	7,95
S	343	14 x 2	10	40,0	10,0 x 2,0	SKV-14x2	9,23
S	415	14 x 2,5	9	40,0	10,0 x 2,0	SKV-14x2,5	9,23
S	487	14 x 3	8	40,0	10,0 x 2,0	SKV-14x3	9,23
L	270	15 x 1,5	12	36,0	12,0 x 2,0	SKV-15x1,5	10,33
L	323	15 x 2	11	36,0	12,0 x 2,0	SKV-15x2	10,33
L	393	15 x 2,5	10	36,0	12,0 x 2,0	SKV-15x2,5	10,33
S	305	16 x 2	12	38,5	13,0 x 2,0	SKV-16x2	10,99
S	372	16 x 2,5	11	38,5	13,0 x 2,0	SKV-16x2,5	10,99
S	435	16 x 3	10	38,5	13,0 x 2,0	SKV-16x3	10,99
L	225	18 x 1,5	15	37,0	16,0 x 1,5	SKV-18x1,5	12,71
L	300	18 x 2	14	37,0	15,0 x 2,0	SKV-18x2	12,71
L	335	18 x 2,5	13	37,0	15,0 x 2,0	SKV-18x2,5	12,71
S	249	20 x 2	16	44,5	16,0 x 2,0	SKV-20x2	13,86
S	305	20 x 2,5	15	44,5	16,3 x 2,4	SKV-20x2,5	13,86
S	358	20 x 3	14	44,5	16,3 x 2,4	SKV-20x3	13,86
S	460	20 x 4	12	44,5	16,3 x 2,4	SKV-20x4	13,86
L	245	22 x 2	18	38,5	19,0 x 2,0	SKV-22x2	15,47
L	280	22 x 2,5	17	38,5	19,0 x 2,0	SKV-22x2,5	15,47
L	328	22 x 3	16	38,5	19,0 x 2,0	SKV-22x3	15,47
S	294	25 x 3	19	49,5	21,3 x 2,4	SKV-25x3	20,30
S	337	25 x 3,5	18	49,5	21,3 x 2,4	SKV-25x3,5	20,30
S	379	25 x 4	17	49,5	21,3 x 2,4	SKV-25x4	20,30
S	460	25 x 5	15	49,5	21,3 x 2,4	SKV-25x5	20,30
L	193	28 x 2	24	41,5	25,0 x 2,0	SKV-28x2	23,57
L	224	28 x 2,5	23	41,5	25,0 x 2,0	SKV-28x2,5	23,57
L	265	28 x 3	22	41,5	25,0 x 2,0	SKV-28x3	23,57
S	249	30 x 3	27	52,0	25,3 x 2,4	SKV-30x3	25,67
S	323	30 x 4	22	52,0	25,3 x 2,4	SKV-30x4	25,67
S	393	30 x 5	20	52,0	25,3 x 2,4	SKV-30x5	25,67
S	460	30 x 6	18	52,0	25,3 x 2,4	SKV-30x6	25,67
L	154	35 x 2	31	47,0	32,0 x 2,5	SKV-35x2	27,76
L	193	35 x 2,5	30	47,0	32,0 x 2,5	SKV-35x2,5	27,76
L	231	35 x 3	29	47,0	32,0 x 2,5	SKV-35x3	27,76
L	249	35 x 3,5	28	47,0	32,0 x 2,5	SKV-35x3,5	27,76
S	261	38 x 4	30	56,5	34,0 x 2,5	SKV-38x4	34,97
S	319	38 x 5	28	56,5	34,0 x 2,5	SKV-38x5	34,97
S	375	38 x 6	26	56,5	34,0 x 2,5	SKV-38x6	34,97
S	429	38 x 7	24	56,5	39,0 x 1,5	SKV-38x7	34,97
L	129	42 x 2	38	47,0	39,0 x 1,5	SKV-42x2	37,22
L	150	42 x 2,5	37	47,0	38,0 x 2,5	SKV-42x2,5	37,22
L	182	42 x 3	36	47,0	38,0 x 2,5	SKV-42x3	37,22
L	238	42 x 4	34	47,0	38,0 x 2,5	SKV-42x4	*
S	250	50 x 5	40	61,0	46,0 x 3,0	SKV-50x5	89,00
S	310	50 x 6	38	61,0	46,0 x 3,0	SKV-50x6	*
S	350	50 x 7	36	61,0	46,0 x 3,0	SKV-50x7	89,00

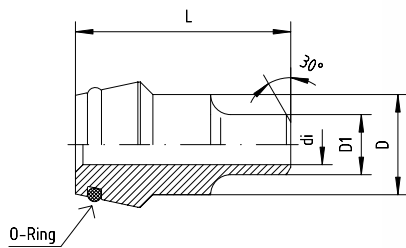

Mit O-Ring Abdichtung - NBR
Auf Anfrage: Viton
Passend in 24°-Innenkonus
Bohrungsform W DIN 3861

With O-ring Sealing - NBR
On request: Viton
Matching Type 24°-Inside Tapers
Bore Type W DIN 3861

Reihe Series	Druck Pressure PN	Ca. Maße Approx. Dimensions				O-Ring O-ring	Bestellzeichen Order-Code	Brutto-Preis Gross-Price Euro (€)
		D	D1	di	L			
S	380	8	6	4	30	6,0 x 1,5	SKV-R-8/6x1	*
S	528	8	6	3	30	6,0 x 1,5	SKV-R-8/6x1,5	10,05
S	414	10	8	5	32	8,0 x 1,5	SKV-R-10/8x1,5	10,05
S	528	10	8	4	32	8,0 x 1,5	SKV-R-10/8x2	10,05
S	528	10	6	3	32	8,0 x 1,5	SKV-R-10/6x1,5	10,05
S	358	12	10	7	32	10,0 x 1,5	SKV-R-12/10x1,5	10,55
S	460	12	10	6	32	10,0 x 1,5	SKV-R-12/10x2	10,55
S	414	12	8	5	32	10,0 x 1,5	SKV-R-12/8x1,5	10,55
S	380	12	6	4	32	10,0 x 1,5	SKV-R-12/6x1	*
S	528	12	6	3	32	10,0 x 1,5	SKV-R-12/6x1,5	*
S	393	16	12	8	39	13,0 x 2,0	SKV-R-16/12x2	12,40
S	460	16	10	6	39	13,0 x 2,0	SKV-R-16/10x2	12,40
S	414	16	8	5	39	13,0 x 2,0	SKV-R-16/8x1,5	12,40
S	435	20	16	10	43	16,3 x 2,4	SKV-R-20/16x3	15,20
S	372	20	16	11	43	16,3 x 2,4	SKV-R-20/16x2,5	15,20
S	305	20	16	12	43	16,3 x 2,4	SKV-R-20/16x2	15,20
S	393	20	12	8	43	16,3 x 2,4	SKV-R-20/12x2	15,20
S	358	20	10	7	43	16,3 x 2,4	SKV-R-20/10x1,5	15,20
S	414	20	8	5	43	16,3 x 2,4	SKV-R-20/8x1,5	16,50
S	358	25	20	14	50	21,3 x 2,4	SKV-R-25/20x3	21,60
S	305	25	20	15	50	21,3 x 2,4	SKV-R-25/20x2,5	21,60
S	249	25	20	16	50	21,3 x 2,4	SKV-R-25/20x2	21,60
S	435	25	16	10	50	21,3 x 2,4	SKV-R-25/16x3	21,60
S	372	25	16	11	50	21,3 x 2,4	SKV-R-25/16x2,5	21,60
S	305	25	16	12	50	21,3 x 2,4	SKV-R-25/16x2	21,60
S	393	25	12	8	50	21,3 x 2,4	SKV-R-25/12x2	21,60
S	460	25	10	6	50	21,3 x 2,4	SKV-R-25/10x2	23,90
S	294	30	25	19	52	25,3 x 2,4	SKV-R-30/25x3	38,00
S	358	30	20	14	52	25,3 x 2,4	SKV-R-30/20x3	38,00
S	435	30	16	10	52	25,3 x 2,4	SKV-R-30/16x3	38,00
S	393	30	12	8	52	25,3 x 2,4	SKV-R-30/12x2	39,90
S	323	38	30	22	58	34,0 x 2,5	SKV-R-38/30x4	49,60
S	249	38	30	24	58	34,0 x 2,5	SKV-R-38/30x3	49,60
S	379	38	25	17	58	34,0 x 2,5	SKV-R-38/25x4	49,60
S	294	38	25	19	58	34,0 x 2,5	SKV-R-38/25x3	49,60
S	358	38	20	14	58	34,0 x 2,5	SKV-R-38/20x3	49,60
S	305	38	20	15	58	34,0 x 2,5	SKV-R-38/20x2,5	49,60
S	435	38	16	10	58	34,0 x 2,5	SKV-R-38/16x3	49,60
S	305	38	16	12	58	34,0 x 2,5	SKV-R-38/16x2	49,60
S	393	38	12	8	58	34,0 x 2,5	SKV-R-38/12x2	56,80

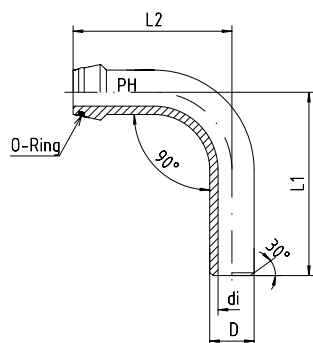

Mit O-Ring Abdichtung - NBR
Auf Anfrage: Viton
Passend in 24°-Innenkonus
Bohrungsform W DIN 3861

With O-ring Sealing - NBR
On request: Viton
Matching Type 24°-Inside Tapers
Bore Type W DIN 3861

Reihe Series	Druck Pressure PN	Rohr Tube	Ca. Maße Approx. Dimensions				O-Ring O-ring	Bestellzeichen Order-Code	Brutto-Preis Gross-Price Euro (€)
			D	di	L1	L2			
S	460	10 x 2	10	6	49	51	8,0 x 1,5	SKV-RB-10x2	37,85
S	393	12 x 2	12	8	50	51	10,0 x 1,5	SKV-RB-12x2	42,55
S	476	12 x 2,5	12	7	50	51	10,0 x 1,5	SKV-RB-12x2,5	42,55
S	305	16 x 2	16	12	72	67	13,0 x 2,0	SKV-RB-16x2	50,75
S	372	16 x 2,5	16	11	72	67	13,0 x 2,0	SKV-RB-16x2,5	50,75
S	435	16 x 3	16	10	72	67	13,0 x 2,0	SKV-RB-16x3	50,75
S	249	20 x 2	20	16	89	86	16,3 x 2,4	SKV-RB-20x2	60,20
S	305	20 x 2,5	20	15	89	86	16,3 x 2,4	SKV-RB-20x2,5	60,20
S	358	20 x 3	20	14	89	86	16,3 x 2,4	SKV-RB-20x3	60,20
L	328	22 x 3	22	16	79	85	19,0 x 2,0	SKV-RB-22x3	70,55
S	294	25 x 3	25	19	93	89	21,3 x 2,4	SKV-RB-25x3	70,55
S	379	25 x 4	25	17	93	89	21,3 x 2,4	SKV-RB-25x4	70,55
S	460	25 x 5	25	15	93	89	21,3 x 2,4	SKV-RB-25x5	70,55
S	323	30 x 4	30	22	112	105	25,3 x 2,4	SKV-RB-30x4	102,90
S	393	30 x 5	30	20	112	105	25,3 x 2,4	SKV-RB-30x5	102,90
S	460	30 x 6	30	18	112	105	25,3 x 2,4	SKV-RB-30x6	102,90
S	261	38 x 4	38	30	145	137	34,0 x 2,5	SKV-RB-38x4	130,60
S	319	38 x 5	38	28	145	137	34,0 x 2,5	SKV-RB-38x5	130,60
S	375	38 x 6	38	26	145	137	34,0 x 2,5	SKV-RB-38x6	130,60
S	429	38 x 7	38	24	145	137	34,0 x 2,5	SKV-RB-38x7	*





Winkel-Drehverschraubungen Elbow Rotary Couplings





WINKEL-DREHVERSCHRAUBUNGEN ELBOW ROTARY COUPLINGS

Produktgruppen	Product Groups	Seite Page
Anwendung	<i>Application</i>	11.2
 Drehverschraubungen	<i>Rotary Couplings</i>	
- Drehverschraubungen - Standard	- <i>Rotary Couplings - Standard</i>	11.3
- Drehverschraubungen - SC	- <i>Rotary Couplings - SC</i>	11.4
- Drehverschraubungen - OMD	- <i>Rotary Couplings - OMD</i>	11.5

Standard = Überwurfmutter blank / Tube nuts are supplied unplated
SC = Überwurfmutter bis Größe 12-S ist gleitbeschichtet / Tube nuts until size 12-L are supplied chemical plated
= Überwurfmutter ab Größe 12-S ist mit versilbertem Gewinde / Tube nuts from size 12-S are supplied with silver plated thread
OMD = Verschraubung ohne Überwurfmutter und Schneidring am Außengewinde / Couplings are supplied without nut and cutting ring at male thread

Drehverschraubungen sind Verbindungselemente für die Übertragung von Schwenk- und Drehbewegungen mit geringer Winkelgeschwindigkeit zwischen Aggregaten und Leitungen. Die Verbindungen sind wartungsfrei, ohne Leckverluste und haben niedrige Anlaufdrehmomente.

Hinweis:

Zum Ausgleich jeder Fluchtungsungenauigkeit wird die Verwendung eines flexiblen Anschlusses dringend empfohlen. Die Lebensdauer der Dichtelemente ist abhängig vom Betriebsdruck, der Gleitgeschwindigkeit und dem Medium.

Die Drehverschraubungen sind nur für schmierende Medien geeignet.

Temperatur -15°C bis $+100^{\circ}\text{C}$.

Andere Anschlussarten und Dichtungskombinationen auf Anfrage.

Swivel banjos are designed to connect rigid tube to equipment for transmission of swivelling movement and rotation at low angular velocity. These couplings have a low starting torque, are leak free and require no maintenance.

Note:

To compensate any misalignment, the use of a flexible connection is recommended. Life of the sealing elements is dependent upon operating pressure, turning speed and medium.

These rotary couplings are only usable for lubricating media.

Temperature: -15°C to $+100^{\circ}\text{C}$

Other connections and sealing combinations on request.

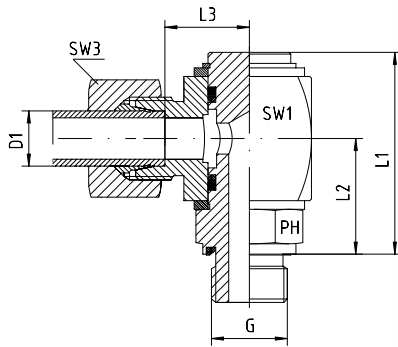

Winkel-Drehverschraubungen

Einschraubgewinde G: Whitworth-Rohrgewinde - Zylindrisch

Ausführung: Gehäuse aus Vierkantstahl

Dichtungskombination:

- O-Ring + wd = Viton / FPM
- Stützring = PTFE

Elbow Rotary Couplings

Thread G: BSP - Parallel

Construction: Bodies made from Steel Bar

Sealing Combination:

- O-ring + wd-Sealing = Viton / FPM
- Backing Ring = PTFE

Reihe Series	Druck Pressure PB	Rohr A.D. Tube O.D.		Ca. Maße Approx. Dimensions					Bestellzeichen Order-Code Standard	Brutto-Preis Gross-Price Euro (€)
		D1	G	L1	L2	L3	SW1	SW3		
L	250	6	1/8"	47,0	26,5	16,5	27	14	DGWE-L-06-G 1/8"-wd	256,00
L	250	6	1/4"	47,5	26,5	16,5	27	14	DGWE-L-06-G 1/4"-wd	256,00
L	250	6	3/8"	47,5	26,5	16,5	27	14	DGWE-L-06-G 3/8"-wd	300,00
L	250	8	1/4"	47,5	26,5	16,5	27	17	DGWE-L-08-G 1/4"-wd	256,00
L	250	8	3/8"	47,5	26,5	16,5	27	17	DGWE-L-08-G 3/8"-wd	300,00
L	250	10	1/4"	47,5	26,5	17,5	27	19	DGWE-L-10-G 1/4"-wd	256,00
L	250	10	3/8"	47,5	26,5	17,5	27	19	DGWE-L-10-G 3/8"-wd	300,00
L	250	12	1/4"	47,5	26,5	17,5	27	22	DGWE-L-12-G 1/4"-wd	256,00
L	250	12	3/8"	47,5	26,5	17,5	27	22	DGWE-L-12-G 3/8"-wd	300,00
L	250	12	1/2"	58,5	33,5	23,0	36	22	DGWE-L-12-G 1/2"-wd	340,00
L	250	15	1/2"	58,5	33,5	24,0	36	27	DGWE-L-15-G 1/2"-wd	340,00
L	160	18	1/2"	58,5	33,5	23,5	36	32	DGWE-L-18-G 1/2"-wd	340,00
L	160	22	3/4"	66,0	38,0	27,5	41	36	DGWE-L-22-G 3/4"-wd	384,00
L	100	28	1"	72,0	42,5	29,5	46	41	DGWE-L-28-G 1"-wd	436,00
L	100	35	1 1/4"					50	DGWE-L-35-G 1 1/4"-wd	825,00
L	100	42	1 1/2"					60	DGWE-L-42-G 1 1/2"-wd	949,00

Reihe Series	Druck Pressure PB	Rohr A.D. Tube O.D.		Ca. Maße Approx. Dimensions					Bestellzeichen Order-Code Standard	Brutto-Preis Gross-Price Euro (€)
		D1	G	L1	L2	L3	SW1	SW3		
S	400	6	1/4"	47,5	26,5	18,5	27	17	DGWE-S-06-G 1/4"-wd	256,00
S	400	6	3/8"	47,5	26,5	18,5	27	17	DGWE-S-06-G 3/8"-wd	300,00
S	400	8	1/4"	47,5	26,5	18,5	27	19	DGWE-S-08-G 1/4"-wd	256,00
S	400	8	3/8"	47,5	26,5	18,5	27	19	DGWE-S-08-G 3/8"-wd	300,00
S	400	10	1/4"	47,5	26,5	18,0	27	22	DGWE-S-10-G 1/4"-wd	300,00
S	400	10	3/8"	47,5	26,5	18,0	27	22	DGWE-S-10-G 3/8"-wd	300,00
S	400	12	3/8"	47,5	26,5	18,0	27	24	DGWE-S-12-G 3/8"-wd	300,00
S	400	14	1/2"	58,5	33,5	25,0	36	27	DGWE-S-14-G 1/2"-wd	340,00
S	400	16	1/2"	58,5	33,5	24,5	36	30	DGWE-S-16-G 1/2"-wd	340,00
S	250	20	3/4"	66,0	38,0	26,5	41	36	DGWE-S-20-G 3/4"-wd	384,00
S	250	25	1"	72,0	42,5	29,0	46	46	DGWE-S-25-G 1"-wd	436,00
S	250	30	1 1/4"					50	DGWE-S-30-G 1 1/4"-wd	825,00
S	250	38	1 1/2"					60	DGWE-S-38-G 1 1/2"-wd	984,00

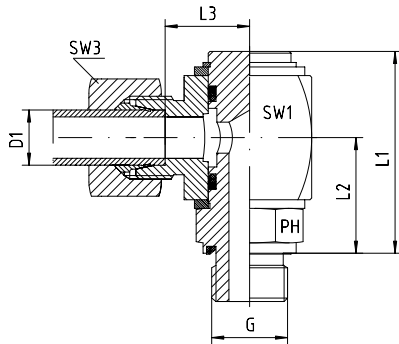

Winkel-Drehverschraubungen

Einschraubgewinde G: Whitworth-Rohrgewinde - Zylindrisch

Ausführung: Gehäuse aus Vierkantstahl

Dichtungskombination:

- O-Ring + wd = Viton / FPM
- Stützring = PTFE

Elbow Rotary Couplings

Thread G: BSP - Parallel

Construction: Bodies made from Steel Bar

Sealing Combination:

- O-ring + wd-Sealing = Viton / FPM
- Backing Ring = PTFE

Reihe Series	Druck Pressure PB	Rohr A.D. Tube O.D.		Ca. Maße Approx. Dimensions					Bestellzeichen Order-Code SC	Brutto-Preis Gross-Price Euro (€)
		D1	G	L1	L2	L3	SW1	SW3		
L	250	6	1/8"	47,0	26,5	16,5	27	14	DGWE-L-06-G 1/8"-wd-SC	256,32
L	250	6	1/4"	47,5	26,5	16,5	27	14	DGWE-L-06-G 1/4"-wd-SC	256,32
L	250	6	3/8"	47,5	26,5	16,5	27	14	DGWE-L-06-G 3/8"-wd-SC	300,32
L	250	8	1/4"	47,5	26,5	16,5	27	17	DGWE-L-08-G 1/4"-wd-SC	256,44
L	250	8	3/8"	47,5	26,5	16,5	27	17	DGWE-L-08-G 3/8"-wd-SC	300,44
L	250	10	1/4"	47,5	26,5	17,5	27	19	DGWE-L-10-G 1/4"-wd-SC	256,44
L	250	10	3/8"	47,5	26,5	17,5	27	19	DGWE-L-10-G 3/8"-wd-SC	300,44
L	250	12	1/4"	47,5	26,5	17,5	27	22	DGWE-L-12-G 1/4"-wd-SC	256,56
L	250	12	3/8"	47,5	26,5	17,5	27	22	DGWE-L-12-G 3/8"-wd-SC	300,56
L	250	12	1/2"	58,5	33,5	23,0	36	22	DGWE-L-12-G 1/2"-wd-SC	340,56
L	250	15	1/2"	58,5	33,5	24,0	36	27	DGWE-L-15-G 1/2"-wd-SC	341,08
L	160	18	1/2"	58,5	33,5	23,5	36	32	DGWE-L-18-G 1/2"-wd-SC	341,64
L	160	22	3/4"	66,0	38,0	27,5	41	36	DGWE-L-22-G 3/4"-wd-SC	385,76
L	100	28	1"	72,0	42,5	29,5	46	41	DGWE-L-28-G 1"-wd-SC	438,00
L	100	35	1 1/4"					50	DGWE-L-35-G 1 1/4"-wd-SC	*
L	100	42	1 1/2"					60	DGWE-L-42-G 1 1/2"-wd-SC	*

Reihe Series	Druck Pressure PB	Rohr A.D. Tube O.D.		Ca. Maße Approx. Dimensions					Bestellzeichen Order-Code SC	Brutto-Preis Gross-Price Euro (€)
		D1	G	L1	L2	L3	SW1	SW3		
S	400	6	1/4"	47,5	26,5	18,5	27	17	DGWE-S-06-G 1/4"-wd-SC	256,44
S	400	6	3/8"	47,5	26,5	18,5	27	17	DGWE-S-06-G 3/8"-wd-SC	300,44
S	400	8	1/4"	47,5	26,5	18,5	27	19	DGWE-S-08-G 1/4"-wd-SC	256,44
S	400	8	3/8"	47,5	26,5	18,5	27	19	DGWE-S-08-G 3/8"-wd-SC	300,44
S	400	10	1/4"	47,5	26,5	18,0	27	22	DGWE-S-10-G 1/4"-wd-SC	300,56
S	400	10	3/8"	47,5	26,5	18,0	27	22	DGWE-S-10-G 3/8"-wd-SC	300,56
S	400	12	3/8"	47,5	26,5	18,0	27	24	DGWE-S-12-G 3/8"-wd-SC	300,84
S	400	14	1/2"	58,5	33,5	25,0	36	27	DGWE-S-14-G 1/2"-wd-SC	341,56
S	400	16	1/2"	58,5	33,5	24,5	36	30	DGWE-S-16-G 1/2"-wd-SC	341,56
S	250	20	3/4"	66,0	38,0	26,5	41	36	DGWE-S-20-G 3/4"-wd-SC	385,88
S	250	25	1"	72,0	42,5	29,0	46	46	DGWE-S-25-G 1"-wd-SC	439,00
S	250	30	1 1/4"					50	DGWE-S-30-G 1 1/4"-wd-SC	*
S	250	38	1 1/2"					60	DGWE-S-38-G 1 1/2"-wd-SC	*



Winkel-Drehverschraubungen

Einschraubgewinde G: Whitworth-Rohrgewinde - Zylindrisch
Ausführung: Gehäuse aus Vierkantstahl

Dichtungskombination:

- O-Ring + wd = Viton / FPM
- Stützring = PTFE

Elbow Rotary Couplings

Thread G: BSP - Parallel

Construction: Bodies made from Steel Bar

Sealing Combination:

- O-Ring + wd-Sealing = Viton / FPM
- Backing Ring = PTFE

Reihe Series	Druck Pressure PB	Rohr A.D. Tube O.D.		Ca. Maße Approx. Dimensions				Bestellzeichen Order-Code OMD	Brutto-Preis Gross-Price Euro (€)
		D1	G						
L	250	6	1/8"					DGWE-L-06-G 1/8"-wd-OMD	253,69
L	250	6	1/4"					DGWE-L-06-G 1/4"-wd-OMD	253,69
L	250	6	3/8"					DGWE-L-06-G 3/8"-wd-OMD	297,69
L	250	8	1/4"					DGWE-L-08-G 1/4"-wd-OMD	253,20
L	250	8	3/8"					DGWE-L-08-G 3/8"-wd-OMD	297,20
L	250	10	1/4"					DGWE-L-10-G 1/4"-wd-OMD	252,64
L	250	10	3/8"					DGWE-L-10-G 3/8"-wd-OMD	296,64
L	250	12	1/4"					DGWE-L-12-G 1/4"-wd-OMD	252,11
L	250	12	3/8"					DGWE-L-12-G 3/8"-wd-OMD	296,11
L	250	12	1/2"					DGWE-L-12-G 1/2"-wd-OMD	336,11
L	250	15	1/2"					DGWE-L-15-G 1/2"-wd-OMD	334,86
L	160	18	1/2"					DGWE-L-18-G 1/2"-wd-OMD	331,38
L	160	22	3/4"					DGWE-L-22-G 3/4"-wd-OMD	373,69
L	100	28	1"					DGWE-L-28-G 1"-wd-OMD	421,15
L	100	35	1 1/4"					DGWE-L-35-G 1 1/4"-wd-OMD	*
L	100	42	1 1/2"					DGWE-L-42-G 1 1/2"-wd-OMD	*

Reihe Series	Druck Pressure PB	Rohr A.D. Tube O.D.		Ca. Maße Approx. Dimensions				Bestellzeichen Order-Code OMD	Brutto-Preis Gross-Price Euro (€)
		D1	G						
S	400	6	1/4"					DGWE-S-06-G 1/4"-wd-OMD	253,21
S	400	6	3/8"					DGWE-S-06-G 3/8"-wd-OMD	297,21
S	400	8	1/4"					DGWE-S-08-G 1/4"-wd-OMD	252,80
S	400	8	3/8"					DGWE-S-08-G 3/8"-wd-OMD	296,80
S	400	10	1/4"					DGWE-S-10-G 1/4"-wd-OMD	296,06
S	400	10	3/8"					DGWE-S-10-G 3/8"-wd-OMD	296,06
S	400	12	3/8"					DGWE-S-12-G 3/8"-wd-OMD	295,55
S	400	14	1/2"					DGWE-S-14-G 1/2"-wd-OMD	334,50
S	400	16	1/2"					DGWE-S-16-G 1/2"-wd-OMD	331,79
S	250	20	3/4"					DGWE-S-20-G 3/4"-wd-OMD	373,42
S	250	25	1"					DGWE-S-25-G 1"-wd-OMD	417,38
S	250	30	1 1/4"					DGWE-S-30-G 1 1/4"-wd-OMD	*
S	250	38	1 1/2"					DGWE-S-38-G 1 1/2"-wd-OMD	*







Vormontagegestutzen und Schmierstoffe Pre-Installation Dies and Lubricants





VORMONTAGESTUTZEN UND SCHMIERSTOFFE PRE-INSTALLATION DIES AND LUBRICANTS

Produktgruppen	Product Groups	Seite Page
 Vormontagestutzen	<i>Pre-Installation Dies</i>	12.2
 Schmierstoffe	<i>Lubricants</i>	
- Öl-Jokisch HDS 400	- <i>Oil-Jokisch HDS 400</i>	12.3
- Weiße Paste - Gleitmo 810	- <i>White Grease Paste - Gleitmo 810</i>	12.4
- High-Tech Paste ASW 040 P	- <i>High-Tech Grease Paste ASW 040 P</i>	12.5
- Weiße Fettpaste - Gleitmo 815	- <i>White Grease Paste - Gleitmo 815</i>	12.6

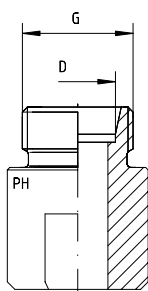

Stahl - Gehärtet
Für Montage von Hand

Steel - Hardened
For Assembly by Hand

Reihe Series	Rohr A.D. Tube O.D. D	Gewinde Thread G	Bestellzeichen Order-Code	Netto-Preis Net-Price Euro (€)
LL	4	M 8 x 1	VOST-LL-04	37,90
LL	6	M 10 x 1	VOST-LL-06	37,90
LL	8	M 12 x 1	VOST-LL-08	39,35

Reihe Series	Rohr A.D. Tube O.D. D	Gewinde Thread G	Bestellzeichen Order-Code	Netto-Preis Net-Price Euro (€)
L	6	M 12 x 1,5	VOST-L-06	29,70
L	8	M 14 x 1,5	VOST-L-08	29,70
L	10	M 16 x 1,5	VOST-L-10	32,10
L	12	M 18 x 1,5	VOST-L-12	32,10
L	15	M 22 x 1,5	VOST-L-15	37,20
L	18	M 26 x 1,5	VOST-L-18	46,20
L	22	M 30 x 2	VOST-L-22	56,20
L	28	M 36 x 2	VOST-L-28	60,50
L	35	M 45 x 2	VOST-L-35	93,05
L	42	M 52 x 2	VOST-L-42	138,50

Reihe Series	Rohr A.D. Tube O.D. D	Gewinde Thread G	Bestellzeichen Order-Code	Netto-Preis Net-Price Euro (€)
S	6	M 14 x 1,5	VOST-S-06	31,10
S	8	M 16 x 1,5	VOST-S-08	32,10
S	10	M 18 x 1,5	VOST-S-10	32,10
S	12	M 20 x 1,5	VOST-S-12	35,20
S	14	M 22 x 1,5	VOST-S-14	37,20
S	16	M 24 x 1,5	VOST-S-16	46,20
S	20	M 30 x 2	VOST-S-20	54,76
S	25	M 36 x 2	VOST-S-25	56,55
S	30	M 42 x 2	VOST-S-30	95,20
S	38	M 52 x 2	VOST-S-38	133,15

Kein Rabatt!
No discount!



ÖI-Jokisch HDS 400 á 250 ml
Für die Montage von Schraubverbindungen aus Edelstahl
-20°C bis +120°C

*Oil-Jokisch HDS 400 á 250 ml
For Assembly of Stainless Steel Couplings
-20°C to +120°C*

	Bestellzeichen Order-Code	Netto-Preis Net-Price Euro (€)
	ÖI-HDS 250 ml	9,70

Kein Rabatt!
No discount!



Weißer Paste - Gleitmo 810 á 100 g
Für die Montage von Schraubverbindungen aus Edelstahl
-25°C bis +80°C

White Grease Paste - Gleitmo 810 á 100 g
For Assembly of Stainless Steel Couplings
-25°C to +80°C

	Bestellzeichen <i>Order-Code</i>	Netto-Preis <i>Net-Price</i> Euro (€)
	Gleitmo 810	16,50

Kein Rabatt!
No discount!



High-Tech Paste ASW 040 P á 120 g

- Metallfrei

Für die Montage von Schraubverbindungen aus Edelstahl
-40°C bis +1400°C

High-Tech Grease Paste ASW 040 P á 120 g

- Metallfrei

For Assembly of Stainless Steel Couplings
-40°C to +1400°C

	Bestellzeichen Order-Code	Netto-Preis Net-Price Euro (€)
	ASW 040P-120 g	11,10

Kein Rabatt!
No discount!

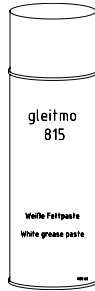

Weiße Fettpaste - Gleitmo 815 - Sprühdose á 400 ml
Für die Montage von Schraubverbindungen aus Edelstahl
-45°C / +110°C; kurzzeitig bis 180°C

White Grease Paste - Gleitmo 815 - Aerosol á 400 ml
For Assembly of Stainless Steel Couplings
-45°C / +110°C; short-term up to 180°C

	Bestellzeichen <i>Order-Code</i>	Netto-Preis <i>Net-Price</i> Euro (€)
	Gleitmo 815	19,85

Kein Rabatt!
No discount!



EDELSTAHL / STAINLESS STEEL
VERBINDUNGSTECHNIK
FLUID CONNECTORS

Kugelhähne und Absperrventile Ball Valves and Spindle Valves











13



KUGELHÄHNE UND ABSPERRVENTILE

BALL VALVES AND SPINDLE VALVES

	Produktgruppen	Product Groups	Seite Page
	Edelstahl-Kugelhähne - RKH - Allgemeine Hinweise - Edelstahl-Kugelhähne - RKH - Bestellzeichen - Werkstoffkombinationen - RKH - Edelstahl-Kugelhähne - RKH - Anschlussarten	Stainless Steel - Ball Valves - RKH - General Refernces - Stainless Steel - Ball Valves - RKH - Order-Code - Combination of Materials - RKH - Stainless Steel - Ball Valves - RKH - Connection	13.2 - 13.7 13.8 - 13.9 13.10 13.11
	Dreiwege-Umschalt-Kugelhähne - BK 3 - Dreiwege-Umschalt-Kugelhähne - BK 3 - Bestellzeichen - Werkstoffkombinationen - BK3-LA - Bestellzeichen - Werkstoffkombinationen - BK3-TA - Dreiwege-Umschalt-Kugelhähne - BK3-Anschlussarten	Three-Way Ball Valves - BK 3 - Three-Way Ball Valves - BK 3 - Order-Code - Combination of Materials - BK3-LA - Order-Code - Combination of Materials - BK3-TA - Three-Way Ball Valves - BK3-Connection	13.12 - 13.13 13.14 13.15 13.16
	Hochdruck-Flansch-Kugelhähne	High Pressure Flange Ball Valves	13.17
	Niederdruck-Kugelhähne - Volle Bohrung	Low Pressure Ball Valves - Full-Port	13.18
	Niederdruck-Kugelhähne - L-Bohrung	Low Pressure Ball Valves - L-Port	13.19
	Niederdruck-Kugelhähne - T-Bohrung	Low Pressure Ball Valves - T-Port	13.20
	Hochdruck-Absperrventile - Hochdruck-Absperrventile	High Pressure Valves - High Pressure Valves	13.21 13.22
	Nadelventile - Nadelventile - NV - Technische Daten / Druckverlust	Needle Valves - Needle Valves - NV - Technical Data / Pressure Drop	13.23 13.24

1. Allgemeine Hinweise

Kugelhähne werden zum Durchfluss bzw. zur Absperrung des Durchflusses von Medien unter Druck eingesetzt.

Die Kugelhahn- und Dichtungswerkstoffe werden durch den Hersteller des Kugelhahnes entsprechend den Kundenangaben wie Medium, Druck und Temperatur sowie weiteren Kundenspezifikationen (Lastenheft) ausgewählt.

Die Benutzung anderer als in der Bestellung angegebener Medien führen zu einer Verkürzung der Lebensdauer bzw. zum Ausfall des Kugelhahnes. Die Druck- und Temperaturgrenzwerte müssen eingehalten werden. (Siehe auch Kugelhahnkennzeichnung.)

Bei der Planung und Auslegung von Kugelhähnen muss der Kunde deshalb, möglich auftretende Arbeitsdrücke (Druckschläge/Impulsdrücke) mit einbeziehen. Druckangaben im Katalog beziehen sich auf statische Belastungen (Lastfall I). Für schwellende oder wechselnde Belastungen (Lastfall II und III) sind entsprechende Druckabschläge mit einzubeziehen.

Kugelhähne sind ausschließlich für den Einbau in Rohrleitungssysteme mit Anschlüssen gleicher Druckstufe und entsprechendem Anschluss oder zwischen Flanschen gleicher Druckstufe und gleichem Flanschanschluss bestimmt.

Kugelhähne öffnen und schließen bei Drehung der Schaltwelle um jeweils 90°. Die Schließrichtung erfolgt nach EN ISO 5211 Punkt 8 im Uhrzeigersinn. Eine Kerbe an der Stirnfläche der Schaltwelle zeigt die Schaltstellung des Kugelhahnes an.

Die Kugelhähne können wahlweise mittels Handgriff oder Antrieb betätigt werden. Dieses ist bei der Bestellung von Kugelhähnen anzugeben.

Für Anbauteile, wie z.B. Antriebe und Positionsschalter, ist die Betriebsanleitung der jeweiligen Hersteller gültig.

Bei dem Einsatz in explosionsgefährdeten Bereichen zählen Kugelhähne zu nicht-elektrischen Geräten und da nach 94/9/EG keine potentielle Zündquelle vorhanden ist, unterliegen sie damit nicht der ATEX.

2. Einbauhinweise

Vor dem Einbau ist zu überprüfen, ob die Kugelhahnausführung der geforderten Ausführung entspricht und für den vorgesehenen Einsatz geeignet ist.

Der Einbau von Kugelhähnen darf nur von qualifiziertem Personal und im drucklosen Zustand des Kugelhahnes und des Rohrleitungssystems durchgeführt werden. Die Rohrleitungen sind spannungsfrei an die einzubauende Armatur heranzuführen!

Vor dem Einbau sind die Kugelhähne auf Transportschäden zu prüfen. Beschädigte Kugelhähne dürfen nicht eingebaut werden.

1. General Reference

Ball valves are used to shut-off pressurised media in pipes or hoses

According to the user's indication of medium, pressure, temperature and other details, the manufacturer selects the material of the housing, the seats and the seals of the ball valve (requirement specification).

The use of media other than stated in the order leads to a reduced service life of the ball valve or to its failure.

The limit values of pressure and temperature must be observed. (See also marking on the ball valve.)

When planning or determining ball valves, emerging working pressures (pressure peaks/impulse pressures) must be taken into consideration by the user.

Ball valves are intended for assembly in pipe systems with identical pressure ratings in between the fittings or in between the flanges.

Ball valves open and close by 1/4 turn operations. According to EN ISO 5211.8, the handle must be turned clockwise in order to close the ball valve. The notch on the face of the spindle square indicates the current position of the ball.

Ball valves can be operated either by handle or by actuator. The operation method has to be mentioned when ordering the ball valve.

Attachments, such as actuators and limit switches, always refer to the operating manual of the respective manufacturer.

When ball valves come into operation in explosive zones, they are considered as non-electrical equipment, because there ignition source acc. to EC directive 94/9EG and therefore ball valves are not subject to ATEX.

2. Fitting Guidelines

Before installing the ball valve, an appropriate check whether the ball valve meets all necessary requirements regarding version and application is advisable.

The installation of ball valves may be done only by qualified personnel and only when pipe and ball valve are depressurized. Pipe must be free of traction when being connected to the ball valve.

Ball valves must be reviewed for damage in transit before installing. Damaged ball valves must not be installed.

All pipes and hoses must be rinsed thoroughly before the installation of the valves. Residues in the pipe system damage the sealing elements of the ball valve and lead to leaks and dysfunctions.

Vor dem Einbau der Kugelhähne sind alle Rohrleitungen durchzuspülen. Rückstände in Rohrleitungen beschädigen die Dichtelemente der Kugelhähne und führen dadurch zu Undichtheiten und Funktionsstörungen.

Beim Anziehen der Verschraubungen (Kundenanschlüsse) muss unbedingt mit einem geeigneten Werkzeug gegengehalten werden.

Die Kugelhahnanschlüsse dürfen nicht weiter in das Gehäuse eingedreht bzw. dürfen nicht herausgedreht werden, da sich sonst das Umschaltmoment erhöht bzw. Undichtheiten entstehen können. Nach dem Einbau des Kugelhahnes ist als Funktionsprobe eine Schaltung durchzuführen.

Es dürfen keine Teile des Kugelhahnes, z.B. Deckel, Anschlußstutzen, gelöst oder heruntergeschraubt werden.

Bei gesundheitsschädlichen, brennbaren und explosiven Medien ist auf vollständige Entleerung des Rohrleitungssystems und des Kugelhahnes zu achten! Vor evtl. nachfließenden Rückständen wird gewarnt! Entsprechende Schutzkleidung ist zu tragen!

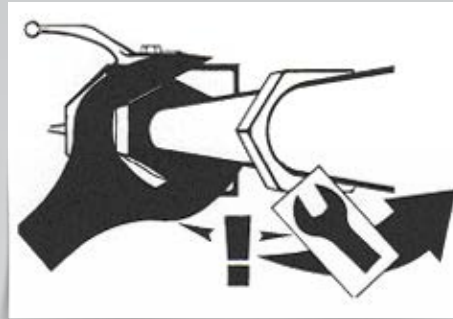

Kugelhähne mit Flanschanschluss müssen durch die Schrauben der Gegenflansche zentriert sein, bevor alle Schrauben der Flanschverbindung kreuzweise angezogen werden. Die Armatur ist gegebenenfalls mittels Hebezug zwischen die Rohrleitung zu setzen. Zwischen den Flanschen ist eine lt. Norm vorgeschriebene, unbeschädigte Dichtung zu verwenden. Die Stehbolzen oder Verbindungsschrauben müssen den Flanschen entsprechend ausgewählt werden, unter Berücksichtigung von Größe und Festigkeitsklasse. Bei Sackgewinden ist darauf zu achten, dass die maximale Einschraubtiefe nicht überschritten wird.

Bei Kugelhähnen mit Anschweißenden ist unbedingt darauf zu achten, dass beim Einbau (Schweißen) keine Schweißpartikel in den Hahninnenraum gelangen. Schweißrückstände sind unbedingt zu entfernen. Ebenso ist darauf zu achten, dass der Kugelhahninnenraum nicht über die zulässigen Temperaturgrenzen erwärmt wird. Überschreitung dieser Temperatur kann zu Beschädigungen an Dichtelementen führen. Die Schaltstellung des Kugelhahnes nach Rohrleitungsplan ist zu beachten.

Druckstufe, Anschluss und Baulänge des Rohrleitungssystems müssen mit dem Kugelhahn übereinstimmen.

Für Anbauteile, wie z.B. Antriebe, ist die Betriebsanleitung der jeweiligen Hersteller unbedingt zu beachten.

3. Inbetriebnahme

Vor der ersten Inbetriebnahme sind alle Betriebshinweise zu lesen und zu beachten und nochmals alle Betriebsbedingungen und Montagearbeiten zu überprüfen.

When tightening the fittings (pipe end), it is absolutely necessary that the end-adaptor of the ball valve is counter-secured with an adequate tool.

The ends of the ball valve must not be turned in any further or unscrewed, because this leads to an increase of the breakaway torque or to leakage.

After the installation of the ball valve, a functional test must be carried out.

No components of the ball valve, such as adaptors or top flanges may be taken off or unscrewed.

The ball valve and the entire pipe system has to be drained completely, when dealing with noxious, combustible and explosive media! Possibly dropping residues must be taken into account! Appropriate protective clothing is necessary!

Ball valves with flange connection must be centred with the bolts of the counter flanges, before the screws are tightened crosswise. Where necessary, the valve has to be lifted into the pipe-system with a hoist. An undamaged seal that meets the respective norm has to be fitted in between the flanges. Screws or dowel pins must be selected according to the flanges considering the size and the strength category. The length of engagement has to be respected, especially for tapped holes.

Ball valves with welding ends must be welded in without any welding particles left in the internal space of the ball valve. Residues from welding must be eliminated unconditionally. It must be pointed out that the cavity of the ball valve does not exceed the tolerable temperature limits. Crossing the limits can cause damage of the seats and seals.

The operating position of the ball valve must be in accordance to the layout of the pipe-system.

Pressure rating, connection and overall length of the pipe-system must correspond with the ball valve.

For optional attachments, such as actuators, always refer to the operating manual of the respective manufacturer.

3. Initial Operation

Before the initial operation, all instructions must be read and taken into consideration and all conditions of operating and installing have to be approved.

Die Inbetriebnahme einer Anlage darf nur von qualifiziertem Personal durchgeführt werden.

Bei längerer Lagerung des Kugelhahnes oder längerer Stillstandszeit in einer Schaltstellung liegt das Drehmoment beim ersten Schaltvorgang deutlich über dem tatsächlichen Drehmoment (Losreißmoment).

Das Rohrleitungssystem muss vor der Inbetriebnahme entlüftet werden. Luftblasen im Rohrleitungssystem können bei schlagartigem Druckaufbau zu Explosionen führen. Den Betriebsdruck deshalb in Stufen aufbauen.

Sind Kugelhähne als Endarmaturen im Rohrleitungssystem eingebaut, müssen, da bei Anwendungsfehler Lebensgefahr durch ausreißende Teile besteht, ungenutzte Kugelhahnanschlüsse entsprechend fachmännisch verschlossen werden.

4. Wartung/Inspektion

Bei Entleerung des Rohrleitungssystems, z.B. bei Frostgefahr oder Reinigungsarbeiten, müssen Kugelhähne über eine 45°-Schaltstellung ebenfalls entleert werden (Gehäusehohlraum).

Kugelhähne dürfen nicht demontiert werden. Notdürftige Abdichtungen jeglicher Art sind verboten.

Kugelhähne müssen in regelmäßigen Abständen auf Dichtheit, Funktion und Beschädigungen überprüft werden. Bei extremer Beanspruchung ist die Überprüfung in kürzeren Zeitabständen durchzuführen.

Zur Erhaltung der Funktionstüchtigkeit ist es bei längerer Stillstandszeit erforderlich, den Kugelhahn mindestens halbjährlich zu schalten.

Werden bei Wartungsarbeiten bzw. Inspektionen fehlerhafte Kugelhähne, z.B. undichte, nicht mehr korrekt umschaltbare, korrodierte Kugelhähne festgestellt, müssen diese unverzüglich ausgetauscht werden.

5. Ausbauhinweise

Der Ausbau von Kugelhähnen darf nur von qualifiziertem Personal und im drucklosen Zustand des Kugelhahnes und des Rohrleitungssystems durchgeführt werden.

Vor dem Ausbau den Druck im Rohrleitungssystem abbauen. Den Kugelhahn durch Schalten in halboffener Stellung mit einbeziehen, damit der Druck im Gehäusehohlraum ebenfalls abgebaut wird.

Bei gesundheitsschädlichen, brennbaren und explosiven Medien ist auf vollständige Entleerung des Rohrleitungssystems und des Kugelhahnes zu achten!

Vor evtl. nachfließenden Rückständen wird gewarnt!
Entsprechende Schutzkleidung ist zu tragen!

The initial operation of an installation should be effected by qualified personnel, only.

After a long-time of storage or after an extended shutdown in one operating position, the operating torque for the first operation is noticeably higher compared to the real breakaway torque.

The piping system must be bled, before the initial operation. Air bubbles in the piping system might lead to explosions when pressurised abruptly. Therefore, a successive establishing of the pressure is advisable.

When ball valves are installed as pipe-line-ends, the open adaptor must be closed properly, because, due to handling errors, tom-out components can lead to a possible catastrophic failure or even death.

4. Maintenance and Surveying

When draining the depressurized pipe system, in order to prevent it from frost damage or for a cleaning process, the cavity of the ball valve has to be drained by opening the valve to the mid-position (45°).

Ball valves must not be detached. All types of provisional sealants are prohibited.

Ball valves must be inspected at regular intervals for tightness, function and damage. In case of a heavy duty application, the inspection interval has to be abbreviated.

Ball valves, that are installed for long-term periods without being operated, must be turned every six months, at least, in order to preserve their function.

When surveying of ball valves results in defective ball valves, e.g. leakage, immovable or corroded, they must be replaced without delay.

5. Removal Instructions

The removal of ball valves should be done by qualified personnel and only, when the ball valve and the pipe system are depressurized.

Before removal, the pressure in the pipe system must be relieved. The ball valve must be in mid-position (45°), in order to relieve the pressure in the cavity as well.

The ball valve and the entire pipe system has to be drained completely, when dealing with noxious, combustible and explosive media!

*Possibly dropping residues must be taken into account!
Appropriate protective clothing is necessary!*

6. Warnhinweise

- Gegenhalten bei Montage
- Nicht unter Druck demontieren

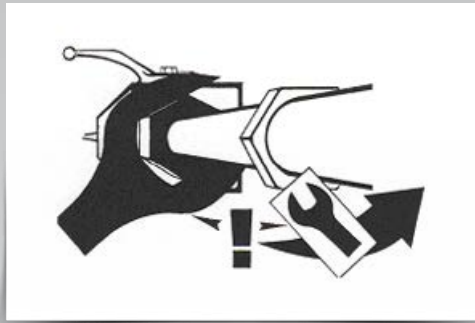

- Nicht mit Werkzeugen schalten
- Nicht Schweißen, Bohren, etc.

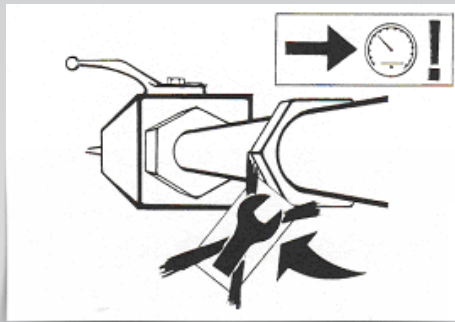

- Nicht demontieren
- Verletzungsgefahr durch Rückstände

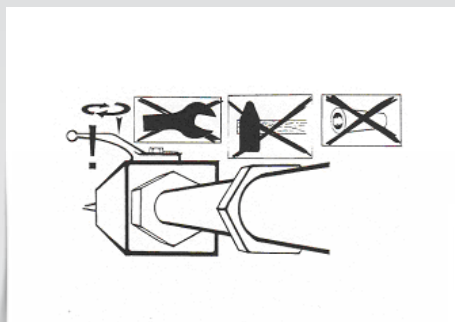

Diese Betriebsanleitung ist zur Kenntnis zu nehmen. Bei Nichtbeachtung der Betriebsanleitung übernimmt der Hersteller der Kugelhähne keine Haftung!

Kugelhähne sind nur für den vom Hersteller angegebenen Verwendungszweck zu benutzen!

6. Warning

- Secure adaptor during installation
- No welding, drilling, etc.

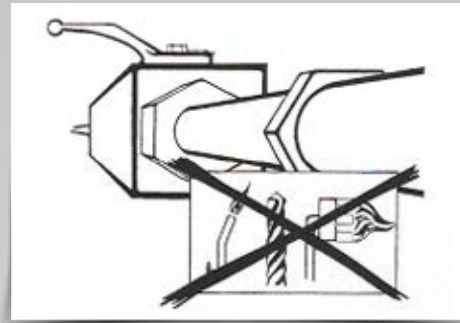

- Don't remove under pressure
- Don't dismantle

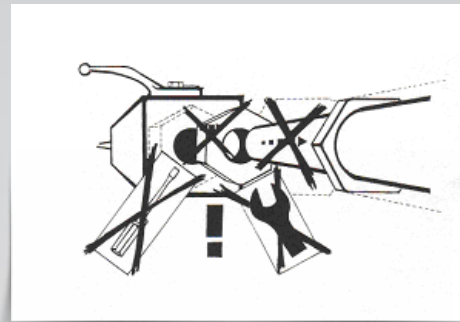

- Don't operate a ball valve with a tool or an extension
- Risk of injury by remainders

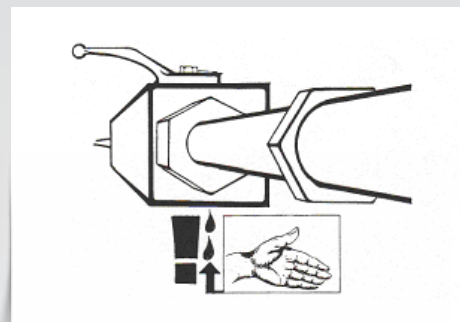

This operating manual has to be adhered to. The manufacturer of the ball valves assumes no liability when this operating manual is not observed!

Ball valves are to be used only for the application declared by the manufacturer!

Bei Schäden durch fehlerhaften Einbau und Anwendung von Kugelhähnen, sowie falscher Benutzung durch unqualifiziertes Personal übernimmt der Hersteller der Kugelhähne ebenfalls keine Haftung.

Kugelhähne sind grundsätzlich bis zum Anschlag durchzuschalten. Sie dürfen nur in den Schaltstellungen vollständig geschlossen oder vollständig geöffnet benutzt werden!

Zur Drosselung und Regulierung von Durchflussmengen sind Kugelhähne nicht zugelassen! Indifferente Schaltstellungen führen zu Beschädigung der Dichtungen im Kugelbereich. Die Kugelhähne werden dadurch undicht bzw. sind nicht mehr schaltbar. Außerdem ergibt sich eine zu berücksichtigende Temperaturerhöhung an der Oberfläche des Kugelhahns.

Werkzeuge (z.B. Zangen, Hammer, Gabelschlüssel, Verlängerungen usw.) dürfen zum Umschalten der Kugelhähne nicht verwendet werden. Die Verwendung solcher Werkzeuge kann zu Beschädigungen an Schaltelementen und Gehäusen führen.

Kugelhähne dürfen nicht mit Gewalt geschaltet werden.

Besondere Einsatz- oder Umgebungsbedingungen (Feuchtigkeit, Vibrationen, Schalthäufigkeit, elektromagnetisches Feld, explosionsgefährdeter Bereich und Antistatik, etc.) müssen bei der Bestellung von Kugelhähnen klar definiert werden.

Kugelhähne sind nur für angegebene Medien zu benutzen!
Zähflüssige oder aushärtbare Medien dürfen nicht verwendet werden.

Verschmutzungen sind unbedingt zu vermeiden. Verschmutzte Medien führen zu Beschädigungen der Dichtelemente. Dadurch entstehen Undichtheiten die zum Ausfall des Kugelhahnes führen.

Die Temperaturgrenzen von -10°C bis +50°C sind nicht zu über- und unterschreiten, sonst frühzeitiges Ausfallen des Kugelhahns möglich. Kugelhähne sind im Anlieferungszustand trocken und schmutzfrei werden. Schutzkappen erst beim Einbau entfernen. Unverpackte Kugelhähne sind vor direkter UV- und/oder Sonneneinstrahlung zu schützen.

Im explosionsgefährdeten Bereich zur Vermeidung von Eigenerwärmung sind die Schaltungen der Kugelhähne auf max. 10 x je Minute zu begrenzen. Überschreitung des angegebenen Betriebsdruckes bzw. Über- und Unterschreitung der Betriebstemperatur führt zur Undichtheit und Zerstörung des Kugelhahnes!
Achtung: Gefährdung von Menschenleben!

Speziellen Warnhinweisen, z.B. dem Tragen von Handschuhen beim Schalten, ist Folge zu leisten. (Kugelhahn nimmt die Mediumstemperatur an)

Jede bauliche Veränderung des Kugelhahnes, insbesondere das Anbringen von Bohrungen und das Anschweißen von Gegenständen (Platten, Halterungen usw.) ist strengstens untersagt.

Bei Funktionsstörungen ist der Kugelhahn durch qualifiziertes Personal im drucklosen und entleerten Zustand des Rohrleitungssystems

For damage caused by incorrect installation or implementation as well as incorrect handling by unqualified personnel, the manufacturer of the ball valve assumes no liability.

The operating distance of ball valves is strictly from stop-pin to stop-pin. They must be operated in either fully open or completely closed position, only.

Ball valves are not approved for controlling or throttling of flow. Intermediate positions cause damage of the ball seats. This leads to leaking ball valves or to non-turnable spindles. Furthermore, flow reduction leads to a considerable rise of temperature on the surface of the ball valve.

Tools (e.g. gripper, hammer, wrench, extensions, etc.) are inapplicable for ball valve operations. The use of such tools might cause damage to the spindle and on the body.

Special applications or ambient conditions (humidity, vibrations, operation frequency, electromagnetic fields, explosive zones, antistatic, etc.) must be well-defined when ordering ball valves!

*Ball valves must be used for indicated media, only!
Semifluid or hardening media must not be used.*

Contamination must be avoided. Contaminated media lead to damage of the sealing elements. Consequently, leakage will lead to the breakdown of the ball valve.

Temperature limits must not be exceeded or undercut, otherwise the ball valve might fail at an early stage. Ball valves must be stored as supplied, dry and free of contamination. Only before installation, the protective caps shall be removed. Unpacked ball valves must be protected from ultraviolet and solar radiation.

When installed in explosive zones, the operation frequency should be limited to 10/min., in order to prevent the ball valves from self warming.

Exceeding of the nominal pressure and exceeding or undercutting of the working temperature respectively, leads to leakage and destruction of the ball valve.

Caution: Danger of life !

Certain warnings, e.g. wearing gloves when turning the handle, must be obeyed. (The ball valve adopts the temperature of the fluid.)

Any modification of the ball valve design, especially the drilling of mounting holes or the attachment of plates by welding, is strictly forbidden.

In case of malfunction, the ball valve must be replaced by qualified personnel after depressurizing and draining the pipe system. If necessary, the system must be put out of operation.

A repair is realisable by the manufacturer, only !



auszutauschen. Gegebenenfalls ist die Anlage abzuschalten und außer Betrieb zu nehmen.

Eine Reparatur ist nur durch den Hersteller zulässig!

Bei unzulässiger Demontage des Kugelhahnes durch unqualifiziertes Personal erlischt jeder Garantie- und Schadenanspruch an den Hersteller!

Nationale Vorschriften zur Unfallverhütung sowie ortsgebundene Sicherheitsvorschriften des Betreibers werden durch diese Betriebsanleitung nicht ersetzt und sind in jedem Falle als vorrangig zu betrachten.

Vor sämtlichen Instandsetzungsarbeiten ist sicherzustellen bzw. zu beachten

- An automatisierten Armaturen grundsätzlich vor Reparatur- und Wartungsarbeiten die Energieversorgung zu den Antrieben unterbrechen. (Quetschgefahr!)
- Inbetriebnahme der Anlage durch Dritte ausschließen.
- Entleerung der Rohrleitung sowie Druckpolster abbauen.
- Sich über mögliche Gefahren, welche durch Rückstände des Betriebsmediums entstehen können, zu informieren, gegebenenfalls Sicherheitshandschuhe, Schutzbrille etc. tragen.
- Gegebenenfalls Armaturen abkühlen lassen.
- Grenzwerte hinsichtlich Druck, Temperatur, und Medium nicht überschreiten.

Warnung!

Falsche oder unsachgemäße Auswahl bzw. unsachgemäße Anwendung von Produkten und/oder Geräten aus diesem Katalog kann zu Tod, Verletzung und/oder Sachschaden führen.

Dieser Katalog und andere Unterlagen von PH-Industrie-Hydraulik stellen Produktinformationen dar, die dem technisch versierten Anwender als Unterlage zur Produktauswahl dienen sollen. Es ist unbedingt darauf zu achten, dass sämtliche anwendungsspezifischen Kriterien zur Entscheidungsfindung bei der Produktauswahl aus diesem Katalog berücksichtigt werden. Aufgrund der Vielfalt der Einsatzmöglichkeiten und Anwendungsbereiche der in diesem Katalog aufgeführten Produkte, ist der Anwender für die endgültige Auswahl des Produktes verantwortlich, indem er sicherstellt, dass alle Funktionen, Sicherheitsvorschriften und Vorsichtsmaßnahmen erfüllt werden.

PH-Industrie-Hydraulik behält sich vor, alle in diesem Katalog gemachten Angaben bzgl. Produktmerkmalen, Varianten, Ausführungen, Verfügbarkeit und Preis jederzeit und ohne Vorankündigung zu ändern.

When ball valves are dismantled improperly by unqualified personnel, any claim of guarantee and damage against the manufacturer are null and void.

National regulations for accident prevention such as local safety regulations of the operating company are not replaced by this manual, they should rather be considered with priority.

Before any maintenance is performed, the following has to be adhered to :

- *The power supply of actuators must be disconnected (risk of squeezing).*
- *Start-up by third party must be excluded.*
- *Draining of the pipe system and relieve of pressure.*
- *Be aware of possible remainders of media and the risks they are bearing (where required, protective clothing (gloves, glasses) is necessary)*
- *Where applicable, cool down installation.*
- *Do not exceed limits regarding pressure, temperature and media.*

Warning!

Failure or improper selection or improper use of any of the products and/or systems found in this catalogue can cause death, personal injury and/or property damage.

This catalogue and other information from PH-Industrie-Hydraulik provides product options for further investigation by users having technical expertise. It is important that you analyse all aspects of your application and review the information concerning the product in the current product catalogue. Due to the variety of operating conditions and applications for these products, the user, through its own analysis and testing, is solely responsible for making the final selection of the products and assuring that all performance, safety and warning requirements of the application are met.

The products described herein, including without limitation, product features, specifications, designs, availability and pricing, are subject to change by PH-Industrie-Hydraulik at any time without notice.



Edelstahl-Kugelhähne - RKH

Serie 020
DN 4 bis DN 50

Gehäuse, Stutzen, Kugel und Schaltwelle nichtrostender Stahl, V4a (AISI 316)

Unsere Kugelhähne werden einzeln einer Prüfung auf Festigkeit, Dichtheit und besonderen geltenden Richtlinien unterzogen.

Abnahmeprüfzeugnis 3.1 B oder 3.1 C nach DIN EN 10204 kann auf Anfrage, gegen Berechnung, mitgeliefert werden.

Andere Werkstoffe wie 254Smo oder Hastelloy, etc. auf Anfrage.

Stainless Steel - Ball Valves - RKH

Serie 020
DN 4 to DN 50

Body, Connecting Parts, Ball and Stem Stainless Steel, V4a (AISI 316)

Each PH ball valve is subject to an inspection for resistance, sealing and special characteristics.

Inspection control certificates 3.1 B or 3.1 C per DIN EN 10204 can be supplied on request against invoice.

Other materials as 254Smo or Hastelloy, etc. on request.

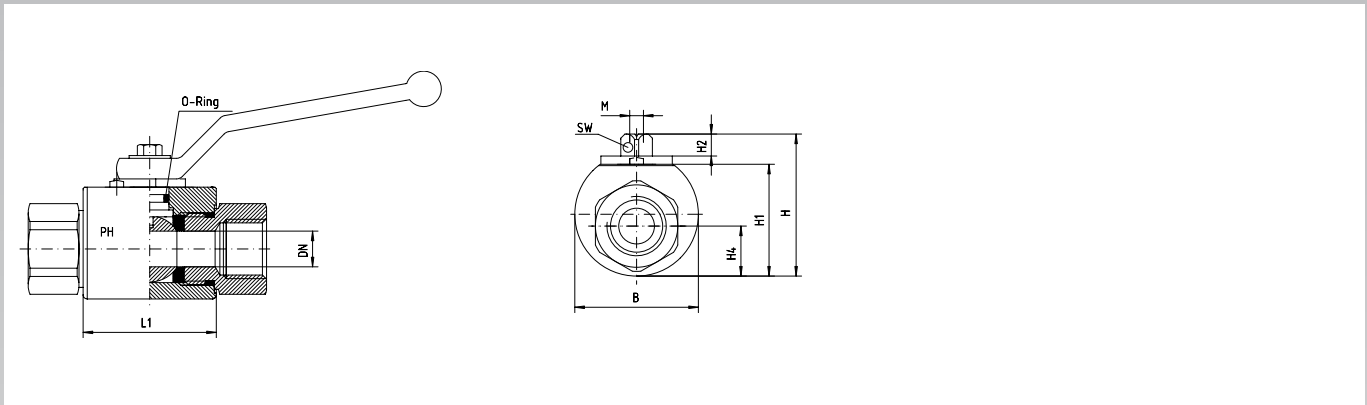

DN mm	PB bar	L1 mm	B mm	H mm	H1 mm	H2 mm	H4 mm	M mm	SW \varnothing mm
5	500	36	35	43,5	32	8,0	13,0	M 5	9
6	500	36	35	43,5	32	8,0	13,0	M 5	9
8	500	36	35	43,5	32	8,0	13,0	M 5	9
10	500	43	42	49,5	38	8,0	16,5	M 5	9
13	500	48	45	51,5	40	8,0	17,5	M 5	9
16	400	48	50	62,0	46	12,0	19,0	M 6	12
20	400	62	60	73,0	57	12,0	24,5	M 6	14
24	400	66	65	79,0	63	12,0	28,0	M 6	14
32	350	81	90	104,0	84	13,5	38,0	M 8	17
38	350	86	100	112,0	93	13,5	42,5	M 8	17
48	350	101	120	131,0	111	13,5	50,0	M 8	17

Der angegebene Betriebsdruck PB ist nur gültig für die Standardausführung 4423.
The indicated working pressure PB is only valid for the standard version 4423.

Gehäusemaße gültig für alle Kombinationen.
Body dimensions are for all the combinations.

BESTELLZEICHEN - WERKSTOFFKOMBINATIONEN

ORDER-CODE - COMBINATION OF MATERIALS



Maßänderungen vorbehalten.

Measurements subject to alteration.

Gehäuseteile Kugel Schaltwelle Kugeldichtung Schaltwellendichtung		Body Ball Stem Ball Sealing Stem Sealing		V4a (AISI 316) V4a (AISI 316) V4a (AISI 316) PTFE (bis/to 100 bar) FKM		V4a (AISI 316) V4a (AISI 316) V4a (AISI 316) PTFE (bis/to 100 bar) EPDM		V4a (AISI 316) V4a (AISI 316) V4a (AISI 316) POM NBR		
				Korrosive Medien <i>Corrosive Media</i>		Wasser und Dampf <i>Water and Steam</i>		Hydraulik - Standardausführung <i>Hydraulics - Standard Version</i>		
				-20°C bis/to 100°C		-20°C bis/to 140°C		-20°C bis/to 100°C		
Anschlussart <i>Connection</i>		DN	D	RA	Bestellzeichen <i>Order-Code</i>	Brutto-Preis <i>Gross-Price</i> Euro (€)	Bestellzeichen <i>Order-Code</i>	Brutto-Preis <i>Gross-Price</i> Euro (€)	Bestellzeichen <i>Order-Code</i>	Brutto-Preis <i>Gross-Price</i> Euro (€)
01 • Rohrgewinde • DIN ISO 228 • <i>BSP Female Thread</i> • <i>DIN ISO 228</i>		5	G 1/8"		RKH-G 1/8"-4445	*	RKH-G 1/8"-4446	*	RKH-G 1/8"-4423	92,00
		6	G 1/4"		RKH-G 1/4"-4445	*	RKH-G 1/4"-4446	*	RKH-G 1/4"-4423	92,00
		10	G 3/8"		RKH-G 3/8"-4445	*	RKH-G 3/8"-4446	*	RKH-G 3/8"-4423	94,25
		13	G 1/2"		RKH-G 1/2"-4445	*	RKH-G 1/2"-4446	*	RKH-G 1/2"-4423	101,55
		16	G 5/8"		RKH-G 5/8"-4445	*	RKH-G 5/8"-4446	*	RKH-G 5/8"-4423	*
		20	G 3/4"		RKH-G 3/4"-4445	*	RKH-G 3/4"-4446	*	RKH-G 3/4"-4423	206,40
		24	G 1"		RKH-G 1"-4445	*	RKH-G 1"-4446	*	RKH-G 1"-4423	225,75
		32	G 1 1/4"		RKH-G 1 1/4"-4445	*	RKH-G 1 1/4"-4446	*	RKH-G 1 1/4"-4423	409,50
		38	G 1 1/2"		RKH-G 1 1/2"-4445	*	RKH-G 1 1/2"-4446	*	RKH-G 1 1/2"-4423	531,70
48	G 2"		RKH-G 2"-4445	*	RKH-G 2"-4446	*	RKH-G 2"-4423	639,70		
02 • NPT-Innengewinde • ANSI B 2.1 • <i>NPT Female Thread</i> • <i>ANSI B 2.1</i>		5	1/8"-27 NPT		RKH-1/8"-NPT-4445	*	RKH-1/8"-NPT-4446	*	RKH-1/8"-NPT-4423	99,45
		6	1/4"-18 NPT		RKH-1/4"-NPT-4445	*	RKH-1/4"-NPT-4446	*	RKH-1/4"-NPT-4423	99,45
		10	3/8"-18 NPT		RKH-3/8"-NPT-4445	*	RKH-3/8"-NPT-4446	*	RKH-3/8"-NPT-4423	102,05
		13	1/2"-14 NPT		RKH-1/2"-NPT-4445	*	RKH-1/2"-NPT-4446	*	RKH-1/2"-NPT-4423	109,95
		20	3/4"-14 NPT		RKH-3/4"-NPT-4445	*	RKH-3/4"-NPT-4446	*	RKH-3/4"-NPT-4423	223,31
		24	1"-11,5 NPT		RKH-1"-NPT-4445	*	RKH-1"-NPT-4446	*	RKH-1"-NPT-4423	244,23
		32	1 1/4"-11,5 NPT		RKH-1 1/4"-NPT-4445	*	RKH-1 1/4"-NPT-4446	*	RKH-1 1/4"-NPT-4423	443,15
		38	1 1/2"-11,5 NPT		RKH-1 1/2"-NPT-4445	*	RKH-1 1/2"-NPT-4446	*	RKH-1 1/2"-NPT-4423	558,30
48	2"-11,5 NPT		RKH-2"-NPT-4445	*	RKH-2"-NPT-4446	*	RKH-2"-NPT-4423	671,65		
03 • Rohrverschraubung • Leichte Reihe DIN 2353 • <i>For Compression Fitting</i> • <i>Light Series DIN 2353</i>		5	M 12 x 1,5	6	RKH-06-L-4445	*	RKH-06-L-4446	*	RKH-06-L-4423	94,70
		6	M 14 x 1,5	8	RKH-08-L-4445	*	RKH-08-L-4446	*	RKH-08-L-4423	94,70
		8	M 16 x 1,5	10	RKH-10-L-4445	*	RKH-10-L-4446	*	RKH-10-L-4423	92,00
		10	M 18 x 1,5	12	RKH-12-L-4445	*	RKH-12-L-4446	*	RKH-12-L-4423	94,25
		13	M 22 x 1,5	15	RKH-15-L-4445	*	RKH-15-L-4446	*	RKH-15-L-4423	101,55
		13	M 26 x 1,5	18	RKH-18-L-4445	*	RKH-18-L-4446	*	RKH-18-L-4423	101,55
		20	M 30 x 2	22	RKH-22-L-4445	*	RKH-22-L-4446	*	RKH-22-L-4423	206,40
		24	M 36 x 2	28	RKH-28-L-4445	*	RKH-28-L-4446	*	RKH-28-L-4423	225,75
		32	M 45 x 2	35	RKH-35-L-4445	*	RKH-35-L-4446	*	RKH-35-L-4423	409,50
38	M 52 x 2	42	RKH-42-L-4445	*	RKH-42-L-4446	*	RKH-42-L-4423	531,70		
04 • Rohrverschraubung • Schwere Reihe DIN 2353 • <i>For Compression Fitting</i> • <i>Heavy Series DIN 2353</i>		5	M 14 x 1,5	6	RKH-06-S-4445	*	RKH-06-S-4446	*	RKH-06-S-4423	94,70
		5	M 16 x 1,5	8	RKH-08-S-4445	*	RKH-08-S-4446	*	RKH-08-S-4423	94,70
		6	M 18 x 1,5	10	RKH-10-S-4445	*	RKH-10-S-4446	*	RKH-10-S-4423	92,00
		8	M 20 x 1,5	12	RKH-12-S-4445	*	RKH-12-S-4446	*	RKH-12-S-4423	92,00
		10	M 22 x 1,5	14	RKH-14-S-4445	*	RKH-14-S-4446	*	RKH-14-S-4423	97,20
		13	M 24 x 1,5	16	RKH-16-S-4445	*	RKH-16-S-4446	*	RKH-16-S-4423	101,55
		13	M 30 x 2	20	RKH-20-S-4445	*	RKH-20-S-4446	*	RKH-20-S-4423	101,55
		20	M 36 x 2	25	RKH-25-S-4445	*	RKH-25-S-4446	*	RKH-25-S-4423	206,40
		24	M 42 x 2	30	RKH-30-S-4445	*	RKH-30-S-4446	*	RKH-30-S-4423	225,75
		32	M 52 x 2	38	RKH-38-S-4445	*	RKH-38-S-4446	*	RKH-38-S-4423	409,50

* Preise auf Anfrage / * Prices on request

*Max. zulässige Druckstufen (PB) entnehmen Sie bitte den Angaben der Schneidringverschraubungen.

*Max. allowed pressure (PB) see at the data from the compression couplings.

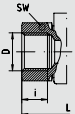
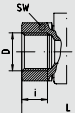
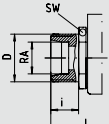
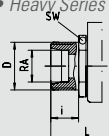
Anschlussart Connection	DN	D	RA	L	i	SW	Gewicht Weight
							kg
01 • Rohrgewinde • DIN ISO 228 • BSP Female Thread • DIN ISO 228 	5	G 1/8"		69	9	22	0,35
	6	G 1/4"		69	12	22	0,35
	10	G 3/8"		73	12	27	0,5
	13	G 1/2"		85	14	30	0,65
	16	G 5/8"		84	14	32	0,75
	20	G 3/4"		96	17	41	1,5
	24	G 1"		113	19	46	1,8
	32	G 1 1/4"		110	20	60	3,8
	38	G 1 1/2"		120	22	70	6,1
	48	G 2"		140	28	85	9,1
02 • NPT-Innengewinde • ANSI B 2.1 • NPT Female Thread • ANSI B 2.1 	5	1/8"-27 NPT		69	12	22	0,35
	6	1/4"-18 NPT		69	17	22	0,35
	10	3/8"-18 NPT		73	17	27	0,5
	13	1/2"-14 NPT		92	22	30	0,65
	20	3/4"-14 NPT		97	23	41	1,5
	24	1" -11,5 NPT		113	27	46	1,8
	32	1 1/4"-11,5 NPT		115	28	60	3,8
	38	1 1/2"-11,5 NPT		135	28	70	6,1
	48	2" -11,5 NPT		140	30	85	9,1
03 • Rohrverschraubung • Leichte Reihe DIN 2353 • For Compression Fitting • Light Series DIN 2353 	5	M 12 x 1,5	6	67	10	22	0,3
	6	M 14 x 1,5	8	67	10	22	0,3
	8	M 16 x 1,5	10	71	11	22	0,3
	10	M 18 x 1,5	12	75	11	27	0,5
	13	M 22 x 1,5	15	84	12	30	0,6
	13	M 26 x 1,5	18	84	12	30	0,6
	20	M 30 x 2	22	102	14	41	1,5
	24	M 36 x 2	28	108	14	46	1,8
	32	M 45 x 2	35	128	16	60	3,6
	38	M 52 x 2	42	133	16	70	5,9
04 • Rohrverschraubung • Schwere Reihe DIN 2353 • For Compression Fitting • Heavy Series DIN 2353 	5	M 14 x 1,5	6	73	12	22	0,3
	5	M 16 x 1,5	8	73	12	22	0,35
	6	M 18 x 1,5	10	73	12	22	0,35
	8	M 20 x 1,5	12	76	12	22	0,35
	10	M 22 x 1,5	14	84	14	27	0,5
	13	M 24 x 1,5	16	87	14	30	0,6
	13	M 30 x 2	20	91	16	30	0,65
	20	M 36 x 2	25	110	18	41	1,5
	24	M 42 x 2	30	120	20	46	1,9
	32	M 52 x 2	38	140	22	60	3,7

DREIWEGE-UMSCHALT-KUGELHÄHNE - BK 3

THREE-WAY BALL VALVES - BK 3



EDELSTAHL / STAINLESS STEEL
VERBINDUNGSTECHNIK
FLUID CONNECTORS



Dreiwege-Umschalt-Kugelhähne - BK 3

L- oder T-Bohrung

Serie 100

DN 4 bis DN 50

Gehäuse, Kugel und Schaltwelle, V4a (AISI 316)

Unsere Kugelhähne werden einzeln einer Prüfung auf Festigkeit, Dichtheit und besonderen geltenden Richtlinien unterzogen.

Abnahmeprüfzeugnis 3.1 B oder 3.1 C nach DIN EN 10204 kann auf Anfrage, gegen Berechnung, mitgeliefert werden.

Three-Way Ball Valves - BK 3

L- or T-Bore

Series 100

DN 4 to DN 50

Body, Ball and Stem, V4a (AISI 316)

Each PH ball valve is subject to an inspection for resistance, sealing and special characteristics.

Inspection control certificates 3.1 B or 3.1 C per DIN EN 10204 can be supplied on request against invoice.

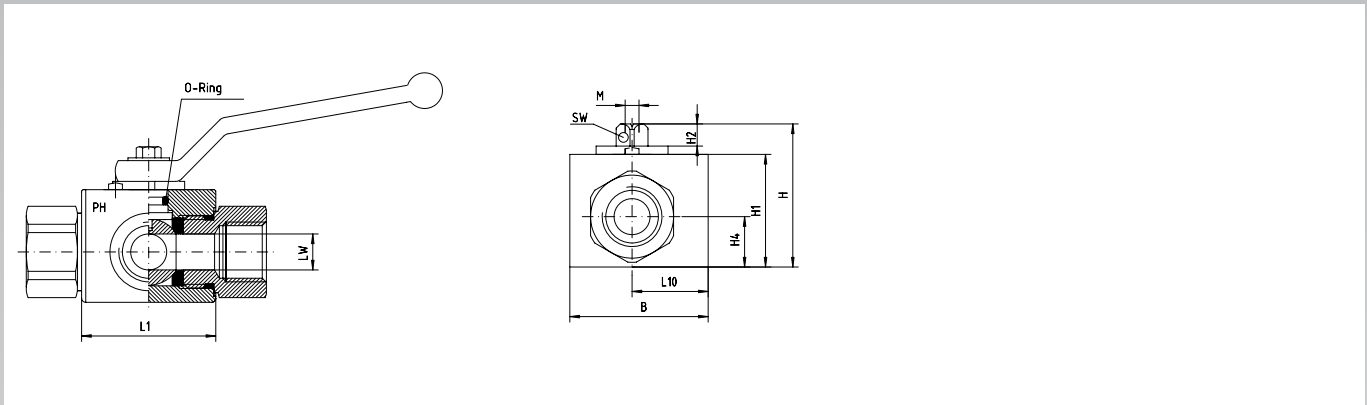

DN mm	PB1 bar	L1 mm	B mm	H mm	H1 mm	H2 mm	H4 mm	M mm	SW \varnothing mm
4	400	35	40	46,5	35	8,0	16,0	M 5	9
6	400	35	40	46,5	35	8,0	16,0	M 5	9
8	400	35	40	46,5	35	8,0	16,0	M 5	9
10	400	42	45	51,5	40	8,0	18,0	M 5	9
13	400	47	50	56,0	40	8,0	17,0	M 5	9
20	320	61	65	73,5	57	12,0	24,5	M 6	14
25	350	63	80	81,5	65	12,0	30,0	M 6	14
32	350	78	100	99,0	80	13,5	38,0	M 8	17
40	250	85	105	109,0	90	13,5	42,0	M 8	17
50	250	100	120	139,0	120	13,5	62,0	M 8	17

Der angegebene Betriebsdruck PB ist nur gültig für die Standardausführung 4423.
The indicated working pressure PB is only valid for the standard version 4423.

Gehäusemaße gültig für alle Kombinationen.
Body dimensions are for all the combinations.

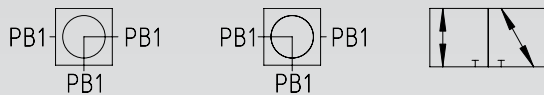

Typ LA: L-Bohrung 0° - 90° allseitig druckbeaufschlagbar
Type LA: L-bore 0° - 90° pressured from all ports possible

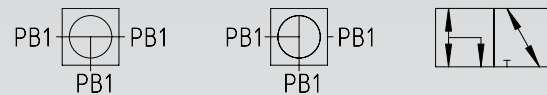

Typ TA: T-Bohrung 0° - 90° allseitig druckbeaufschlagbar
Type TA: T-bore 0° - 90° pressured from all ports possible

BESTELLZEICHEN - WERKSTOFFKOMBINATIONEN

ORDER-CODE - COMBINATION OF MATERIALS



Maßänderungen vorbehalten.

Measurements subject to alteration.

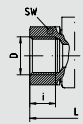
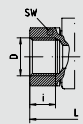
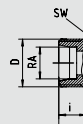
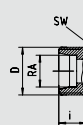
Gehäuseteile Kugel Schaltwelle Kugeldichtung Schaltwellendichtung		Body Ball Stem Ball Sealing Stem Sealing				V4a (AISI 316) V4a (AISI 316) V4a (AISI 316) PTFE (bis/to 100 bar) FKM		V4a (AISI 316) V4a (AISI 316) V4a (AISI 316) POM NBR	
						Korrosive Medien <i>Corrosive Media</i>		Hydraulik - Standardausführung <i>Hydraulics - Standard Version</i>	
						-20°C bis/to 100°C		-20°C bis/to 100°C	
Anschlussart <i>Connection</i>					Bestellzeichen <i>Order-Code</i>	Brutto-Preis <i>Gross-Price</i> Euro (€)	Bestellzeichen <i>Order-Code</i>	Brutto-Preis <i>Gross-Price</i> Euro (€)	
	DN	LW	D	RA					
01 • Rohrgewinde • DIN ISO 228 • <i>BSP Female Thread</i> • <i>DIN ISO 228</i> 	4	5,0	G 1/8"		BK3-G 1/8"-4445-L	*	BK3-G 1/8"-4423-LA	*	
	6	6,0	G 1/4"		BK3-G 1/4"-4445-L	*	BK3-G 1/4"-4423-LA	324,00	
	10	9,0	G 3/8"		BK3-G 3/8"-4445-L	*	BK3-G 3/8"-4423-LA	345,60	
	13	11,5	G 1/2"		BK3-G 1/2"-4445-L	*	BK3-G 1/2"-4423-LA	373,85	
	20	18,0	G 3/4"		BK3-G 3/4"-4445-L	*	BK3-G 3/4"-4423-LA	578,20	
	25	22,0	G 1"		BK3-G 1"-4445-L	*	BK3-G 1"-4423-LA	639,70	
	32	30,0	G 1 1/4"		BK3-G 1 1/4"-4445-L	*	BK3-G 1 1/4"-4423-LA	1254,45	
	40	35,0	G 1 1/2"		BK3-G 1 1/2"-4445-L	*	BK3-G 1 1/2"-4423-LA	1415,65	
	50	44,0	G 2"		BK3-G 2"-4445-L	*	BK3-G 2"-4423-LA	*	
02 • NPT-Innengewinde • ANSI B 2.1 • <i>NPT Female Thread</i> • <i>ANSI B 2.1</i> 	4	5,0	1/8"-27 NPT		BK3-1/8"-NPT-4445-L	*	BK3-1/8"-NPT-4423-LA	*	
	6	6,0	1/4"-18 NPT		BK3-1/4"-NPT-4445-L	*	BK3-1/4"-NPT-4423-LA	*	
	10	9,0	3/8"-18 NPT		BK3-3/8"-NPT-4445-L	*	BK3-3/8"-NPT-4423-LA	*	
	13	11,5	1/2"-14 NPT		BK3-1/2"-NPT-4445-L	*	BK3-1/2"-NPT-4423-LA	*	
	20	18,0	3/4"-14 NPT		BK3-3/4"-NPT-4445-L	*	BK3-3/4"-NPT-4423-LA	*	
	25	22,0	1"-11,5 NPT		BK3-1"-NPT-4445-L	*	BK3-1"-NPT-4423-LA	*	
	32	30,0	1 1/4"-11,5 NPT		BK3-1 1/4"-NPT-4445-L	*	BK3-1 1/4"-NPT-4423-LA	*	
	40	35,0	1 1/2"-11,5 NPT		BK3-1 1/2"-NPT-4445-L	*	BK3-1 1/2"-NPT-4423-LA	*	
	50	44,0	2"-11,5 NPT		BK3-2"-NPT-4445-L	*	BK3-2"-NPT-4423-LA	*	
03 • Rohrverschraubung • Leichte Reihe DIN 2353 • <i>For Compression Fitting</i> • <i>Light Series DIN 2353</i> 	4	5,0	M 12 x 1,5	6	BK3-6-L-4445-L	*	BK3-6-L-4423-LA	*	
	6	6,0	M 14 x 1,5	8	BK3-8-L-4445-L	*	BK3-8-L-4423-LA	*	
	8	7,0	M 16 x 1,5	10	BK3-10-L-4445-L	*	BK3-10-L-4423-LA	*	
	10	9,0	M 18 x 1,5	12	BK3-12-L-4445-L	*	BK3-12-L-4423-LA	*	
	13	11,5	M 22 x 1,5	15	BK3-15-L-4445-L	*	BK3-15-L-4423-LA	*	
	13	11,5	M 26 x 1,5	18	BK3-18-L-4445-L	*	BK3-18-L-4423-LA	*	
	20	18,0	M 30 x 2	22	BK3-22-L-4445-L	*	BK3-22-L-4423-LA	*	
	25	18,0	M 36 x 2	28	BK3-28-L-4445-L	*	BK3-28-L-4423-LA	*	
	32	30,0	M 45 x 2	35	BK3-35-L-4445-L	*	BK3-35-L-4423-LA	*	
04 • Rohrverschraubung • Schwere Reihe DIN 2353 • <i>For Compression Fitting</i> • <i>Heavy Series DIN 2353</i> 	4	5,0	M 14 x 1,5	6	BK3-6-S-4445-L	*	BK3-6-S-4423-LA	*	
	4	5,0	M 16 x 1,5	8	BK3-8-S-4445-L	*	BK3-8-S-4423-LA	*	
	6	6,0	M 18 x 1,5	10	BK3-10-S-4445-L	*	BK3-10-S-4423-LA	*	
	8	7,0	M 20 x 1,5	12	BK3-12-S-4445-L	*	BK3-12-S-4423-LA	*	
	10	9,0	M 22 x 1,5	14	BK3-14-S-4445-L	*	BK3-14-S-4423-LA	*	
	13	11,5	M 24 x 1,5	16	BK3-16-S-4445-L	*	BK3-16-S-4423-LA	*	
	13	11,5	M 30 x 2	20	BK3-20-S-4445-L	*	BK3-20-S-4423-LA	*	
	20	18,0	M 36 x 2	25	BK3-25-S-4445-L	*	BK3-25-S-4423-LA	*	
	25	22,0	M 42 x 2	30	BK3-30-S-4445-L	*	BK3-30-S-4423-LA	*	
	32	30,0	M 52 x 2	38	BK3-38-S-4445-L	*	BK3-38-S-4423-LA	*	

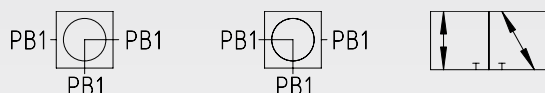

Typ LA: L-Bohrung 0° - 90° allseitig druckbeaufschlagbar
 Type LA: L-bore 0° - 90° pressured from all ports possible

* Preise auf Anfrage / * Prices on request



Maßänderungen vorbehalten.

Measurements subject to alteration.

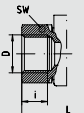
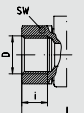
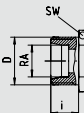
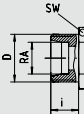
Gehäuseteile Kugel Schaltwelle Kugeldichtung Schaltwellendichtung		Body Ball Stem Ball Sealing Stem Sealing				V4a (AISI 316) V4a (AISI 316) V4a (AISI 316) PTFE (bis/to 100 bar) FKM	V4a (AISI 316) V4a (AISI 316) V4a (AISI 316) POM NBR	
						Korrosive Medien <i>Corrosive Media</i>	Hydraulik - Standardausführung <i>Hydraulics - Standard Version</i>	
						-20°C bis/to 100°C	-20°C bis/to 100°C	
Anschlussart <i>Connection</i>	DN	LW	D	RA	Bestellzeichen <i>Order-Code</i>	Brutto-Preis	Bestellzeichen	Brutto-Preis
						Gross-Price Euro (€)	Order-Code	Gross-Price Euro (€)
01 • Rohrgewinde • DIN ISO 228 • <i>BSP Female Thread</i> • <i>DIN ISO 228</i> 	4	5,0	G 1/8"		BK3-G 1/8"-4445-T	*	BK3-G 1/8"-4423-TA	*
	6	6,0	G 1/4"		BK3-G 1/4"-4445-T	*	BK3-G 1/4"-4423-TA	324,00
	10	9,0	G 3/8"		BK3-G 3/8"-4445-T	*	BK3-G 3/8"-4423-TA	345,60
	13	11,5	G 1/2"		BK3-G 1/2"-4445-T	*	BK3-G 1/2"-4423-TA	373,85
	20	18,0	G 3/4"		BK3-G 3/4"-4445-T	*	BK3-G 3/4"-4423-TA	578,20
	25	22,0	G 1"		BK3-G 1"-4445-T	*	BK3-G 1"-4423-TA	639,70
	32	30,0	G 1 1/4"		BK3-G 1 1/4"-4445-T	*	BK3-G 1 1/4"-4423-TA	1254,45
	40	35,0	G 1 1/2"		BK3-G 1 1/2"-4445-T	*	BK3-G 1 1/2"-4423-TA	1415,65
	50	44,0	G 2"		BK3-G 2"-4445-T	*	BK3-G 2"-4423-TA	*
02 • NPT-Innengewinde • ANSI B 2.1 • <i>NPT Female Thread</i> • <i>ANSI B 2.1</i> 	4	5,0	1/8"-27-NPT		BK3-1/8"-NPT-4445-T	*	BK3-1/8"-NPT-4423-TA	*
	6	6,0	1/4"-18 NPT		BK3-1/4"-NPT-4445-T	*	BK3-1/4"-NPT-4423-TA	*
	10	9,0	3/8"-18 NPT		BK3-3/8"-NPT-4445-T	*	BK3-3/8"-NPT-4423-TA	*
	13	11,5	1/2"-14 NPT		BK3-1/2"-NPT-4445-T	*	BK3-1/2"-NPT-4423-TA	*
	20	18,0	3/4"-14 NPT		BK3-3/4"-NPT-4445-T	*	BK3-3/4"-NPT-4423-TA	*
	25	22,0	1"-11,5 NPT		BK3-1"-NPT-4445-T	*	BK3-1"-NPT-4423-TA	*
	32	30,0	1 1/4"-11,5 NPT		BK3-1 1/4"-NPT-4445-T	*	BK3-1 1/4"-NPT-4423-TA	*
	40	35,0	1 1/2"-11,5 NPT		BK3-1 1/2"-NPT-4445-T	*	BK3-1 1/2"-NPT-4423-TA	*
	50	44,0	2"-11,5 NPT		BK3-2"-NPT-4445-T	*	BK3-2"-NPT-4423-TA	*
03 • Rohrverschraubung • Leichte Reihe DIN 2353 • <i>For Compression Fitting</i> • <i>Light Series DIN 2353</i> 	4	5,0	M 12 x 1,5	6	BK3-6-L-4445-T	*	BK3-6-L-4423-TA	*
	6	6,0	M 14 x 1,5	8	BK3-8-L-4445-T	*	BK3-8-L-4423-TA	*
	8	7,0	M 16 x 1,5	10	BK3-10-L-4445-T	*	BK3-10-L-4423-TA	*
	10	9,0	M 18 x 1,5	12	BK3-12-L-4445-T	*	BK3-12-L-4423-TA	*
	13	11,5	M 22 x 1,5	15	BK3-15-L-4445-T	*	BK3-15-L-4423-TA	*
	13	11,5	M 26 x 1,5	18	BK3-18-L-4445-T	*	BK3-18-L-4423-TA	*
	20	18,0	M 30 x 2	22	BK3-22-L-4445-T	*	BK3-22-L-4423-TA	*
	25	22,0	M 36 x 2	28	BK3-28-L-4445-T	*	BK3-28-L-4423-TA	*
	32	30,0	M 45 x 2	35	BK3-35-L-4445-T	*	BK3-35-L-4423-TA	*
04 • Rohrverschraubung • Schwere Reihe DIN 2353 • <i>For Compression Fitting</i> • <i>Heavy Series DIN 2353</i> 	4	5,0	M 14 x 1,5	6	BK3-6-S-4445-T	*	BK3-6-S-4423-TA	*
	4	5,0	M 16 x 1,5	8	BK3-8-S-4445-T	*	BK3-8-S-4423-TA	*
	6	6,0	M 18 x 1,5	10	BK3-10-S-4445-T	*	BK3-10-S-4423-TA	*
	8	7,0	M 20 x 1,5	12	BK3-12-S-4445-T	*	BK3-12-S-4423-TA	*
	10	9,0	M 22 x 1,5	14	BK3-14-S-4445-T	*	BK3-14-S-4423-TA	*
	13	11,5	M 24 x 1,5	16	BK3-16-S-4445-T	*	BK3-16-S-4423-TA	*
	13	11,5	M 30 x 2	20	BK3-20-S-4445-T	*	BK3-20-S-4423-TA	*
	20	18,0	M 36 x 2	25	BK3-25-S-4445-T	*	BK3-25-S-4423-TA	*
	25	22,0	M 42 x 2	30	BK3-30-S-4445-T	*	BK3-30-S-4423-TA	*
	32	30,0	M 52 x 2	38	BK3-38-S-4445-T	*	BK3-38-S-4423-TA	*

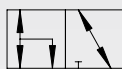
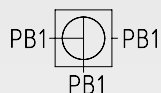
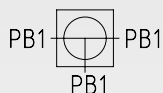

Typ TA: T-Bohrung 0° - 90° allseitig druckbeaufschlagbar
Type TA: T-bore 0° - 90° pressured from all ports possible

* Preise auf Anfrage / * Prices on request

DREIWEGE-UMSCHALT-KUGELHÄHNE - BK 3

THREE-WAY BALL VALVES - BK 3



EDELSTAHL / STAINLESS STEEL
VERBINDUNGSTECHNIK
FLUID CONNECTORS

*Max. zulässige Druckstufen (PB) entnehmen Sie bitte den Angaben der Schneidringverschraubungen.

*Max. allowed pressure (PB) see at the data from the compression couplings.

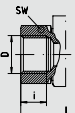
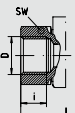
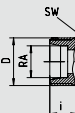
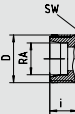
Anschlussart Connection	DN	LW	D	RA	Ca. Maße Approx. Dimensions			
					L	L10	i	SW
01 • Rohrgewinde • DIN ISO 228 • BSP Female Thread • DIN ISO 228 	4	5,0	G 1/8"		69	26,0	9	22
	6	6,0	G 1/4"		69	26,0	12	22
	10	9,0	G 3/8"		73	28,0	12	27
	13	11,5	G 1/2"		85	32,0	14	30
	20	18,0	G 3/4"		96	40,5	17	41
	25	22,0	G 1"		113	51,0	19	46
	32	30,0	G 1 1/4"		110	62,0	20	60
	40	35,0	G 1 1/2"		120	65,0	24	70
	50	44,0	G 2"		140	72,0	28	85
02 • NPT-Innengewinde • ANSI B 2.1 • NPT Female Thread • ANSI B 2.1 	4	5,0	1/8"-27 NPT		69	26,0	12	22
	6	6,0	1/4"-18 NPT		69	26,0	17	22
	10	9,0	3/8"-18 NPT		73	28,0	17	27
	13	11,5	1/2"-14 NPT		92	32,0	22	30
	20	18,0	3/4"-14 NPT		97	40,5	23	41
	25	22,0	1"-11,5 NPT		113	51,0	27	46
	32	30,0	1 1/4"-11,5 NPT		115	62,0	28	60
	40	35,0	1 1/2"-11,5 NPT		138	65,0	28	70
	50	44,0	2"-11,5 NPT		140	72,0	30	85
03* • Rohrverschraubung • Leichte Reihe DIN 2353 • For Compression Fitting • Light Series DIN 2353 	4	5,0	M 12 x 1,5	6	67	41,5	10	22
	6	6,0	M 14 x 1,5	8	67	41,5	10	22
	8	7,0	M 16 x 1,5	10	71	41,5	11	22
	10	9,0	M 18 x 1,5	12	75	44,5	11	27
	13	11,5	M 22 x 1,5	15	84	50,0	12	30
	13	11,5	M 26 x 1,5	18	84	50,0	12	32
	20	18,0	M 30 x 2	22	102	60,5	14	41
	25	22,0	M 36 x 2	28	108	72,0	14	46
	32	30,0	M 45 x 2	35	128	86,0	16	60
04* • Rohrverschraubung • Schwere Reihe DIN 2353 • For Compression Fitting • Heavy Series DIN 2353 	4	5,0	M 14 x 1,5	6				
	4	5,0	M 16 x 1,5	8	73	44,5	12	22
	6	6,0	M 18 x 1,5	10	73	44,5	12	22
	8	7,0	M 20 x 1,5	12	77	46,0	12	22
	10	9,0	M 22 x 1,5	14	84	48,5	14	27
	13	11,5	M 24 x 1,5	16	87	51,5	14	30
	13	11,5	M 30 x 2	20	91	51,5	16	32
	20	18,0	M 36 x 2	25	110	64,5	18	41
	25	22,0	M 42 x 2	30	120	78,0	20	46
32	30,0	M 52 x 2	38	140	92,0	22	60	

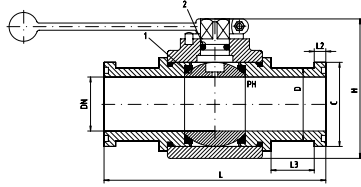

Mit Flansch nach SAE J 518 / DIN 6162
3000 P.S.I. + 6000 P.S.I.
Für SAE-Flanschhälften, Rubrik 2.54
1 = Kugeldichtung - POM
2 = Schaltwellendichtung - NBR

With Flange to SAE J 518 / DIN 6162
3000 P.S.I. + 6000 P.S.I.
For SAE-Split Flange Halves, Category 2.54
1 = Ball Sealing - POM
2 = Stem Sealing - NBR

Druck Pressure PB	DN	Ca. Maße Approx. Dimensions						Bestellzeichen Order-Code	Brutto-Preis Gross-Price Euro (€)
		C	D	H	L	L 2	L 3		
315	13	30,2	24	51,0	151,0	6,7	35	FKH-3000-1/2"-4423	283,30
315	20	38,1	32	73,0	162,0	6,7	35	FKH-3000-3/4"-4423	411,20
315	24	44,4	38	76,0	178,0	8,0	35	FKH-3000-1"-4423	464,23
250	32	50,8	43	105,0	190,5	8,0	35	FKH-3000-1 1/4"-4423	950,40
200	38	60,3	50	111,4	231,0	8,0	40	FKH-3000-1 1/2"-4423	1109,40
200	48	71,4	62	130,0	232,0	9,5	45	FKH-3000-2"-4423	1310,45
400	13	31,7	24	51,0	151,0	7,7	35	FKH-6000-1/2"-4423	283,30
400	20	41,3	32	73,0	174,0	8,8	40	FKH-6000-3/4"-4423	411,20
400	24	47,6	38	76,0	198,0	9,5	40	FKH-6000-1"-4423	464,23
400	32	54,0	44	105,0	223,0	10,3	45	FKH-6000-1 1/4"-4423	950,40
400	38	63,5	51	111,4	281,0	12,6	70	FKH-6000-1 1/2"-4423	1109,40
400	48	79,4	67	130,0	316,0	12,6	80	FKH-6000-2"-4423	1310,45

NIEDERDRUCK-KUGELHÄHNE

LOW PRESSURE BALL VALVES

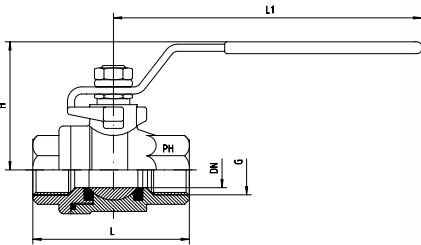

Rohrinnengewinde: DIN / ISO 228

Zweiteilig - 1.4408

Volle Bohrung

Dichtungen: Kugel + Schaltwelle = PTFE (-20°C bis +180°C)

Bei höheren Temperaturen beachten Sie bitte das Druck- / Temperaturdiagramm.

BSP Female Thread: DIN / ISO 228

Two-piece - AISI 316

Full-Port

Sealings: Ball + Stem = PTFE (-20°C to +180°C)

At higher temperatures please note the pressure / temperature diagram.

Größe Size	DN	Druck Pressure PB	Ca. Maße Approx. Dimensions				Bestellzeichen Order-Code	Brutto-Preis Gross-Price Euro (€)
			G	H	L	L1		
1/8"	8,5	63	1/8"	50	55,0	100,0	KH-G 1/8"	18,35
1/4"	11,5	63	1/4"	50	55,0	100,0	KH-G 1/4"	18,35
3/8"	12,5	63	3/8"	50	55,0	100,0	KH-G 3/8"	18,35
1/2"	15,0	63	1/2"	60	65,0	130,0	KH-G 1/2"	21,40
3/4"	20,0	63	3/4"	64	72,0	130,0	KH-G 3/4"	26,85
1"	25,0	63	1"	71	84,0	165,0	KH-G 1"	38,00
1 1/4"	32,0	63	1 1/4"	78	94,0	165,0	KH-G 1 1/4"	49,70
1 1/2"	38,0	63	1 1/2"	86	110,0	190,0	KH-G 1 1/2"	73,50
2"	50,0	63	2"	95	126,0	190,0	KH-G 2"	96,75
2 1/2"	65,0	40	2 1/2"	130	161,0	250,0	KH-G 2 1/2"	242,00
3"	80,0	40	3"	148	178,0	250,0	KH-G 3"	326,85

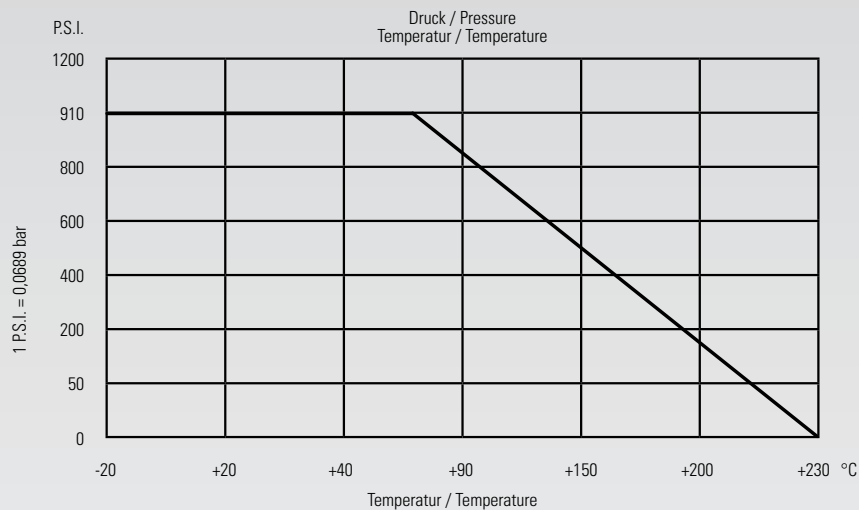

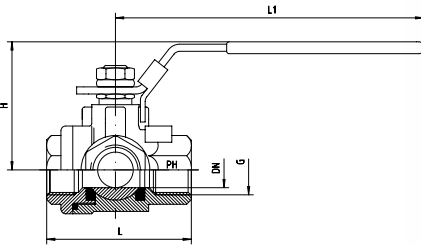

Rohrinnengewinde: DIN / ISO 228

3-Wege - 1.4408

L-Bohrung

Dichtungen: Kugel + Schaltwelle = PTFE (-20°C bis +180°C)

Bei höheren Temperaturen beachten Sie bitte das Druck- / Temperaturdiagramm.

BSP Female Thread: DIN / ISO 228

3-Way - AISI 316

L-Port

Sealings: Ball + Stem = PTFE (-20°C to +180°C)

At higher temperatures please note the pressure / temperature diagram.

Größe Size	DN	Druck Pressure PB	Ca. Maße Approx. Dimensions				Bestellzeichen Order-Code	Brutto-Preis Gross-Price Euro (€)
			G	H	L	L1		
1/4"	11,2	63	1/4"	50	68	97	KH-G 1/4"-3-W-L	55,20
3/8"	11,2	63	3/8"	50	68	97	KH-G 3/8"-3-W-L	55,20
1/2"	12,7	63	1/2"	50	68	97	KH-G 1/2"-3-W-L	59,55
3/4"	16,0	63	3/4"	64	83	127	KH-G 3/4"-3-W-L	72,05
1"	20,0	63	1"	66	90	127	KH-G 1"-3-W-L	98,30
1 1/4"	25,0	63	1 1/4"	80	97	145	KH-G 1 1/4"-3-W-L	132,95
1 1/2"	32,0	63	1 1/2"	83	114	145	KH-G 1 1/2"-3-W-L	169,45
2"	38,1	63	2"	96	142	205	KH-G 2"-3-W-L	223,25

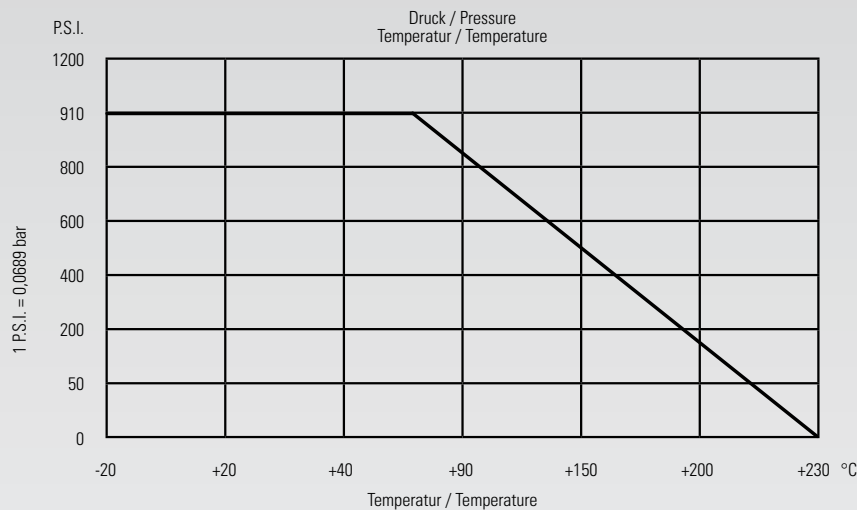

NIEDERDRUCK-KUGELHÄHNE

LOW PRESSURE BALL VALVES

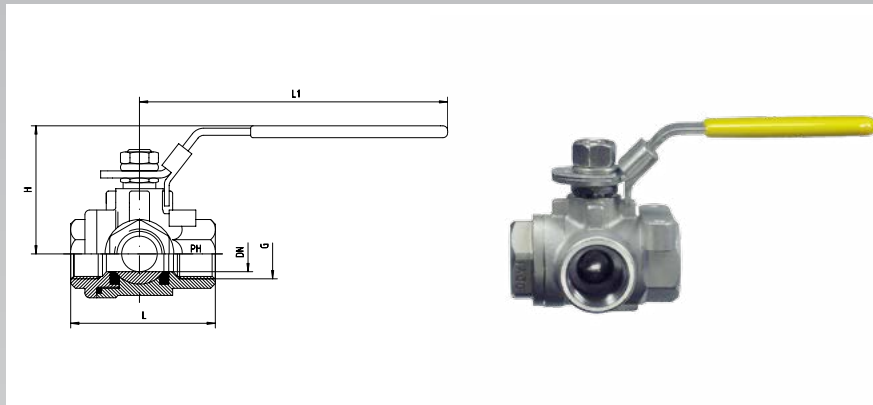

Rohrinnengewinde: DIN / ISO 228
 3-Wege - 1.4408
 T-Bohrung
 Dichtungen: Kugel + Schaltwelle = PTFE (-20°C bis +180°C)
 Bei höheren Temperaturen beachten Sie bitte das Druck- /
 Temperaturdiagramm.

BSP Female Thread: DIN / ISO 228
 3-Way - AISI 316
 T-Port
 Sealings: Ball + Stem = PTFE (-20°C to +180°C)
 At higher temperatures please note the pressure /
 temperature diagram.

Größe Size	DN	Druck Pressure PB	Ca. Maße Approx. Dimensions				Bestellzeichen Order-Code	Brutto-Preis Gross-Price Euro (€)
			G	H	L	L1		
1/4"	11,5	63	1/4"	50	68	97	KH-G 1/4"-3-W-T	115,00
3/8"	12,5	63	3/8"	50	68	97	KH-G 3/8"-3-W-T	115,00
1/2"	12,5	63	1/2"	50	68	97	KH-G 1/2"-3-W-T	115,00
3/4"	15,0	63	3/4"	64	83	127	KH-G 3/4"-3-W-T	130,90
1"	20,0	63	1"	66	90	127	KH-G 1"-3-W-T	171,50
1 1/4"	25,0	63	1 1/4"	80	97	145	KH-G 1 1/4"-3-W-T	240,30
1 1/2"	32,0	63	1 1/2"	83	114	145	KH-G 1 1/2"-3-W-T	305,45
2"	40,0	63	2"	96	142	205	KH-G 2"-3-W-T	376,30

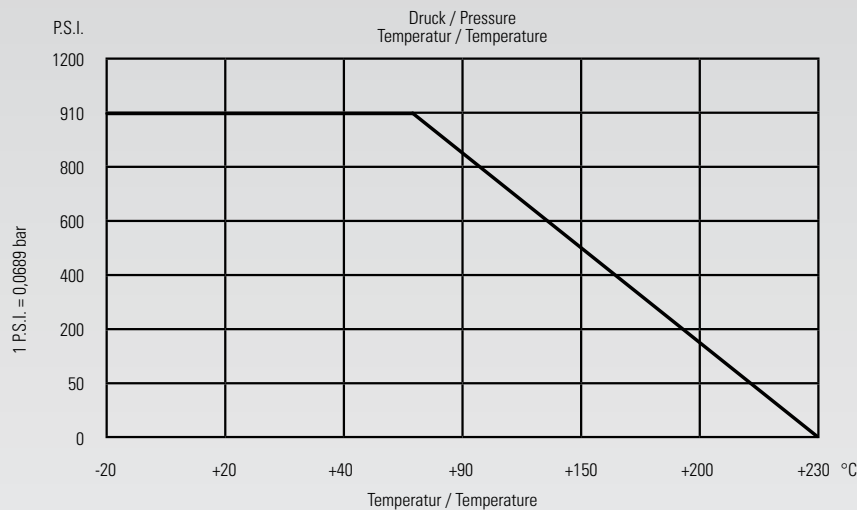

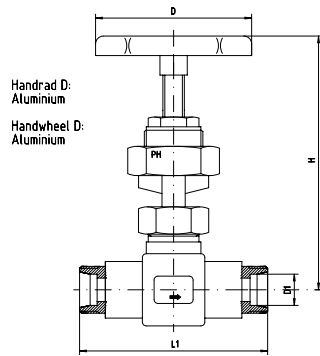

Mit außenliegender Spindel
Anschluß mit 24° Konus für Schneidringverbindung
DIN 2353
Hinweis: Stopfbuchspackung (Graphit) vor erster Inbetriebnahme nachziehen.

With External Threaded Spindle
Connection with 24°-Cone for Compression Couplings
DIN 2353
Note: Adjust stuffing box packing (Graphite) prior to initial working period.

Reihe Series	Druck Pressure PB	Rohr A.D. Tube O.D. D1	Gewinde Thread G	Ca. Maße Approx. Dimensions			Bestellzeichen Order-Code OMD	Preis brutto Price gross Euro (€)
				D	H	L1		
S	400	6	M 14 x 1,5	125	124		HVb-S-06-OMD	286,50
S	400	8	M 16 x 1,5	125	124		HVb-S-08-OMD	287,90
S	400	10	M 18 x 1,5	125	124	80	HVb-S-10-OMD	290,05
S	400	12	M 20 x 1,5	125	124	80	HVb-S-12-OMD	290,65
S	400	14	M 22 x 1,5	125	124		HVb-S-14-OMD	*
S	400	16	M 24 x 1,5	125	124	100	HVb-S-16-OMD	304,10
S	400	20	M 30 x 2	125	124	100	HVb-S-20-OMD	306,25
S	400	25	M 36 x 2	125	153		HVb-S-25-OMD	311,90

Erforderliche Druckabschläge Required Pressure Reductions					
Temperatur Temperature	50°C	100°C	200°C	300°C	400°C
Druckabschlag Pressure Reduction	6%	15%	37%	60%	84%

Zwischenwerte sind zu interpolieren.
Intermediate values are to be interpolated.

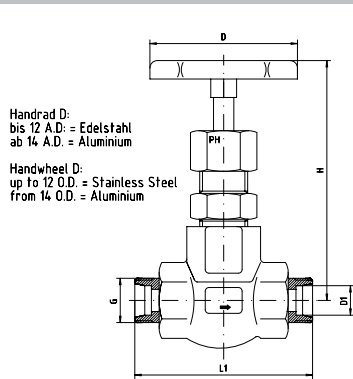

Mit innenliegender Spindel
Anschluß mit 24° Konus für Schneidringverbindung
DIN 2353
Hinweis: Stopfbuchspackung (Graphit) vor erster Inbetriebnahme nachziehen.

With Internal Threaded Spindle
Connection with 24°-Cone for Compression Couplings
DIN 2353
Note: Adjust stuffing box packing (Graphite) prior to initial working period.

Reihe Series	Druck Pressure PB	Rohr A.D. Tube O.D. D1	Gewinde Thread G	Ca. Maße Approx. Dimensions			Bestellzeichen Order-Code OMD	Brutto-Preis Gross-Price Euro (€)
				D	H	L1		
S	630	6	M 14 x 1,5	70	85	65	HVa-S-06-OMD	78,90
S	630	8	M 16 x 1,5	70	85	65	HVa-S-08-OMD	78,90
S	630	10	M 18 x 1,5	70	85	65	HVa-S-10-OMD	78,90
S	630	12	M 20 x 1,5	70	85	65	HVa-S-12-OMD	78,90
S	630	14	M 22 x 1,5	125	110	100	HVa-S-14-OMD	172,20
S	400	16	M 24 x 1,5	125	125	100	HVa-S-16-OMD	166,80
S	400	20	M 30 x 2	125	125	100	HVa-S-20-OMD	251,20
S	400	25	M 36 x 2	125	125	100	HVa-S-25-OMD	251,20
S	250	30	M 42 x 2				HVa-S-30-OMD	469,00
S	250	38	M 52 x 2				HVa-S-38-OMD	634,00

Reihe Series	Druck Pressure PB	Rohr A.D. Tube O.D. D1	Gewinde Thread G	Ca. Maße Approx. Dimensions			Bestellzeichen Order-Code OMD	Brutto-Preis Gross-Price Euro (€)
				D	H	L1		
L	315	6	M 12 x 1,5	70	85	65	HVa-L-06-OMD	78,90
L	315	8	M 14 x 1,5	70	85	65	HVa-L-08-OMD	78,90
L	315	10	M 16 x 1,5	70	85	65	HVa-L-10-OMD	78,90
L	315	12	M 18 x 1,5	70	85	65	HVa-L-12-OMD	78,90
L	315	15	M 22 x 1,5	125	125	100	HVa-L-15-OMD	175,00
L	315	18	M 26 x 1,5	125	125	130	HVa-L-18-OMD	179,40
L	160	22	M 30 x 2	125	125	130	HVa-L-22-OMD	251,20
L	160	28	M 36 x 2	125	125	130	HVa-L-28-OMD	251,20
L	160	35	M 45 x 2				HVa-L-35-OMD	*
L	160	42	M 52 x 2				HVa-L-42-OMD	*

Erforderliche Druckabschläge Required Pressure Reductions					
Temperatur Temperature	50°C	100°C	200°C	300°C	400°C
Druckabschlag Pressure Reduction	6%	15%	37%	60%	84%

Zwischenwerte sind zu interpolieren.
Intermediate values are to be interpolated.

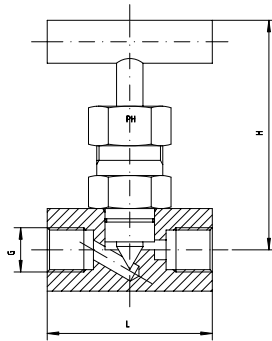

Mit Stopfbuchspackung - PTFE
Rohrinnengewinde DIN / ISO 228
NPT-Innengewinde
Temperatur: -20°C bis +200°C
Hinweis: Stopfbuchspackung (PTFE) vor erster Inbetriebnahme nachziehen.

With Stuffing Box Packing - PTFE
BSP Female Thread DIN / ISO 228
NPT Female Thread
Temperature: -20°C up to +200°C
Note: Adjust stuffing box packing (PTFE) prior to initial working period.

Druck Pressure PN	Gewinde Thread G	Ca. Maße Approx. Dimensions		Bestellzeichen Order-Code	Brutto-Preis Gross-Price Euro (€)
		H	L		
420	1/8" zyl	66,0	59,0	NV-G 1/8"-BSP	49,90
420	1/4" zyl	66,0	59,0	NV-G 1/4"-BSP	49,90
420	3/8" zyl	66,0	59,0	NV-G 3/8"-BSP	49,90
420	1/2" zyl	66,0	65,0	NV-G 1/2"-BSP	61,25
420	3/4" zyl	94,5	70,0	NV-G 3/4"-BSP	107,75
420	1" zyl	94,5	80,0	NV-G 1"-BSP	179,20

Druck Pressure PN	Gewinde Thread G	Ca. Maße Approx. Dimensions		Bestellzeichen Order-Code	Brutto-Preis Gross-Price Euro (€)
		H	L		
420	1/8" NPT	66,0	59,0	NV-1/8"-NPT	*
420	1/4" NPT	66,0	59,0	NV-1/4"-NPT	54,90
420	3/8" NPT	66,0	59,0	NV-3/8"-NPT	54,90
420	1/2" NPT	66,0	65,0	NV-1/2"-NPT	67,40
420	3/4" NPT	94,5	70,0	NV-3/4"-NPT	118,55
420	1" NPT	94,5	80,0	NV-1"-NPT	197,15

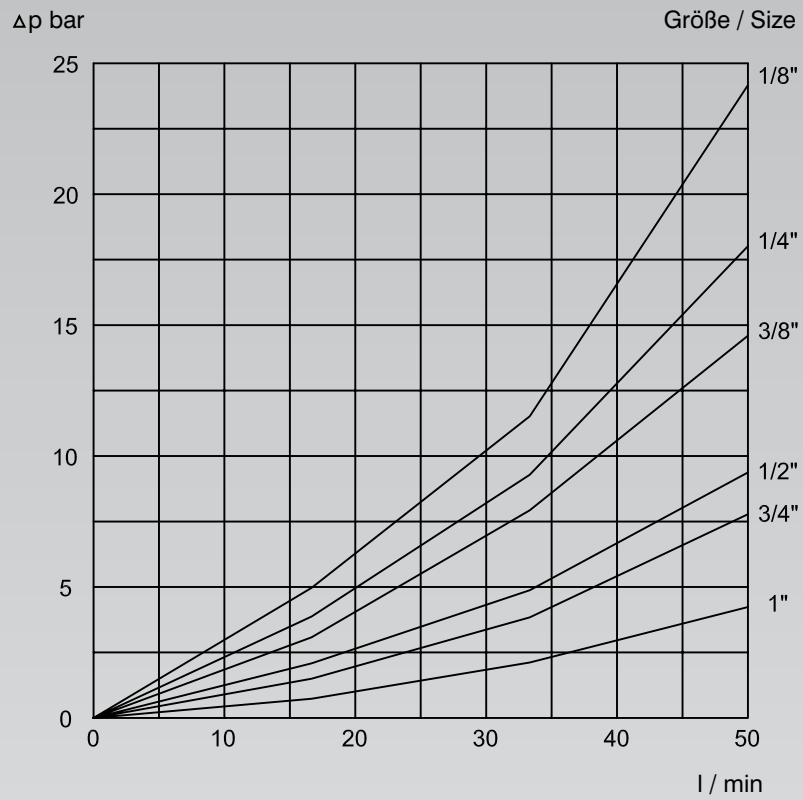



EDELSTAHL / STAINLESS STEEL
VERBINDUNGSTECHNIK
FLUID CONNECTORS







Messanschlüsse Pressure Gauge Connectors



14

MESSANSCHLÜSSE

PRESSURE GAUGE CONNECTORS

	Produktgruppen	Product Groups	Seite Page
	Messanschlüsse	<i>Test Point Pressure Gauge Connectors</i>	14.2
	Gerade Messverschraubungen - GMV - Standard - SC - OMD	<i>Straight Test Point Pressure Gauge Fittings - GMV</i> - Standard - SC - OMD	14.3 14.4 14.5
	Messanschlüsse - VKA - DKO	<i>Test Point Pressure Gauge Connectors - VKA - DKO</i>	14.6
	Hochdruck-Messschläuche - SMS	<i>High Pressure Test Hoses - SMS</i>	14.7
	Manometer-Messanschlüsse - SMA	<i>Gauge Test Adaptors - SMA</i>	14.8
	Manometer-Direktanschlüsse - SMD	<i>Direct Gauge Adaptors - SMD</i>	14.9

Standard = Überwurfmutter blank / Tube nuts are supplied unplated
SC = Überwurfmutter bis Größe 12-S ist ist gleitbeschichtet / Tube nuts until size 12-L are supplied chemical plated
= Überwurfmutter ab Größe 12-S ist mit versilbertem Gewinde / Tube nuts from size 12-S are supplied with silver plated thread
OMD = Verschraubung ohne Überwurfmutter und Schneidring am Außengewinde / Couplings are supplied without nut and cutting ring at male thread

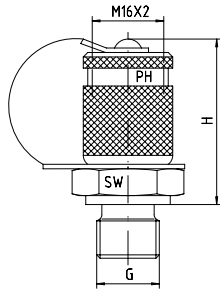

Mit Schraubkupplung M 16 x 2
O-Ring - Viton

With Connection M 16 x 2
O-ring - Viton

Druck Pressure PN	Gewinde Thread G	Ca. Maße Approx. Dimensions		Abdichtung Sealing	Bestellzeichen Order-Code	Brutto-Preis Gross-Price Euro (€)
		H	SW			
630	M 8 x 1	37	17	O-Ring Form A / O-ring Form A	MAS-M 8x1-or	48,06
630	M 10 x 1	37	17	O-Ring Form A / O-ring Form A	MAS-M 10x1-or	48,06
630	M 10 x 1	37	17	Weichdichtung Form C / Soft Sealing Form C	MAS-M 10x1-wd	50,10
630	M 12 x 1,5	37	17	Weichdichtung Form C / Soft Sealing Form C	MAS-M 12x1,5-wd	53,50
630	M 14 x 1,5	37	19	Weichdichtung Form C / Soft Sealing Form C	MAS-M 14x1,5-wd	48,06
630	M 16 x 1,5	37	22	Weichdichtung Form C / Soft Sealing Form C	MAS-M 16x1,5-wd	48,06

Druck Pressure PN	Gewinde Thread G	Ca. Maße Approx. Dimensions		Abdichtung Sealing	Bestellzeichen Order-Code	Brutto-Preis Gross-Price Euro (€)
		H	SW			
630	G 1/8"	37	17	Weichdichtung Form C / Soft Sealing Form C	MAS-G 1/8"-wd	48,06
630	G 1/4"	37	19	Weichdichtung Form C / Soft Sealing Form C	MAS-G 1/4"-wd	48,06
630	G 3/8"	40	22	Weichdichtung Form C / Soft Sealing Form C	MAS-G 3/8"-wd	52,85
630	G 1/2"	40	27	Weichdichtung Form C / Soft Sealing Form C	MAS-G 1/2"-wd	75,50

Druck Pressure PN	Gewinde Thread G	Ca. Maße Approx. Dimensions		Abdichtung Sealing	Bestellzeichen Order-Code	Brutto-Preis Gross-Price Euro (€)
		H	SW			
630	R 1/8" keg	36	17	Gewinde Form D / Thread Form D	MAS-R 1/8"-k	57,60
630	R 1/4" keg	36	17	Gewinde Form D / Thread Form D	MAS-R 1/4"-k	57,60

Druck Pressure PN	Gewinde Thread G	Ca. Maße Approx. Dimensions		Abdichtung Sealing	Bestellzeichen Order-Code	Brutto-Preis Gross-Price Euro (€)
		H	SW			
630	1/8" NPT	36	17	Gewinde Form D / Thread Form D	MAS-1/8"-NPT	57,60
630	1/4" NPT	37	17	Gewinde Form D / Thread Form D	MAS-1/4"-NPT	57,60
630	3/8" NPT	40	19	Gewinde Form D / Thread Form D	MAS-3/8"-NPT	68,50
630	1/2" NPT	40	22	Gewinde Form D / Thread Form D	MAS-1/2"-NPT	75,90

Form A

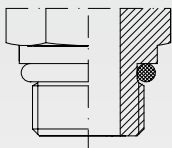

Abdichtung durch Runddichtung (O-Ring) - SAE J 514
Sealing by O-ring in Thread Undercut - SAE J 514

Form C

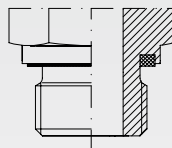

WD = Abdichtung durch gekammerte Profildichtung - Viton
WD = Sealing by an Elastomer Captive Profiled Ring - Viton

Form D

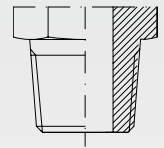

Abdichtung kegelig oder NPT
Sealing by Taper or NPT

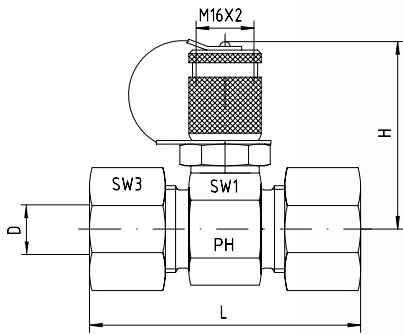

Mit Schraubkupplung M 16 x 2
O-Ring - Viton
Lieferung komplett mit Mutter und Schneidring

With Connection M 16 x 2
O-ring - Viton
Delivery complete with Nut and Cutting Ring

Reihe Series	Druck Pressure PN	Rohr A.D. Tube O.D. D	Ca. Maße Approx. Dimensions				Bestellzeichen Order-Code Standard	Brutto-Preis Gross-Price Euro (€)
			L	H	SW1	SW3		
L	315	6	50,5	49,5	24	14	GMV-L-06	124,75
L	315	8	50,5	49,5	24	17	GMV-L-08	125,25
L	315	10	52,5	49,5	24	19	GMV-L-10	126,25
L	315	12	52,5	49,5	24	22	GMV-L-12	127,75
L	315	15	54,5	52,5	30	27	GMV-L-15	129,25
L	315	18	56,5	53,5	32	32	GMV-L-18	131,25
L	160	22	60,5	55,5	36	36	GMV-L-22	138,75
L	160	28	60,5	58,0	41	41	GMV-L-28	181,50
L	160	35	68,5	60,5	46	50	GMV-L-35	281,20
L	160	42	70,5	65,0	55	60	GMV-L-42	357,50

Reihe Series	Druck Pressure PN	Rohr A.D. Tube O.D. D	Ca. Maße Approx. Dimensions				Bestellzeichen Order-Code Standard	Brutto-Preis Gross-Price Euro (€)
			L	H	SW1	SW3		
S	630	6	54,5	49,5	24	17	GMV-S-06	125,25
S	630	8	54,5	49,5	24	19	GMV-S-08	126,25
S	630	10	56,5	49,5	24	22	GMV-S-10	127,75
S	630	12	56,5	49,5	24	24	GMV-S-12	128,90
S	630	14	62,5	51,0	27	27	GMV-S-14	129,25
S	400	16	62,5	52,5	30	30	GMV-S-16	131,25
S	400	20	68,5	55,5	36	36	GMV-S-20	138,75
S	400	25	74,5	58,0	41	46	GMV-S-25	181,50
S	400	30	80,5	60,5	46	50	GMV-S-30	281,20
S	315	38	91,0	65,0	55	60	GMV-S-38	357,50

GERADE MESSVERSCHRAUBUNGEN STRAIGHT TEST POINT PRESSURE GAUGE FITTINGS

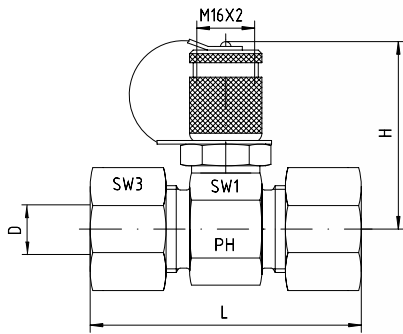

Mit Schraubkupplung M 16 x 2
O-Ring - Viton
Lieferung komplett mit Mutter und Schneidring

With Connection M 16 x 2
O-ring - Viton
Delivery complete with Nut and Cutting Ring

Reihe Series	Druck Pressure PN	Rohr A.D. Tube O.D. D	Ca. Maße Approx. Dimensions				Bestellzeichen Order-Code SC	Brutto-Preis Gross-Price Euro (€)
			L	H	SW1	SW3		
L	315	6	50,5	49,5	24	14	GMV-L-06-SC	125,39
L	315	8	50,5	49,5	24	17	GMV-L-08-SC	126,13
L	315	10	52,5	49,5	24	19	GMV-L-10-SC	127,13
L	315	12	52,5	49,5	24	22	GMV-L-12-SC	128,87
L	315	15	54,5	52,5	30	27	GMV-L-15-SC	131,41
L	315	18	56,5	53,5	32	32	GMV-L-18-SC	134,53
L	160	22	60,5	55,5	36	36	GMV-L-22-SC	142,03
L	160	28	60,5	58,0	41	41	GMV-L-28-SC	185,50
L	160	35	68,5	60,5	46	50	GMV-L-35-SC	288,64
L	160	42	70,5	65,0	55	60	GMV-L-42-SC	366,14

Reihe Series	Druck Pressure PN	Rohr A.D. Tube O.D. D	Ca. Maße Approx. Dimensions				Bestellzeichen Order-Code SC	Brutto-Preis Gross-Price Euro (€)
			L	H	SW1	SW3		
S	630	6	54,5	49,5	24	17	GMV-S-06-SC	126,13
S	630	8	54,5	49,5	24	19	GMV-S-08-SC	127,13
S	630	10	56,5	49,5	24	22	GMV-S-10-SC	128,87
S	630	12	56,5	49,5	24	24	GMV-S-12-SC	130,58
S	630	14	62,5	51,0	27	27	GMV-S-14-SC	132,37
S	400	16	62,5	52,5	30	30	GMV-S-16-SC	134,37
S	400	20	68,5	55,5	36	36	GMV-S-20-SC	134,99
S	400	25	74,5	58,0	41	46	GMV-S-25-SC	187,50
S	400	30	80,5	60,5	46	50	GMV-S-30-SC	289,52
S	315	38	91,0	65,0	55	60	GMV-S-38-SC	368,78



Mit Schraubkupplung M 16 x 2
O-Ring - Viton

With Connection M 16 x 2
O-ring - Viton

Reihe Series	Druck Pressure PN	Rohr A.D. Tube O.D. D	Ca. Maße Approx. Dimensions				Bestellzeichen Order-Code OMD	Brutto-Preis Gross-Price Euro (€)
L	315	6					GMV-L-06-OMD	120,13
L	315	8					GMV-L-08-OMD	119,65
L	315	10					GMV-L-10-OMD	119,53
L	315	12					GMV-L-12-OMD	119,97
L	315	15					GMV-L-15-OMD	118,97
L	315	18					GMV-L-18-OMD	114,01
L	160	22					GMV-L-22-OMD	118,13
L	160	28					GMV-L-28-OMD	151,80
L	160	35					GMV-L-35-OMD	238,98
L	160	42					GMV-L-42-OMD	302,64

Reihe Series	Druck Pressure PN	Rohr A.D. Tube O.D. D	Ca. Maße Approx. Dimensions				Bestellzeichen Order-Code OMD	Brutto-Preis Gross-Price Euro (€)
S	630	6					GMV-S-06-OMD	119,67
S	630	8					GMV-S-08-OMD	119,85
S	630	10					GMV-S-10-OMD	119,87
S	630	12					GMV-S-12-OMD	120,00
S	630	14					GMV-S-14-OMD	118,25
S	400	16					GMV-S-16-OMD	114,83
S	400	20					GMV-S-20-OMD	117,59
S	400	25					GMV-S-25-OMD	144,26
S	400	30					GMV-S-30-OMD	234,32
S	315	38					GMV-S-38-OMD	294,22

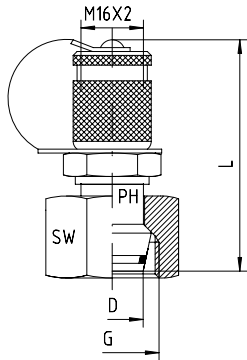

Mit Schraubkupplung M 16 x 2
Anschluss mit Dichtkegel und O-Ring - Viton
Passend in Bohrungsform W DIN 3861
Mit 24°-Konus

*With Connection M 16 x 2
Connection with Taper and O-ring - Viton
For Port End W DIN 3861
With 24°-Cone*

Reihe Series	Druck Pressure PN	Rohr A.D. Tube O.D. D	Gewinde Thread G	Ca. Maße Approx. Dimensions		Bestellzeichen Order-Code	Brutto-Preis Gross-Price Euro (€)
				L	SW		
L	315	6	M 12 x 1,5	72	14	VKA-DKOL-06	102,25
L	315	8	M 14 x 1,5	58	17	VKA-DKOL-08	102,25
L	315	10	M 16 x 1,5	58	19	VKA-DKOL-10	102,25
L	315	12	M 18 x 1,5	54	22	VKA-DKOL-12	79,25
L	315	15	M 22 x 1,5	57	27	VKA-DKOL-15	82,83
L	315	18	M 26 x 1,5	59	32	VKA-DKOL-18	90,50
L	160	22	M 30 x 2	60	36	VKA-DKOL-22	99,70
L	160	28	M 36 x 2	65	41	VKA-DKOL-28	107,40
L	160	35	M 45 x 2	70	50	VKA-DKOL-35	127,82
L	160	42	M 52 x 2	71	60	VKA-DKOL-42	166,15

Reihe Series	Druck Pressure PN	Rohr A.D. Tube O.D. D	Gewinde Thread G	Ca. Maße Approx. Dimensions		Bestellzeichen Order-Code	Brutto-Preis Gross-Price Euro (€)
				L	SW		
S	630	6	M 14 x 1,5	72	17	VKA-DKOS-06	102,25
S	630	8	M 16 x 1,5	58	19	VKA-DKOS-08	102,25
S	630	10	M 18 x 1,5	58	22	VKA-DKOS-10	102,25
S	630	12	M 20 x 1,5	54	24	VKA-DKOS-12	79,50
S	630	14	M 22 x 1,5	70	27	VKA-DKOS-14	82,83
S	400	16	M 24 x 1,5	55	30	VKA-DKOS-16	90,50
S	400	20	M 30 x 2	64	36	VKA-DKOS-20	99,70
S	400	25	M 36 x 2	66	46	VKA-DKOS-25	107,40
S	400	30	M 42 x 2	70	50	VKA-DKOS-30	128,90
S	315	38	M 52 x 2	72	60	VKA-DKOS-38	168,15



Mit Schraubkupplung M 16 x 2

With Metric Swivel End M 16 x 2

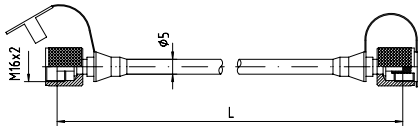

Druck Pressure PN	Schlauch Hose DN	Gewinde Thread	Länge Length L	Bestellzeichen Order-Code	Brutto-Preis Gross-Price Euro (€)
630	02	M 16 x 2	200	SMS-M-16-200	96,60
630	02	M 16 x 2	400	SMS-M-16-400	96,90
630	02	M 16 x 2	630	SMS-M-16-630	97,15
630	02	M 16 x 2	800	SMS-M-16-800	97,40
630	02	M 16 x 2	1000	SMS-M-16-1000	97,65
630	02	M 16 x 2	1500	SMS-M-16-1500	99,15
630	02	M 16 x 2	2000	SMS-M-16-2000	99,65
630	02	M 16 x 2	2500	SMS-M-16-2500	100,15
630	02	M 16 x 2	3200	SMS-M-16-3200	102,15
630	02	M 16 x 2	4000	SMS-M-16-4000	103,95

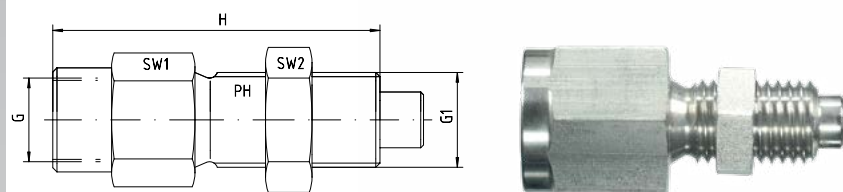

Innengewinde - Starr: BSP + NPT
Außengewinde: M 16 x 2
Dichtung: Viton

Female Thread: BSP + NPT
Male Thread: M 16 x 2
Sealing: Viton

Druck Pressure PN	Gewinde Thread		Ca. Maße Approx. Dimensions			Bestellzeichen Order-Code	Brutto-Preis Gross-Price Euro (€)
	G	G1	H	SW1	SW2		
630	1/4" BSP	M 16 x 2	50	19	19	SMA-20-G 1/4"-V	97,00
630	1/2" BSP	M 16 x 2	60	27	19	SMA-20-G 1/2"-V	126,77

Druck Pressure PN	Gewinde Thread		Ca. Maße Approx. Dimensions			Bestellzeichen Order-Code	Brutto-Preis Gross-Price Euro (€)
	G	G1	H	SW1	SW2		
630	1/4" NPT	M 16 x 2	50	19	19	SMA-20-1/4"-NPT-V	139,00
630	1/2" NPT	M 16 x 2	60	27	19	SMA-20-1/2"-NPT-V	196,00

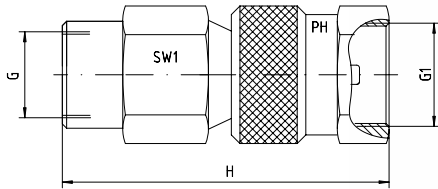

Innengewinde - Starr: BSP + NPT
Muttergewinde - Drehbar: M 16 x 2
Dichtung: Viton

Female Thread: BSP + NPT
Nut Female Swivel: M 16 x 2
Sealing: Viton

Druck Pressure PN	Gewinde Thread		Ca. Maße Approx. Dimensions		Bestellzeichen Order-Code	Brutto-Preis Gross-Price Euro (€)
	G	G1	H	SW1		
630	1/4" BSP	M 16 x 2	41	19	SMD-20-G 1/4"	96,43
630	1/2" BSP	M 16 x 2	51	27	SMD-20-G 1/2"	156,00

Druck Pressure PN	Gewinde Thread		Ca. Maße Approx. Dimensions		Bestellzeichen Order-Code	Brutto-Preis Gross-Price Euro (€)
	G	G1	H	SW1		
630	1/4" NPT	M 16 x 2	41	19	SMD-20-1/4"-NPT	119,00
630	1/2" NPT	M 16 x 2	51	27	SMD-20-1/2"-NPT	*





Steckkupplungen und Schraubkupplungen Push and Pull Couplings and Screw Couplings









15



STECKKUPPLUNGEN UND SCHRAUBKUPPLUNGEN

PUSH AND PULL COUPLINGS AND SCREW COUPLINGS

Produktgruppen	Product Groups	Seite Page
 Steckkupplungen - ISO-Norm B - Technische Daten / Druckverlust - Rohringengewinde - ISO 228 - NPT-Innengewinde	Quick Release Couplings - ISO-Norm B - Technical Data / Pressure Drop - BSP - Parallel - ISO 228 - NPT - Female	15.2
		15.3
		15.4
 Schnellverschluss-Schraubkupplungen - Technische Daten - Technische Daten / Druckverlust - Typ: SK - BSP - Zylindrisch - Typ: SK - Für lötlöse Rohrverschraubungen - Typ: SK - Für lötlöse Rohrverschraubungen	Quick Disconnect Screw Couplings - Technical Data - Technical Data / Pressure Drop - Type: SK - BSP - Parallel - Type: SK - For Solderless Connectors - Type: SK - For Solderless Connectors	15.5
		15.6
		15.7
		15.8
		15.9
 Zubehör zu Schnellverschluss-Schraubkupplungen - Verschlusskappe - Typ: SK - Verschlussstopfen - Typ: SK - Verschlusskappe - Typ: ISO-Norm B - Verschlussstopfen Typ: ISO-Norm B	Accessories for Quick Disconnect Screw Couplings - Dust Cap - Type: SK - Dust Plug - Type: SK - Dust Cap - Type: ISO-Norm B - Dust Plug - Type: ISO-Norm B	15.10
		15.11
		15.12
		15.13
 Flat -Face Steckkupplungen - Technische Daten / Druckverlust - Technische Daten / Druckverlust - Typ: FF - BSP - Zylindrisch	Flat-Face Quick Release Couplings - Technical Data / Pressure Drop - Technical Data / Pressure Drop - Type: FF - BSP - Parallel	15.14
		15.15
		15.16
 Hochdruck-Schraubkupplungen - Technische Daten / Druckverlust - Technische Daten / Druckverlust - Technische Daten / Druckverlust - Typ: HSK - BSP - Zylindrisch	High Pressure Screw Couplings - Technical Data / Pressure Drop - Technical Data / Pressure Drop - Technical Data / Pressure Drop - Type: HSK - BSP - Parallel	15.17
		15.18
		15.19
		15.20
 Zubehör zu Hochdruck-Schraubkupplungen - Verschlussstopfen - Verschlusskappe	Accessories for High Pressure Screw Couplings - Dust Plug - Dust Cap	15.21
		15.22
Anwendung und Instandhaltung	Use and Maintenance	15.23
Anwendung und Instandhaltung	Use and Maintenance	15.24
Wichtige Fragen und Empfehlungen	Important issues and suggestions	15.25

TECHNISCHE DATEN / DRUCKVERLUST -
 STECKKUPPLUNGEN - ISO-NORM B
 TECHNICAL DATA / PRESSURE DROP - QUICK RELEASE
 COUPLINGS - ISO-NORM B

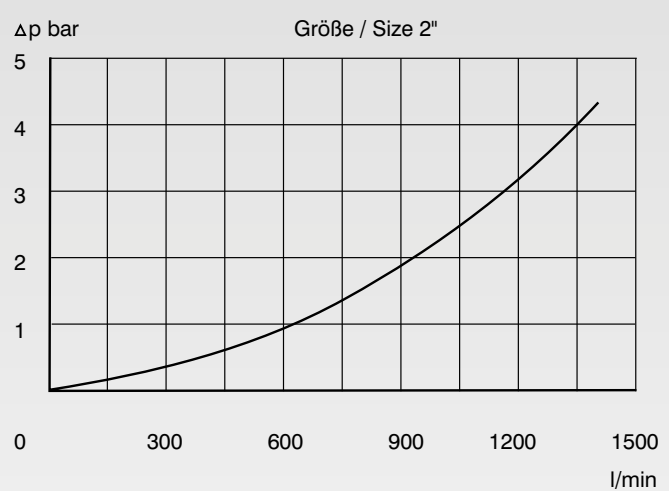
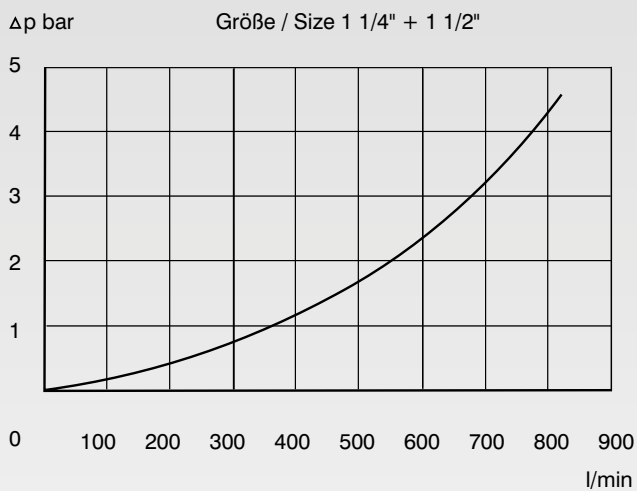
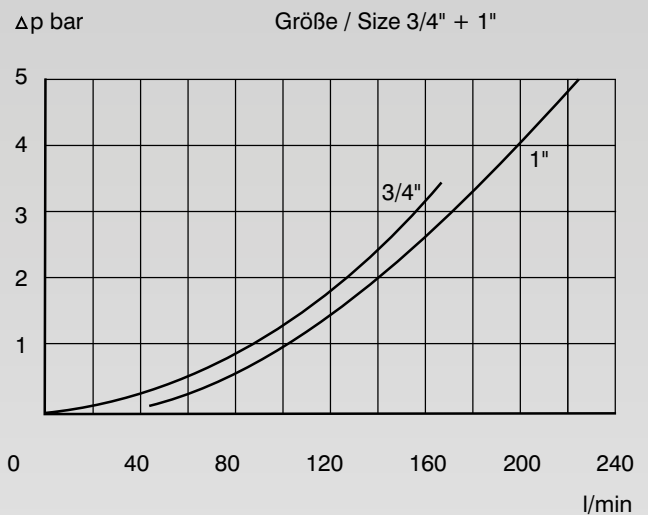

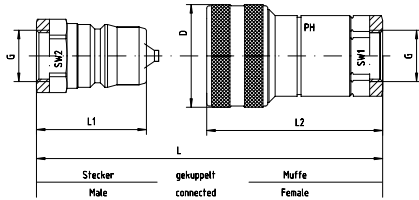

ISO-Norm B

Komplett hergestellt aus Edelstahl mit Viton-Dichtungen und PTFE Stützringen

Rohrinnengewinde DIN / ISO 228

Diese Kupplungen sind austauschbar mit ISO-Standard "B-Serie", außerdem austauschbar mit Kugelserie.

Platzdruck: 2,5 fache Sicherheit gegen Arbeitsdruck

ISO-Norm B

Completely made in AISI 316 Stainless Steel, Viton Seals and PTFE „bk“ Rings

BSPP - Female Thread DIN / ISO 228

They are interchangeable with ISO-Standard "B-Series", also available with ball occlusion.

Burst Pressure: 2,5 times Working Pressure

Druck Pressure PB	Gewinde Thread G = BSP	Ca. Maße Approx. Dimensions						Durchflussmenge Flow Rate l/min.	Bestellzeichen Order-Code Muffe / Female	Brutto-Preis Gross-Price Euro (€)
		D	L	L1	L2	SW1	SW2			
300	1/8"	24	62,0		50,0	14		6	SV-Mu-G 1/8"	54,65
300	1/4"	28	74,5		58,5	19		12	SV-Mu-G 1/4"	50,25
250	3/8"	35	78,5		64,0	24		23	SV-Mu-G 3/8"	56,20
250	1/2"	42	91,5		73,0	30		45	SV-Mu-G 1/2"	68,00
250	3/4"	52	107,5		87,5	36		105	SV-Mu-G 3/4"	92,75
200	1"	60	126,5		103,0	41		185	SV-Mu-G 1"	144,15
140	1 1/4"	75	198,0		126,0	65		370	SV-Mu-G 1 1/4"	312,00
140	1 1/2"	75	199,0		126,0	65		370	SV-Mu-G 1 1/2"	312,00
90	2"	105	222,0		142,0	90		750	SV-Mu-G 2"	765,00

Druck Pressure PB	Gewinde Thread G = BSP	Ca. Maße Approx. Dimensions						Durchflußmenge Flow Rate l/min.	Bestellzeichen Order-Code Stecker / Male	Brutto-Preis Gross-Price Euro (€)
		D	L	L1	L2	SW1	SW2			
300	1/8"		62,0	31,0			14	6	SV-St-G 1/8"	24,00
300	1/4"		74,5	37,0			19	12	SV-St-G 1/4"	21,80
250	3/8"		78,5	39,0			22	23	SV-St-G 3/8"	23,80
250	1/2"		91,5	45,5			27	45	SV-St-G 1/2"	26,20
250	3/4"		107,5	54,0			36	105	SV-St-G 3/4"	43,10
200	1"		126,5	63,0			41	185	SV-St-G 1"	60,30
140	1 1/4"		198,0	126,0			65	370	SV-St-G 1 1/4"	253,50
140	1 1/2"		199,0	126,0			65	370	SV-St-G 1 1/2"	253,50
90	2"		222,0	142,0			90	750	SV-St-G 2"	552,00

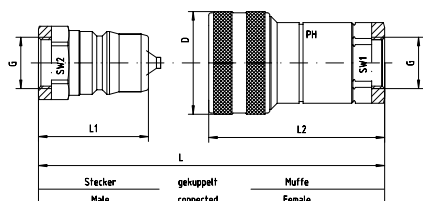

ISO-Norm B

Komplett hergestellt aus Edelstahl mit Viton-Dichtungen und PTFE Stützringen
NPT-Innengewinde
Diese Kupplungen sind austauschbar mit ISO-Standard "B-Serie", außerdem austauschbar mit Kugelserie.
Platzdruck: 2,5 fache Sicherheit gegen Arbeitsdruck

ISO-Norm B

Completely made in AISI 316 Stainless Steel, Viton Seals and PTFE „bk“ Rings
NPT - Female Thread
They are interchangeable with ISO-Standard "B-Series", also available with ball occlusion.
Burst Pressure: 2,5 times Working Pressure

Druck Pressure PB	Gewinde Thread G = NPT	Ca. Maße Approx. Dimensions						Durchflußmenge Flow Rate l/min.	Bestellzeichen Order-Code Muffe / Female	Brutto-Preis Gross-Price Euro (€)
		D	L	L1	L2	SW1	SW2			
300	1/8"	24	62,0		50,0	14		6	SV-Mu-NPT-1/8"	60,70
300	1/4"	28	74,5		58,5	19		12	SV-Mu-NPT-1/4"	54,10
250	3/8"	35	78,5		64,0	24		23	SV-Mu-NPT-3/8"	60,50
250	1/2"	42	91,5		73,0	30		45	SV-Mu-NPT-1/2"	73,22
250	3/4"	52	107,5		87,5	36		105	SV-Mu-NPT-3/4"	111,00
200	1"	60	126,5		103,0	41		185	SV-Mu-NPT-1"	172,45
140	1 1/4"	75	198,0		126,0	65		370	SV-Mu-NPT-1 1/4"	374,00
140	1 1/2"	75	199,0		126,0	65		370	SV-Mu-NPT-1 1/2"	374,00
90	2"	105	222,0		142,0	90		750	SV-Mu-NPT-2"	915,10

Druck Pressure PB	Gewinde Thread G = NPT	Ca. Maße Approx. Dimensions						Durchflußmenge Flow Rate l/min.	Bestellzeichen Order-Code Stecker / Male	Brutto-Preis Gross-Price Euro (€)
		D	L	L1	L2	SW1	SW2			
300	1/8"		62,0	31,0			14	6	SV-St-NPT-1/8"	26,80
300	1/4"		74,5	37,0			19	12	SV-St-NPT-1/4"	23,45
250	3/8"		78,5	39,0			22	23	SV-St-NPT-3/8"	25,65
250	1/2"		91,5	45,5			27	45	SV-St-NPT-1/2"	28,25
250	3/4"		107,5	54,0			36	105	SV-St-NPT-3/4"	51,45
200	1"		126,5	63,0			41	185	SV-St-NPT-1"	72,15
140	1 1/4"		198,0	126,0			65	370	SV-St-NPT-1 1/4"	302,60
140	1 1/2"		199,0	126,0			65	370	SV-St-NPT-1 1/2"	302,60
90	2"		222,0	142,0			90	750	SV-St-NPT-2"	660,55



Schnellverschluss-Schraubkupplungen sperren beidseitig ab. Die Verbindung von Kupplungsmuffe und Kupplungsstecker erfolgt durch Verschraubung mit der Handmutter. Beim Kupplungsvorgang ist der Ventilraum bereits abgedichtet bevor die Ventile sich öffnen. Beim Entkuppeln noch geschlossen bevor die Verbindung getrennt werden kann. Das Kuppeln unter Druck stehender Kupplungshälften ist zu vermeiden, da sonst die Ventileinheiten beschädigt werden.

- Sicher gegen Druckstöße und Druckschwingungen
- Strömungsgünstige Ausbildung des Durchflussbereiches

Technische Daten (Standardausführung)

Werkstoff: V4a = AISI 316, Dichtungen aus FPM (Viton), Stützring aus PTFE
Verwendbarkeit: Hydraulikflüssigkeiten auf Mineralöl- und Glycolbasis, Luft und Wasser mit Korrosionsschutz
Temperaturbereich: -20°C bis +200°C

Quick Release Screw Couplings shut off on both parts. The connection of male and female part arises in screwing the hand nut. During the coupling process the outlet is tight before the opening of the valve. By dismantling the coupling the valves are closed before the disconnection of both parts. To safe the function of the valve parts the connection process under pressure should be avoided.

- Secure against pressure impulses
- Current favorable formation of the flow range

Technical Data (Standard Version)

Material: V4a = AISI 316, Sealings from FPM (Viton), Back-up Ring from PTFE

Utilization: Hydraulic fluids on mineral oil and glycol base, air and water with corrosion protection

Temperature Range: -20°C to +200°C

DN	Durchflussquerschnitt Flow Cross Section mm ²	Nenndruck / Pressure				Baugröße Size
		Kupplung gekuppelt Coupling connected bar	Kupplung getrennt / Coupling separate		Kupplungs-Stecker Coupling - Male bar	
			Kupplungs-Muffe Coupling - Female bar			
5-6	25	450	450	450	1	
6-8	50	400	400	400	2	
8-12	75	400	400	400	3	
10-16	150	250	250	250	4	
16-25	208	250	250	250	6	
25-32	525	200	200	200	8	

Platzdruck: 2,5 fache Sicherheit gegen Arbeitsdruck
Burst Pressure: 2,5 times Working Pressure

TECHNISCHE DATEN / DRUCKVERLUST SCHNELLVERSCHLUSS- SCHRAUBKUPPLUNGEN

TECHNICAL DATA / PRESSURE DROP -
QUICK DISCONNECT SCREW COUPLINGS

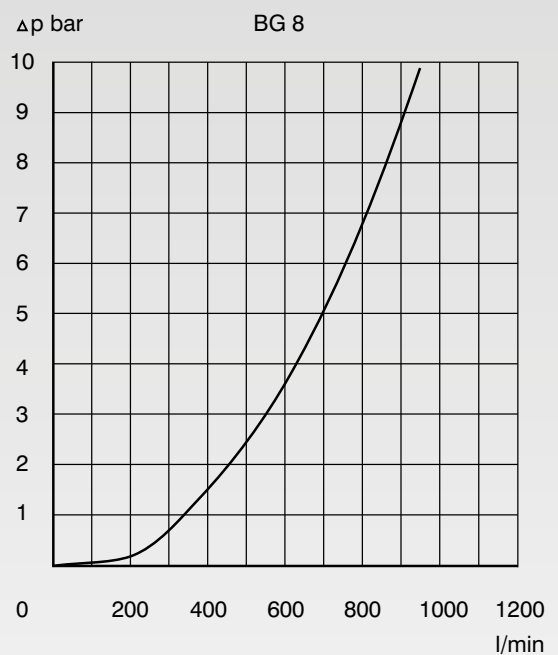
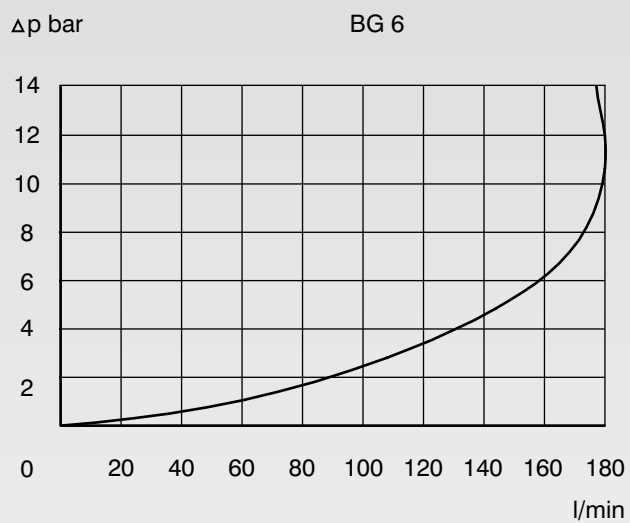
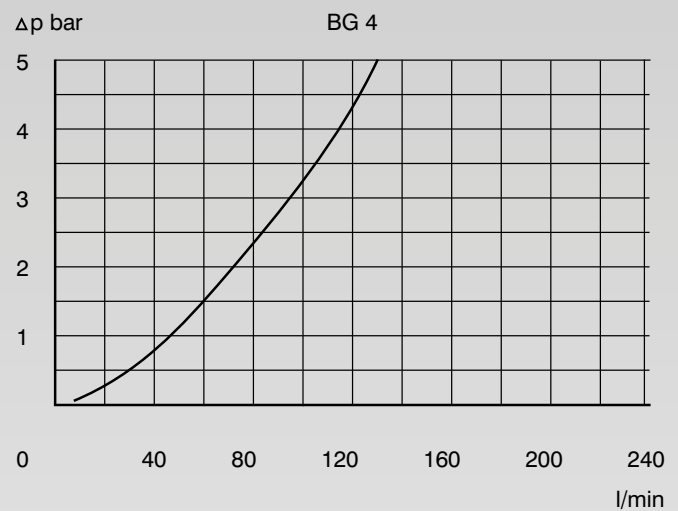
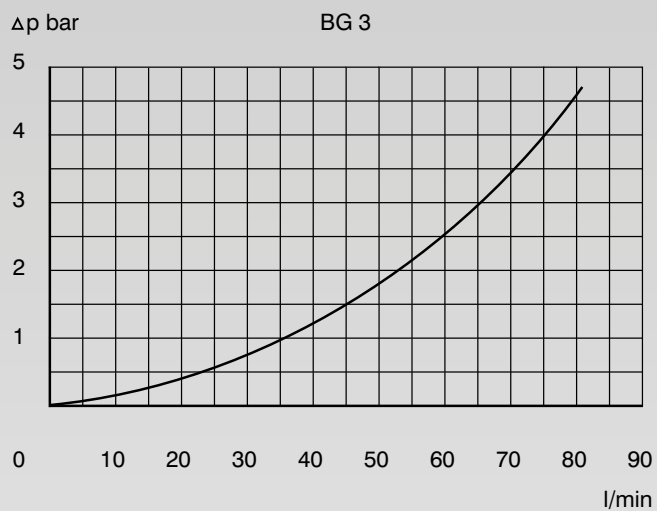
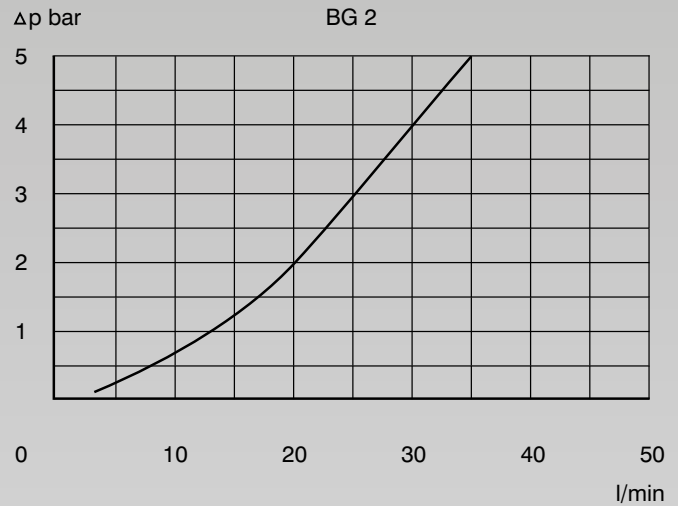
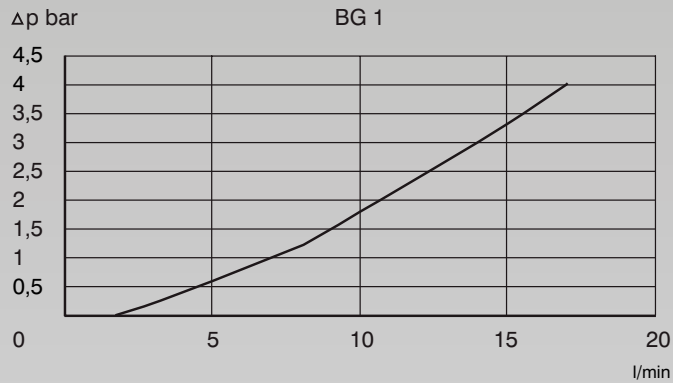

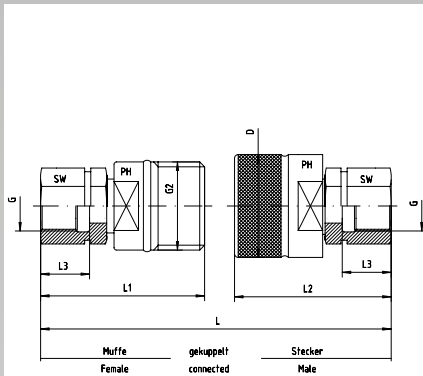

Anschluss-Innengewinde: BSP - Zylindrisch
DIN / ISO 228

Female Thread: BSP - Parallel
DIN / ISO 228

Baugröße Size	DN	Gewinde Thread		Ca. Maße Approx. Dimensions						Bestellzeichen Order-Code Muffe / Female	Brutto-Preis Gross-Price Euro (€)
		G = BSP	G2	D	L	L1	L2	L3	SW		
1	6	G 1/4"	24 x 2		92,0	59,0		13	19	SKM-1-G 1/4"	48,85
2	8	G 3/8"	28 x 2		98,5	64,0		13	22	SKM-2-G 3/8"	48,85
3	12	G 1/2"	36 x 2		103,0	67,0		15	30	SKM-3-G 1/2"	58,00
4	16	G 3/4"	42 x 2		123,5	81,5		18	36	SKM-4-G 3/4"	94,90
6	20	G 1"	48 x 3		144,5	97,0		22	41	SKM-6-G 1"	124,15
8	32	G 1 1/2"	70 x 3		187,0	116,0		25	60	SKM-8-G 1 1/2"	490,00

Baugröße Size	DN	Gewinde Thread		Ca. Maße Approx. Dimensions						Bestellzeichen Order-Code Stecker / Male	Brutto-Preis Gross-Price Euro (€)
		G = BSP	G2	D	L	L1	L2	L3	SW		
1	6	G 1/4"	24 x 2	30	92,0		58,0	13	19	SKS-1-G 1/4"	67,30
2	8	G 3/8"	28 x 2	35	98,5		61,0	13	22	SKS-2-G 3/8"	67,30
3	12	G 1/2"	36 x 2	42	103,0		63,5	15	30	SKS-3-G 1/2"	73,00
4	16	G 3/4"	42 x 2	48	123,5		73,5	18	36	SKS-4-G 3/4"	129,35
6	20	G 1"	48 x 3	55	144,5		82,5	22	41	SKS-6-G 1"	168,35
8	32	G 1 1/2"	70 x 3	80	187,0		107,0	25	60	SKS-8-G 1 1/2"	490,00

SCHNELLVERSCHLUSS- SCHRAUBKUPPLUNGEN - TYP: SK

QUICK DISCONNECT SCREW COUPLINGS - TYPE: SK



EDELSTAHL / STAINLESS STEEL
VERBINDUNGSTECHNIK
FLUID CONNECTORS

Anschluss für lötlöse Rohrverschraubungen
DIN 2353 / DIN EN ISO 8434-1

Fittings for Solderless Connectors
DIN 2353 / DIN EN ISO 8434-1

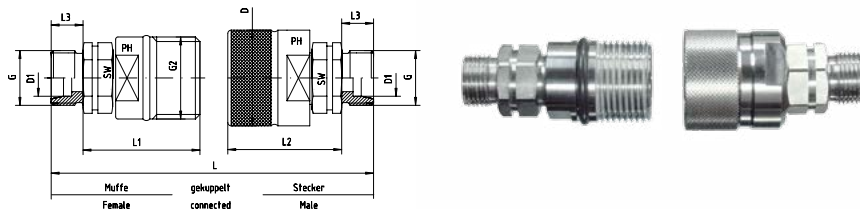

Reihe Series	Baugröße Size	DN	Gewinde Thread		Ca. Maße Approx. Dimensions						Bestellzeichen Order-Code	Brutto-Preis Gross-Price		
			G	G2	D	D1	L	L1	L2	L3			SW	Muffe / Female
L	1	5	M 12 x 1,5	24 x 2		6					10	19	SKM-1-06-L	*
L	2	6	M 14 x 1,5	28 x 2		8	102	56,0		10	22	SKM-2-08-L	*	
L	2	8	M 16 x 1,5	28 x 2		10	104	56,0		11	22	SKM-2-10-L	*	
L	3	10	M 18 x 1,5	36 x 2		12	99	54,5		11	30	SKM-3-12-L	63,80	
L	3	12	M 22 x 1,5	36 x 2		15	101	54,5		12	30	SKM-3-15-L	63,80	
L	4	16	M 26 x 1,5	42 x 2		18				12	36	SKM-4-18-L	*	
L	6	20	M 30 x 2	48 x 3		22	137	79,5		14	41	SKM-6-22-L	*	
L	6	25	M 36 x 2	48 x 3		28				14	41	SKM-6-28-L	*	
L	8	32	M 45 x 2	70 x 3		35				16	55	SKM-8-35-L	*	
L	8	40	M 52 x 2	70 x 3		42				16	55	SKM-8-42-L	*	

Reihe Series	Baugröße Size	DN	Gewinde Thread		Ca. Maße Approx. Dimensions						Bestellzeichen Order-Code	Brutto-Preis Gross-Price	
			G	G2	D	D1	L	L1	L2	L3			SW
L	1	5	M 12 x 1,5	24 x 2	30	6				10	19	SKS-1-06-L	*
L	2	6	M 14 x 1,5	28 x 2	35	8	102		53	10	22	SKS-2-08-L	*
L	2	8	M 16 x 1,5	28 x 2	35	10	104		53	11	22	SKS-2-10-L	*
L	3	10	M 18 x 1,5	36 x 2	42	12	99		51	11	30	SKS-3-12-L	80,30
L	3	12	M 22 x 1,5	36 x 2	42	15	101		51	12	30	SKS-3-15-L	80,30
L	4	16	M 26 x 1,5	42 x 2	48	18				12	36	SKS-4-18-L	*
L	6	20	M 30 x 2	48 x 3	55	22	137		65	14	41	SKS-6-22-L	*
L	6	25	M 36 x 2	48 x 3	55	28				14	41	SKS-6-28-L	*
L	8	32	M 45 x 2	70 x 3	80	35				16	55	SKS-8-35-L	*
L	8	40	M 52 x 2	70 x 3	80	42				16	55	SKS-8-42-L	*



Anschluss für lötlöse Rohrverschraubungen
DIN 2353 / DIN EN ISO 8434-1

Fittings for Solderless Connectors
DIN 2353 / DIN EN ISO 8434-1

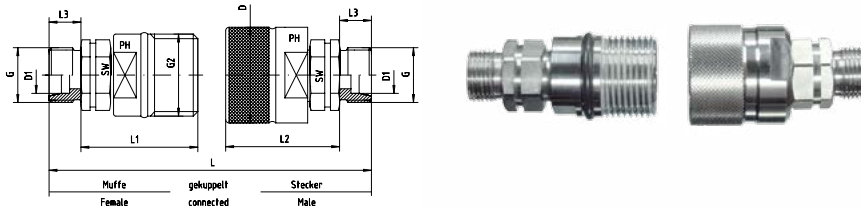

Reihe Series	Baugröße Size	DN	Gewinde Thread		Ca. Maße Approx. Dimensions						Bestellzeichen Order-Code	Brutto-Preis Gross-Price		
			G	G2	D	D1	L	L1	L2	L3			SW	Muffe / Female
S	1	5	M 16 x 1,5	24 x 2		8					12	19	SKM-1-08-S	*
S	2	6	M 18 x 1,5	28 x 2		10	100	53,0			12	27	SKM-2-10-S	*
S	2	8	M 20 x 1,5	28 x 2		12	100	53,0			12	27	SKM-2-12-S	*
S	3	10	M 22 x 1,5	36 x 2		14					14	30	SKM-3-14-S	*
S	3	12	M 24 x 1,5	36 x 2		16	105	54,5			14	30	SKM-3-16-S	63,80
S	4	16	M 30 x 2	42 x 2		20	125	66,5			16	36	SKM-4-20-S	*
S	6	20	M 36 x 2	48 x 3		25	145	79,5			18	41	SKM-6-25-S	136,60
S	8	25	M 42 x 2	70 x 3		30					20	55	SKM-8-30-S	*
S	8	32	M 52 x 2	70 x 3		38					22	55	SKM-8-38-S	*

Reihe Series	Baugröße Size	DN	Gewinde Thread		Ca. Maße Approx. Dimensions						Bestellzeichen Order-Code	Brutto-Preis Gross-Price		
			G	G2	D	D1	L	L1	L2	L3			SW	Stecker / Male
S	1	5	M 16 x 1,5	24 x 2	30	8					12	19	SKS-1-08-S	*
S	2	6	M 18 x 1,5	28 x 2	35	10	100		50,0		12	27	SKS-2-10-S	*
S	2	8	M 20 x 1,5	28 x 2	35	12	100		50,0		12	27	SKS-2-12-S	*
S	3	10	M 22 x 1,5	36 x 2	42	14					14	30	SKS-3-14-S	*
S	3	12	M 24 x 1,5	36 x 2	42	16	105		51,0		14	30	SKS-3-16-S	80,30
S	4	16	M 30 x 2	42 x 2	48	20	125		58,5		16	36	SKS-4-20-S	*
S	6	20	M 36 x 2	48 x 3	55	25	145		65,0		18	41	SKS-6-25-S	185,20
S	8	25	M 42 x 2	70 x 3	80	30					20	55	SKS-8-30-S	*
S	8	32	M 52 x 2	70 x 3	80	38					22	55	SKS-8-38-S	*

ZUBEHÖR ZU SCHNELLVERSCHLUSS- KUPPLUNGEN TYP: SK

ACCESSORIES FOR QUICK DISCONNECT COUPLINGS
TYPE: SK



EDELSTAHL / STAINLESS STEEL
VERBINDUNGSTECHNIK
FLUID CONNECTORS



**Staubschutz für Schnellverschluss-Schraub-
kupplungen**

Verschlusskappe - Kunststoff - für Muffe

Dust Protection for Quick Screw Couplings

Dust Cap - Plastic - for Female

Baugröße Size	G		Bestellzeichen Order-Code	Brutto-Preis Gross-Price Euro (€)
1	24 x 2		SS-SKM-1	3,70
2	28 x 2		SS-SKM-2	3,00
3	36 x 2		SS-SKM-3	3,50
4	42 x 2		SS-SKM-4	4,20
6	48 x 3		SS-SKM-6	3,70
8	70 x 3		SS-SKM-8	6,90



ZUBEHÖR ZU SCHNELLVERSCHLUSS- KUPPLUNGEN TYP: SK

ACCESSORIES FOR QUICK DISCONNECT COUPLINGS
TYPE: SK



**Staubschutz für Schnellverschluss-Schraub-
kupplungen**

Verschlussstopfen - Kunststoff - für Stecker

Dust Protection for Quick Screw Couplings

Dust Plug - Plastic - for Male

Baugröße Size	G		Bestellzeichen Order-Code	Brutto-Preis Gross-Price Euro (€)
1	24 x 2		SS-SKS-1	3,70
2	28 x 2		SS-SKS-2	2,50
3	36 x 2		SS-SKS-3	2,70
4	42 x 2		SS-SKS-4	4,20
6	48 x 3		SS-SKS-6	3,10
8	70 x 3		SS-SKS-8	4,75

ZUBEHÖR ZU SCHNELLVERSCHLUSS- KUPPLUNGEN

ACCESSORIES FOR QUICK DISCONNECT COUPLINGS



EDELSTAHL / STAINLESS STEEL
VERBINDUNGSTECHNIK
FLUID CONNECTORS



Staubschutz für Schnellverschluss-Steckkupplungen
ISO-Norm B
Verschlusskappe - Kunststoff - für Stecker

*Dust Protection for Quick Release Couplings
ISO-Norm B
Dust Cap - Plastic - for Male*

Baugröße Size	Bestellzeichen Order-Code	Brutto-Preis Gross-Price Euro (€)
1/8"	SS-St-1/8"	3,30
1/4"	SS-St-1/4"	3,30
3/8"	SS-St-3/8"	3,30
1/2"	SS-St-1/2"	3,40
3/4"	SS-St-3/4"	8,25
1"	SS-St-1"	11,25
1 1/4"	SS-St-1 1/4"	29,80
1 1/2"	SS-St-1 1/2"	29,80
2"	SS-St-2"	50,80



Staubschutz für Schnellverschluss-Steckkupplungen
ISO-Norm B
Verschlussstopfen - Kunststoff - für Muffe

*Dust Protection for Quick Release Couplings
ISO-Norm B
Dust Plug - Plastic - for Female*

Baugröße Size	Bestellzeichen Order-Code	Brutto-Preis Gross-Price Euro (€)
1/8"	SS-Mu-1/8"	3,30
1/4"	SS-Mu-1/4"	3,30
3/8"	SS-Mu-3/8"	3,30
1/2"	SS-Mu-1/2"	3,40
3/4"	SS-Mu-3/4"	8,25
1"	SS-Mu-1"	11,25
1 1/4"	SS-Mu-1 1/4"	19,50
1 1/2"	SS-Mu-1 1/2"	19,50
2"	SS-Mu-2"	45,00

TECHNISCHE DATEN / DRUCKVERLUST FLAT-FACE STECKKUPPLUNGEN

TECHNICAL DATA / PRESSURE DROP - FLAT-FACE
QUICK RELEASE COUPLINGS



EDELSTAHL / STAINLESS STEEL
VERBINDUNGSTECHNIK
FLUID CONNECTORS

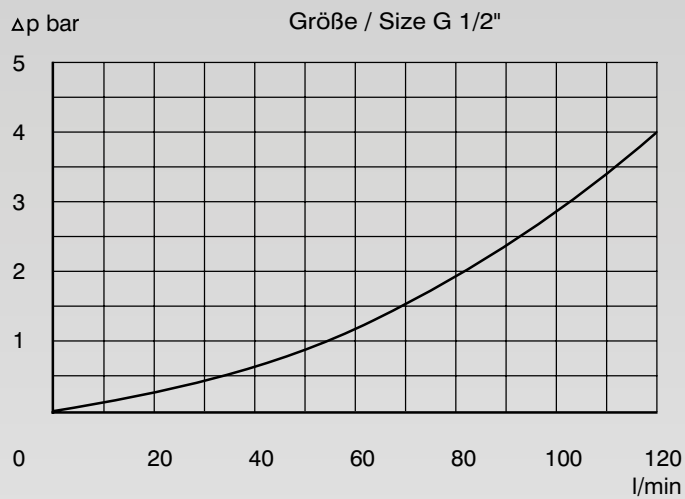
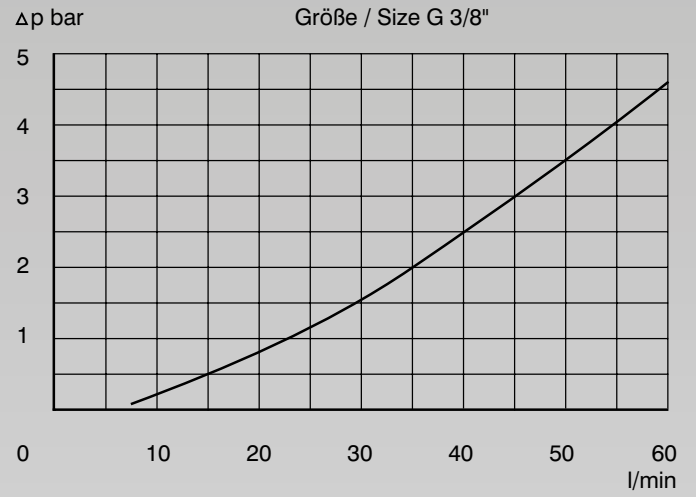

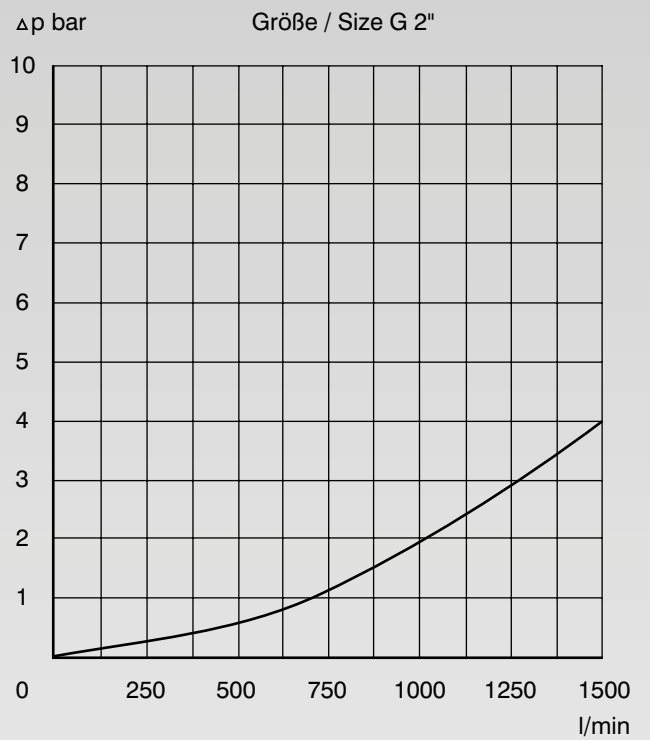
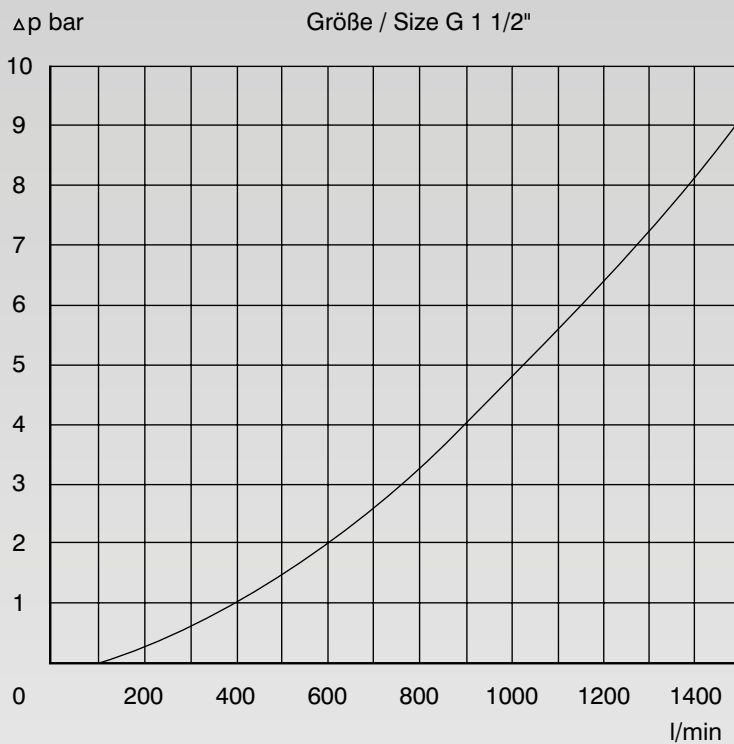
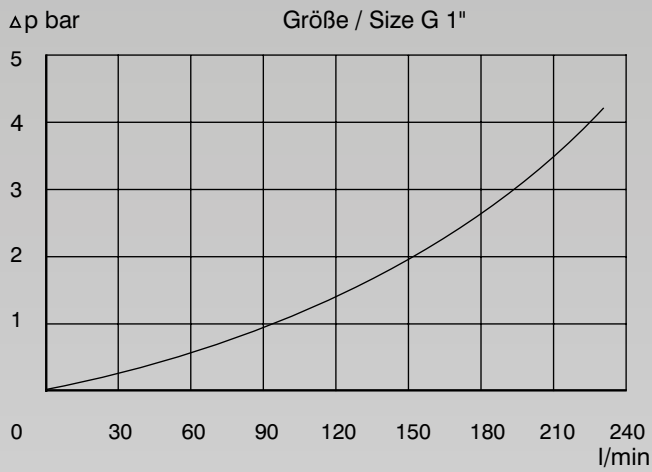

FLAT-FACE STECKKUPPLUNGEN

FLAT-FACE QUICK RELEASE COUPLINGS

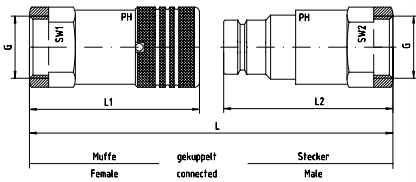

Nach ISO-Norm 16028 Standard
Mit Rohringengewinde: BSP - Zylindrisch
DIN / ISO 228

According to ISO-Norm 16028 Standard
Female Thread: BSP - Parallel
DIN / ISO 228

Druck Pressure PN	Gewinde Thread G	Ca. Maße Approx. Dimensions					Durchflussmenge Flow Rate l/min.	Bestellzeichen Order-Code Muffe / Female	Brutto-Preis Gross-Price Euro (€)
		L	L1	L2	SW1	SW2			
315	1/4"-19	86,0	48,0		22		12	FF-1/4"-F	140,00
250	3/8"-19	118,0	68,0		27		23	FF-3/8"-F	151,20
250	1/2"-14	125,0	74,0		32		45	FF-1/2"-F	188,15
250	3/4"-14	130,0	79,0		36		74	FF-3/4"-F	227,50
250	1"-11	153,0	93,0		45		100	FF-1"-F	239,50
200	1 1/4"-11	172,5	106,0		55		189	FF-1 1/4"-F	345,70
90	1 1/2"-11	173,0	132,5		65		288	FF-1 1/2"-F	572,00
60	2"-11	242,0	157,0		75		379	FF-2"-F	1738,00

Druck Pressure PN	Gewinde Thread G	Ca. Maße Approx. Dimensions					Durchflussmenge Flow Rate l/min.	Bestellzeichen Order-Code Stecker / Male	Brutto-Preis Gross-Price Euro (€)
		L	L1	L2	SW1	SW2			
315	1/4"-19	86,0		48		22	12	FF-1/4"-M	89,25
250	3/8"-19	118,0		67		27	23	FF-3/8"-M	106,40
250	1/2"-14	125,0		68		32	45	FF-1/2"-M	123,50
250	3/4"-14	130,0		70		36	74	FF-3/4"-M	154,00
250	1"-11	153,0		82		45	100	FF-1"-M	168,50
200	1 1/4"-11	172,5		90		55	189	FF-1 1/4"-M	240,70
90	1 1/2"-11	173,0		112		65	288	FF-1 1/2"-M	399,00
60	2"-11	242,0		124		75	379	FF-2"-M	1114,00

Flat-Face Kupplungen sind beidseitig absperrende Steckkupplungen mit Kugelverriegelung.

Die Verschmutzung der Kupplungshälften an den Kuppelstellen ist durch die flache Konstruktion sehr gering. Die Kupplung kann im drucklosen Zustand durch Einhandbedienung gekuppelt und entkuppelt werden. Der Flüssigkeitsverlust ist minimal. Es entsteht kein Luftabschluss beim Kupplungsvorgang, die Standard-Dichtungskombination ist Viton/PTFE.

Die Arbeitstemperatur ist von -20°C bis +200°C.

Flat-face quick couplings are supplied with a ball-lock-system.

Because of its flat construction, dirt particles can only arise at a minimum at the coupling surface. The couplings could be connected and disconnected after full release of pressure in the system. Loss of liquid is at a minimum level, coupling procedure can be arranged with one-hand only. Air control arise during the coupling process. The standard sealing combination is Viton/PTFE.

Working temperature is from -20°C to 200°C.

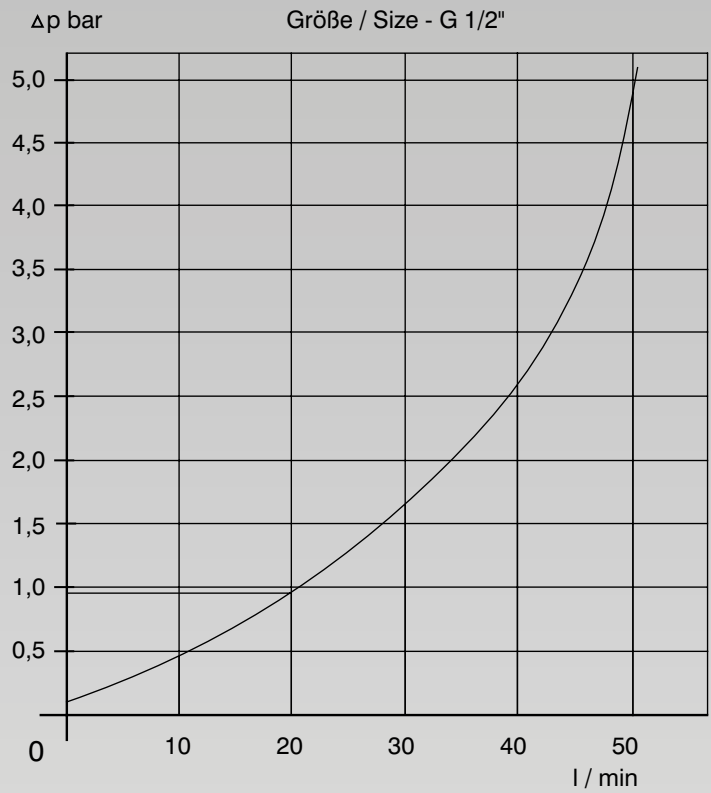
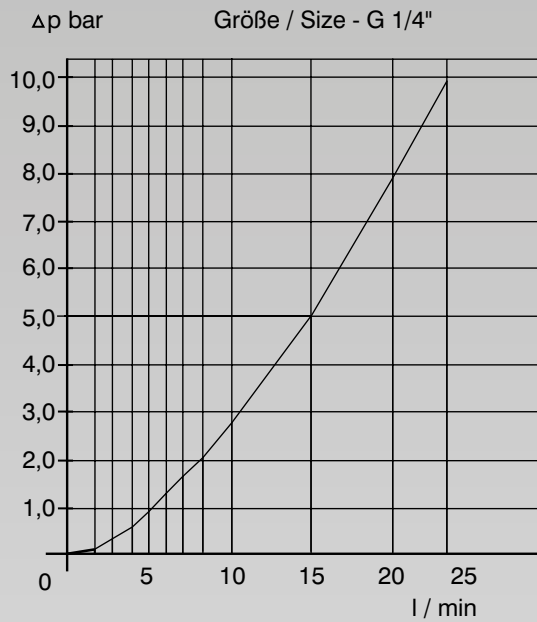

TECHNISCHE DATEN / DRUCKVERLUST
HOCHDRUCK-SCHRAUBKUPPLUNGEN
TECHNICAL DATA / PRESSURE DROP -
HIGH PRESSURE SCREW COUPLINGS



EDELSTAHL / STAINLESS STEEL
VERBINDUNGSTECHNIK
FLUID CONNECTORS

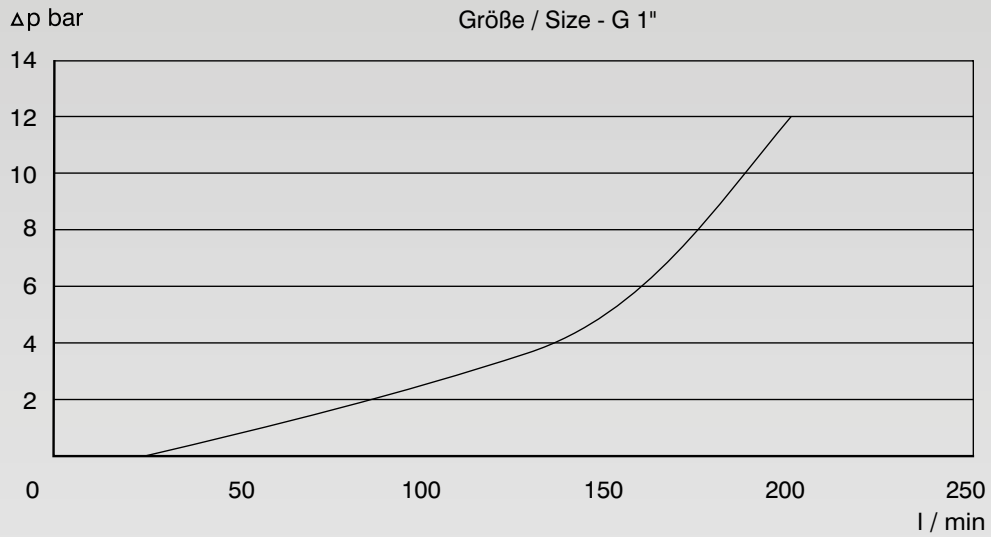
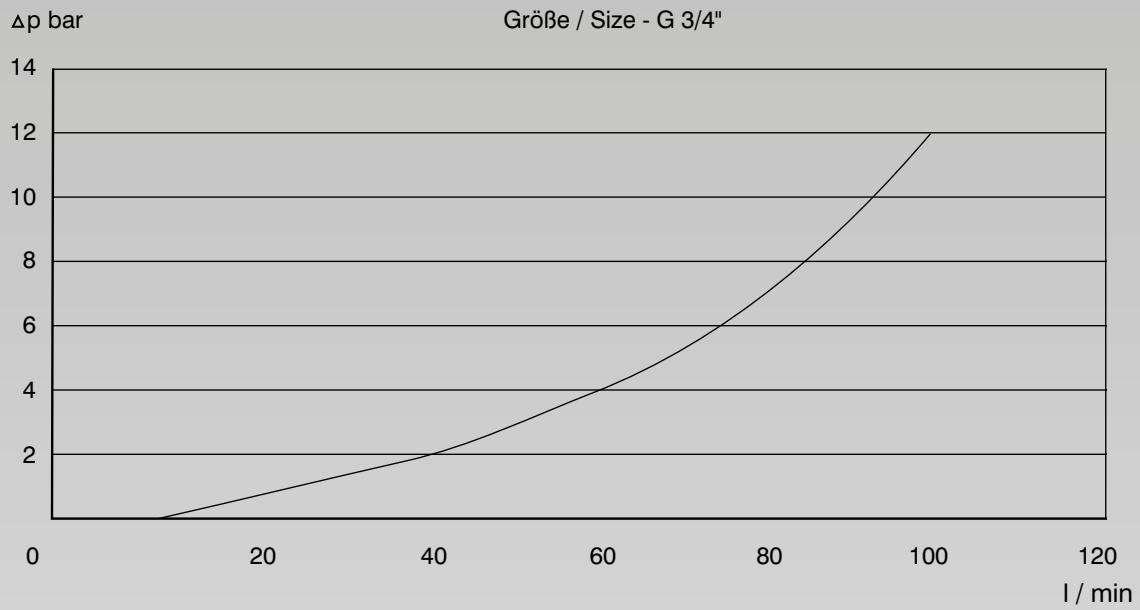

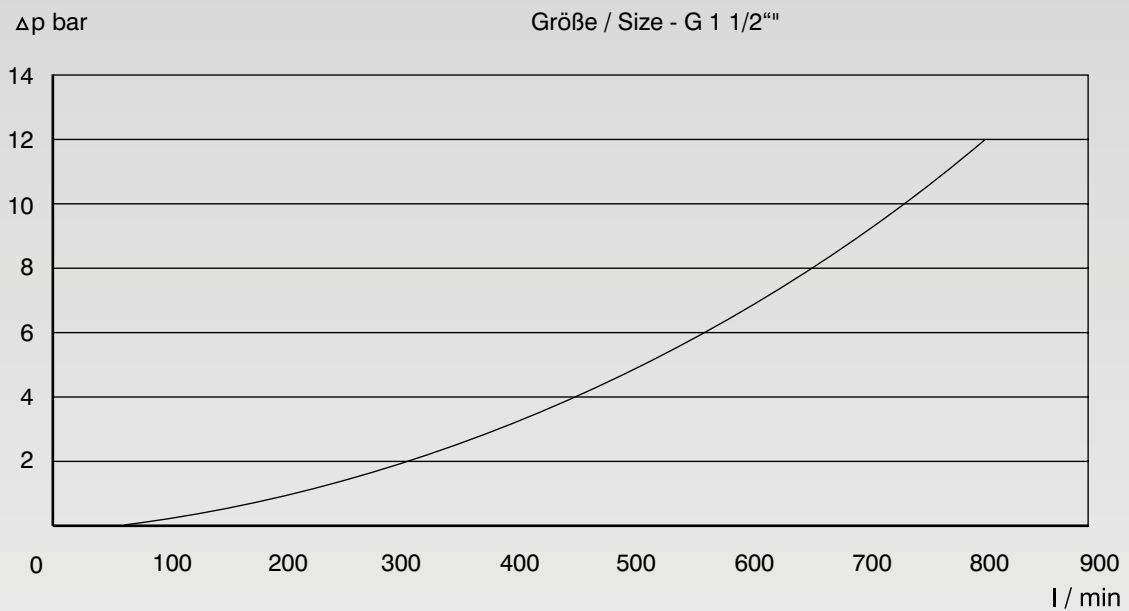
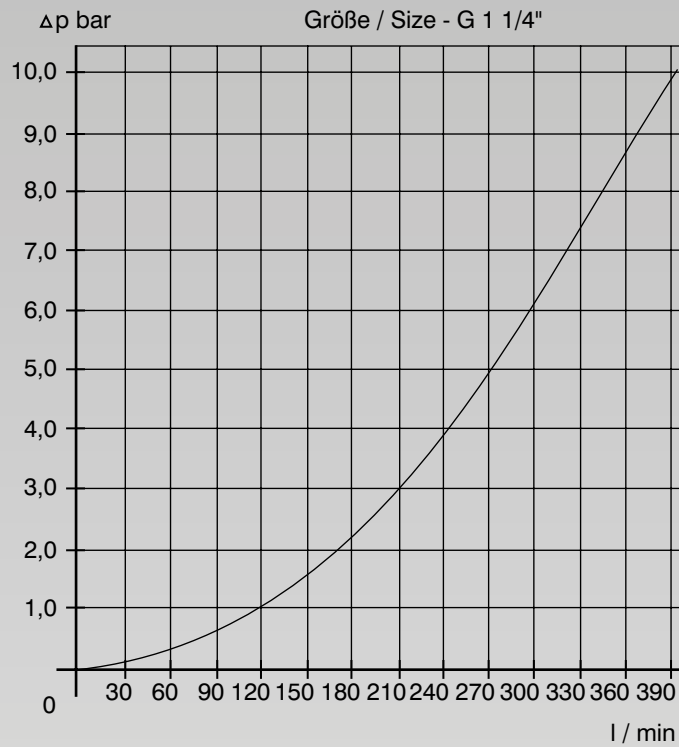

HOCHDRUCK- SCHRAUBKUPPLUNGEN - TYP: HSK HIGH PRESSURE SCREW COUPLINGS - TYPE: HSK



Anschluss-Innengewinde: BSP - Zylindrisch
DIN / ISO 228

Female Thread: BSP - Parallel
DIN / ISO 228

DN	Druck Pressure PB	Gewinde Thread G	Ca. Maße Approx. Dimensions							Bestellzeichen Order-Code Muffe / Female	Brutto-Preis Gross-Price Euro (€)
			D	L	L1	L2	L3	SW1	SW2		
06	750	1/4"	30	84,0	68,0		12,5		22	HSK-M-G 1/4"	104,65
10	650	3/8"	40	89,5	75,0		12,5		27	HSK-M-G 3/8"	104,65
12,5	650	1/2"	45	102,0	86,5		15,0		34	HSK-M-G 1/2"	110,45
20	500	3/4"	55	121,0	105,0		16,5		41	HSK-M-G 3/4"	158,75
25	460	1"	60	136,0	120,0		19,0		50	HSK-M-G 1"	215,60
31,5	400	1 1/4"	80	167,0	153,0		21,5		65	HSK-M-G 1 1/4"	728,60
38	360	1 1/2"	98	190,0	170,0		22,5		75	HSK-M-G 1 1/2"	947,00

DN	Druck Pressure PB	Gewinde Thread G	Ca. Maße Approx. Dimensions							Bestellzeichen Order-Code Stecker / Male	Brutto-Preis Gross-Price Euro (€)
			D	L	L1	L2	L3	SW1	SW2		
06	750	1/4"		84,0		43,0	12,5	25		HSK-S-G 1/4"	70,00
10	650	3/8"		89,5		48,0	12,5	32		HSK-S-G 3/8"	70,00
12,5	650	1/2"		102,0		53,0	15,0	34		HSK-S-G 1/2"	76,20
20	500	3/4"		121,0		63,0	16,5	46		HSK-S-G 3/4"	106,25
25	460	1"		136,0		72,0	19,0	50		HSK-S-G 1"	132,95
31,5	400	1 1/4"		167,0		86,0	21,5	65		HSK-S-G 1 1/4"	379,95
38	360	1 1/2"		190,0		95,0	22,5	80		HSK-S-G 1 1/2"	489,00

Unter Restdruck kuppelbar, wie folgt: Größe 1/4", 3/8", 1/2" = max. 10 bar Restdruck;
3/4", 1" = max. 5 bar Restdruck; 1 1/4", 1 1/2" = max. 3 bar Restdruck

Technische Daten (Standardausführung)

Werkstoff: V4a = AISI 316, Dichtungen aus FPM (Viton), Stützring aus PTFE
Verwendbarkeit: Hydraulikflüssigkeiten auf Mineralöl- und Glycolbasis, Luft und Wasser mit
Korrosionsschutz
Temperaturbereich: -20°C bis +200°C
Platzdruck: 2,5 fache Sicherheit gegen Arbeitsdruck

Connecting and Disconnecting under Residual Pressure, as follows: size 1/4", 3/8", 1/2" =
max. 10 bar residual pressure; 3/4", 1" = max. 5 bar residual pressure, 1 1/4", 1 1/2" = max. 3 bar
residual pressure

Technical Data (Standard Version)

Material: V4a = AISI 316, Sealings from FPM (Viton), Back-up Ring from PTFE
Utilization: Hydraulic Fluids on Mineral Oil and Glycol Base, Air and Water with Corrosion
Protection
Temperature Range: -20°C to +200°C
Burst Pressure: 2,5 times Working Pressure



ZUBEHÖR ZU HOCHDRUCK- SCHRAUBKUPPLUNGEN - TYP: HSK

ACCESSORIES FOR
HIGH PRESSURE SCREW COUPLINGS - TYPE: HSK



Baugröße Size DN	Ca. Maße Approx. Dimensions		Bestellzeichen Order-Code Muffe / Female	Brutto-Preis Gross-Price Euro (€)
	D	L		
10,0	40,0	20	SS-HSKM-10	12,95
12,5	45,0	22	SS-HSKM-12,5	15,60
20,0	54,5	27	SS-HSKM-20	20,65
25,0	60,0	33	SS-HSKM-25	25,80
31,5	79,0	38	SS-HSKM-31,5	33,60
38,0	98,0	45	SS-HSKM-38	92,00

ZUBEHÖR ZU HOCHDRUCK-
SCHRAUBKUPPLUNGEN - TYP: HSK
ACCESSORIES FOR
HIGH PRESSURE SCREW COUPLINGS - TYPE: HSK

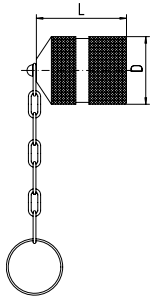

Aluminium-Staubschutz
Verschlusskappe für Stecker

Aluminium Dust Protection
Dust Cap for Male

Baugröße Size DN	Ca. Maße Approx. Dimensions		Bestellzeichen Order-Code Stecker / Male	Brutto-Preis Gross-Price Euro (€)
	D	L		
10,0	35	46,5	SS-HSKS-10	18,20
12,5	38	51,0	SS-HSKS-12,5	20,65
20,0	50	60,5	SS-HSKS-20	25,80
25,0	58	67,0	SS-HSKS-25	29,70
31,5	74	81,0	SS-HSKS-31,5	38,50
38,0	85	100,0	SS-HSKS-38	68,00



PH-Schnellkupplungen und Schraubkupplungen werden aus Edelstahl V4A - AISI 316 für allgemeine industrielle Anwendungen hergestellt.

Der gesamte Bereich der Abmessungen und Leistungsdaten erstreckt sich von 1/8" (DN 04) bis 2" (DN 51).

> **Maximaler Betriebsdruck:**

Siehe Tabellen der einzelnen Serien auf den jeweiligen Datenblättern.

> **Maximale Betriebstemperatur:**

Siehe Tabellen der einzelnen Serien auf den jeweiligen Datenblättern.

Einsatz

Die geforderte Leistung und Lebensdauer der Schnellkupplungen wird nur dann erreicht, wenn sie unterhalb der maximalen Temperatur- und Druckwerte aus den einzelnen Datenblättern und entsprechend den Tabellen für die chemische Kompatibilität der Werkstoffe mit den verschiedenen Medien verwendet werden.

PH übernimmt keine Haftung für direkte oder mittelbare Schäden, die Personen, Sachen oder Tiere durch eine falsche Verwendung der Produkte erleiden könnten.

Reinigung

Eine Schnellkupplung mit doppeltem Absperrventil kann den Fluss in den Hohlraum des Ventils blockieren, wenn es in der geschlossenen Position gehalten wird. Wenn die Schnellkupplung mit gefährlichen Medien verwendet worden ist, muss sie dekontaminiert werden, bevor mit dem Zerlegen für die Reinigung begonnen wird. Alle Personen, die mit der Wartung von Schnellkupplungen befasst sind, müssen geeignete persönliche Schutzausrüstung, z.B. Handschuhe, Schürzen, Visiere, Helme usw. tragen.

Austausch von Dichtungen

PH-Schnellkupplungen sind mit einem doppelten Dichtungssystem ausgestattet, bei dem eine pressgeformte Dichtung als Kegeldichtung eingesetzt wird. Gegenüber den eher herkömmlichen Systemen, deren Dichtungen nur aus O-Ringen bestehen, zeichnet sich diese Lösung dadurch aus, dass ein Herausdrücken der Dichtung zuverlässig verhindert wird und weniger Verschleiß an den einzelnen Komponenten auftritt, wodurch die Dichtung eine längere Lebensdauer erreicht. Der Ventilkörper ist im Inneren der Kupplung mit einem kleinen elastischen Ring (aus Edelstahl AISI 316) befestigt, der mit einem speziellen Verschlusswerkzeug angezogen wird. Wegen der besonderen Eigenschaften der Ventilkörper und Dichtungen empfehlen wir Ihnen,

PH Quick Release and Screw couplings are manufactured in Stainless Steel grade AISI 316 for industrial applications in general.

The complete range of dimensions and performances includes from 1/8" (DN 04) up to 2" (DN 50).

> **Maximum Operative Pressure:**

See the tables of every series in its relative technical data sheet.

> **Maximum Operative Temperature:**

See the tables of every series in its relative technical data sheet.

Use

The requested performances and the maximum life of the Quick Couplings are obtained only if they are used between the maximum temperature and pressure values as you can see in the single technical data sheet, and according to the chemical compatibility materials tables, based on the operative media.

PH declines every liability in reference to direct or un-direct damages which could affect people, things or animals due to a wrong use of products.

Cleaning

A double shut-off valve Quick Coupling could block the flow into the valve hollow when it is held in closing position. If the Quick Coupling has been used with dangerous media it must be decontaminated before starting the disassembly for cleaning. All people involved in the Quick Coupling maintenance works must dress proper security systems like gloves, aprons, steam faceplates, helmets, etc..

Replacement of Seals

PH Quick Couplings are designed and built with a double seal system, which provides the use of a pressed seal on the poppet sealing. With respect to the more traditional systems, whose seals are made by O-Rings only, this solution guarantees an absolute anti-extrusion system, a less wear of single components which means a more duration of the seal. The valve body is fixed inside the coupling through a small elastic ring (made of AISI 316 Stainless Steel) which is blocked by a special closing tool. Due to the particular features of the valve bodies

sich direkt an unseren technischen Kundendienst zu richten, der alle beschädigten Komponenten prüft und ggf. austauscht bzw. gegen Kostenvorschlag repariert.

PH haftet nicht für Kupplungen, an denen Dritte Eingriffe oder Reparaturen vorgenommen haben.

Installation

- Nehmen Sie die Schutzabdeckungen aus Kunststoff von den Gewinden erst ab, wenn die Kupplung zur Installation bereit ist. So wird verhindert, dass Fremdkörper in die Gewinde und Kupplungen gelangen.
- Verwenden Sie empfohlene Schmiermittel für Gewinde (wie z.B. Gleitmo 810 oder High Tech Paste ASW 040 P; siehe Rubrik 12) bei der Montage von Verbindungsarten zur Kupplung.
- Montieren Sie die fixierten Kupplungen mit einem geeigneten Werkzeug.
- Nehmen Sie niemals Montagearbeiten oder Änderungen an Schnellkupplungen vor, solange diese unter Druck stehen.

Konservierung

Die Kupplungen werden in einer geeigneten Verpackung geliefert, um sie vor Schäden auf dem Transportweg zu schützen. Falls die Kupplungen nicht innerhalb kürzerer Zeit nach der Lieferung verwendet werden, wird empfohlen, sie in einem gut belüfteten Raum zu lagern. Lagern Sie die Kupplungen nicht in der Nähe von Wärmequellen oder an Stellen, wo höhere Konzentrationen scheuernder Stäube vorkommen. Achten Sie darauf, dass die Schutzabdeckungen aus Kunststoff niemals abgenommen werden.

Lagern Sie Kupplungen nicht im gekuppelten Zustand (Muffe mit Stecker).
Alle Bauteile müssen grundsätzlich im ungekuppelten Zustand gelagert werden.

and seals, we recommend you to contact directly our technical staff, which provides possibilities to change all the damaged components on request against repair charges.

PH declines every responsibility to the couplings which are repaired or touched by third parties.

Installation

- *Remove all the plastic protections of the threaded ends only when the coupling is ready for installation. It prevents the threads and couplings from every entrance of external bodies.*
- *Use recommended lubricants on the threads (for example use Gleitmo 810 or High Tech Paste ASW 040 P; see category 12) for the assembly of any connector.*
- *Block the couplings with a proper tool, acting on the hexagonal side.*
- *Never perform actions of assembly or modifications to the Quick Couplings when they are under pressure.*

Conservation

The Couplings are delivered in a proper package to protect them by every risk or damage during the transportation. If the couplings are not used in a short period after the delivery, it is recommended to store them in a well aerated and lift place. Do not store the couplings close to heat sources or places with a big concentration of abrasive dust and be sure that plastic protections are never removed.

Do not store shut-off couplings assembled (male + female).
All bodies must be always stored not coupled.



Wichtige Hinweise...

- A. Achten Sie beim Verbinden und Trennen der beiden Kupplungselemente auf die axiale Ausrichtung.
- B. Nutzen Sie Kupplungen niemals als Drehgelenk.
- C. Installieren Sie die Kupplungen niemals in Systemen, in denen Temperaturen auftreten, die den maximalen Temperaturbereich über- bzw. unterschreiten.
- D. Schmieren Sie die Kupplungsgehäuse regelmäßig mit einem geeigneten Schmiermittel (wie z.B. Gleitmo 810 oder High Tech Paste ASW 040 P; siehe Rubrik 12), das für den Kontakt mit dem Betriebsmedium geeignet ist.
- E. Drehen Sie die Kupplung niemals in das Gegenstück, wenn das System unter Druck steht.
- F. Montieren Sie keine Bauteile in oder an die gekuppelten Verbindungen.
- G. Fixieren Sie die direkt mit den Kupplungen verbundenen Leitungen oder andere Einrichtungen, um Belastungen in radialer Richtung zu vermeiden.
- H. Verwenden Sie geeignete Schutzmaßnahmen oder Staubschutzelemente, wenn einzelne Komponenten nicht verbunden sind.
- I. Installieren Sie Filter im Kreislauf des Systems. Die Filter müssen regelmäßig gewartet werden, bevor die Kupplungen installiert werden.
- J. PH haftet nicht für Schäden, Unfälle oder andere unerwartete Folgen durch einen nicht sachgemäßen Einsatz der Kupplungen. PH haftet ebenfalls nicht für Schäden, die von Personen verursacht werden, die keine Befugnis zur Arbeit am System haben. PH haftet nicht für die Nichtbeachtung von Anweisungen und Verfahren im Anwendungsfeld der Kupplungen.

You have...

- A. *to axially line the male and female valves during the coupling action and release action.*
- B. *to never use the couplings as rotating joint.*
- C. *to never install the couplings in systems with a major or less temperature than the maximum tolerance expected.*
- D. *to periodically lubricate the coupling bodies with proper lubricants (for example use Gleitmo 810 or High Tech Paste ASW 040 P; see category 12), suitable for contact with the operative media.*
- E. *to never rotate the male body into the female one, when the system is under pressure.*
- F. *to not insert external parts additionally to the male or female bodies when they are coupled.*
- G. *to relevantly support the pipelines or other devices directly connected to the coupling, in order to avoid a radial excessive load.*
- H. *to use proper protections or anti-dust caps when single components are not coupled.*
- I. *to install filters on the system flow-line. The filters have to be maintained periodically before installing the couplings.*
- J. *PH will never be responsible for damages, accidents or every not expected consequences related with a not proper use of Couplings. PH at the same time is not responsible for damages caused by people who are not allowed to work with the system. PH will not be liable for the not observance (even partial) of instructions and procedures included into the couplings use and maintenance manual.*



CENTRALA ELBLĄG

Ul. Rawska 19B
82-300 Elbląg

tel. /+48/ 55 625 51 00

fax /+48/ 55 625 51 01

Dział Handlowy

tel. /+48/ 55 625 51 51

elblag@hydropress.pl

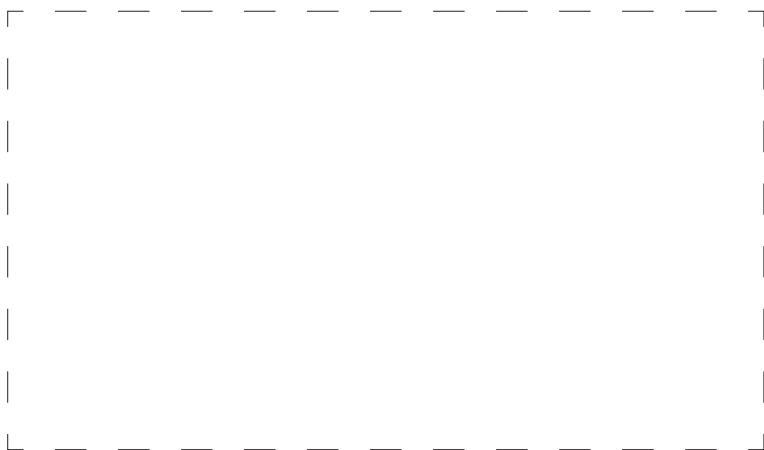

www.hydropress.pl

ODDZIAŁ GDAŃSK

tel. /+48/ 55 625 51 21

fax /+48/ 55 625 51 22

ODDZIAŁ RUMIA

tel. /+48/ 58 679 34 15

fax /+48/ 55 625 51 25

ODDZIAŁ TYCHY

tel. /+48/ 32 787 52 88

fax /+48/ 55 625 51 38

ODDZIAŁ OLSZTYN

tel. /+48/ 89 532 01 05

fax /+48/ 89 715 21 42

ODDZIAŁ WARSZAWA

tel. /+48/ 22 468 86 97

fax /+48/ 55 625 51 32

BIURO HANDLOWE WROCŁAW

tel. /+48/ 782 838 000

fax /+48/ 55 625 51 35

BIURO HANDLOWE KIELCE

tel. /+48/ 885 995 501

fax /+48/ 55 625 51 01

BIURO HANDLOWE KRAKÓW

tel. /+48/ 885 995 019

fax /+48/ 55 625 51 01

BIURO HANDLOWE OPOLE

tel. /+48/ 885 995 011

fax /+48/ 55 625 51 01

BIURO HANDLOWE BYDGOSZCZ

tel. /+48/ 790 222 771

fax /+48/ 55 625 51 01