

ZAWORY DO ZABUDOWY  
PŁYTOWEJ CETOP  
ROZDZIELACZE PŁYTOWE  
VICKERS NG10

# Solenoid Operated Directional Valve

DG4V-5-20 Design

## General description

A range of four-port solenoid operated directional control valves with four-land spool design to facilitate provision of smooth, variable valve response speeds.

The range includes:

- AC and DC wet-armature solenoid options with ISO 4400 (DIN 43650) electrical connections and manual overrides.
- Variable speed changeover potential in all DC models; see "Response Times" section.
- Many spool types; in spring-offset, spring-centered and detented arrangements.
- Compact, cost effective system design when used with Eaton® SystemStak™ valves and subplates.

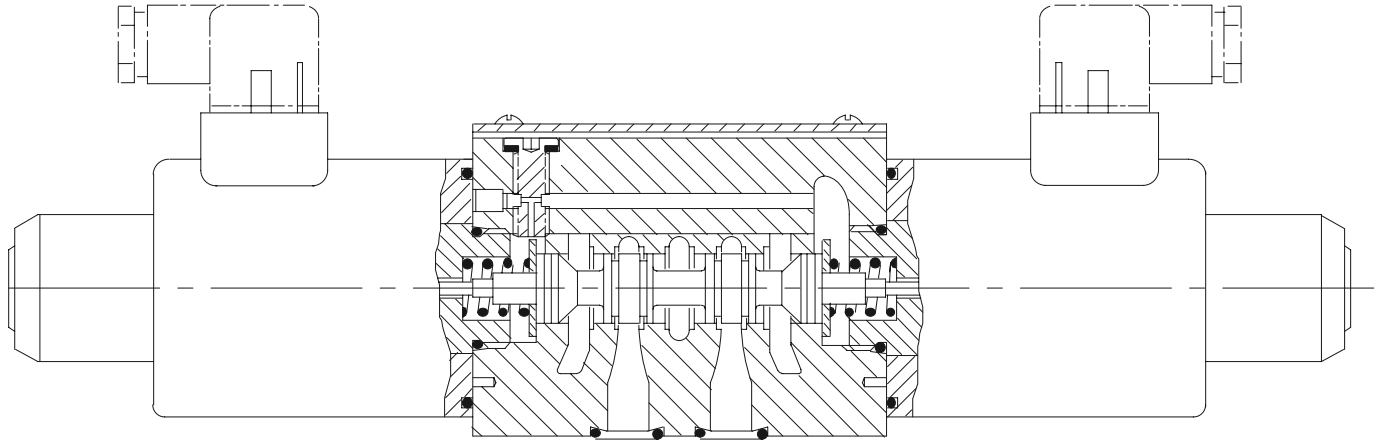

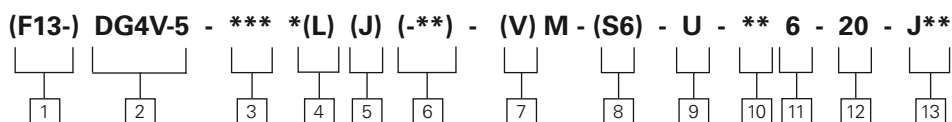

## 1 Prefix, fluid compatibility

**Blank** – AC or DC-voltage models for petroleum oils, water-in-oil (invert) emulsions or phosphate esters.

AC - voltage models for water glycols.

**F13** – DC-voltage models for water glycols.

## 2 Model Series

**4** – Solenoid operated

**V** – Pressure rating 315 bar (4568 psi) on P, A & B parts

**5** – ISO4401 Size 05

## 3 Spool type

See “Functional Symbols” section

## 4 Spool spring arrangement

**A** – Spring offset to A. Single end.

**AL** – As ‘A’, but left hand build

**B** – Spring centered. Single end.

**BL** – As ‘B’, but left hand build

**C** – Spring centered. Double End.

**N** – No spring detented. Double end.

## 5 Spool design

**Blank** – “0A” DC-valves and all AC valves except “8B(L)” and “8C” spool/ spring arrangements.

**J** – All DC valves except “0A” spool/ spring arrangements. AC valves with “8B(L)” and “8C” spool/spring arrangements.

## 6 Manual override option

**Blank** – Standard plain override(s) in solenoid end(s) only ▼

**H** – Water-resistant override(s) in solenoid end(s) ▼

**W** – Twist and lock override in solenoid end only

**Z** – No overrides at either end

Omit for standard plain override(s) in solenoid end(s) only ▼

▼ No override in non-solenoid end of single-solenoid valves.

## 7 Solenoid energization identity

**V** – Solenoid “A” is at port A end and/or solenoid “B” is at port B end, independent of spool type

Note: Used to select the identification of the solenoid. Refer to page 4.

## 8 Spool position indicator switch

**Blank** – No spool position monitoring switch.

**S7** – Spool position monitoring switch. Single solenoid valves only

## 9 Coil Type

**U** – ISO 4400 (DIN 43650) mounting(s) without plug(s)

**U1** – ISO 4400 with fitted DIN plug

**U6** – ISO 4400 with fitted DIN plug with lights

**KU** – Flying leads from top of the solenoid

**KUM5LD3** – M12 connector with diode lights

**KUP10** – Flying leads metri-pack connector (male)

**KUP4** – Junior timer (AMP) connector

**KUP5D2** – Moulded Deutsch connector with diode

**KUP6D2** – Flying lead with Deutsch connector with diode

## 10 Coil rating

**A** – 110V AC 50

**C** – 220V AC 50

**ED** – 240V AC 50

**EK** – 115V AC 60

**EH** – 230V AC 60

**G** – 12V DC

**H** – 24V DC

**HL** – 24V DC (32W)

**OJ** – 48V DC

**P** – 110V DC

**DJ** – 98V DC (42W)

**EJ** – 196V DC (43W)

**EO** – 205V DC (43W)

**KK** – 48V AC 50HZ

**NN** – 24V AC 50HZ

## 11 Tank Pressure Rating

**6** – 160 Bar Tank Pressure Rating

## 12 Design number

Subject to change. Installation dimensions unaltered for design numbers 20 to 29 inclusive.

## 13 Spool speed control

**J06** – 0,6 mm orifice

**J08** – 0,8 mm orifice

**J10** – 1,0 mm orifice

**J12** – 1,2 mm orifice

**J99** – no orifice. Must be specified where future fitting of orifice is required, see page A.11, “Spool Speed Control Orifice”

The valve function schematics apply to both U.S. and European valves.

### DG4V-5-\*N valves

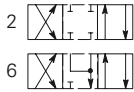

### DG4V-5-\*A valves

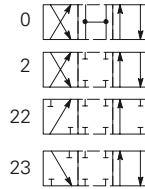

### DG4V-5-\*AL valves

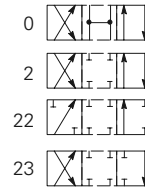

### DG4V-5-\*C valves

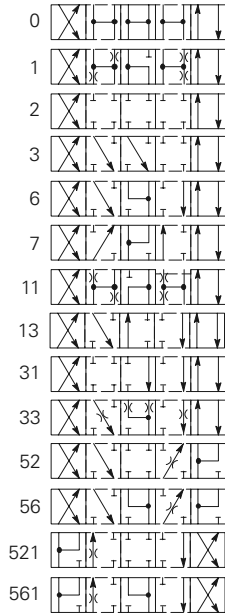

### DG4V-5-\*B valves

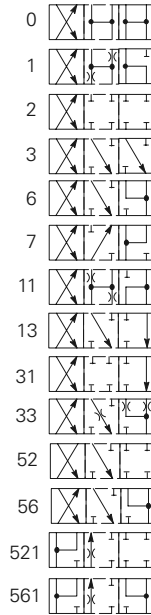

### DG4V-5-\*BL valves

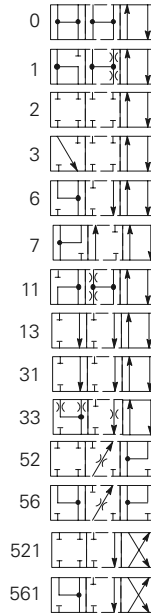

### DG4V-5-8CV valves

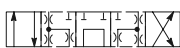

### DG4V-5-8BLV valves

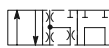

### DG4V-5-8BV valves

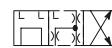

## Solenoid Identified Standards

### U.S. Solenoid Standard

Double solenoid valves, two position, detented

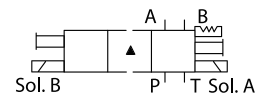

Double solenoid valves, spring centered

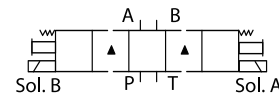

Single solenoid valves, solenoid at port A end

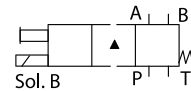

Single solenoid valves, solenoid at port B end

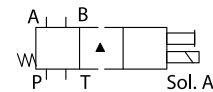

▲ Transient condition only

Feature	DG4V-5	
<b>Pressure Limits</b>		
P, A and B ports	315 bar (4500 psi)	
T port: T <sub>A</sub>	120 bar (1750 psi) for AC Sol.	
T <sub>B</sub>	160 bar (2325 psi) for DC Sol.	
Flow rating	See performance data	
Relative duty factor	Continuous; ED = 100%	
Type of protection: ISO 4400 coils with plug fitted correctly	IEC 144 class IP65	
Coil winding	Class H	
Lead wires (coils type F***)	Class H	
Coil encapsulation	Class F	
<b>Permissible voltage fluctuation:</b>		
Maximum	Refer to temperature limits.	
Minimum	90% rated	
<b>Typical response times at 100% rated volts measured from application/removal of voltage to full spool displacement of "2C" spool at:</b>		
Flow rate P-A, B-T	40 l/min (10.6 USgpm)	
Pressure	175 bar (2537 psi)	
AC (~) energizing	30 ms	
AC (~) de-energizing	40 ms	
DC (=) energizing	120 ms ■	
DC (=) de-energizing	45 ms ■*	
<b>Power consumption, AC solenoids (for coils listed in model code).</b>		
	<b>Initial VA (RMS)▲</b>	<b>Holding VA (RMS)</b>
<b>Full power coils:</b>		
Dual frequency coils at 50 Hz	700	105
Dual frequency coils at 60 HZ	105	130
<b>Power consumption, DC solenoids at rated voltage and 20 C (68 F).</b>		
<b>Full power coils:</b>		
Others	38W	
Model type "HL"	32W	
<b>Mass, Approx. kg (lb)</b>		
Single solenoid models, AC coils	4,0 (8.8)	
Single solenoid models, DC coils	4,8 (10.6)	
Double solenoid models, AC coils	4,5 (9.9)	
Double solenoid models, DC coils	6,3 (13.9)	
<b>Temperature Limits</b>		
Minimum ambient	-20 °C (-4 °F)	
Maximum ambient:		
AC 50 Hz valves	50 °C (122 °F)	
AC 60 Hz valves	40 °C (104 °F)	
DC valves	70 °C (158 °F)	

### Spool Speed Control Orifice

For fine tuning of valve spool speed. Only applicable to valves already fitted with an orifice or blank plug, see model code, page 3.

### Orifice Kit

Orifice kits must be ordered separately, part number 02-350116. Kit comprises 1 off each as per code 13 on page 3:

\* In pure switched conditions, devoid of the effects of any suppression diodes and full-wave rectifiers.

■ DG4V-5-2CJ valves. Longer response times can be obtained by fitting an orifice plug in a special pilot port, standard in all bodies. An orifice kit 459065, containing a selection of plugs of differing orifice size, can be ordered separately. Ask your Eaton representative for details.

▲ 1<sup>st</sup> half cycle; armature fully retracted.

## Spool Position Indicator Models

Spool/spring arrangement types 0A, 2A, 2AJ , 22A, 22AJ, 35A, 35AJ, 0BJ, 2BJ, 6BJ

### DC model type "S7"



This product has been designed and tested to meet specific standards outlined in the European Electromagnetic Compatibility Directive (EMC) 2004/108/EC. For instructions on installation requirements to achieve effective protection levels see this leaflet and the Installation Wiring Practices for Vickers Electronic Products leaflet 2468. Wiring practices relevant to this Directive are indicated by

Electromagnetic Compatibility (EMC).

Input:

Supply voltage	20-32 VDC
Reverse Pol. Protection	Yes
	outputs with alternating function - PNP

Output:

Max output load	<=400mA ; Duty Ratio 100%
Short Circuit Protection	Yes
Hysteresis	<=0.05mm
Electrical connector	M12x1 4-Pole
Thermal shift	<=±0.1mm

Pin Connections;

Pin 1	+ Supply
Pin 2	Normal Closed
Pin 3	0V
Pin 4	Normal Open

EMC Protection	DIN EN 61000-6-1/2/3/4, Aug 2002
Humidity	0-95% rel. (nach DIN 40040)
Protection Class	IP65 DIN 40050
Vibration 0-500Hz	Max. 20g
Shock	Max. 50g

## Wiring Connections



### Warning

All power must be switched off before connecting or disconnecting any plugs.

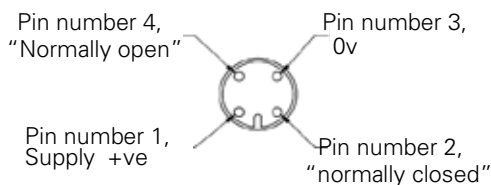
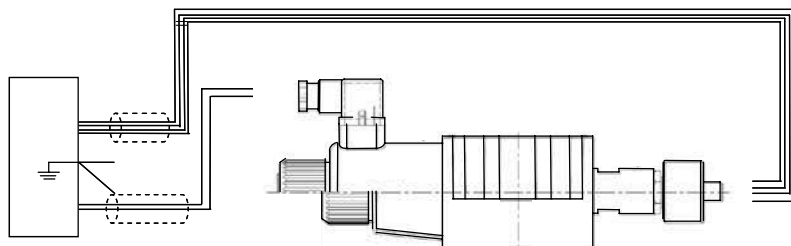

Customer protective ground connection



### WARNING: Electromagnetic Compatibility (EMC)

It is necessary to ensure that the unit is wired up in accordance with the connection arrangements shown above. For effective protection the user's electrical cabinet, the valve subplate or manifold and the cable screens should be connected to efficient ground points. In all cases both valve and cable should be kept as far away as possible from any sources of electromagnetic radiation such as cables carrying heavy current, relays and certain kinds of portable radio transmitters, etc. Difficult environments could mean that extra screening may be necessary to avoid the interference.



# Performance Data

Typical with mineral oil at 36 cSt (168.6 SUS) and a specific gravity of 0.87.

## Max. Flow Rates

Based on warm solenoid(s) operating at 10% below rated voltage.

Flow limits applicable to following usages:

1. All valves except those with types 22, 52, 56, 521 and 561 spools having simultaneous equal flow rates from P to A or B and from B or A to T.

2. Valves with type 22 spools having flow from P to A or B, the other being blocked. T is drained at all times.

3. Valves with types 52, 56, 521 and 561 spools having one service port connected to the full bore end of a 2:1 area ratio double-acting cylinder and the other service port to the annulus end.

4. Valves with type 23 spools having single flow from A or B to T, P and the other service port being blocked.

Consult Eaton with application details if any of the following are required:

- a) Single flow path, i.e. P to A, P to B, A to T or B to T.

- b) Substantially different simultaneous flow rates between P to A or B and B or A to T.
- c) Spools as in 3 above are to be used with cylinder ratios greater than about 3:1 at low flow rates or 2:1 at high flow rates.

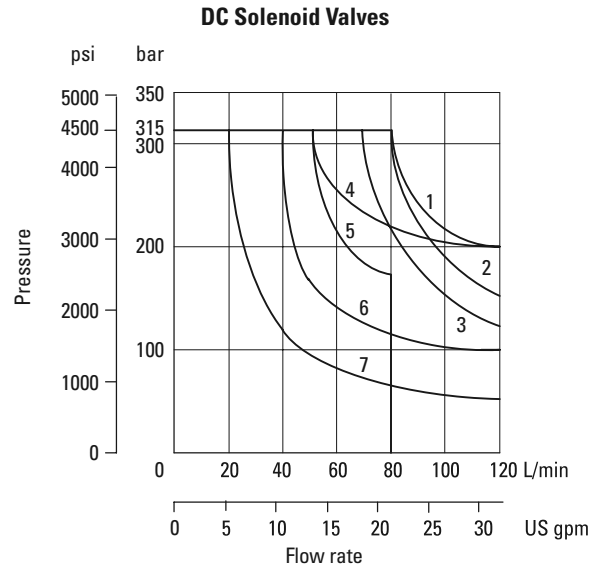
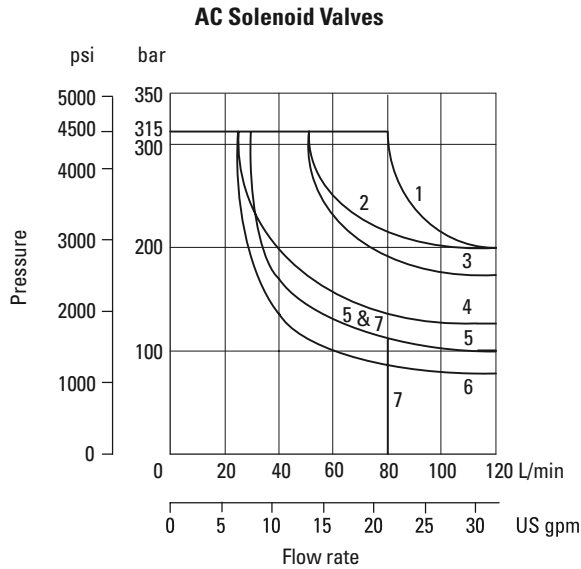

Spool/spring code	AC valve graph curve	DC valve graph curve
0A(L)	3	2
0B(L) & 0C	2	4
1B(L) & 1C	6	7
2A(L)	3	2
2B(L), 2C & 2N	1	1
3B(L), 3C, 6B(L) & 6C	4	6
6N	3	3
7B(L) & 7C	1	1
8B(L) & 8C	7	5
11B(L), 11C & 22A(L)	6	7
23A(L)	5	6
31B(L) & 31C	4	6
33B(L), 33C	3	6
52B(L), 52C, 56BL, 56C, 521B, 521C, 561B & 561C	4	6

**Pressure Drops** Typical with petroleum oil at 36 cSt (170 SUS) and a specific gravity of 0,87

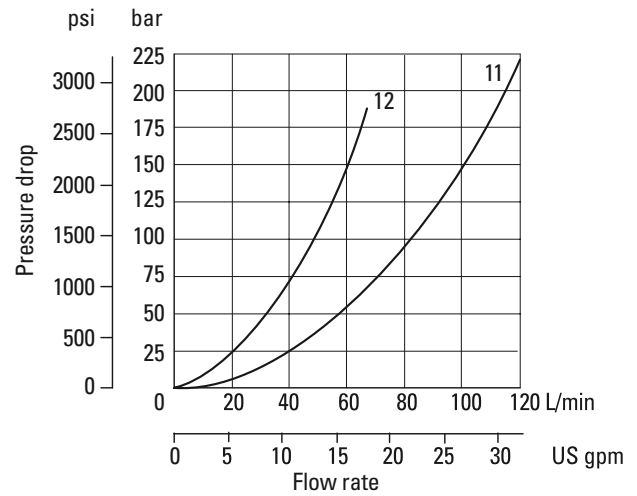
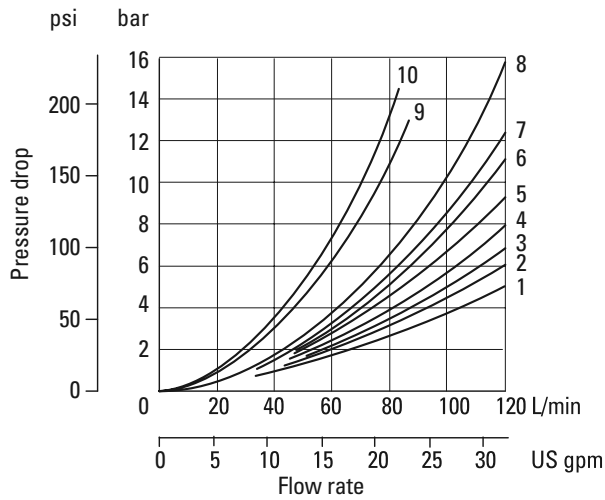

Spool/spring code	Spool positions covered	P to A	P to B	A to T	B to T	P to T	A to B or B to A
0A(L)	Both	2	2	4	5	–	–
0B(L) & 0C	De-energized	–	–	–	–	3t	–
	Energized	1	1	6	7	–	–
1B(L) & 1C	De-energized	–	–	–	–	6u	–
	Energized	1	2	6	4	–	–
2A(L)	Both	3	3	5	6	–	–
2B(L) & 2C	All	2	2	4	5	–	–
2N	Both	3	3	5	6	–	–
3B(L) & 3C	De-energized	–	–	5	–	–	–
	Energized	2	3	6	5	–	–
6B(L) & 6C	De-energized	–	–	5m	6u	–	–
	Energized	3	3	6	7	–	–
6N	Both	4	4	4	5	–	–
7B(L) & 7C	De-energized	3m	3u	–	–	–	5■
	Energized	2	2	5	6	–	–
8B(L) & 8C	All	2	2	7	8	8	–
11B(L) & 11C	De-energized	–	–	–	–	6m	–
	Energized	2	1	4	7	–	–
22A(L)	Both	3	3	–	–	–	–
23A(L)	Both	3	3	5	6	–	–
31B(L) & 31C	De-energized	–	–	–	6	–	–
	Energized	3	2	4	7	–	–
33B(L) & 33C	De-energized	–	–	12m	12u	–	–
	Energized	2	2	5	6	–	–
52BL & 52C	All	7m	8	4	–	–	9■
56BL & 56C	De-energized	–	–	8m	10u	–	–
	Energized	7m	8	6	–	–	9■
521B & 521C	All	8	7u	–	5	–	9■
561B & 561C	De-energized	–	–	10m	8u	–	–
	Energized	8	7u	–	7	–	9■

t A and B blocked u A blocked m B blocked ■ P blocked



# Installation Dimensions in mm (inches)

## AC Solenoid Models

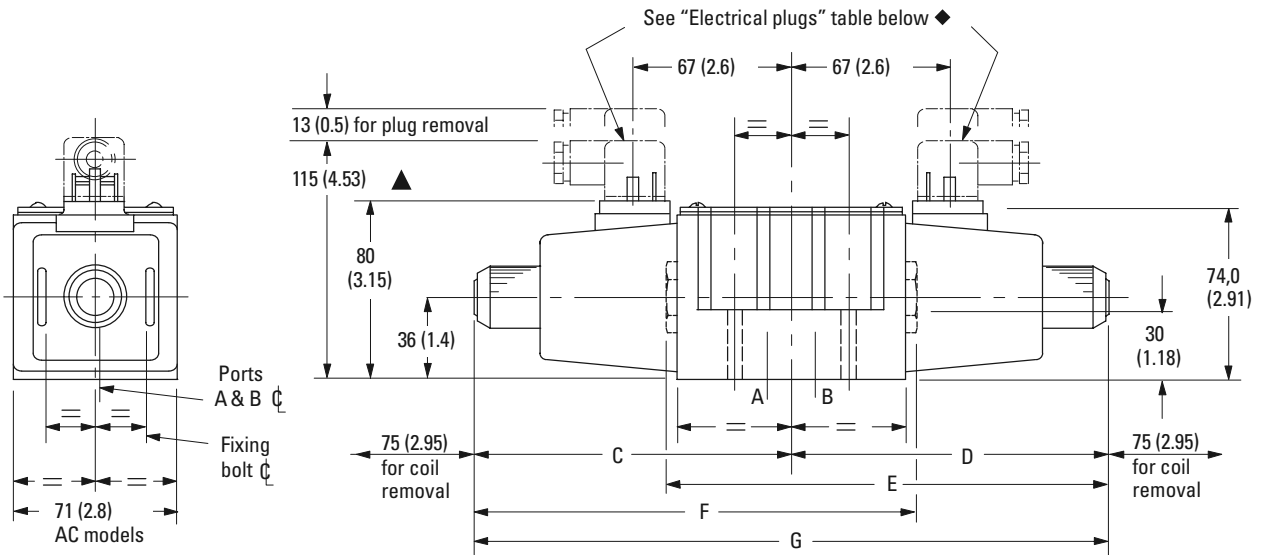

- ▲ May vary according to plug source.
- ◆ The cable entry can be repositioned at 90° intervals from the position shown. This is done by reassembling the contact holder into the appropriate position inside the plug housing.

Model	Solenoid at:	C	D	E	F	G
DG4V-5-*A(L)/B(L)(-Z)-(V)M	Port A end	123 (4.84)	–	–	182 (7.17)	–
	Port B end	–	123 (4.84)	182 (7.17)	–	–
DG4V-5-*C/N(-Z)-(V)M	Both ends	123 (4.84)	123 (4.84)	–	–	246 (9.68)
DG4V-5-*C/N-H-(V)M	Both ends	138 (5.43)	138 (5.43)	–	–	276 (10.87)

## DC Solenoid Models

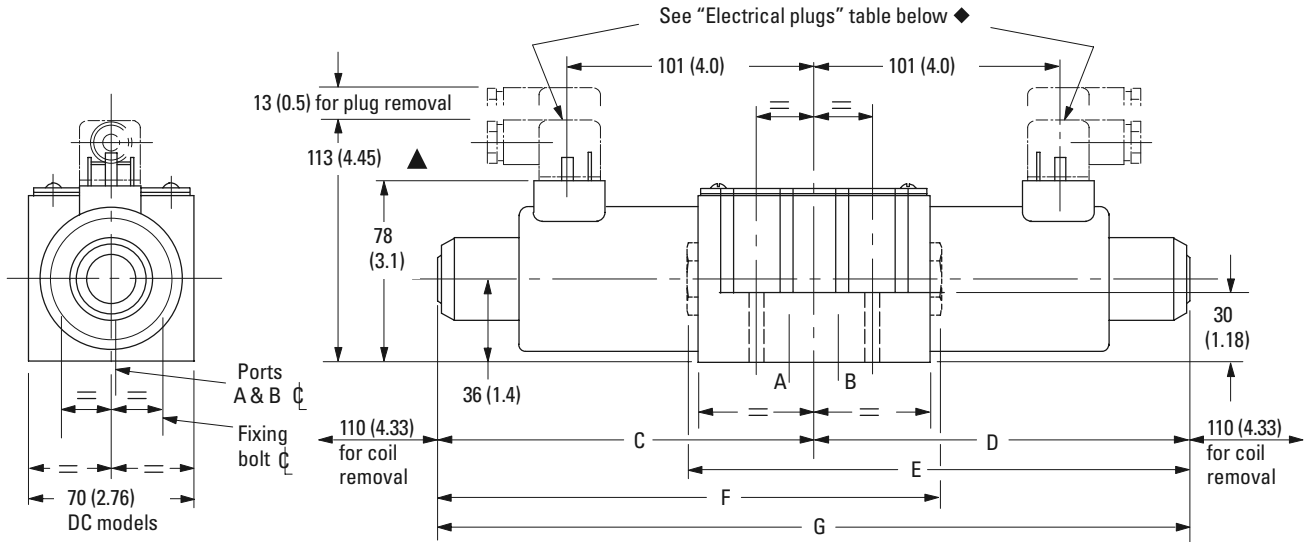

- ▲ May vary according to plug source.
- ◆ The cable entry can be repositioned at 90° intervals from the position shown. This is done by reassembling the contact holder into the appropriate position inside the plug housing.

Model	Solenoid at:	C	D	E	F	G
DG4V-5-*A(L)/B(L)(-Z)-(V)M	Port A end	156 (6.14)	–	–	215 (8.46)	–
	Port B end	–	156 (6.14)	215 (8.46)	–	–
DG4V-5-*C/N(-Z)-(V)M	Both ends	156 (6.14)	156 (6.14)	–	–	312 (12.28)
DG4V-5-*C/N-H-(V)M	Both ends	185 (7.28)	185 (7.28)	–	–	370 (14.57)

## Spool Position Indicator Switch Models

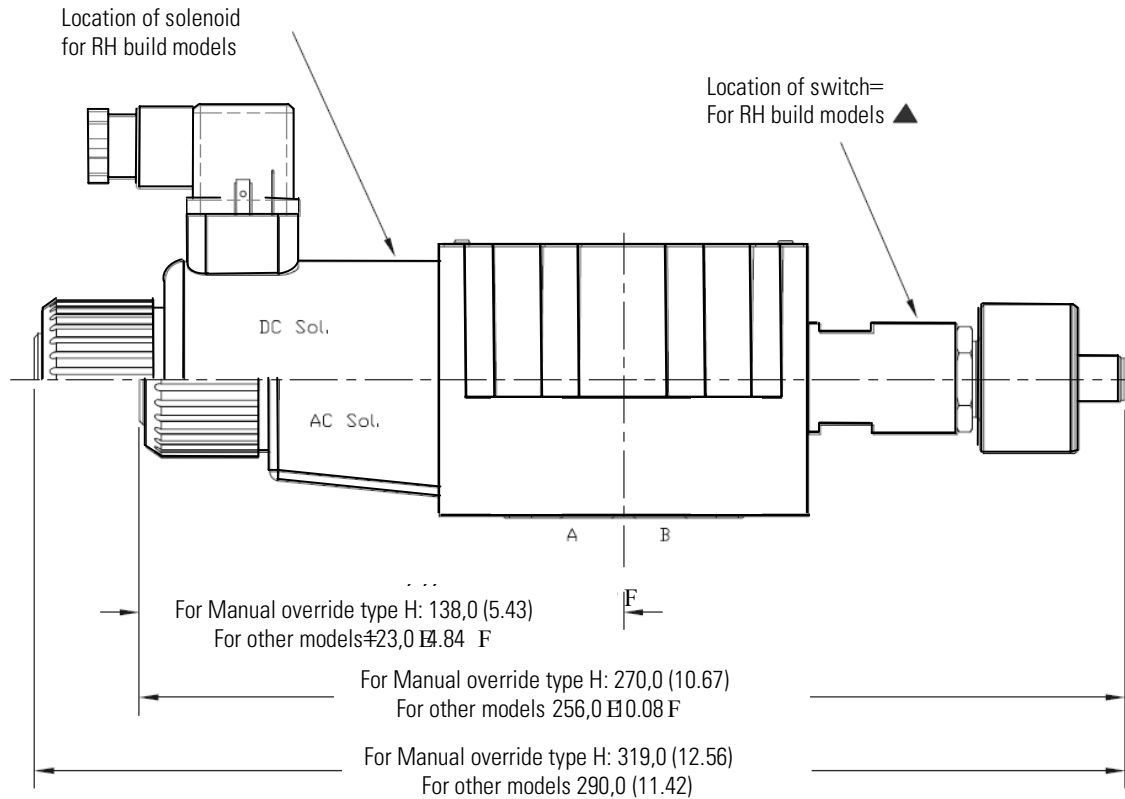

▲ For LH models ("L" in model code location 4) solenoid and switch locations are reversed

⚠ **Wiring:** See warning note on page 6

# Electrical Plugs and Connectors

## DIN 43650 Connector

Cable diameter range:

Wire section range:

Terminals:

Type of protection:

Connector can be positioned at 90° intervals on valve by re-assembling contact holder into appropriate position inside connector housing.

Connectors with and without indicator lights are available (order separately):

Ø6–10 mm (0.24–0.40)

Ø,5–1,5 mm<sup>2</sup>

(0.0008– 0.0023 in<sup>2</sup>)

Screw type

IEC144 class IP65, when plugs are fitted correctly to the valves with interface seals (supplied with plugs) in place.

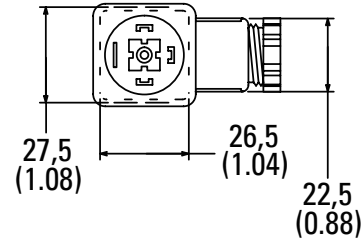
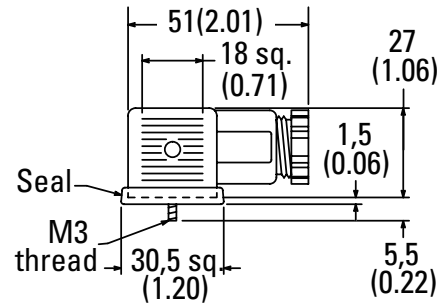

Receptacle	Voltage (AC or DC)	Part Numbers Gray – "A" sol.	Black – "B" sol.
U1 Coils without lights	–	710776	710775
U6 Coils with lights	12-24 100-125 200-240	977467 977469 977471	977466 977468 977470

## Connecters

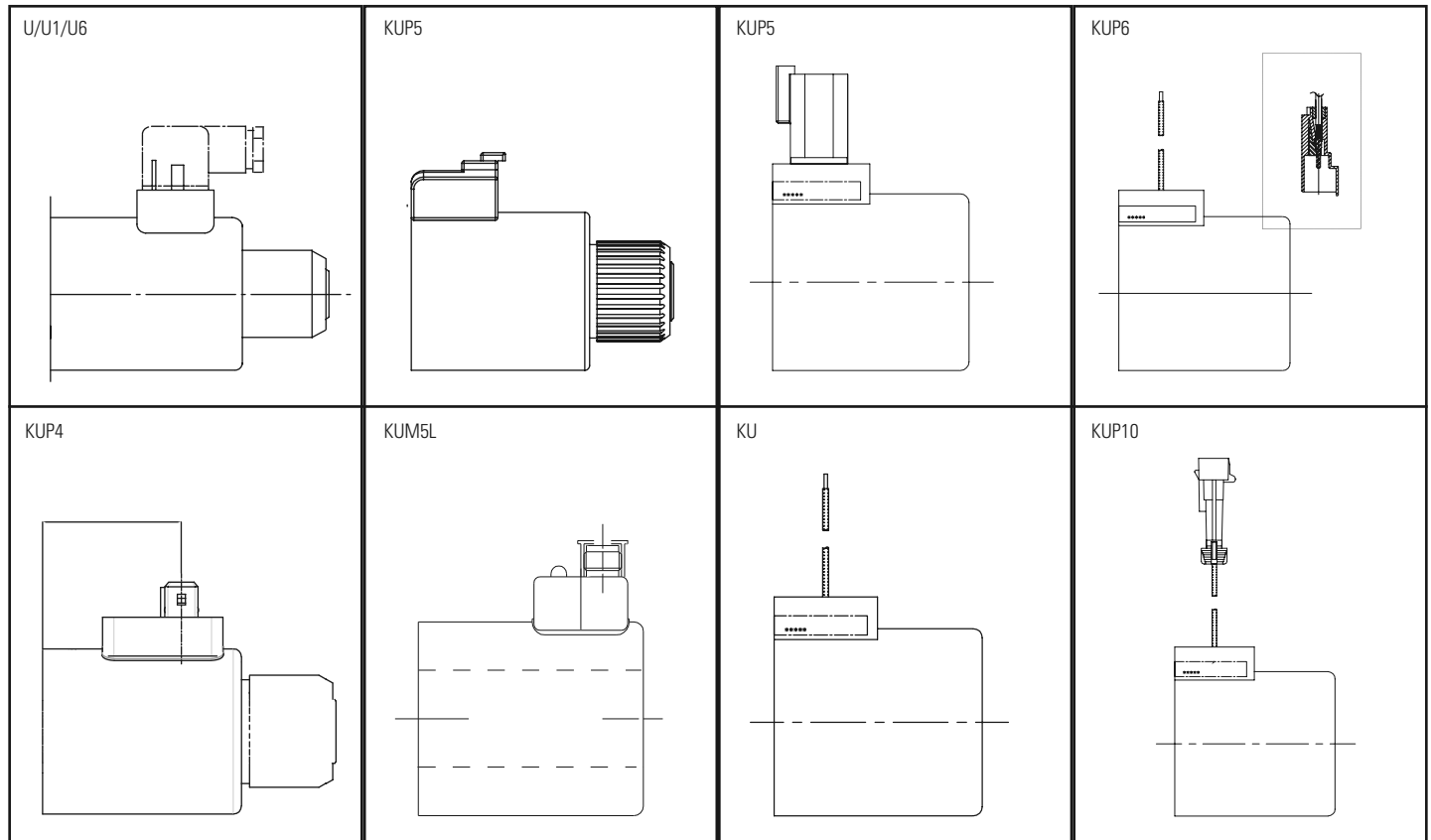

## **CENTRALA ELBLĄG**

Ul. Rawska 19B  
82-300 Elbląg

tel. /+48/ 55 625 51 00

fax /+48/ 55 625 51 01

### **Dział Handlowy**

tel. /+48/ 55 625 51 51

[elblag@hydropress.pl](mailto:elblag@hydropress.pl)



[www.hydropress.pl](http://www.hydropress.pl)

### **ODDZIAŁ GDAŃSK**

tel. /+48/ 55 625 51 21

fax /+48/ 55 625 51 22

### **ODDZIAŁ RUMIA**

tel. /+48/ 58 679 34 15

fax /+48/ 55 625 51 25

### **ODDZIAŁ TYCHY**

tel. /+48/ 32 787 52 88

fax /+48/ 55 625 51 38

### **ODDZIAŁ OLSZTYN**

tel. /+48/ 89 532 01 05

fax /+48/ 89 715 21 42

### **ODDZIAŁ WARSZAWA**

tel. /+48/ 22 468 86 97

fax /+48/ 55 625 51 32

### **BIURO WE WROCŁAWIU**

tel. /+48/ 782 838 000

fax /+48/ 55 625 51 35

### **BIURO W KIELCACH**

tel. /+48/ 885 995 501

fax /+48/ 55 625 51 01

### **BIURO W KRAKOWIE**

tel. /+48/ 885 995 019

fax /+48/ 55 625 51 01

### **BIURO W OPOLU**

tel. /+48/ 885 995 011

fax /+48/ 55 625 51 01

### **BIURO W BYDGOSZCZY**

tel. /+48/ 790 222 771

fax /+48/ 55 625 51 01

### **BIURO W BIAŁYMSTOKU**

tel. /+48/ 89 532 01 05

fax /+48/ 89 715 21 42

### **BIURO W ŁODZI**

tel. /+48/ 609 221 421

fax /+48/ 89 715 21 42