



# SZYBKOZŁĄCZA HYDRAULICZNE SERIA IRBO

# IRBOSERIES













INTERCHANGE > ISO 7241-1 "B"



Stucchi®



## TECHNICAL FEATURES AND OPTIONS

 <b>Interchange</b> ISO 7241-1 "B"	 <b>Sealing description</b> FKM (VITON®)	 <b>Connection system</b> Single acting sleeve
 <b>Available sizes</b> From 1/8" to 1"	 <b>Material</b> Brass	 <b>Available threads</b> BSP - NPT
 <b>Operating pressure</b> Up to 200 bar	 <b>Locking mechanism</b> Locking Ball system	 <b>Flow rate</b> Up to 200 L/Min
 <b>Temperature (°C)</b> -15° / + 180°	 <b>Valving style</b> Poppet	 <b>Connection under pressure</b> Connection: not allowed Disconnection: not allowed

## BENEFITS

- The poppet valve with elastomer seal provides maximum sealing of the couplings when disconnected.
- Shape of internal parts is designed to reduce turbulence and pressure drop.
- Superior corrosion resistance compared to Chrome 3.
- Compact slim design.
- Simple to use.

## HOW TO USE

- Before to connect, clean the mating surface of the couplings to avoid dirt inclusion in the circuit.
- To connect pull back the sleeve of the female coupling, align the female with the male coupling and push one into the other until both halves are fully connected and release the sleeve.
- To disconnect push back the sleeve of the female coupling, pull out the mating half.

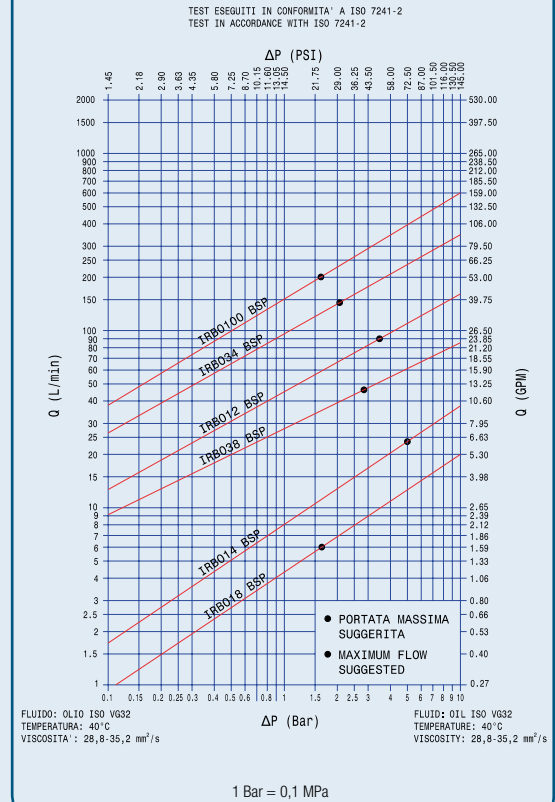

BackUp rings are designed to prevent extrusion and to avoid premature wearing of O-Ring.

Single acting sleeve: connection and disconnection by pulling back the sleeve

High number of locking balls to reduce the "brinelling" effect

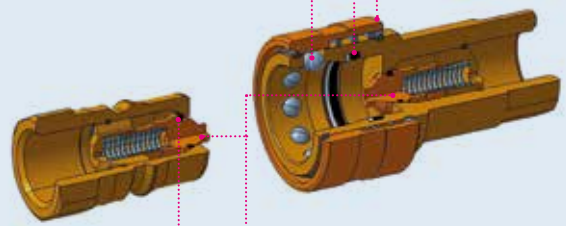

Valves with crimped seal to prevent extrusion at high flow rates

Poppet valves

## MAIN APPLICATIONS



ISO B

## PERFORMANCES

Size		Series/Size	Max. flow suggested		Connect force		Disconnect force		Spillage*
Inch	mm (ISO)		l/min	GPM	N	lbf	N	lbf	ml
1/8	5,0	IRB018	6	1,59	75	16,88	35	7,88	0,18
1/4	6,3	IRB014	24	6,36	60	13,50	30	6,75	0,33
3/8	10,0	IRB038	46	12,19	95	21,38	35	7,88	2,20
1/2	12,5	IRB012	90	23,85	95	21,38	35	7,88	3,00
3/4	20,0	IRB034	148	39,22	125	28,13	40	9,00	9,40
1	25,0	IRB0100	200	53,00	140	31,50	40	9,00	14,00

Size	Series/Size	Max. operating pressure						Burst pressure					
		Coupled		Male		Female		Coupled		Male		Female	
	Inch	MPa	psi	MPa	psi	MPa	psi	MPa	psi	MPa	psi	MPa	psi
1/8	IRB018	20	2900	20	2900	20	2900	100	14500	100	14500	100	14500
1/4	IRB014	20	2900	20	2900	20	2900	100	14500	100	14500	100	14500
3/8	IRB038	16	2320	16	2320	16	2320	80	11600	70	10150	80	11600
1/2	IRB012	16	2320	16	2320	16	2320	80	11600	70	10150	80	11600
3/4	IRB034	12,5	1813	12,5	1813	12,5	1813	60	8700	45	6525	60	8700
1	IRB0100	10	1450	10	1450	10	1450	40	5800	40	5800	40	5800

\*Spillage is an indicative value of the fluid loss during disconnection (according to ISO 7241-2 test method)

### Different possible configurations

**IRB version** construction material: carbon steel; seals: standard in NBR

**IRBX version** construction material: stainless steel (AISI 316L); seals: standard in Viton®

**IRB0 version** construction material: brass; seals: standard in Viton®

**Free flow version:** available upon request

### Temperature range:

IRB = standard seals in NBR (Nitrile): from -20 °C to +100 °C (from -4 °F to +212 °F)

IRBX, IRB0 = Seals in VITON®: from -15°C to +180°C ( from +5 °F to +356 °F). Please read carefully "instruction and warning" for proper selection of the products.

## ⚠ WARNING

A defect, a wrong choice or an improper use of products, can cause injury to persons, animals and objects. Connection under pressure are under residual pressure.

Never connect or disconnect with dynamic pressure (e.g. pump on).

Do not use the coupling disconnected with high impulse pressure.

Do not couple-uncouple with flow and/or pressure in the circuit.

Do not couple-uncouple when the temperature inside of the circuit is higher than 80 °C (176 °F).

Check the maximum allowable working pressure of the port in use.

Make sure that the medium used is compatible with seal and material as indicated for each series.

In case of doubt please contact Stucchi Technical Support.

The interchangeability is mentioned under the assumption that the manufacturer of the considered products has not changed any dimension.

**It is MANDATORY to read and closely follow the instructions. Last updated version always apply at time of installation, see latest written Instructions on Stucchi website ([www.stucchi.it](http://www.stucchi.it)) before selecting or using Stucchi products.**

## OVERALL DIMENSIONS

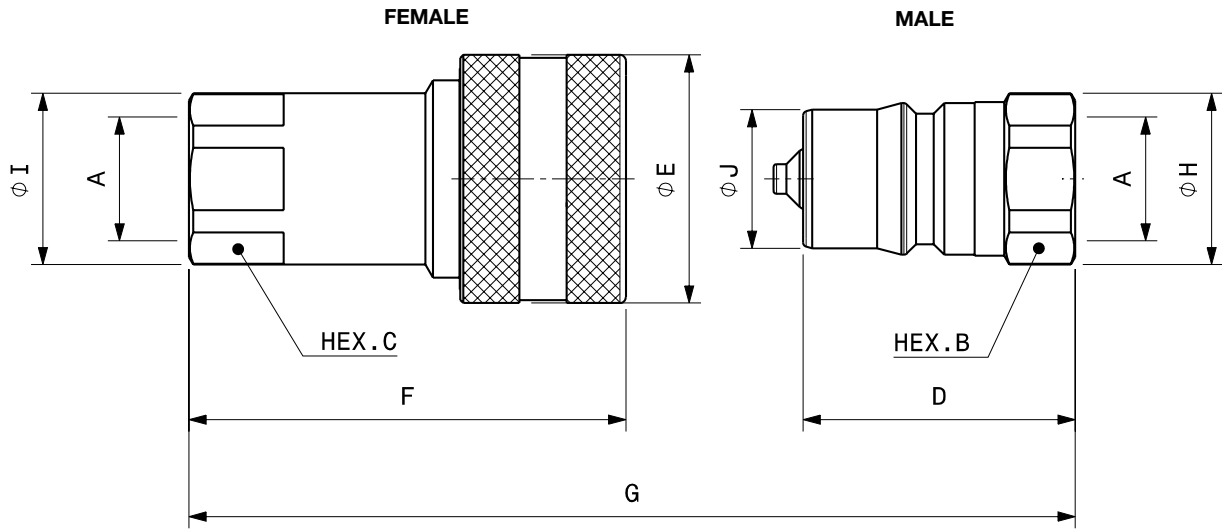

Port description: FEMALE THREAD BSPP (ISO 1179-1)

BODY SIZE	Descriptive Code	Item Code	ISO DN	PORT (A)	Overall Length		Length		Hex		Overall Diameter		Body Diameter		Weight						
					mm	inch	mm	inch	mm	inch	mm	inch	mm	inch	Kg	Lbs					
1/8"	F IRBO18 BSP	Female 804500100	5,0	1/8"	G	60,5	2,38	F	48,8	1,92	C	14,0	0,55	I	15,8	0,62	E	23,0	0,91	0,07	0,15
	M IRBO18 BSP	Male 804500101						D	30,0	1,18	B	14,0	0,55	H	15,8	0,62	J	10,8	0,43	0,02	0,04
1/4"	F IRBO14 BSP	Female 804500102	6,3	1/4"	G	70,7	2,78	F	57,0	2,24	C	19,0	0,75	I	21,2	0,83	E	27,0	1,06	0,13	0,29
	M IRBO14 BSP	Male 804500103						D	35,0	1,38	B	19,0	0,75	H	20,8	0,82	J	14,2	0,56	0,04	0,08
3/8"	F IRBO38 BSP	Female 804500104	10,0	3/8"	G	82,7	3,26	F	66,0	2,60	C	24,0	0,94	I	27,0	1,06	E	34,0	1,34	0,24	0,52
	M IRBO38 BSP	Male 804500105						D	41,0	1,61	B	24,0	0,94	H	26,0	1,02	J	19,1	0,75	0,07	0,16
1/2"	F IRBO12 BSP	Female 804500106	12,5	1/2"	G	92,6	3,65	F	73,9	2,91	C	27,0	1,06	I	29,0	1,14	E	42,0	1,65	0,34	0,76
	M IRBO12 BSP	Male 804500107						D	46,0	1,81	B	27,0	1,06	H	29,0	1,14	J	23,5	0,93	0,11	0,24
3/4"	F IRBO34 BSP	Female 804500108	20,0	3/4"	G	111,1	4,37	F	90,1	3,55	C	36,0	1,42	I	38,5	1,52	E	50,0	1,97	0,61	1,33
	M IRBO34 BSP	Male 804500109						D	55,0	2,17	B	36,0	1,42	H	38,5	1,52	J	31,4	1,24	0,22	0,48
1"	F IRBO100 BSP	Female 804500110	25,0	1"	G	133,2	5,24	F	106,2	4,18	C	41,0	1,61	I	44,8	1,76	E	60,0	2,36	0,93	2,04
	M IRBO100 BSP	Male 804500111						D	66,0	2,60	B	41,0	1,61	H	44,8	1,76	J	37,7	1,48	0,35	0,78

Port description: FEMALE THREAD NPT (ANSI B.1.20.1)

BODY SIZE	Descriptive Code	Item Code	ISO DN	PORT (A)	Overall Length		Length		Hex		Overall Diameter		Body Diameter		Weight						
					mm	inch	mm	inch	mm	inch	mm	inch	mm	inch	Kg	Lbs					
1/8"	F IRBO18 NPT	Female 804501100	5,0	1/8"	G	60,5	2,38	F	48,8	1,92	C	14,0	0,55	I	15,8	0,62	E	23,0	0,91	0,08	0,17
	M IRBO18 NPT	Male 804501101						D	30,0	1,18	B	14,0	0,55	H	15,8	0,62	J	10,8	0,43	0,02	0,04
1/4"	F IRBO14 NPT	Female 804501102	6,3	1/4"	G	70,7	2,78	F	57,0	2,24	C	19,0	0,75	I	21,2	0,83	E	27,0	1,06	0,13	0,29
	M IRBO14 NPT	Male 804501103						D	35,0	1,38	B	19,0	0,75	H	20,8	0,82	J	14,2	0,56	0,04	0,09
3/8"	F IRBO38 NPT	Female 804501104	10,0	3/8"	G	82,7	3,26	F	66,0	2,60	C	24,0	0,94	I	27,0	1,06	E	34,0	1,34	0,23	0,51
	M IRBO38 NPT	Male 804501105						D	41,0	1,61	B	24,0	0,94	H	26,0	1,02	J	19,1	0,75	0,08	0,17
1/2"	F IRBO12 NPT	Female 804501106	12,5	1/2"	G	92,6	3,65	F	73,9	2,91	C	27,0	1,06	I	29,0	1,14	E	42,0	1,65	0,35	0,76
	M IRBO12 NPT	Male 804501107						D	46,0	1,81	B	27,0	1,06	H	29,0	1,14	J	23,5	0,93	0,12	0,25
3/4"	F IRBO34 NPT	Female 804501108	20,0	3/4"	G	111,1	4,37	F	90,1	3,55	C	36,0	1,42	I	38,5	1,52	E	50,0	1,97	0,61	1,33
	M IRBO34 NPT	Male 804501109						D	55,0	2,17	B	36,0	1,42	H	38,5	1,52	J	31,4	1,24	0,22	0,49
1"	F IRBO100 NPT	Female 804501110	25,0	1"	G	133,2	5,24	F	106,2	4,18	C	41,0	1,61	I	44,8	1,76	E	60,0	2,36	0,94	2,07
	M IRBO100 NPT	Male 804501111						D	66,0	2,60	B	41,0	1,61	H	44,8	1,76	J	37,7	1,48	0,36	0,79



## SPARE KIT SEAL FOR FEMALE

Repair kit / OR+BK		
Body Size	Description	Part Number
1/8"	F IRB018 (OR+BK)	815700214
1/4"	F IRB014 (OR+BK)	815700216
3/8"	F IRB038 (OR+BK)	815700218
1/2"	F IRB012 (OR+BK)	815700220
3/4"	F IRB034 (OR+BK)	815700222
1"	F IRB0100 (OR+BK)	815700224

O-Ring in VITON®  
BackUp in Teflon®

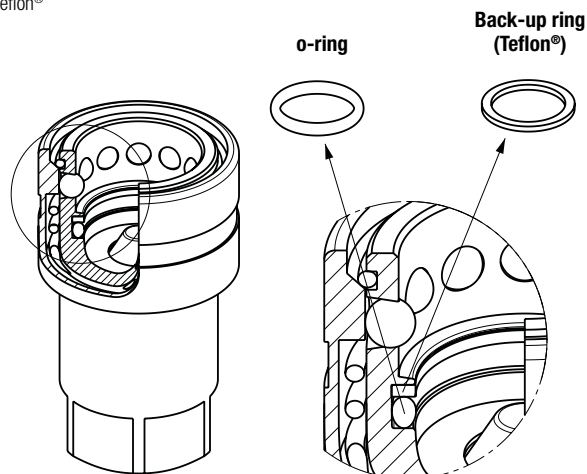

## PROTECTIVE CAPS FOR IRBO SERIES

Protective caps are always recommended to protect the couplings from damage, dirt inclusion, and will increase the product life. The protective caps for IRBO series are manufactured in PVC with connection lanyard (standard color red)

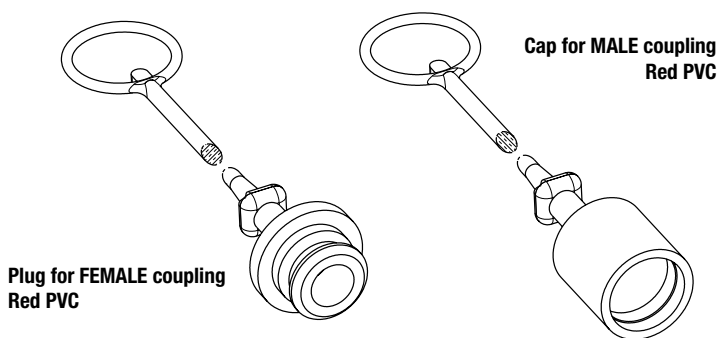

Body Size/Description		Protective Cap		Material/Color
		Plug for Female	Cap for Male	
1/4"	IRB014	815000032	815000033	PVC/Red
3/8"	IRB038	815000034	815000035	PVC/Red
1/2"	IRB012	815000036	815000037	PVC/Red
3/4"	IRB034	815000038	815000039	PVC/Red
1"	IRB0100	815000040	815000041	PVC/Red

## CENTRALA ELBLĄG

Ul. Rawska 19B  
82-300 Elbląg

tel. /+48/ 55 625 51 00

fax /+48/ 55 625 51 01

### Dział Handlowy

tel. /+48/ 55 625 51 51

elblag@hydropress.pl



[www.hydropress.pl](http://www.hydropress.pl)

### ODDZIAŁ GDAŃSK

tel. /+48/ 55 625 51 21

fax /+48/ 55 625 51 22

### ODDZIAŁ RUMIA

tel. /+48/ 58 679 34 15

fax /+48/ 55 625 51 25

### ODDZIAŁ TYCHY

tel. /+48/ 32 787 52 88

fax /+48/ 55 625 51 38

### ODDZIAŁ OLSZTYN

tel. /+48/ 89 532 01 05

fax /+48/ 89 715 21 42

### ODDZIAŁ WARSZAWA

tel. /+48/ 22 468 86 97

fax /+48/ 55 625 51 32

### BIURO WE WROCŁAWIU

tel. /+48/ 782 838 000

fax /+48/ 55 625 51 35

### BIURO W KIELCACH

tel. /+48/ 885 995 501

fax /+48/ 55 625 51 01

### BIURO W KRAKOWIE

tel. /+48/ 885 995 019

fax /+48/ 55 625 51 01

### BIURO W OPOLU

tel. /+48/ 885 995 011

fax /+48/ 55 625 51 01

### BIURO W BYDGOSZCZY

tel. /+48/ 790 222 771

fax /+48/ 55 625 51 01

### BIURO W BIAŁYMSTOKU

tel. /+48/ 89 532 01 05

fax /+48/ 89 715 21 42

### BIURO W ŁODZI

tel. /+48/ 609 221 421

fax /+48/ 89 715 21 42