



SZYBKOZŁĄCZA HYDRAULICZNE MULTIZŁĄCZA SERIA DP

DP2 2A-1EC

Previous description	Max. Resistance	FAP9 (A)	FAP13 (B)	FAP15 (C)	FAP17 (D)	FAP21 (E)	FAP30 (G)
Body size		3/8"	1/2"	5/8"	3/4"	1"	1-1/2"
DP2-9ZN	8000 N	2	A				



DRAWING



CONFIGURATIONS

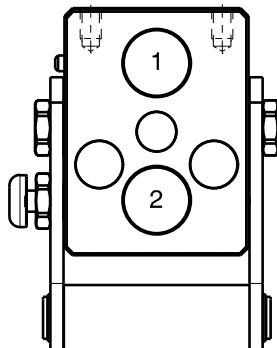

Possible configurations		
Pos	Coupling size	Predisposition for electrical connector
1	FAP9AZN	YES
2	FAP9AZN	-

MultiCoupling (couplings included)		
Code	Name	Description
870007016	MULTI COMPLETE DP2 2A	2 FAP9A 3/8 BSP - CAP
870007115	MULTI FIX DP2 2A	2 FAP9A 1/2 BSP
870007116	MULTI FIX DP2 2A	2 FAP9A 3/8 BSP
870007215	MULTI MOBILE DP2 2A	2 FAP9A 1/2 BSP
870007216	MULTI MOBILE DP2 2A	2 FAP9A 3/8 BSP

MultiCoupling spare parts (couplings not included)	
Code	Name
806000344	MULTI FIX EMPTY DP2 2A-1EC
806000345	MULTI MOBILE EMPTY DP2 2A-1EC
815606266	CAP FIX MULTICOUPLING DP 94x70
815606267	PARKING STATION MOBILE MULTICOUPLING DP 94x70
815701083	KIT NR.1 COMPLETE LEVER GROUP DP

Custom configurations available upon request

Fixed and mobile multicoupling

1,3 Kg and 0,6 Kg

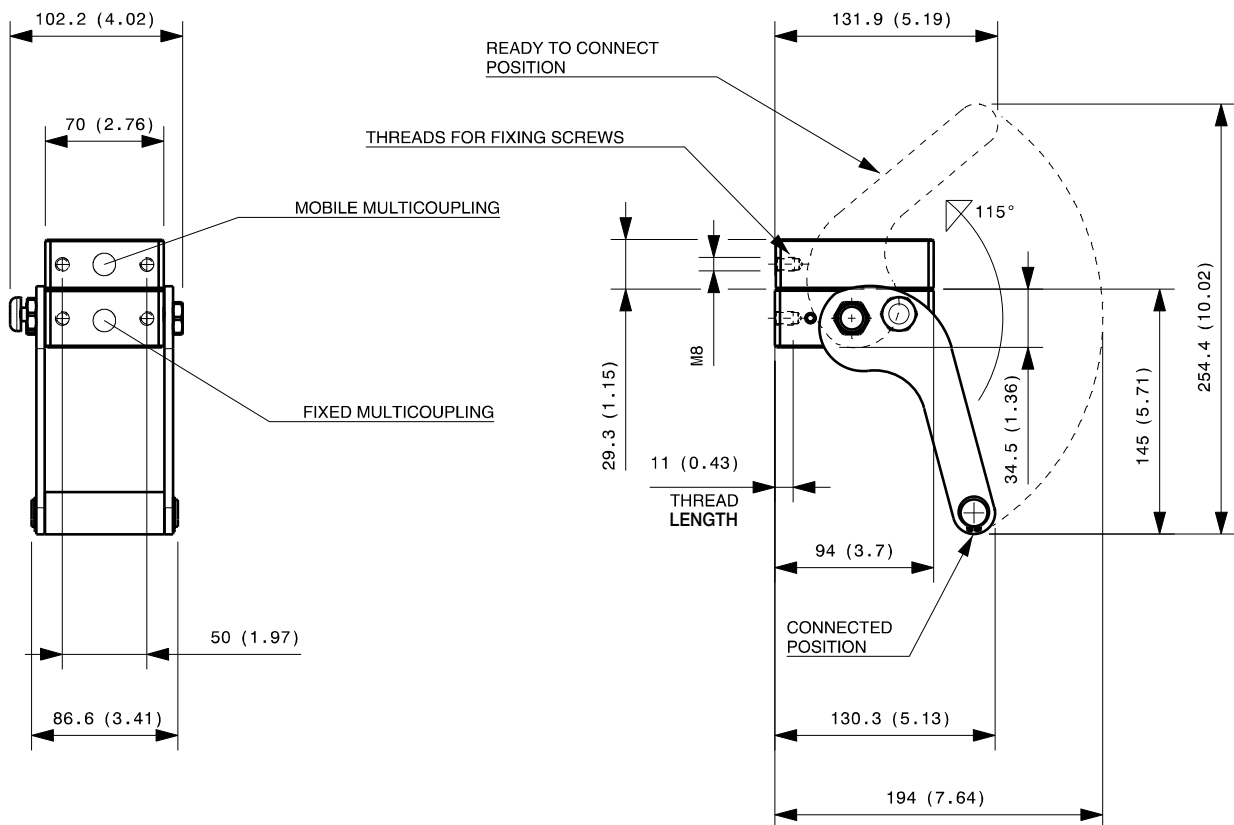

Dimensions in millimeters (inch)

Cap for fixed multicoupling 0,5 Kg

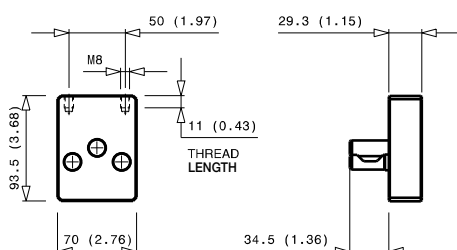

Parking station for mobile multicoupling 0,6 Kg

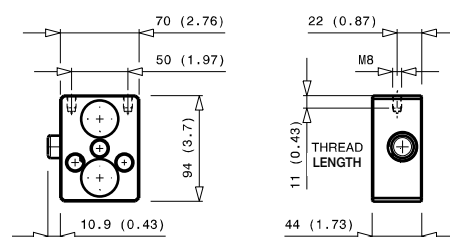

DP2 2A-2EC V04

Previous description	Max. Resistance	FAP9 (A)	FAP13 (B)	FAP15 (C)	FAP17 (D)	FAP21 (E)	FAP30 (G)
Body size		3/8"	1/2"	5/8"	3/4"	1"	1-1/2"
DP2-9L	8000 N	2	A				



DRAWING



CONFIGURATIONS

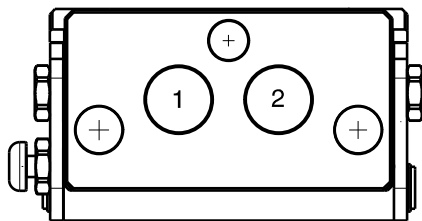

Possible configurations		
Pos	Coupling size	Predisposition for electrical connector
1	FAP9AZN	YES
2	FAP9AZN	YES

MultiCoupling (couplings included)		
Code	Name	Description
870008022	MULTI COMPLETE DP2 2A V04*	2 FAP9A 3/8 BSP - CAP
870008122	MULTI FIX DP2 2A V04*	2 FAP9A 3/8 BSP
870008222	MULTI MOBILE DP2 2A V04*	2 FAP9A 3/8 BSP

* V04 = it differs from DP2 2A standard because is longitudinal end has a different angle lever

MultiCoupling spare parts (couplings not included)	
Code	Name
806000410	MULTI FIX EMPTY DP2 2A-2EC V04*
806000411	MULTI MOBILE EMPTY DP2 2A-2EC V04*
815606310	CAP FIX MULTICOUPLING DP 125x69
815606311	PARKING STATION MOBILE MULTICOUPLING DP 125X69
815701215	KIT NR.1 COMPLETE LEVER GROUP DP
UPON REQUEST	SPECIFIC KIT FOR V04 MODEL

* V04 = it differs from DP2 2A standard because is longitudinal end has a different angle lever

Custom configurations available upon request

Fixed and mobile multicoupling

1,7 Kg and 0,7 Kg

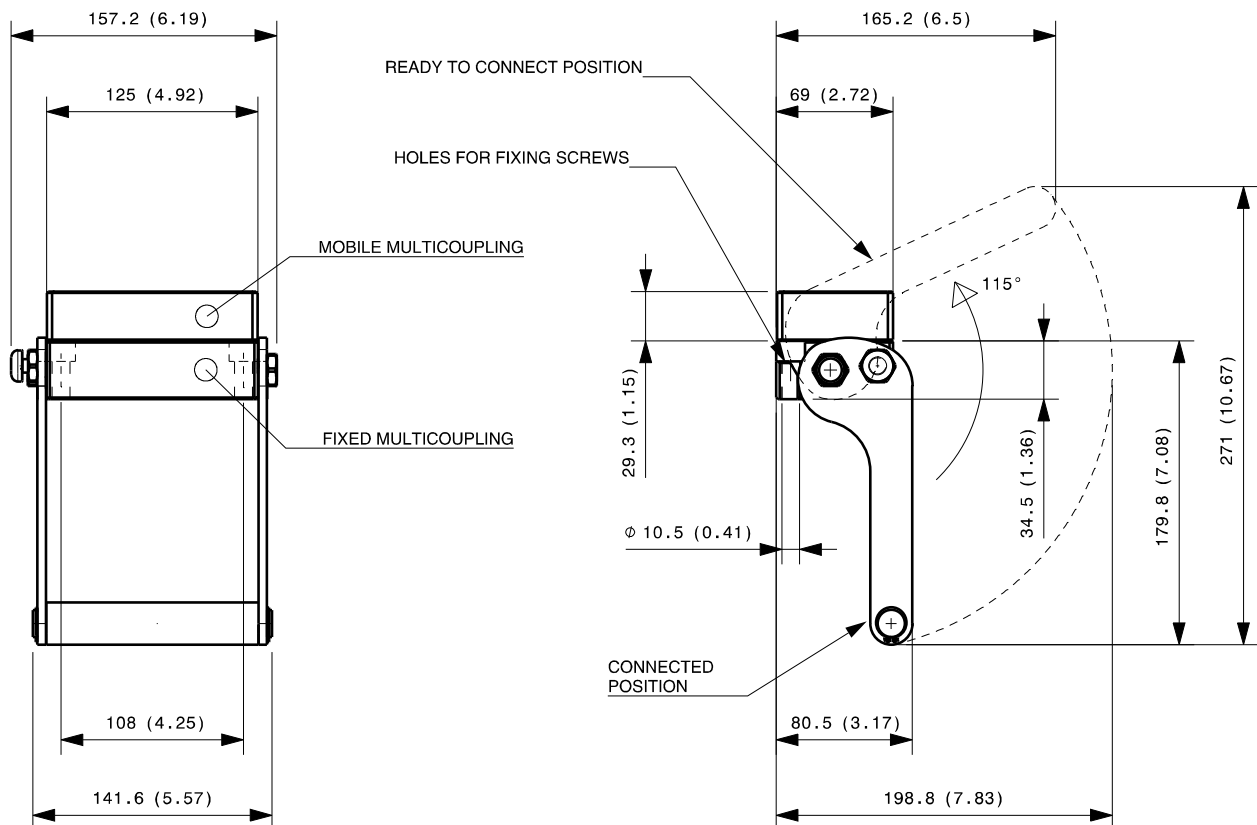

Dimensions in millimeters (inch)

Cap for fixed multicoupling 0,7 Kg

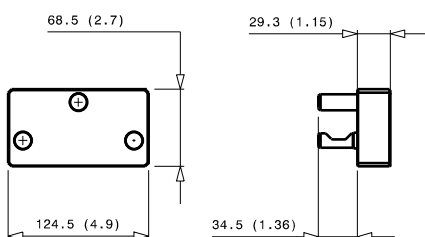

Parking station for mobile multicoupling 0,9 Kg

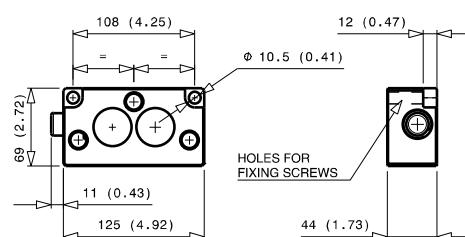

DP2 2B-1EC

Previous description	Max. Resistance Body size	FAP9 (A) 3/8"	FAP13 (B) 1/2"	FAP15 (C) 5/8"	FAP17 (D) 3/4"	FAP21 (E) 1"	FAP30 (G) 1-1/2"
DP2-13ZN	12000 N		2				



DRAWING



CONFIGURATIONS

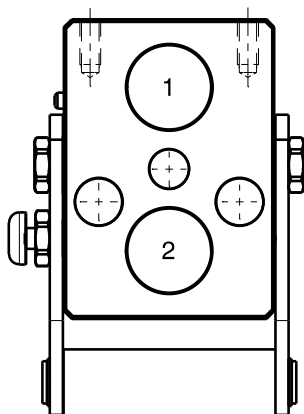

Possible configurations		
Pos	Coupling size	Predisposition for electrical connector
1	FAP13ZN	YES
2	FAP13ZN	-

MultiCoupling (couplings included)		
Code	Name	Description
870008016	MULTI COMPLETE DP2 2B	2 FAP13 3/4 BSP - CAP
870008019	MULTI COMPLETE DP2 2B	2 FAP13 1/2 BSP - CAP
870008119	MULTI FIX DP2 2B	2 FAP13 1/2 BSP
870008219	MULTI MOBILE DP2 2B	2 FAP13 1/2 BSP

MultiCoupling spare parts (couplings not included)	
Code	Name
806000346	MULTI FIX EMPTY DP2 2B-1EC
806000347	MULTI MOBILE EMPTY DP2 2B-1EC
815606270	CAP FIX MULTICOUPLING DP 114x80
815606271	PARKING STATION MOBILE MULTICOUPLING DP 114x80
815701082	KIT NR.1 COMPLETE LEVER GROUP DP

Custom configurations available upon request

Fixed and mobile multicoupling

1,6 Kg and 0,8 Kg

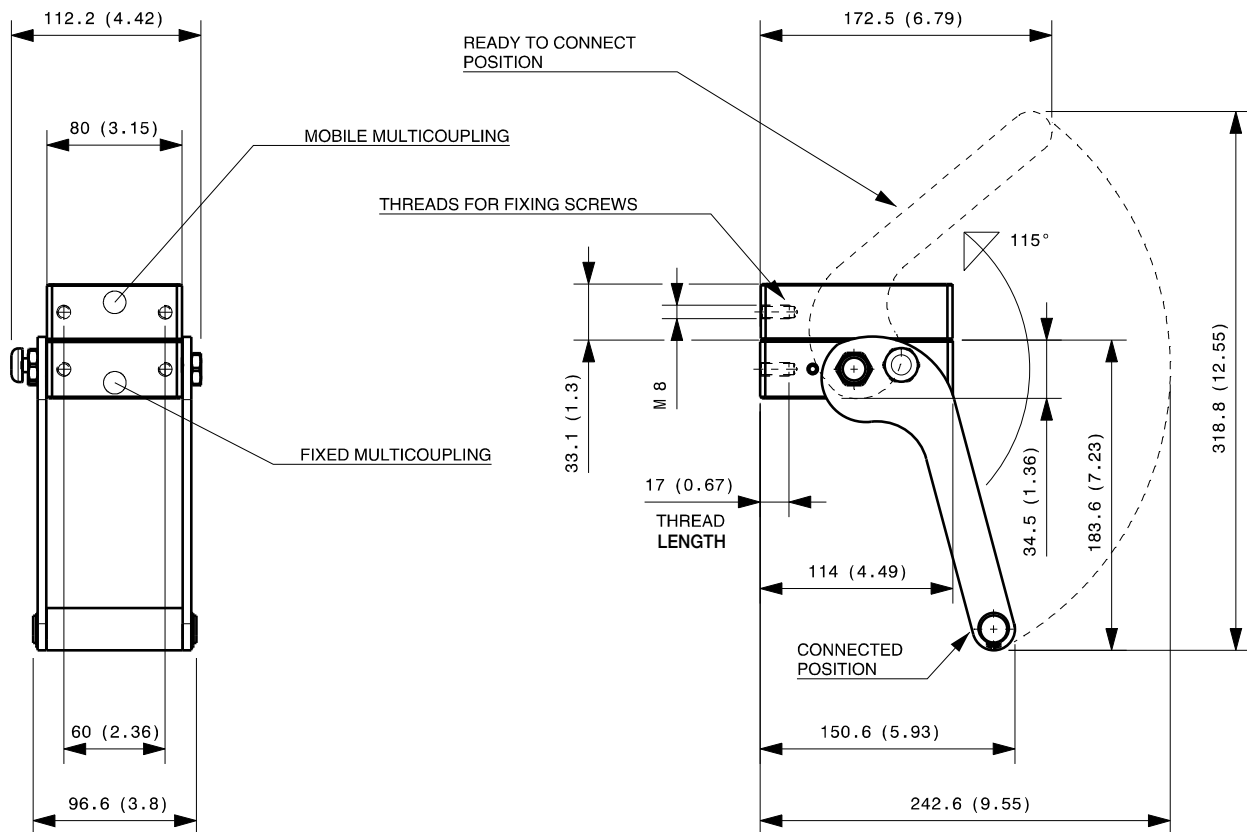

Dimensions in millimeters (inch)

Cap for fixed multicoupling 0,8 Kg

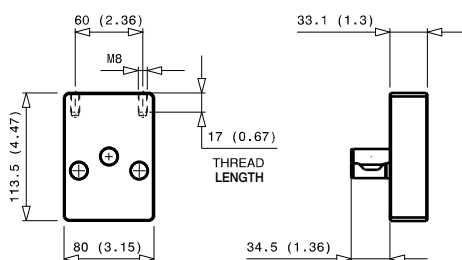

Parking station for mobile multicoupling 0,8 Kg

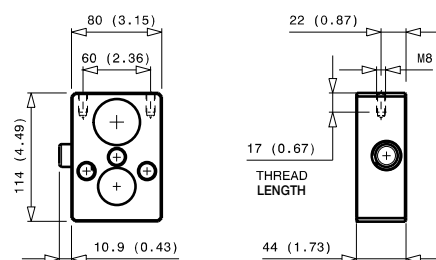

DP2 2B-2EC V04

Previous description	Max. Resistance	FAP9 (A)	FAP13 (B)	FAP15 (C)	FAP17 (D)	FAP21 (E)	FAP30 (G)
Body size		3/8"	1/2"	5/8"	3/4"	1"	1-1/2"
DP2-13L	12000 N		2				



DRAWING



CONFIGURATIONS

Possible configurations		
Pos	Coupling size	Predisposition for electrical connector
1	FAP13ZN	YES
2	FAP13ZN	YES

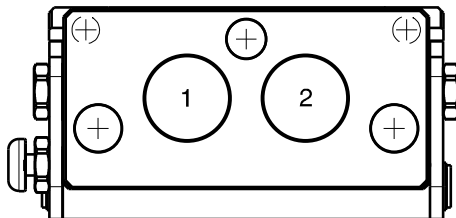

MultiCoupling (couplings included)		
Code	Name	Description
870008012	MULTI COMPLETE DP2 2B V04*	2 FAP13 1/2 BSP - CAP
870008112	MULTI FIX DP2 2B V04*	2 FAP13 1/2 BSP
870008212	MULTI MOBILE DP2 2B V04*	2 FAP13 1/2 BSP
870008221	MULTI MOBILE DP2 2B V04*	2 FAP13 3/4 BSP

* V04 = it differs from DP2 2B standard because is longitudinal end has a different angle lever

MultiCoupling spare parts (couplings not included)	
Code	Name
806000368	MULTI FIX EMPTY DP2 2B-2EC V04*
806000369	MULTI MOBILE EMPTY DP2 2B-2EC V04*
815606240	CAP FIX MULTICOUPLING DP 139x69
815606309	PARKING STATION MOBILE MULTICOUPLING DP 139x69
815701088	KIT NR.1 COMPLETE LEVER GROUP DP
UPON REQUEST	SPECIFIC KIT FOR V04 MODEL

* V04 = it differs from DP2 2B standard because is longitudinal end has a different angle lever

Custom configurations available upon request

Fixed and mobile multicoupling

1,8 Kg and 0,8 Kg

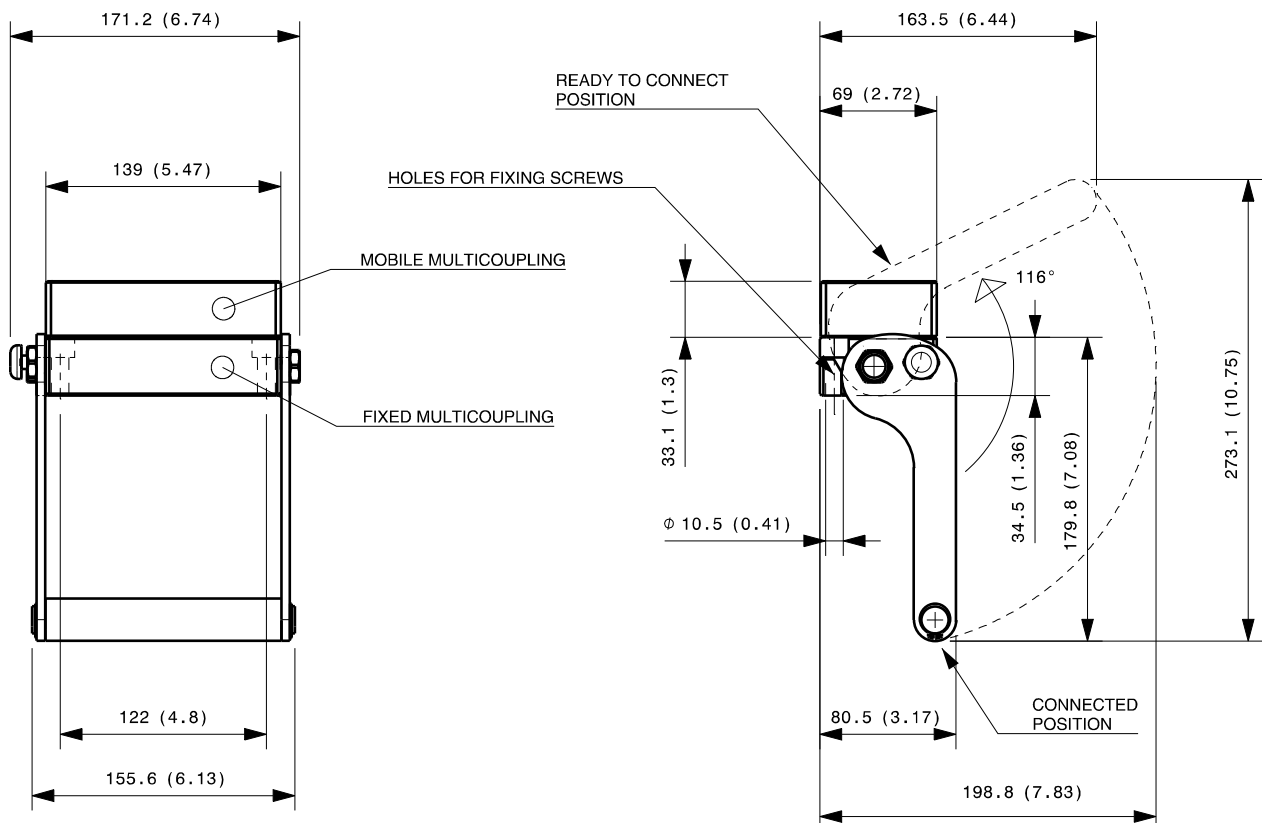

Dimensions in millimeters (inch)

Cap for fixed multicoupling 0,8 Kg

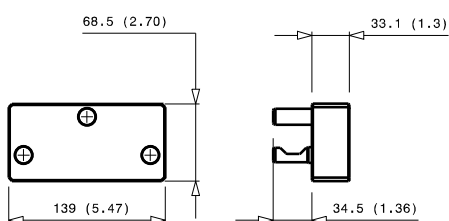

Parking station for mobile multicoupling 0,8 Kg

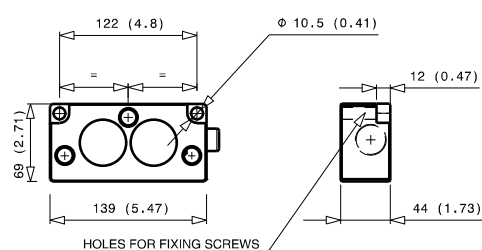

DP2 2C

Previous description	Max. Resistance Body size	FAP9 (A) 3/8"	FAP13 (B) 1/2"	FAP15 (C) 5/8"	FAP17 (D) 3/4"	FAP21 (E) 1"	FAP30 (G) 1-1/2"
DP2-15	15500 N			2			



DRAWING



CONFIGURATIONS

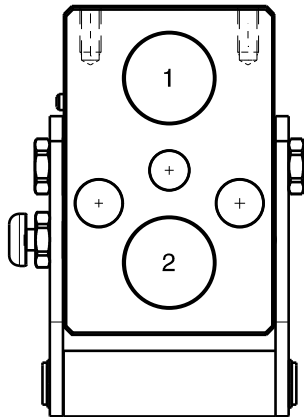

Possible configurations		
Pos	Coupling size	Predisposition for electrical connector
1	FAP15ZN	-
2	FAP15ZN	-

MultiCoupling (couplings included)		
Code	Name	Description
870008018	MULTI COMPLETE DP2 2C	2 FAP15 3/4 BSP - CAP
870008118	MULTI FIX DP2 2C	2 FAP15 3/4 BSP
870008218	MULTI MOBILE DP2 2C	2 FAP15 3/4 BSP

MultiCoupling spare parts (couplings not included)	
Code	Name
806000308	MULTI FIX EMPTY DP2 2C
806000309	MULTI MOBILE EMPTY DP2 2C
815606238	CAP FIX MULTICOUPLING DP 125x80
815606239	PARKING STATION MOBILE MULTICOUPLING DP 125x80
815701082	KIT NR.1 COMPLETE LEVER GROUP DP

Custom configurations available upon request

Fixed and mobile multicoupling

1,6 Kg and 0,8 Kg

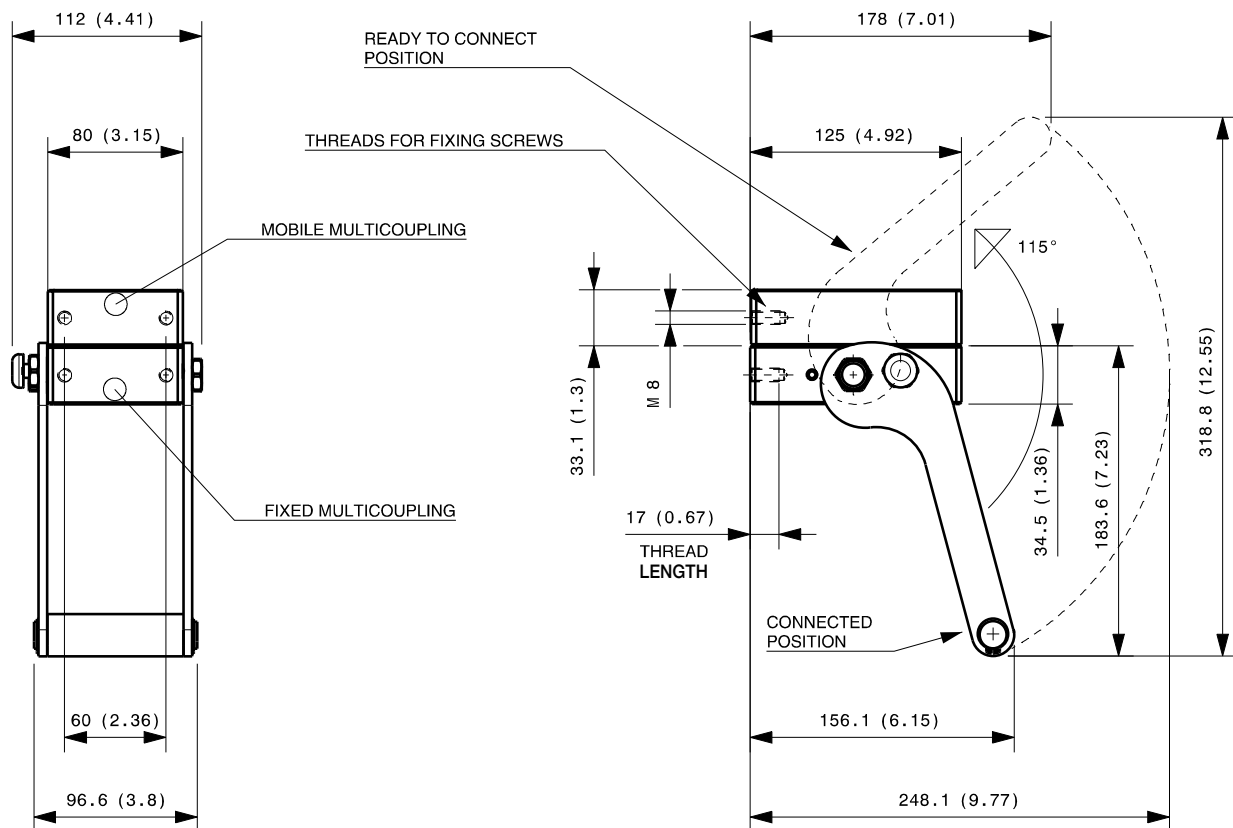

Dimensions in millimeters (inch)

Cap for fixed multicoupling 0,8 Kg

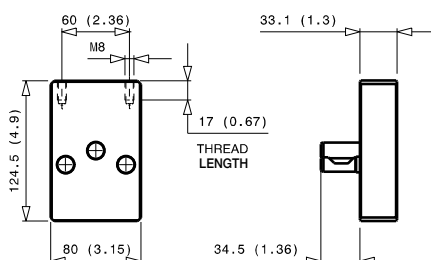

Parking station for mobile multicoupling 0,8 Kg

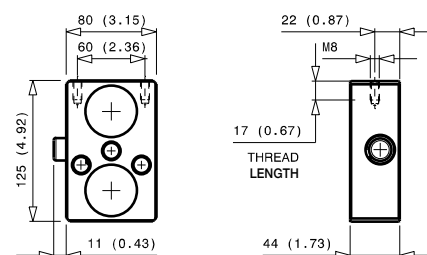

DP2 2D

Previous description	Max. Resistance Body size	FAP9 (A) 3/8"	FAP13 (B) 1/2"	FAP15 (C) 5/8"	FAP17 (D) 3/4"	FAP21 (E) 1"	FAP30 (G) 1-1/2"
DP2-17ZN	18000 N				2		



DRAWING

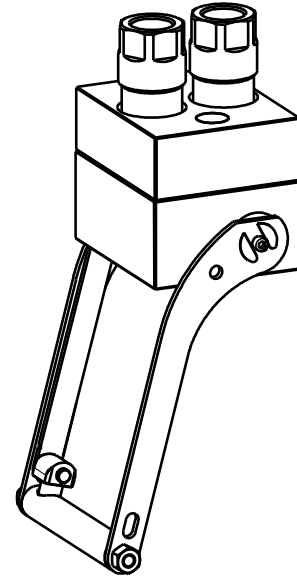

CONFIGURATIONS

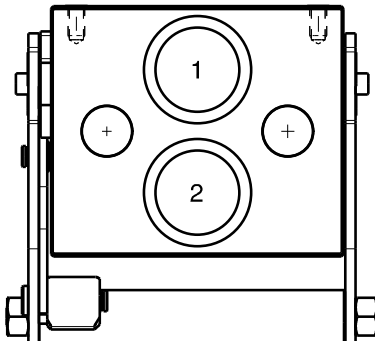

Possible configurations		
Pos	Coupling size	Predisposition for electrical connector
1	FAP17ZN	-
2	FAP17ZN	-

MultiCoupling (couplings included)		
Code	Name	Description
870008017	MULTI COMPLETE DP2 2D	2 FAP17 1' BSP - CAP
870008113	MULTI FIX DP2 2D	2 FAP17 1' NPT
870008117	MULTI FIX DP2 2D	2 FAP17 1' BSP
870008213	MULTI MOBILE DP2 2D	2 FAP17 1' NPT
870008217	MULTI MOBILE DP2 2D	2 FAP17 1' BSP

MultiCoupling spare parts (couplings not included)	
Code	Name
806000348	MULTI FIX EMPTY DP2 2D
806000349	MULTI MOBILE EMPTY DP2 2D
815606272	CAP FIX MULTICOUPLING DP 139x118
815606273	PARKING STATION MOBILE MULTICOUPLING DP 139x120
815701084	KIT NR.1 COMPLETE LEVER GROUP DP

Custom configurations available upon request

Fixed and mobile multicoupling

3,9 Kg and 2,1 Kg

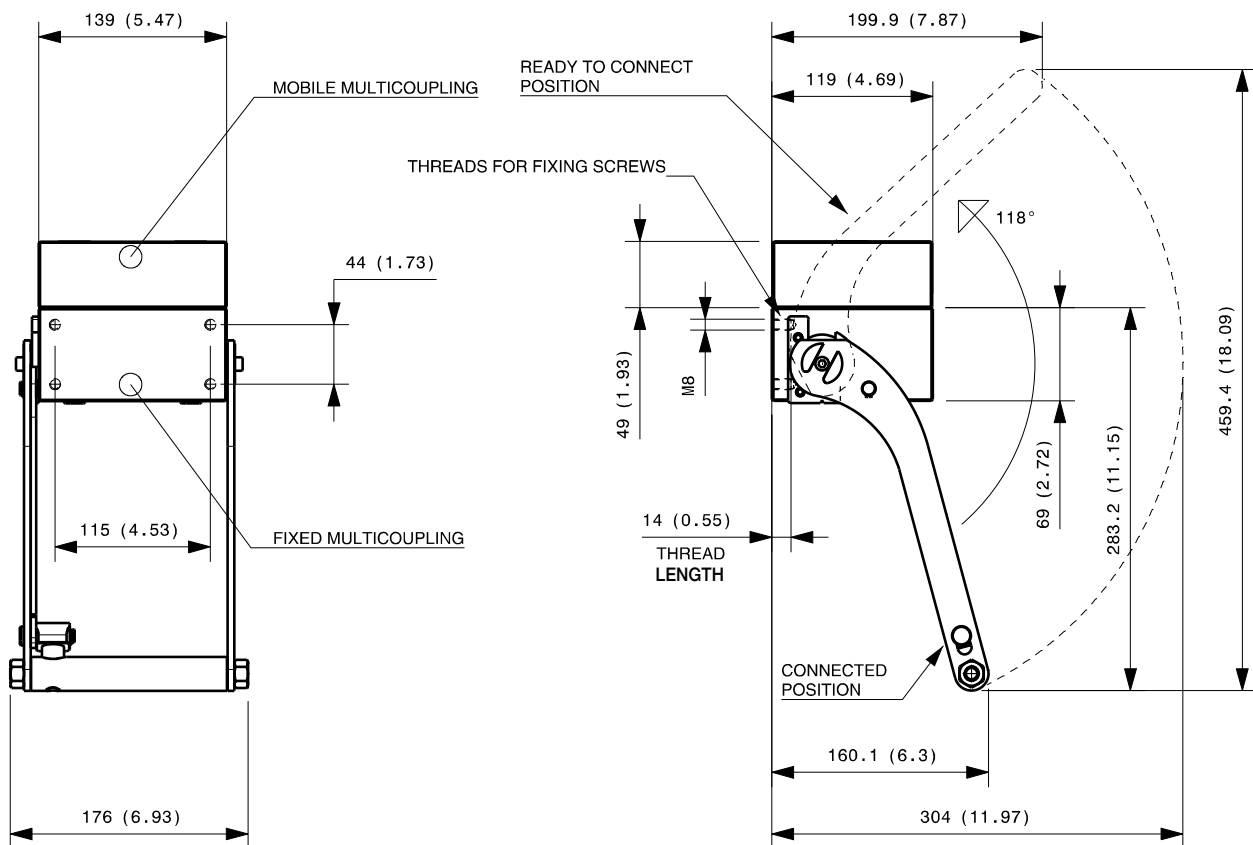

Dimensions in millimeters (inch)

Cap for fixed multicoupling 2,3 Kg

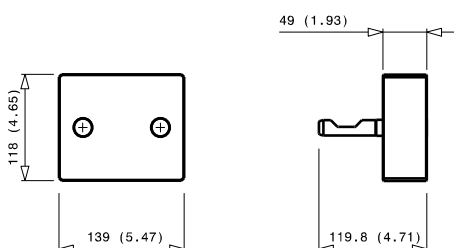

Parking station for mobile multicoupling 1,8 Kg

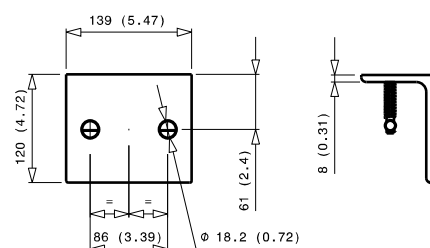

DP2 1A-1B

Previous description	Max. Resistance	FAP9 (A)	FAP13 (B)	FAP15 (C)	FAP17 (D)	FAP21 (E)	FAP30 (G)
Body size		3/8"	1/2"	5/8"	3/4"	1"	1-1/2"
DPT2ZN	10000 N	1 D	1				



DRAWING



CONFIGURATIONS

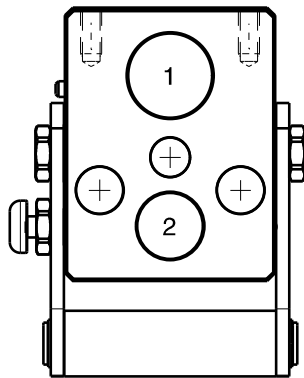

Possible configurations		
Pos	Coupling size	Predisposition for electrical connector
1	FAP13ZN	-
2	FAP9DZN	-

MultiCoupling (couplings included)		
Code	Name	Description
870009014	MULTI COMPLETE DP2 1A-1B	1 FAP9D 3/8 BSP - 1 FAP13 1/2 BSP - CAP
870009114	MULTI FIX DP2 1A-1B	1 FAP9D 3/8 BSP - 1 FAP13 1/2 BSP
870009214	MULTI MOBILE DP2 1A-1B	1 FAP9D 3/8 BSP - 1 FAP13 1/2 BSP

MultiCoupling spare parts (couplings not included)	
Code	Name
806000354	MULTI FIX EMPTY DP2 1A-1B
806000355	MULTI MOBILE EMPTY DP2 1A-1B
815606268	CAP FIX MULTICOUPLING DP 104x80
815606269	PARKING STATION MOBILE MULTICOUPLING DP 104x80
815701086	KIT NR.1 COMPLETE LEVER GROUP DP

Custom configurations available upon request

Fixed and mobile multicoupling

1,5 Kg and 0,8 Kg

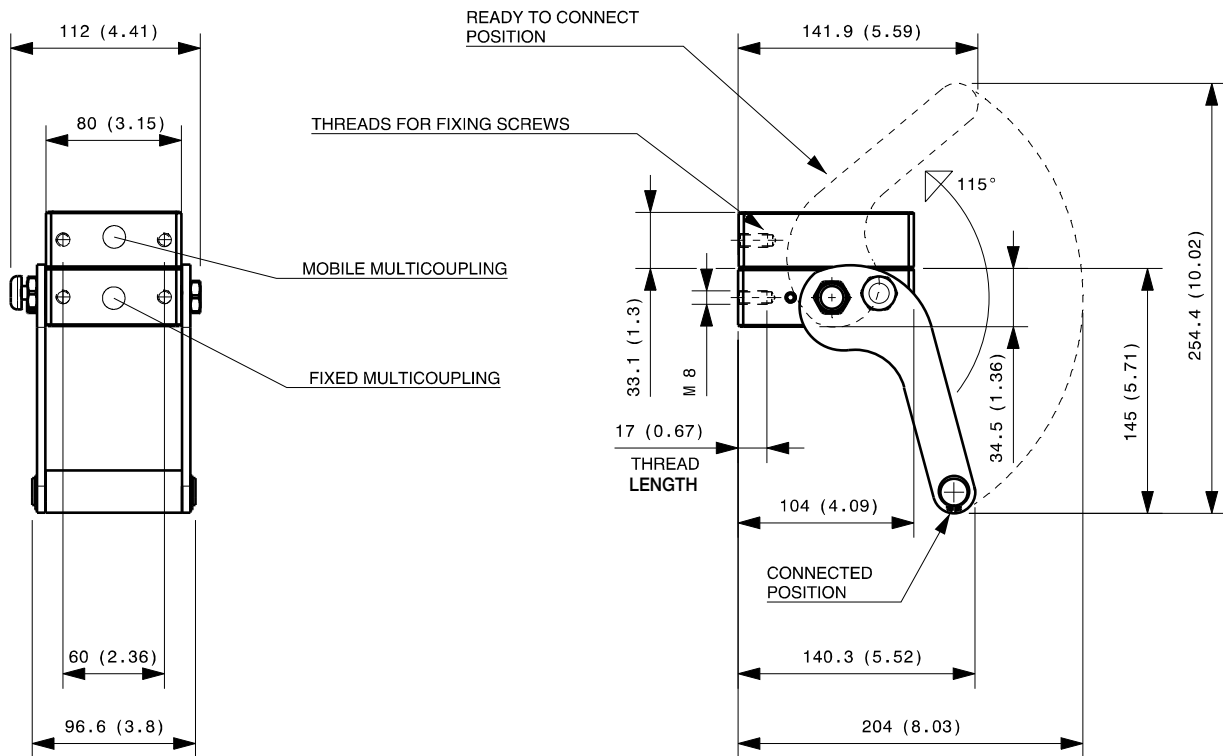

Dimensions in millimeters (inch)

Cap for fixed multicoupling 0,8 Kg

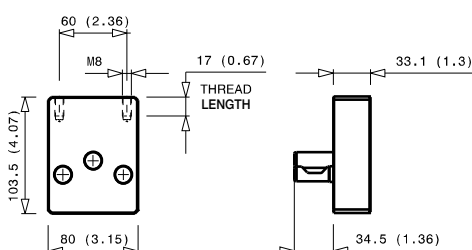

Parking station for mobile multicoupling 0,8 Kg

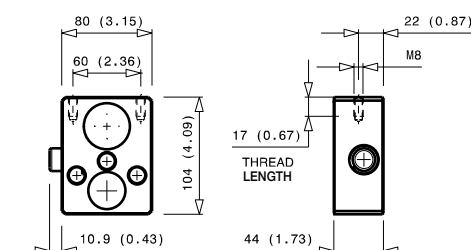

DP3 1A-1B-1EC

Previous description	Max. Resistance	FAP9 (A)	FAP13 (B)	FAP15 (C)	FAP17 (D)	FAP21 (E)	FAP30 (G)
Body size		3/8"	1/2"	5/8"	3/4"	1"	1-1/2"
DPT3ZN	10000 N	1 D	1				



DRAWING



CONFIGURATIONS

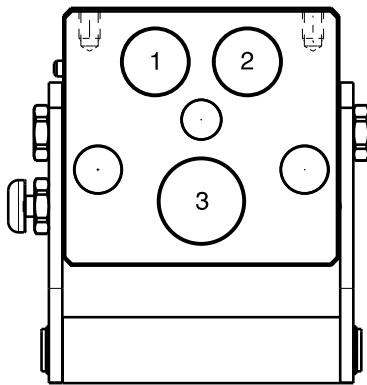

Possible configurations		
Pos	Coupling size	Predisposition for electrical connector
1	FAP9DZN	-
2	-	YES
3	FAP13ZN	-

MultiCoupling (couplings included)		
Code	Name	Description
870009015	MULTI COMPLETE DP3 1A-1B-1EC	1 FAP9D 3/8 BSP - 1 FAP13ZN 1/2 BSP - 1EC7 - CAP
870009115	MULTI FIX DP3 1A-1B-1EC	1 FAP9D 3/8 BSP - 1 FAP13ZN 1/2 BSP - 1EC7
870009215	MULTI MOBILE DP3 1A-1B-1EC	1 FAP9D 3/8 BSP - 1 FAP13ZN 1/2 BSP - 1EC7

MultiCoupling spare parts (couplings not included)		
Code	Name	
806000356	MULTI FIX EMPTY DP3 1A-1B-1EC	
806000357	MULTI MOBILE EMPTY DP3 1A-1B-1EC	
815606276	CAP FIX MULTICOUPLING DP 105x98	
815701081	KIT NR.1 COMPLETE LEVER GROUP DP	

Custom configurations available upon request

Fixed and mobile multicoupling

1,5 Kg and 0,8 Kg

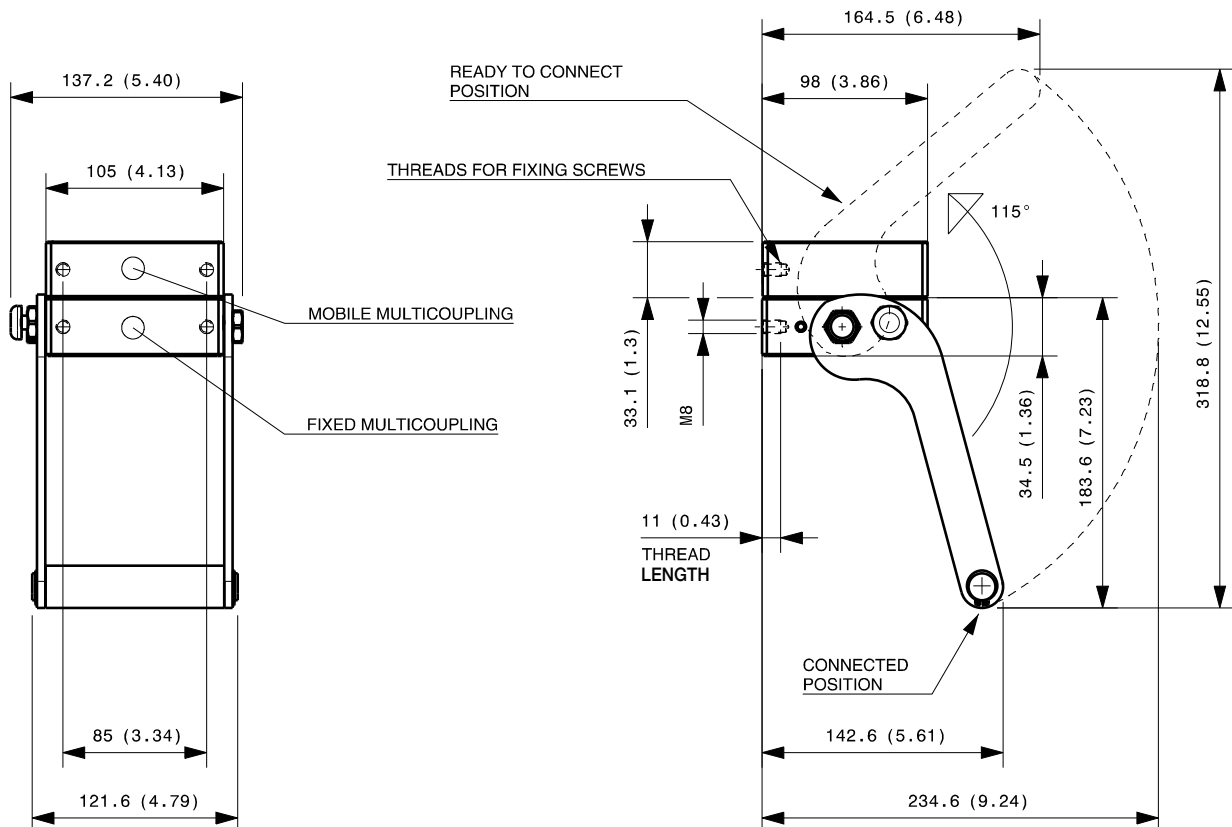

Dimensions in millimeters (inch)

Cap for fixed multicoupling 0,8 Kg

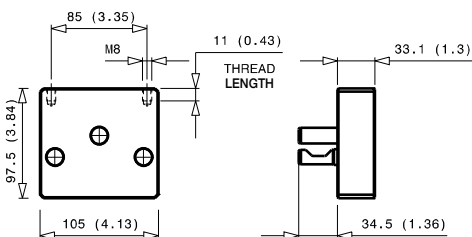

DP3 1C-2E

Previous description	Max. Resistance	FAP9 (A)	FAP13 (B)	FAP15 (C)	FAP17 (D)	FAP21 (E)	FAP30 (G)
DP3GE	23000 N	3/8"	1/2"	5/8"	3/4"	1"	1-1/2"
				1		2	



DRAWING

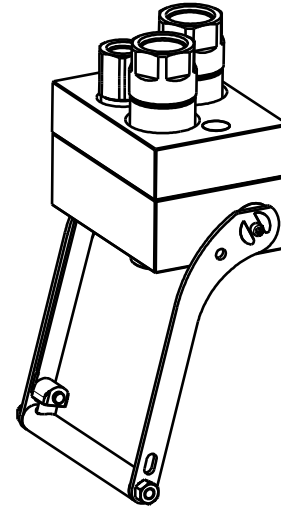

CONFIGURATIONS

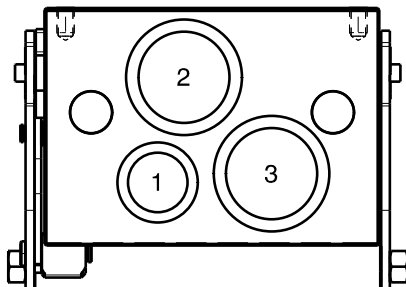

Possible configurations		
Pos	Coupling size	Predisposition for electrical connector
1	FAP15ZN	-
2	FAP21ZN	-
3	FAP21ZN	-

MultiCoupling (couplings included)		
Code	Name	Description
870015088	MULTI COMPLETE DP3 1C-2E	1 FAP15 3/4 SAE - 2 FAP21 1-1/4 SAE - CAP
870015188	MULTI FIX DP3 1C-2E	1 FAP15 3/4 SAE - 2 FAP21 1-1/4 SAE
870015288	MULTI MOBILE DP3 1C-2E	1 FAP15 3/4 SAE - 2 FAP21 1-1/4 SAE

MultiCoupling spare parts (couplings not included)		
Code	Name	Description
806000392	MULTI FIX EMPTY DP3 1C-2E	
806000393	MULTI MOBILE EMPTY DP3 1C-2E	
815606300	CAP FIX MULTICOUPLING DP 191x135	
815606301	PARKING STATION MOBILE MULTICOUPLING DP 190x140	
815701089	KIT NR.1 COMPLETE LEVER GROUP DP	

Custom configurations available upon request

Fixed and mobile multicoupling

5,3 Kg and 2,8 Kg

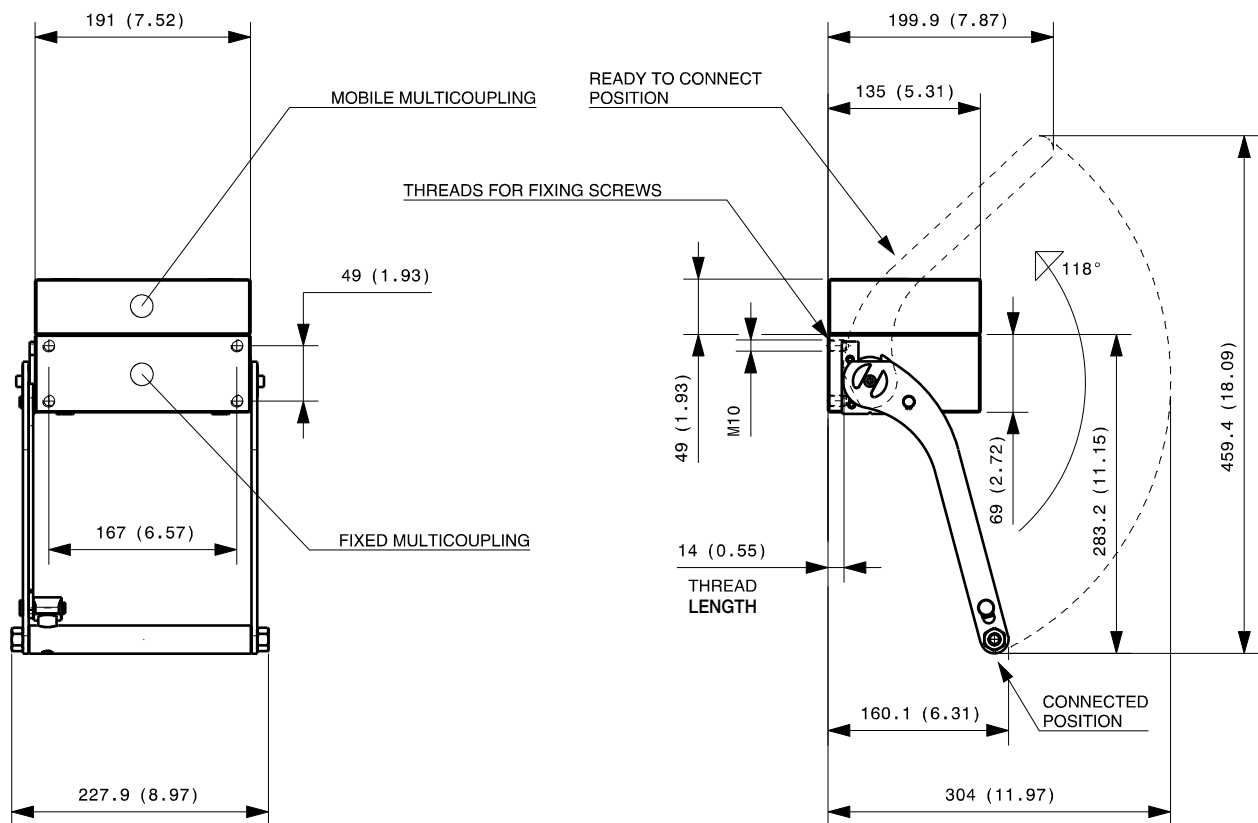

Dimensions in millimeters (inch)

Cap for fixed multicoupling 3,3 Kg

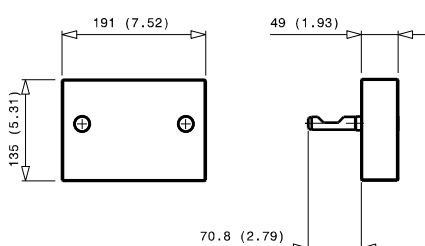

Parking station for mobile multicoupling 3,3 Kg

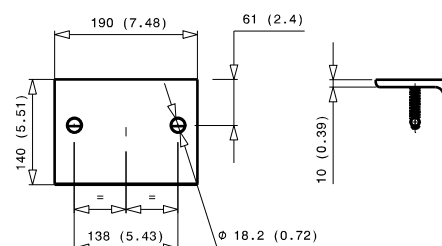

DP3 2A-1EC

Previous description	Max. Resistance	FAP9 (A)	FAP13 (B)	FAP15 (C)	FAP17 (D)	FAP21 (E)	FAP30 (G)
Body size		3/8"	1/2"	5/8"	3/4"	1"	1-1/2"
DPJ3ZN	8000 N	2	A				



DRAWING



CONFIGURATIONS

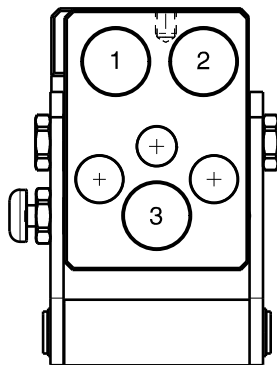

Possible configurations		
Pos	Coupling size	Predisposition for electrical connector
1	FAP9AZN	-
2	-	YES
3	FAP9AZN	-

MultiCoupling (couplings included)		
Code	Name	Description
870009016	MULTI COMPLETE DP3 2A-1EC	2 FAP9A 3/8 BSP - 1EC6 - CAP
870009116	MULTI FIX DP3 2A-1EC	2 FAP9A 3/8 BSP - 1EC6
870009216	MULTI MOBILE DP3 2A-1EC	2 FAP9A 3/8 BSP - 1EC6

MultiCoupling spare parts (couplings not included)	
Code	Name
806000358	MULTI FIX EMPTY DP3 2A-1EC
806000359	MULTI MOBILE EMPTY DP3 2A-1EC
815606274	CAP FIX MULTICOUPLING DP 99x70
815606275	PARKING STATION MOBILE MULTICOUPLING DP 100x70
815701083	KIT NR.1 COMPLETE LEVER GROUP DP

Custom configurations available upon request

Fixed and mobile multicoupling

1,3 Kg and 0,6 Kg

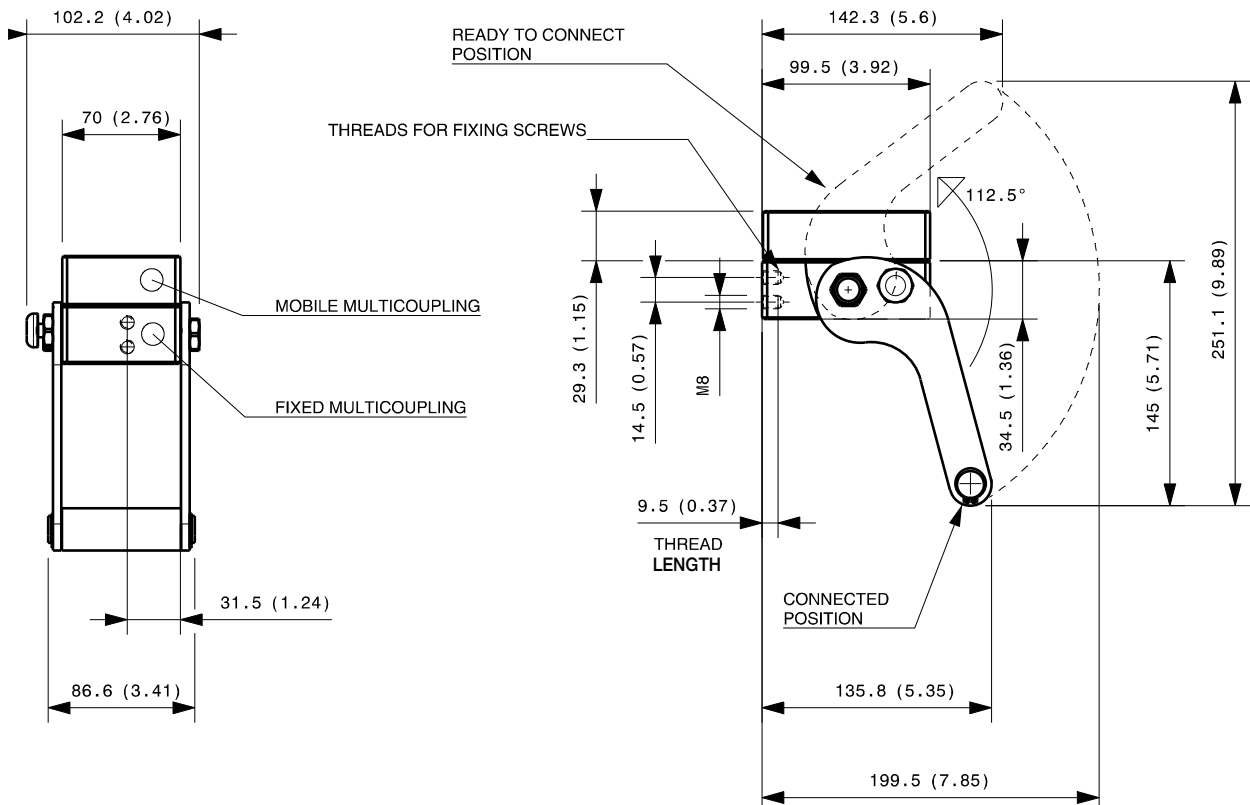

Dimensions in millimeters (inch)

Cap for fixed multicoupling 0,5 Kg

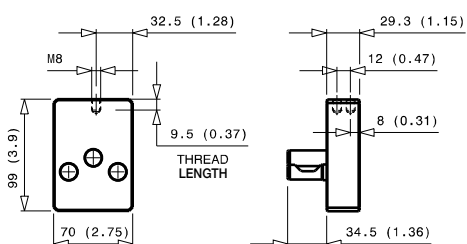

Parking station for mobile multicoupling 0,6 Kg

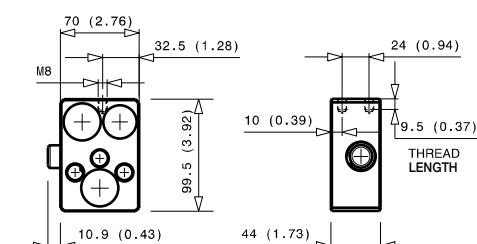

DP4 4A-2EC

Previous description	Max. Resistance Body size	FAP9 (A) 3/8"	FAP13 (B) 1/2"	FAP15 (C) 5/8"	FAP17 (D) 3/4"	FAP21 (E) 1"	FAP30 (G) 1-1/2"
DP4-9ZN	17000 N	2	A				



DRAWING

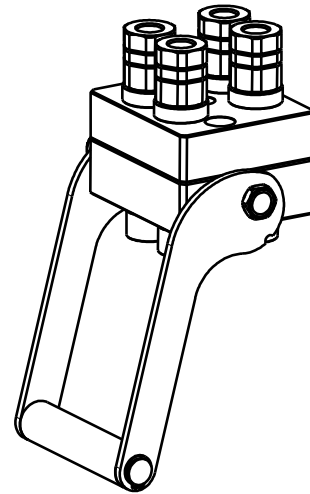

CONFIGURATIONS

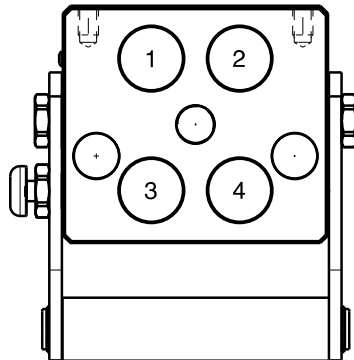

Possible configurations		
Pos	Coupling size	Predisposition for electrical connector
1	FAP9AZN	-
2	FAP9AZN	YES
3	FAP9AZN	YES
4	FAP9AZN	-

MultiCoupling (couplings included)		
Code	Name	Description
870011017	MULTI COMPLETE DP4 4A	4 FAP9A 3/8 BSP - CAP
870011020	MULTI COMPLETE DP4 4A	4 FAP9A 1/2 BSP - CAP
870011022	MULTI COMPLETE DP4 4A	4 FAP9A 1/4 BSP - CAP
870011027	MULTI COMPLETE DP4 4A	4 FAQ9A 3/8 BSP - CAP
870011028	MULTI COMPLETE DP4 4A	4 FAP9A 3/8 SAE - CAP
870011124	MULTI COMPLETE DP4 4A V02*	2 FAP9A 3/8 BSP - 2 FAP9A 1/2 BSP - CAP
870011117	MULTI FIX DP4 4A	4 FAP9A 3/8 BSP
870011120	MULTI FIX DP4 4A	4 FAP9A 1/2 BSP
870011122	MULTI FIX DP4 4A	4 FAP9A 1/4 BSP
870011123	MULTI FIX DP4 4A	2 FAP9A 3/8 BSP - 2 FAP9A 1/2 BSP
870011125	MULTI FIX DP4 2A	2 FAP9A 3/8 BSP
870011126	MULTI FIX DP4 4A	4 FAP9A 1/2 SAE
870011217	MULTI MOBILE DP4 4A	4 FAP9A 3/8 BSP
870011220	MULTI MOBILE DP4 4A	4 FAP9A 1/2 BSP
870011222	MULTI MOBILE DP4 4A	4 FAP9A 1/4 BSP
870011223	MULTI MOBILE DP4 4A	2 FAP9A 3/8 BSP - 2 FAP9A 1/2 BSP

* V02 = side button

MultiCoupling spare parts (couplings not included)		
Code	Name	
806000264	MULTI FIX EMPTY DP4 4A-2EC	
806000370	MULTI FIX EMPTY DP4 4A V02*	
806000265	MULTI MOBILE EMPTY DP4 4A-2EC	
815606280	CAP FIX MULTICOUPLING DP 105x94	
815606281	PARKING STATION MOBILE MULTICOUPLING DP 105x94	
815701081	KIT NR.1 COMPLETE LEVER GROUP DP	
UPON REQUEST	SPECIFIC KIT FOR V02 MODEL	

* V02 = side button

Custom configurations
available upon request

Fixed and mobile multicoupling

1,7 Kg and 0,7 Kg

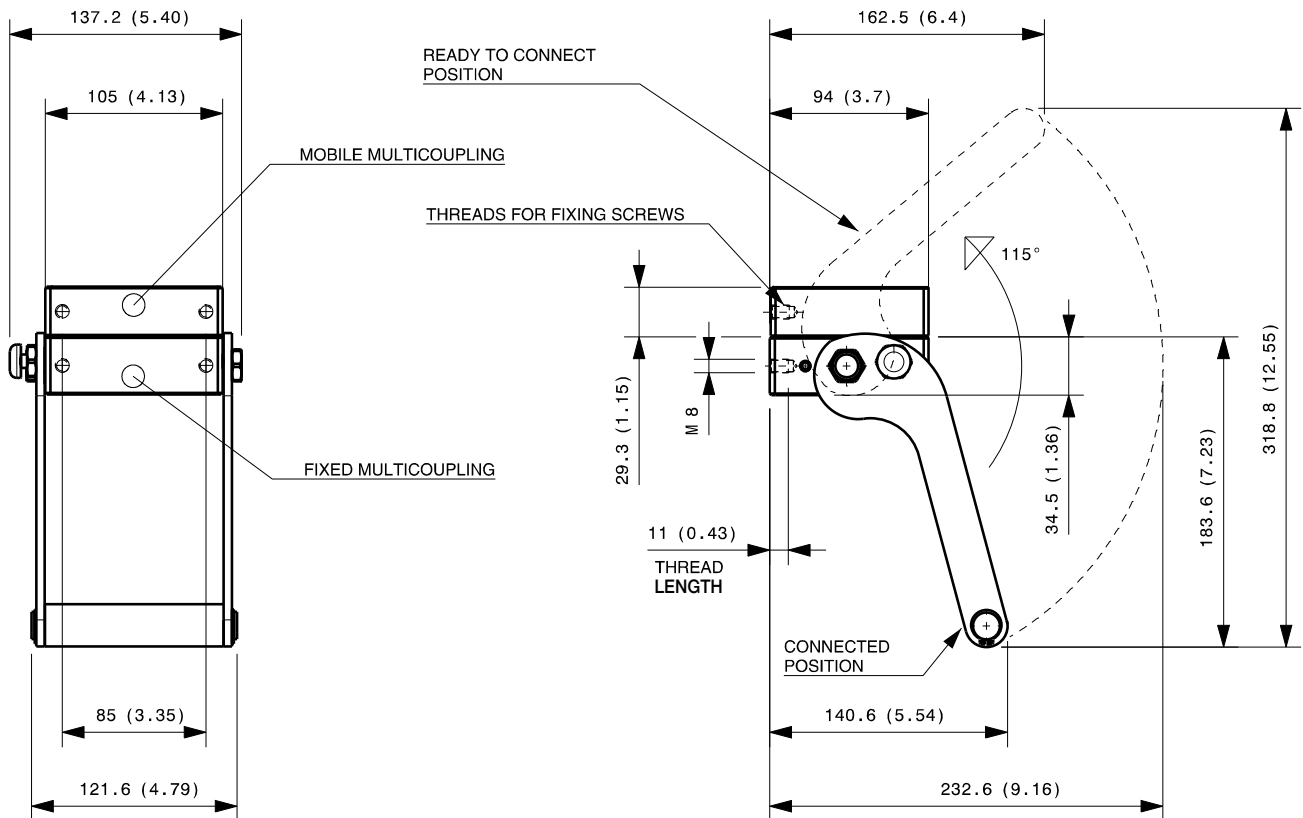

Available also model with button in other side,
in case of need ask the drawing to info@stucchi.it

Dimensions in millimeters (inch)

Cap for fixed multicoupling 0,7 Kg

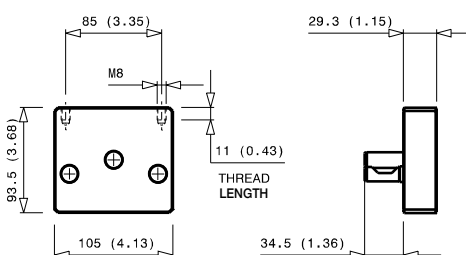

Parking station for mobile multicoupling 0,9 Kg

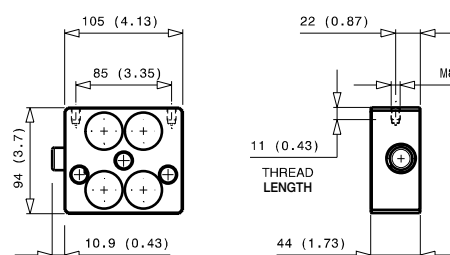

DP4 4B-2EC

Previous description	Max. Resistance Body size	FAP9 (A) 3/8"	FAP13 (B) 1/2"	FAP15 (C) 5/8"	FAP17 (D) 3/4"	FAP21 (E) 1"	FAP30 (G) 1-1/2"
DP4-13ZN	17000 N		4				



DRAWING



CONFIGURATIONS

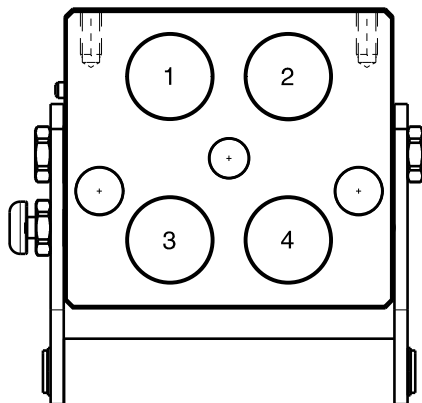

Possible configurations		
Pos	Coupling size	Predisposition for electrical connector
1	FAP13ZN	-
2	FAP13ZN	YES
3	FAP13ZN	YES
4	FAP13ZN	-

MultiCoupling (couplings included)		
Code	Name	Description
870012007	MULTI COMPLETE DP4 4B	4 FAP13 3/4 BSP - CAP
870012008	MULTI COMPLETE DP4 4B	4 FAP13 1/2 BSP - CAP
870012009	MULTI COMPLETE DP4 4B	4 FAP13 1/2 NPT - CAP
870012107	MULTI FIX DP4 4B	4 FAP13 3/4 BSP
870012108	MULTI FIX DP4 4B	4 FAP13 1/2 BSP
870012207	MULTI MOBILE DP4 4B	4 FAP13 3/4 BSP
870012208	MULTI MOBILE DP4 4B	4 FAP13 1/2 BSP

MultiCoupling spare parts (couplings not included)	
Code	Name
806000350	MULTI FIX EMPTY DP4 4B-2EC
806000351	MULTI MOBILE EMPTY DP4 4B-2EC
815606282	CAP FIX MULTICOUPLING DP 125x114
815606283	PARKING STATION MOBILE MULTICOUPLING DP 125x114
815701085	KIT NR.1 COMPLETE LEVER GROUP DP

Custom configurations available upon request

Fixed and mobile multicoupling

2,0 Kg and 1,0 Kg

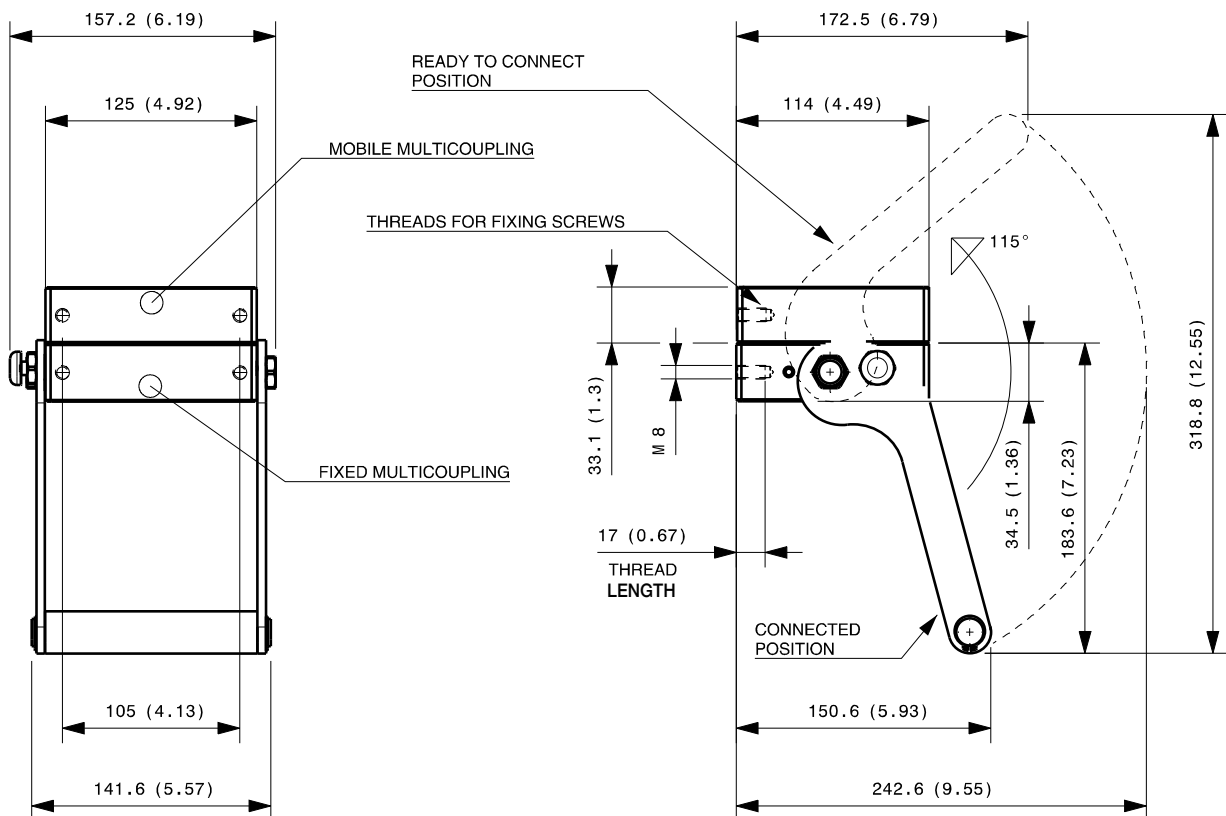

Dimensions in millimeters (inch)

Cap for fixed multicoupling 1,0 Kg

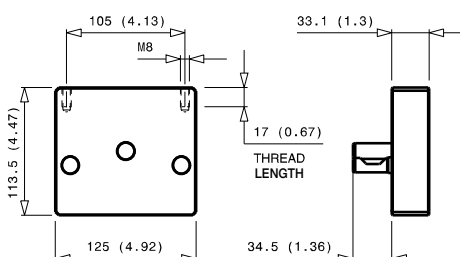

Parking station for mobile multicoupling 1,2 Kg

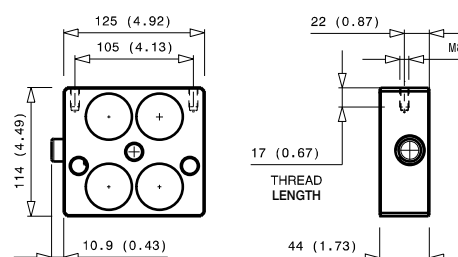

DP6 4A-2EC

Previous description	Max. Resistance Body size	FAP9 (A) 3/8"	FAP13 (B) 1/2"	FAP15 (C) 5/8"	FAP17 (D) 3/4"	FAP21 (E) 1"	FAP30 (G) 1-1/2"
DP6-9ZN	17000 N	4	A				



DRAWING



CONFIGURATIONS

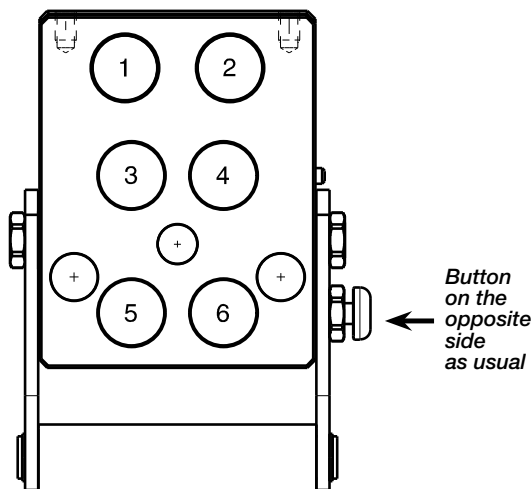

Possible configurations		
Pos	Coupling size	Predisposition for electrical connector
1	-	YES
2	-	YES
3	FAP9AZN	-
4	FAP9AZN	-
5	FAP9AZN	-
6	FAP9AZN	-

MultiCoupling (couplings included)

Code	Name	Description
870011021	MULTI COMPLETE DP6 4A	2 FAP9A 3/8 BSP - 2 FAP9A 1/2 BSP - CAP
870011121	MULTI FIX DP6 4A	2 FAP9A 3/8 BSP - 2 FAP9A 1/2 BSP
870011221	MULTI MOBILE DP6 4A	2 FAP9A 3/8 BSP - 2 FAP9A 1/2 BSP

MultiCoupling spare parts (couplings not included)

Code	Name
806000352	MULTI FIX EMPTY DP6 4A-2EC
806000353	MULTI MOBILE EMPTY DP6 4A-2EC
815606292	CAP FIX MULTICOUPLING DP 134x105
815606285	PARKING STATION MOBILE MULTICOUPLING DP 135x105
815701081	KIT NR.1 COMPLETE LEVER GROUP DP

Custom configurations available upon request

Fixed and mobile multicoupling

1,7 Kg and 1,0 Kg

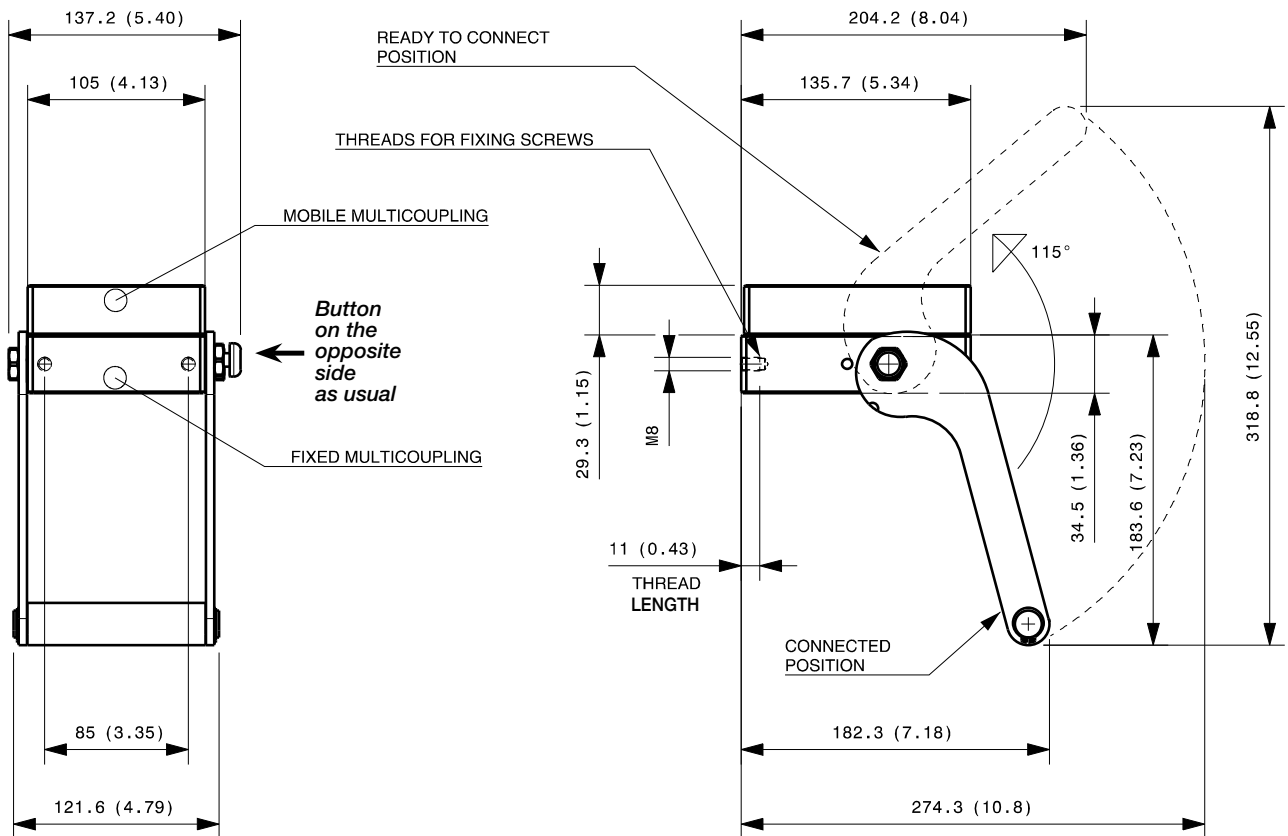

Dimensions in millimeters (inch)

Cap for fixed multicoupling 1,0 Kg

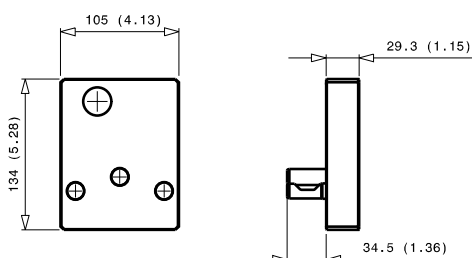

Parking station for mobile multicoupling 1,2 Kg

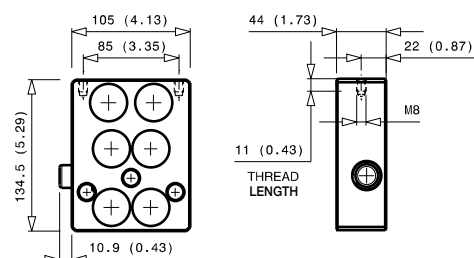

DP6 2A-4D-2EC

Previous description	Max. Resistance	FAP9 (A)	FAP13 (B)	FAP15 (C)	FAP17 (D)	FAP21 (E)	FAP30 (G)
Body size		3/8"	1/2"	5/8"	3/4"	1"	1-1/2"
DP6AD	23000 N	2	D		4		



DRAWING

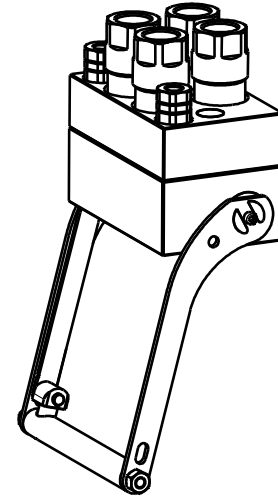

CONFIGURATIONS

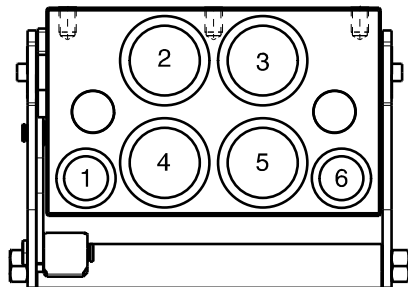

↑
Button
on the lever

Possible configurations		
Pos	Coupling size	Predisposition for electrical connector
1	FAP9DZN	YES *
2	FAP17ZN	-
3	FAP17ZN	-
4	FAP17ZN	-
5	FAP17ZN	-
6	FAP9DZN	YES *

* - Maximum hose diameter for FAP9: Ø16 (1.33),
in case of bigger hose use a longer adaptor.

MultiCoupling (couplings included)

Code	Name	Description
870008023	MULTI COMPLETE DP6 2A-4D	2 FAP9D 3/8 BSP - 4 FAP17 1 BSP - CAP
870008123	MULTI FIX DP6 2A-4D	2 FAP9D 3/8 BSP - 4 FAP17 1 BSP
870008223	MULTI MOBILE DP6 2A-4D	2 FAP9D 3/8 BSP - 4 FAP17 1 BSP

MultiCoupling spare parts (couplings not included)

Code	Name
806000382	MULTI FIX EMPTY DP6 2A-4D-2EC
806000383	MULTI MOBILE EMPTY DP6 2A-4D-2EC
815606290	CAP FIX MULTICOUPLING DP 191x118
815606291	PARKING STATION MOBILE MULTICOUPLING DP 190x120
815701089	KIT NR.1 COMPLETE LEVER GROUP DP

Custom configurations
available upon request

Fixed and mobile multicoupling

4,5 Kg and 2,2 Kg

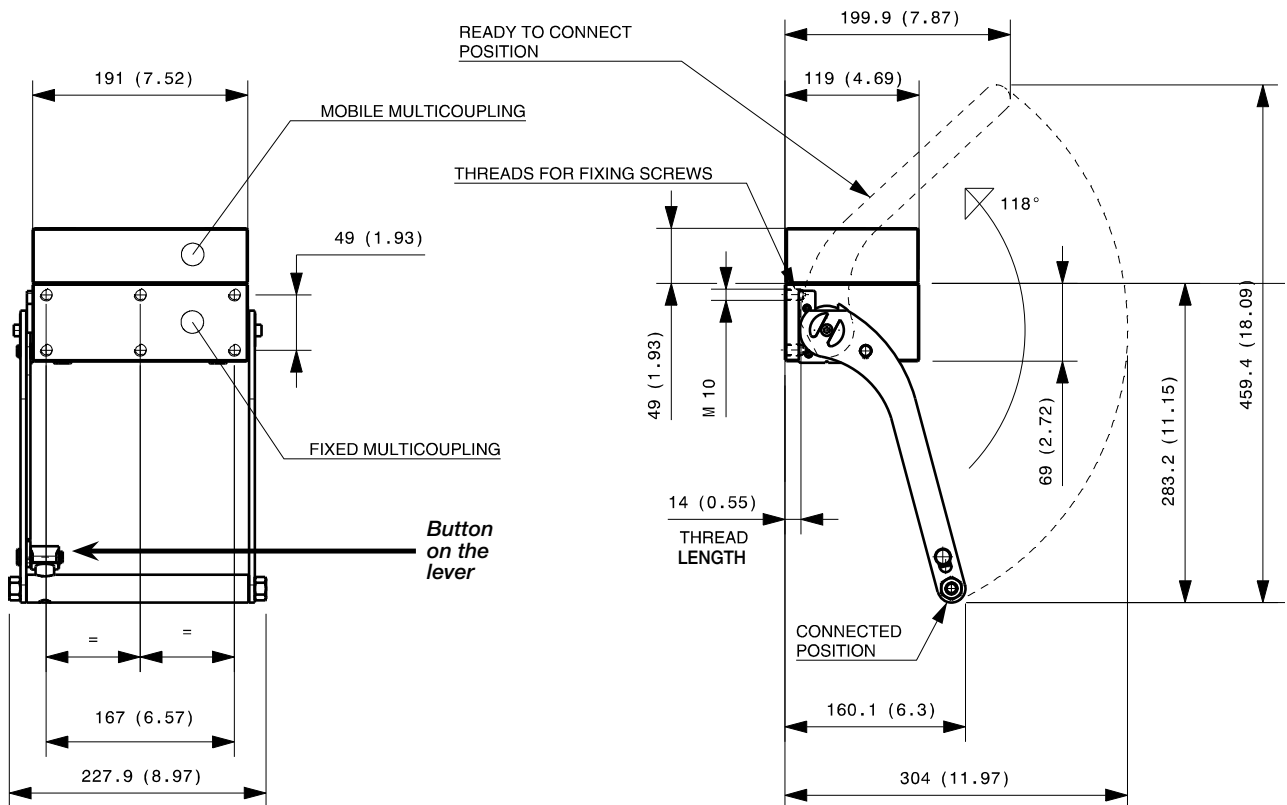

Dimensions in millimeters (inch)

Cap for fixed multicoupling 2,8 Kg

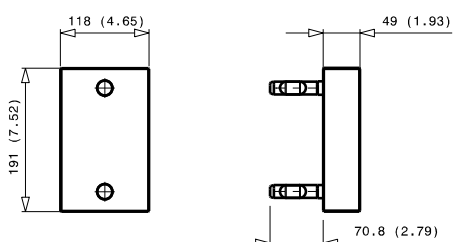

Parking station for mobile multicoupling 2,5 Kg

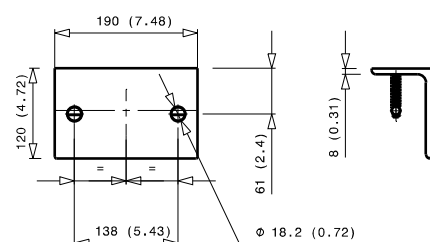

CENTRALA ELBLĄG

Ul. Rawska 19B
82-300 Elbląg

tel. /+48/ 55 625 51 00

fax /+48/ 55 625 51 01

Dział Handlowy

tel. /+48/ 55 625 51 51

elblag@hydropress.pl



www.hydropress.pl

ODDZIAŁ GDAŃSK

tel. /+48/ 55 625 51 21

fax /+48/ 55 625 51 22

ODDZIAŁ RUMIA

tel. /+48/ 58 679 34 15

fax /+48/ 55 625 51 25

ODDZIAŁ TYCHY

tel. /+48/ 32 787 52 88

fax /+48/ 55 625 51 38

ODDZIAŁ OLSZTYN

tel. /+48/ 89 532 01 05

fax /+48/ 89 715 21 42

ODDZIAŁ WARSZAWA

tel. /+48/ 22 468 86 97

fax /+48/ 55 625 51 32

BIURO WE WROCŁAWIU

tel. /+48/ 782 838 000

fax /+48/ 55 625 51 35

BIURO W KIELCACH

tel. /+48/ 885 995 501

fax /+48/ 55 625 51 01

BIURO W KRAKOWIE

tel. /+48/ 885 995 019

fax /+48/ 55 625 51 01

BIURO W OPOLU

tel. /+48/ 885 995 011

fax /+48/ 55 625 51 01

BIURO W BYDGOSZCZY

tel. /+48/ 790 222 771

fax /+48/ 55 625 51 01

BIURO W BIAŁYMSTOKU

tel. /+48/ 89 532 01 05

fax /+48/ 89 715 21 42

BIURO W ŁODZI

tel. /+48/ 609 221 421

fax /+48/ 89 715 21 42